

SIEMENS

SIMATIC

ET 200S
Technological Functions

Operating Instructions

Preface	1
1Count24V	2
1Count5V	3
1SSI	4
2PULSE	5

Legal information

Warning notice system

This manual contains notices you have to observe in order to ensure your personal safety, as well as to prevent damage to property. The notices referring to your personal safety are highlighted in the manual by a safety alert symbol, notices referring only to property damage have no safety alert symbol. These notices shown below are graded according to the degree of danger.

⚠ DANGER
indicates that death or severe personal injury will result if proper precautions are not taken.
⚠ WARNING
indicates that death or severe personal injury may result if proper precautions are not taken.
⚠ CAUTION
with a safety alert symbol, indicates that minor personal injury can result if proper precautions are not taken.
CAUTION
without a safety alert symbol, indicates that property damage can result if proper precautions are not taken.
NOTICE
indicates that an unintended result or situation can occur if the corresponding information is not taken into account.

If more than one degree of danger is present, the warning notice representing the highest degree of danger will be used. A notice warning of injury to persons with a safety alert symbol may also include a warning relating to property damage.

Qualified Personnel

The product/system described in this documentation may be operated only by **personnel qualified** for the specific task in accordance with the relevant documentation for the specific task, in particular its warning notices and safety instructions. Qualified personnel are those who, based on their training and experience, are capable of identifying risks and avoiding potential hazards when working with these products/systems.

Proper use of Siemens products

Note the following:

⚠ WARNING
Siemens products may only be used for the applications described in the catalog and in the relevant technical documentation. If products and components from other manufacturers are used, these must be recommended or approved by Siemens. Proper transport, storage, installation, assembly, commissioning, operation and maintenance are required to ensure that the products operate safely and without any problems. The permissible ambient conditions must be adhered to. The information in the relevant documentation must be observed.

Trademarks

All names identified by ® are registered trademarks of the Siemens AG. The remaining trademarks in this publication may be trademarks whose use by third parties for their own purposes could violate the rights of the owner.

Disclaimer of Liability

We have reviewed the contents of this publication to ensure consistency with the hardware and software described. Since variance cannot be precluded entirely, we cannot guarantee full consistency. However, the information in this publication is reviewed regularly and any necessary corrections are included in subsequent editions.

Table of contents

1	Preface	7
2	1Count24V	9
2.1	Product Overview.....	9
2.2	Isochronous Mode	12
2.3	Brief instructions on commissioning the 1Count24V	13
2.4	Terminal Assignment Diagram.....	16
2.5	Operating modes and application areas of the 1Count24V	17
2.6	Count Modes.....	19
2.6.1	Overview	19
2.6.2	Endless Counting	21
2.6.3	Once-Only Counting	23
2.6.4	Periodic Counting.....	26
2.6.5	Behavior of the Digital Input.....	29
2.6.6	Gate Functions in Count Modes	30
2.6.7	Latch Function	32
2.6.8	Synchronization.....	35
2.6.9	Behavior Types of the Outputs in Count Modes.....	37
2.6.10	Assignment of the Feedback and Control Interface for the Count Modes.....	45
2.6.11	Parameter Assignment for the Count Modes.....	52
2.7	Measurement Modes	54
2.7.1	Overview	54
2.7.2	Sequence of continuous-action measurement	55
2.7.3	Frequency measurement with integration time.....	59
2.7.4	Continuous Frequency Measurement.....	61
2.7.5	Rotational speed measurement with integration time.....	63
2.7.6	Continuous Rotational Speed Measurement.....	65
2.7.7	Period measurement with integration time	67
2.7.8	Continuous Period Measurement	69
2.7.9	Gate Functions in Measurement Modes.....	72
2.7.10	Behavior of the Output in Measurement Modes	73
2.7.11	Assignment of the Feedback and Control Interfaces for the Measurement Modes	75
2.7.12	Parameter Assignment for Measurement Modes	82
2.8	Fast mode	84
2.8.1	Overview	84
2.8.2	Fast mode	85
2.8.3	Gate function in the case of fast mode	85
2.8.4	Synchronization.....	86
2.8.5	Assignment of feedback interface for fast mode.....	87
2.8.6	Assigning parameters for fast mode	89

2.9	Position feedback.....	90
2.9.1	Overview	90
2.9.2	Position Detection	92
2.9.3	Gate Functions for Position Detection	93
2.9.4	Latch Function.....	96
2.9.5	Synchronization.....	99
2.9.6	Assignment of the Feedback and Control Interface for Position Feedback.....	101
2.9.7	Assigning Parameters for Position Feedback.....	107
2.10	Evaluation of count and direction signal	108
2.11	Diagnostics.....	111
2.11.1	Diagnostics using the LED display.....	111
2.11.2	Error types.....	112
2.12	Behavior at CPU-Master-STOP	113
2.13	Technical Specifications.....	115
3	1Count5V.....	119
3.1	Product Overview.....	119
3.2	Clocked Mode	122
3.3	Brief instructions on commissioning the 1Count5V	123
3.4	Terminal Assignment Diagram.....	126
3.5	Operating modes and application areas of the 1Count5V	127
3.6	Count Modes.....	129
3.6.1	Overview	129
3.6.2	Endless Counting	131
3.6.3	Once-Only Counting.....	133
3.6.4	Periodic Counting.....	136
3.6.5	Behavior of the Digital Inputs	138
3.6.6	Gate Functions in Count Modes	139
3.6.7	Latch Function.....	141
3.6.8	Synchronization.....	143
3.6.9	Behavior of the Outputs in Count Modes.....	147
3.6.10	Assignment of the Feedback and Control Interface for the Count Modes.....	155
3.6.11	Parameter Assignment for the Count Modes.....	163
3.7	Measurement Modes	165
3.7.1	Overview	165
3.7.2	Sequence of continuous-action measurement.....	166
3.7.3	Frequency measurement with integration time	170
3.7.4	Continuous Frequency Measurement.....	172
3.7.5	Rotational speed measurement with integration time.....	175
3.7.6	Continuous Rotational Speed Measurement	177
3.7.7	Period measurement with integration time.....	180
3.7.8	Continuous Period Measurement	182
3.7.9	Gate Functions in Measurement Modes.....	185
3.7.10	Behavior of the Outputs in Measurement Modes	186
3.7.11	Assignment of the Feedback and Control Interfaces for the Measurement Modes.....	188
3.7.12	Parameter Assignment for Measurement Modes	195

3.8	Fast mode	197
3.8.1	Overview	197
3.8.2	Fast mode	198
3.8.3	Gate function in the case of fast mode	198
3.8.4	Synchronization.....	199
3.8.5	Assignment of feedback interface for fast mode.....	201
3.8.6	Assigning parameters for fast mode	203
3.9	Position feedback.....	204
3.9.1	Overview	204
3.9.2	Position detection.....	206
3.9.3	Gate Functions for Position Detection	207
3.9.4	Latch Function	210
3.9.5	Synchronization.....	213
3.9.6	Assignment of the Feedback and Control Interface for Position Feedback	215
3.9.7	Assigning Parameters for Position Feedback.....	221
3.10	Evaluation of count and direction signal	222
3.11	Diagnostics.....	224
3.11.1	Diagnostics using the LED display	224
3.11.2	Error types.....	225
3.12	Behavior at CPU-Master-STOP	226
3.13	Technical Specifications	228
4	1SSI.....	231
4.1	Product Overview.....	231
4.2	Isochronous Mode	233
4.3	Example: Starting 1SSI.....	234
4.4	Terminal Assignment Diagram.....	237
4.5	Configuring standard mode and fast mode.....	239
4.6	Functions of the 1SSI.....	240
4.6.1	Overview of 1SSI functions.....	240
4.6.2	Encoder Value Detection	241
4.6.3	Gray/Binary Converter	242
4.6.4	Transmitted Encoder Value and Standardization	242
4.6.5	Detection of Direction and Reversal of the Direction of Rotation	244
4.6.6	Comparator (Only in Standard Mode).....	245
4.6.7	Latch Function (Only in Standard Mode).....	247
4.6.8	Error Detection in Standard Mode	249
4.6.9	Error Detection in Fast Mode	249
4.7	Behavior at CPU/master STOP	250
4.8	Setting parameters for the 1SSI.....	251
4.9	Diagnostics.....	254
4.9.1	Diagnostics using the LED display	254
4.9.2	Error types.....	255
4.10	Control and Feedback Interfaces in Standard Mode	256
4.11	Feedback Interface in Fast Mode	259
4.12	Technical Specifications	261

5	2PULSE	265
5.1	Product Overview.....	265
5.2	Isochronous mode.....	267
5.3	Example: Starting 2PULSE.....	268
5.4	Modes and Functions.....	271
5.4.1	Overview.....	271
5.4.2	"Pulse output" operating mode.....	273
5.4.3	"Pulse width modulation" operating mode.....	279
5.4.4	"Pulse train" operating mode.....	289
5.4.5	"On/Off-delay" operating mode.....	295
5.4.6	"Frequency output" operating mode.....	303
5.4.7	Sequence counter.....	309
5.4.8	Function: Measurement of current.....	310
5.4.9	Function: Direct Control of the DO Digital Output.....	311
5.4.10	Function: Error Detection/Diagnostics.....	313
5.4.11	Parallel connection of both channels.....	315
5.4.12	Behavior at CPU-Master-STOP.....	317
5.5	Parameter assignment and compatibility.....	318
5.5.1	Configuring the 2PULSE.....	318
5.5.2	Compatibility of the 2PULSE with predecessor versions.....	320
5.6	Diagnostics.....	321
5.6.1	Diagnostics using the LED display.....	321
5.6.2	Error types.....	322
5.7	Application Examples.....	323
5.7.1	Overview.....	323
5.7.2	Example: Filling Liquids.....	324
5.7.3	Example: Heating a Liquid.....	328
5.7.4	Example: Packing Piece Goods.....	332
5.7.5	Example: Applying a Protective Layer.....	337
5.7.6	Current regulation of a valve.....	341
5.8	Technical Specifications of the 2PULSE, Terminal Assignment.....	347
5.9	Technical Specifications for Programming, Reference Lists.....	353
	Index	359

Preface

How this Manual Is Structured...

This manual is supplementary to the *ET 200S Distributed I/O System* operating instructions.

The ET 200S Distributed I/O System

(<http://support.automation.siemens.com/WW/view/en/1144348>) operating instructions provide comprehensive information pertaining to the hardware configuration, installation, wiring, commissioning, diagnostics and technical specifications of the ET 200S distributed I/O system.

This manual provides a description of functions and the technical specifications of the ET 200S modules for technological functions: 1Count24V, 1Count5V, 1SSI and 2PULSE.

How to Find Your Way Around

At the beginning of each section you will find a **Product Overview**, which lists the features and applications of the module described. You will also find the order number of the module and the name and release of the software required. For the current GSD file, go to:

- <http://www.automation.siemens.com/csi/gsd>

In each section you will then find a section with the heading **Brief Instructions on Commissioning**. These brief instructions tell you in a series of short steps how to install and configure the module, how to integrate it in your use program, and how to test it in your user program.

Index

The index contains keywords that come up in the manual.

Standards and approvals

For information about standards and approvals, refer to the section "General technical specifications" in the ET 200S Distributed I/O System (<http://support.automation.siemens.com/WW/view/en/1144348>) operating instructions.

Recycling and disposal

The ET 200S 1Count24V, ET 200S 1Count5V, ET 200S 1SSI and ET 200S 2PULSE modules can be recycled due to the non-toxic materials from which they are assembled. For environmentally sustainable recycling and disposal of your old device, contact a certified disposal service for electronic scrap.

Additional support

If you have any further questions about the use of products described in this manual and do not find the right answers here, contact your local Siemens representative (<http://www.siemens.com/automation/partner>):

A guide to the technical documentation for the various products and systems is available on the Internet:

- SIMATIC Guide manuals (<http://www.siemens.com/simatic-tech-doku-portal>)

The online catalog and online ordering systems are also available on the Internet:

- A&D Mall (<http://www.siemens.com/automation/mall>)

Training center

To help you get started with automation technology and systems, we offer a variety of courses. Contact your regional Training Center or the central Training Center in D-90327 Nuremberg, Germany.

- Internet: SITRAIN homepage (<http://www.sitrain.com>)

Technical Support

You can access technical support for all A&D projects via the following:

- Online support request form: (<http://www.siemens.com/automation/support-request>)

Service & Support on the Internet

In addition to our documentation, we offer a comprehensive online knowledge base on the Internet at:

Industry Automation and Drive Technologies - Homepage
(<http://www.siemens.com/automation/service&support>)

There you will find the following information, for example:

- The newsletter that provides up-to-date information on your products.
- The documents you need via our Search function in Service & Support.
- A forum for global information exchange by users and specialists.
- Your local partner for Automation and Drives.
- Information about on-site service, repairs, and spare parts. Much more can be found under "Services".

1Count24V

2.1 Product Overview

Order Number

6ES7 138-4DA04-0AB0

Compatibility

The 1Count24V with the order number 6ES7 138-4DA04-0AB0 replaces the 1Count24V/100kHz with the order number 6ES7 138-4DA03-0AB0 with full compatibility. In STEP 7 version V5.3 SP2 and later, you can use it in non-isochronous and isochronous modes.

Features

- Connection of a pulse generator to count 24 V signals up to a frequency of 100 kHz.
- Can be operated using terminal modules TM-E15S24-01 and TM-E15S26-A1
- Isochronous mode
- Modified user data interface ¹

¹ Instead of 8 bytes of input data and 8 bytes of output data, 12 bytes of input data and 6 bytes of output data are used, provided the IM 151 supports this.

The following IM 151 modules support this function:

- IM151-1/Standard order no. 6ES7 151-1AA04-0AB0 and higher
- IM151-1/HF order no. 6ES7 151-1BA01-0AB0 and higher
- Operating modes of the 1Count24V:
 - Counting modes:**
 - Count continuously
 - Count once
 - Periodic Counting
 - Measuring modes:**
 - Frequency with integration time
 - Rotational speed measurement
 - Period measurement

Position feedback:

- Position detection
- Fast mode
- Gate control, synchronization or latch function via digital input (P or M switch)
- One real digital output for direct control or output of the comparison result
- One virtual digital output
- Firmware update ¹
- Identification data ¹

¹ The following IM 151 modules support this function: IM 151-1 Standard: As of 6ES7151-1AA04-0AB0 and IM 151-1 High Feature: As of 6ES7 151-1BA01-0AB0

Connectable Counting Signals

The 1Count24V can count the signals of the following encoders:

- 24 V pulse encoder with direction level
- 24 V pulse encoder without direction level
- 24 V incremental encoder with two tracks that are 90° out of phase (rotary encoder).

Adjustment During Operation

- Counting modes
 - You can change the function and behavior of the digital outputs during operation
- Measuring modes
 - You can change the function of the DO1 digital output during operation
 - You can change the integration time and the update time during operation

Configuration

In order to configure the 1Count24V use one of the following options

- STEP 7 V5.3 SP2 or higher, or
- HSP (hardware support package, available online) as of STEP 7 Version V5.2 SP1

Firmware update

In order to extend the functionality and eliminate errors, firmware updates can be downloaded to the operating system memory of the 1Count24V by means of the STEP 7 HW Config software.

Note

When you launch the firmware update, the old firmware is deleted. If the firmware update is interrupted or canceled for any reason, the 1Count24V will no longer function correctly as a result. Restart the firmware update and wait until it has completed successfully.

Identification Data ¹

- Hardware release status
- Firmware release status
- Serial number

¹See also ET 200S Distributed I/O operating instructions (<http://support.automation.siemens.com/WW/view/en/1144348>), "Identification data" section.

2.2 Isochronous mode

Note

For basic information on isochronous mode, refer to the Isochronous mode (<http://support.automation.siemens.com/WW/view/en/15218045>) function manual.

Hardware Requirements

You will require the following for the 1Count24V in isochronous mode:

- A CPU that supports isochrone mode
- PROFIBUS master or PROFINET controller that supports the constant bus cycle time
- An IM 151 that supports isochrone mode

Features

Depending on the system parameter assignment, the 1Count24V works in either non-isochronous or isochronous mode.

In isochronous mode, data communication between the bus master and 1Count24V is isochronous to the cycle.

In isochronous mode, all 8 bytes / 12 bytes of the user data interface are consistent.

If a parameter assignment error occurs, the 1Count24V does not go into isochronous mode.

If isochronous mode fails due to faults or failure/delay of global control (GC), the 1Count24V returns to isochronous mode during the next cycle without an error response.

If isochrone mode fails, the user data interface is not updated.

The T_i/T_o overlap is supported by the module in firmware version V1.0.1 and later.

2.3 Brief instructions on commissioning the 1Count24V

Introduction

These instructions guide you to a functioning application that will enable you to count the switching operations of a contact and become familiar with and check the basic hardware and software functions of the 1Count24V. The counting mode used in this example is "Count continuously".

Requirements

The following requirements must be satisfied:

- You must have put an ET 200S station on an S7 station with a DP master into operation.
- You must have the following:
 - A TM-E15S24-01 terminal module
 - A 1Count24V,
 - A momentary contact switch and the necessary wiring material

Installation, Wiring and Fitting

1. Install and wire the TM-E15S24-01 terminal module (see Figure).
2. Plug the 1Count24V into the terminal module. Detailed instructions are provided in the ET 200S Distributed I/O Device (<http://support.automation.siemens.com/WW/view/en/1144348>) operating instructions.

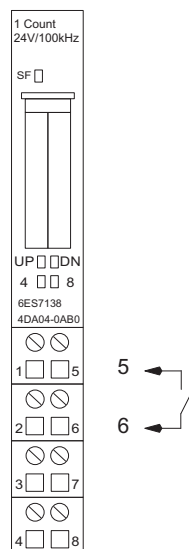

Figure 2-1 Terminal Assignment for the Example

Configuring with STEP 7 using HW Config

You must first adapt the hardware configuration of your existing ET 200S station.

1. Open the relevant project in SIMATIC Manager.
2. Open the HW Config configuration table in your project.
3. Select 1Count 24V in the hardware catalog.
 The number 6ES7 138-4DA04-0AB0 C appears in the infotext. Drag the entry to the slot at which you have mounted your 1Count24V.
4. Double-click this number to open the "Properties - 1Count 24V" tab (R-S Slot Number).
5. On the Addresses tab, you will find the addresses of the slot to which you have dragged the 1Count24V. Make a note of these addresses for subsequent programming.
6. The Parameters tab contains the default settings for the 1Count24V. Leave the default settings unchanged.
7. Save and compile your configuration, and download the configuration in STOP mode of the CPU by choosing "PLC > Download to Module".

Integration into the User Program

(not for modified user data interface)

1. Create block FC 101 and integrate it in your control program (in OB 1, for example).

This block requires the DB1 data block with a length of 16 bytes. The start address of the module in the following example is 256.

STL	Description
Block: FC101	
Network 1: Presettings	
L 0	//Delete control bits
T DB1.DBD0	
T DB1.DBD4	
SET	
S DB1.DBX4.0	//Open SW gate
Network 2: Write to the control interface	
L DB1.DBD0	//Write 6 bytes to the 1Count24V
	//Configured start address of the outputs
T PAD 256	
L DB1.DBW4	
T PAW 260	

STL	Description
Network 3: Read from the feedback interface	
	//Read 8 bytes from the 1Count24V
	//Configured start address of inputs
L PED 256	
T DB1.DBD8	
L PED 260	
T DB1.DBD12	

Testing

Use "Monitor/Modify Variables" to monitor the count value and the gate.

1. Select the "Block" folder in your project. Choose the "Insert > S7 Block > Variable Table" menu command to insert the VAT 1 variable table, and then confirm with "OK".
2. Open the VAT 1 variable table, and enter the following variables in the "Address" column:
DB1.DBD8 (current count value)
DB1.DBx13.0 (internal gate status)
3. Choose "PLC > Connect To > Configured CPU" to switch to online.
4. Choose "Variable > Monitor" to switch to monitoring.
5. Switch the CPU to RUN mode.
The "internal gate status" bit must be set.
6. Use your counting contact to generate pulses.

Result

You can now see that:

- The UP LED on the 1Count24V is on. The status of the UP LED changes with each new pulse.
- The count value in the block changes.

2.4 Terminal Assignment Diagram

Wiring Rules

The cables (terminals 1 and 5 and terminals 2 and 8) must be shielded. The shield must be supported at both ends. To do this, use the shield contact (see the ET 200S Distributed I/O System (<http://support.automation.siemens.com/WW/view/en/1144348>) operating instructions).

Terminal assignment of the 1Count24V

The tables below show the terminal assignment for the 1Count24V:

Table 2- 1 Terminal assignment of the 1Count24V

View	Terminal Assignment	Remarks
	<p>TM-E15S24-01 and 1Count24V</p>	<p>B: Direction input or track B A: Pulse input or track A 24V DC: Sensor supply M: Chassis ground DI: Digital input DO1: Digital output</p>

Pulse Generator Connection

Encoder Type	Connection	Count Direction
Pulse generator without direction indicator	24 V count pulses at terminal 5 (A)	pulses
Pulse generator with direction indicator	24 V count pulses at terminal 5 (A) and 24 V direction at terminal 1 (B)	Up, down
Pulse generator with 2 tracks that are 90° out of phase	Track A terminal 5 (A) and track B terminal 1 (B)	Up, down

2.5 Operating modes and application areas of the 1Count24V

Introduction

To begin with, decide how you want to use the 1Count24V. You can choose between the following modes:

Counting modes	Measuring modes	Position feedback	Fast mode
Count continuously	Frequency measurement	Position detection	Position feedback in short (isochronous) cycles
Count once	Rotational speed measurement		
Count periodically	Period measurement		

Parameters are assigned to the various modes. You will find the parameter lists in the descriptions of the modes. You can integrate the 1Count24V in your project in two different ways. Decide whether you want to work with a GSD file or with STEP 7.

Integrate 1Count24V using STEP 7

Integrate 1Count24V using STEP 7 (in isochronous and non-isochronous mode)			
Select an entry from the hardware catalog that corresponds to the operating mode you want.			
For counting modes, select the "1Count24V Counting Mode V2.0" entry	For measuring modes, select the "1Count24V Measuring Mode V2.0" entry	For position detection, select the "1Count24V Position Detection V2.0" entry	For Fast Mode, select the "1 COUNT24V Fast Mode V2.0" entry
The number 6ES7 138-4DA04-0AB0 C appears in the infotext. Drag the entry to the slot at which you have mounted your 1Count24V.	The number 6ES7 138-4DA04-0AB0 M appears in the infotext. Drag the entry to the slot at which you have mounted your 1Count24V.	The number 6ES7 138-4DA04-0AB0 W appears in the infotext. Drag the entry to the slot at which you have mounted your 1Count24V.	The number 6ES7 138-4DA04-0AB0 F appears in the infotext. Drag the entry to the slot at which you have mounted your 1Count24V.
Select the parameters.			

Integrate the 1Count24V with the GSD file

Integrate the 1Count24V with the GSD file (only in non-isochronous mode)		
Select an entry in the GSD file that corresponds to the operating mode you want.		
For counting modes, select C 6ES7 138-4DA04-0AB0 1CNT24V	For measuring modes, select M 6ES7 138-4DA04-0AB0 1CNT24V	For position feedback, select W 6ES7 138-4DA04-0AB0 1CNT24V
Select the parameters.		

Note

Fast mode is designed for use in especially short isochronous cycles. You need STEP 7 to configure isochronous operation.

2.6 Count Modes

2.6.1 Overview

Principle

The counting modes are used in counting applications (for counting of items, for example). For the "Counting modes" parameter, you can select from the following modes:

- Count continuously (for position detection with incremental encoders, for example)
- Count once (for counting items up to a maximum limit, for example)
- Count periodically (in applications with recurring counting operations, for example)

To run one of these modes, you have to assign parameters to the 1Count24V (see section "Parameter Assignment for the Count Modes (Page 163)").

Maximum Count Range

The high counting limit is +2147483647 ($2^{31} - 1$).

The low counting limit is -2147483648 (-2^{31}).

Load Value

You can specify a load value for the 1Count24V.

This load value is either applied directly as the new count value (LOAD_VAL) or it is applied as the new count value when the following events occur (LOAD_PREPARE):

In the Count once and Count periodically counting modes:

- The low or high counting limit is reached when a main count direction is not assigned.
- The assigned high counting limit is reached when the main count direction is up.
- Zero is reached when the main count direction is down.

In all counting modes:

- The counting operation is started by a SW gate or HW gate (if the counting operation is continued, the load value is not applied).
- Synchronization
- Latch and retrigger

Gate Control

To control the 1Count24V, you have to use the gate functions.

Main Count Direction

With the main count direction, you assign which RESET states (status following parameter assignment) the load value and count value can take on. It is thus possible to create incrementing or decrementing count applications. The assigned main count direction has no effect on the direction evaluation when the count pulses are detected.

RESET States of the Following Values after Parameter Assignment

Table 2- 2 RESET States

Value	Main count direction	RESET state
Load value	None	0
	Up	0
	Down	Assigned high counting limit
Count value	None	0
	Up	0
	Down	Assigned high counting limit
Comparison value 1 and 2	None	0
	Up	0
	Down	Assigned high counting limit
Latch value	None	0
	Up	0
	Down	Assigned high counting limit

Isochrone Mode

In isochronous mode, the 1Count24V accepts control bits and control values from the control interface in each bus cycle and reports back the response in the same cycle.

In each cycle, the 1Count24V transfers the count or latch value that was valid at time T_i and the status bits valid at time T_i .

A count controlled by hardware input signals can only be transferred in the same cycle if the input signal occurred before time T_i .

(See Isochronous Mode (<http://support.automation.siemens.com/WW/view/en/15218045>) function manual)

2.6.2 Endless Counting

Definition

In this mode, the 1Count24V counts continuously starting from the load value:

- If the 1Count24V reaches the high count limit when counting up, and another count pulse then comes, it will jump to the low count limit and continue counting from there without losing a pulse.
- If the 1Count24V reaches the low count limit when counting down, and another count pulse then comes, it will jump to the high count limit and continue counting from there without losing a pulse.
- The high counting limit is set to $+2147483647$ ($2^{31} - 1$).
- The low counting limit is set to -2147483648 (-2^{31}).

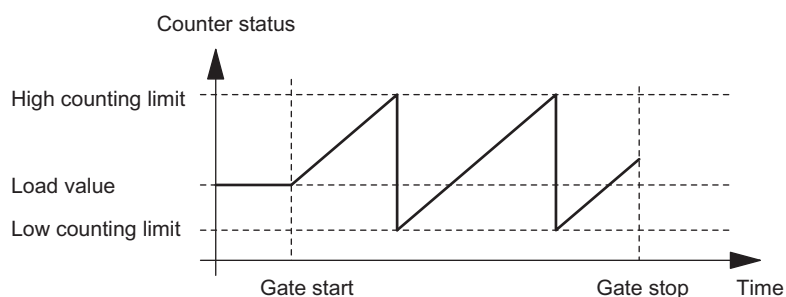

Figure 2-2 Count Continuously with Gate Function

Function of the Digital Input

For the "Function DI" parameter, select one of the following functions for the digital input:

- Input
- HW gate (see section "Gate Functions in Count Modes (Page 30)")
- Latch function (see section "Latch Function (Page 32)")
- Synchronization (see section "Synchronization (Page 35)")

Function of the Digital Outputs

For the "Function DO1" and "Function DO2" parameters, select one of the following functions for each digital output:

- Output, no switching through comparator
- Activation at a counter status greater than or equal to the comparison value
- Activation at a counter status less than or equal to the comparison value
- Pulse on reaching the comparison value
- Switch at comparison values (DO1 only)

(see section "Behavior Types of the Outputs in Count Modes (Page 37)")

Influencing the Behavior of the Digital Outputs via:

- Hysteresis
- Pulse duration

(see section "Behavior Types of the Outputs in Count Modes (Page 37)")

Changing values during operation

The following values can be changed during operation:

- Load value (LOAD_PREPARE)
- Counter status (LOAD_VAL)
- Comparison value 1 (CMP_VAL1)
- Comparison value 2 (CMP_VAL2)
- Function and behavior of the digital outputs (C_DOPARAM)

(see section "Behavior Types of the Outputs in Count Modes (Page 37)" and "Assignment of the Feedback and Control Interface for the Count Modes (Page 45)")

2.6.3 Once-Only Counting

Definition

In this mode, the 1Count24V counts once only, depending on the assigned main count direction ("Main count direction" parameter).

- When there is no main count direction:
 - Counts starting from the load value.
 - Counts up or down.
 - The count limits are fixed at the maximum count range.
 - If the high or low counting limit is violated, the gate is closed automatically, and the counter jumps to the respective counting limit.
- When the main count direction is up:
 - Counts starting from the load value.
 - Counts up or down.
 - When the high count limit is reached, the counter jumps to the load value and the gate is closed.
 - The high count limit can be assigned parameters, and the load value has RESET state of 0 and can be changed.
- When the count direction is down:
 - Counts starting from the load value.
 - Counts up or down.
 - When the low counting limit is reached, the 1Count24V jumps to the load value and the gate is closed.
 - The low count limit is fixed at 0, and the load value can be assigned parameters (parameter: high count limit) and can be changed.

The internal gate is automatically closed in the event of an overflow/underflow at the count limits. To restart counting, you have to open the gate again.

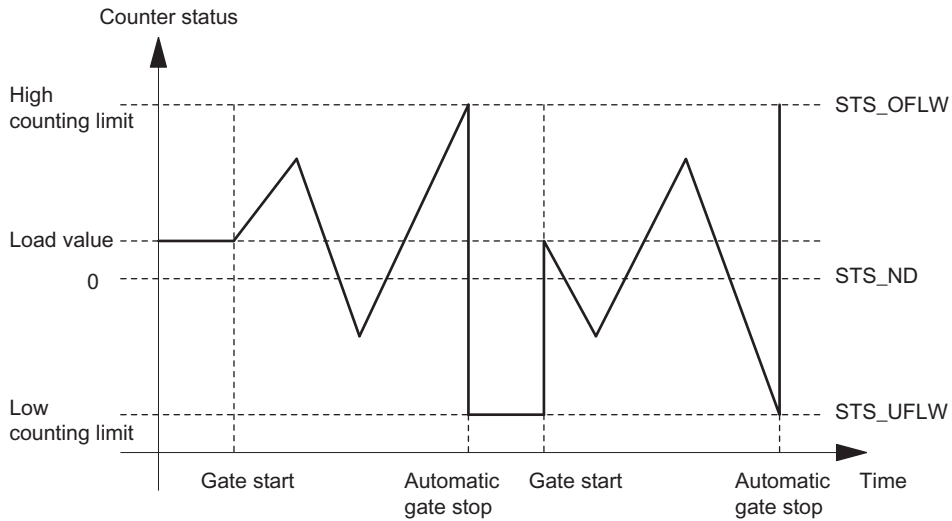

Figure 2-3 Count Once Without Main Count Direction; Canceling Gate Function

With an interrupting gate function, the 1Count24V remains at the underflow when the gate is started.

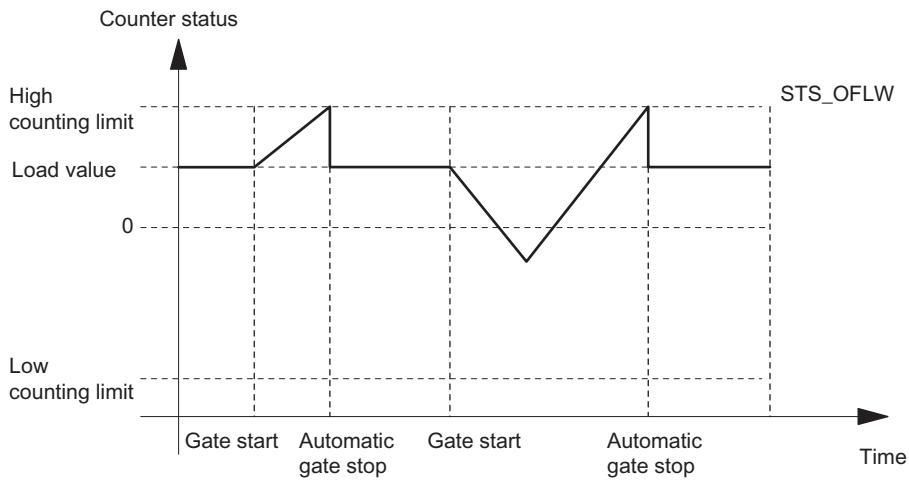

Figure 2-4 Count Once with Up as the Main Count Direction

Function of the Digital Input

For the "Function DI" parameter, select one of the following functions for the digital input:

- Input
- HW gate (see section "Gate Functions in Count Modes (Page 30)")
- Latch function (see section "Latch Function (Page 32)")
- Synchronization (see section "Synchronization (Page 35)")

Function of the Digital Outputs

For the "Function DO1" and "Function DO2" parameters, select one of the following functions for each digital output:

- Output, no switching through comparator
- Activation at a counter status greater than or equal to the comparison value
- Activation at a counter status less than or equal to the comparison value
- Pulse on reaching the comparison value
- Switch at comparison values (DO1 only)

(see section "Behavior Types of the Outputs in Count Modes (Page 37)")

Influencing the behavior of the digital outputs via:

- Hysteresis
- Pulse duration

(see section "Behavior Types of the Outputs in Count Modes (Page 37)")

Values that Can Be Changed during Operation:

- Load value (LOAD_PREPARE)
- Counter status (LOAD_VAL)
- Comparison value 1 (CMP_VAL1)
- Comparison value 2 (CMP_VAL2)
- Function and behavior of the digital outputs (C_DOPARAM)

(see section "Behavior Types of the Outputs in Count Modes (Page 37)" and "Assignment of the Feedback and Control Interface for the Count Modes (Page 45)")

2.6.4 Periodic Counting

Definition

In this mode, the 1Count24V counts periodically, depending on the assigned main count direction ("Main count direction" parameter).

- When there is no main count direction:
 - Counts starting from the load value.
 - Counts up or down.
 - The count limits are fixed at the maximum count range.
 - In the event of an overflow or underflow at the respective count limit, the 1Count24V jumps to the load value and continues counting from there.
- When the main count direction is up:
 - Counts starting from the load value.
 - Counts up or down.
 - The upper limit can be assigned parameters, and the load value has a RESET status of 0 and can be changed.
 - When the high count limit is reached, the 1Count24V jumps to the load value and continues counting from there.
- When the count direction is down:
 - Counts starting from the load value.
 - Counts up or down.
 - When the low count limit is reached, the 1Count24V jumps to the load value and continues counting from there.
 - The low count limit is fixed at 0, and the load value can be assigned parameters (parameter: high counting limit) and can be changed.

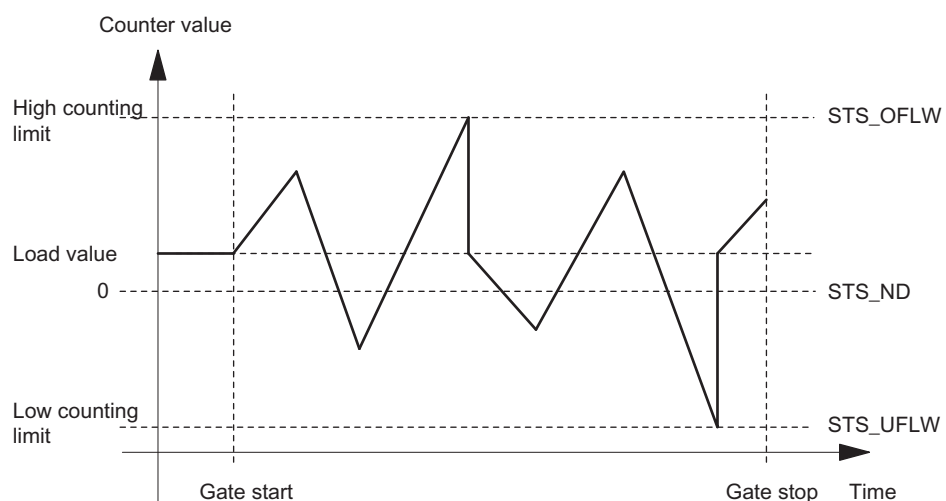

Figure 2-5 Periodic Counting without a Main Count Direction

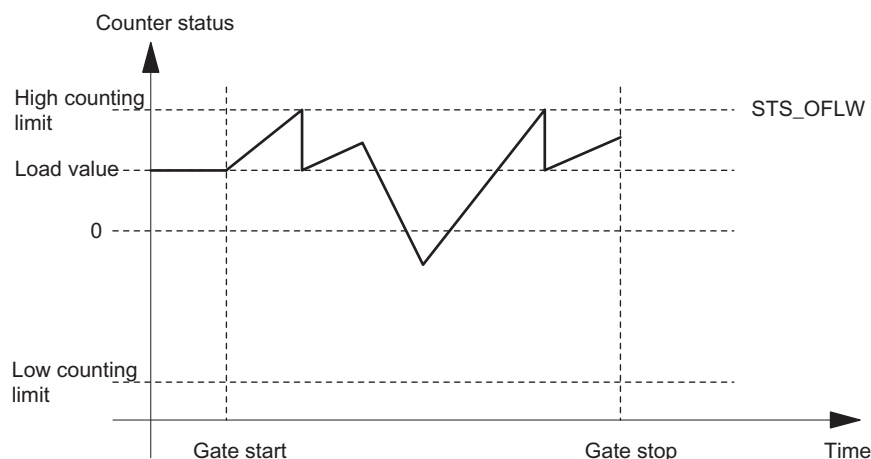

Figure 2-6 Periodic Counting with Up as the Main Count Direction

Function of the Digital Input

For the "Function DI" parameter, select one of the following functions for the digital input:

- Input
- HW gate (see section "Gate Functions in Count Modes (Page 30)")
- Latch function (see section "Latch Function (Page 32)")
- Synchronization (see section "Synchronization (Page 35)")

Function of the Digital Outputs

For the "Function DO1" and "Function DO2" parameters, select one of the following functions for each digital output:

- Output, no switching through comparator
- Activation at counter status greater than or equal to the comparison value
- Activation at a counter status less than or equal to the comparison value
- Pulse on reaching the comparison value
- Switch at comparison values (DO1 only)

(see section "Behavior Types of the Outputs in Count Modes (Page 37)")

Influencing the Behavior of the Digital Outputs via:

- Hysteresis
- Pulse duration

(see section "Behavior Types of the Outputs in Count Modes (Page 37)")

Values that Can Be Changed During Operation

- Load value (LOAD_PREPARE)
- Counter status (LOAD_VAL)
- Comparison value 1 (CMP_VAL1)
- Comparison value 2 (CMP_VAL2)
- Function and behavior of the digital outputs (C_DOPARAM)

(see sections "Behavior Types of the Outputs in Count Modes (Page 37)" and "Assignment of the Feedback and Control Interface for the Count Modes (Page 45)")

2.6.5 Behavior of the Digital Input

Digital input of the 1Count24V

The DI digital input can be operated with different sensors (P switch and series mode or M switch).

Note

If you have selected the 24V M switch setting for the "Sensor A, B, DI" parameter, you must use M-switching sensors.

The level of the digital input for the "Function DI = HW gate" configuration with the parameter "Input signal HW gate" can be inverted.

To filter the input signal, you can switch on a filter depending on the minimum pulse duration or the maximum signal frequency (parameter: Filter counter input A*, direction input B*, digital input DI).

The STS_DI feedback bit indicates the level of the digital input.

2.6.6 Gate Functions in Count Modes

Software Gate and Hardware Gate

The 1Count24V has two gates

- A software gate (SW gate), which is controlled by the SW_GATE control bit.
The software gate can only be opened by a positive edge of the SW_GATE control bit. It is closed when this bit is reset. Note the transfer times and run times of your control program.
- A hardware gate (HW gate), which is controlled by means of the digital input on the 1Count24V. You assign the hardware gate as the function of the digital input (Function DI "HW Gate"). It is opened on a positive edge at the digital input and closed on a negative edge.

Internal gate

The internal gate is the logical AND operation of the HW gate and SW gate. Counting is only active when the HW gate and the SW gate are open. The STS_GATE feedback bit (internal gate status) indicates this. If a HW gate has not been assigned, the setting of the SW gate is decisive. Counting is activated, interrupted, continued, and canceled by means of the internal gate. In the Count once counting mode, the internal gate is closed automatically when there is an overflow/underflow at the counting limits.

Canceling- and Interrupting-Type Gate Function

When assigning the gate function ("Gate Function" parameter), you can specify whether the internal gate is to cancel or interrupt counting. When counting is canceled, after the gate is closed and restarted, counting starts again from the beginning. When counting is interrupted, after the gate is closed and restarted, counting continues from the previous value.

The diagrams below indicate how the interrupting and canceling gate functions work:

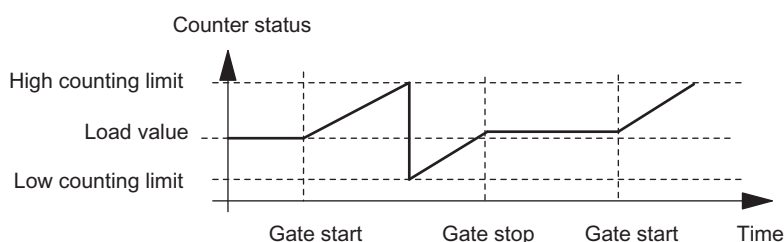

Figure 2-7 Count Continuously, Up, Interrupting Gate Function

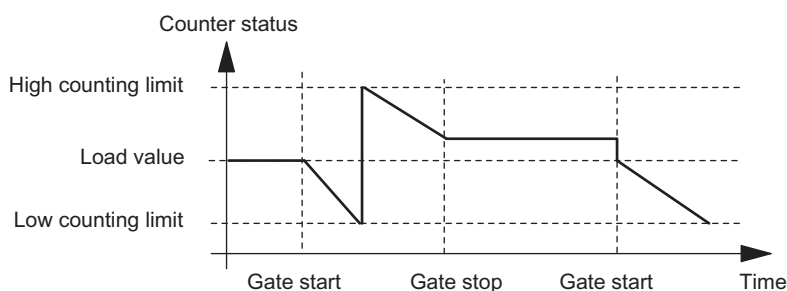

Figure 2-8 Count Continuously, Down, Canceling Gate Function

Gate Control by Means of the SW Gate Only

When the gate is opened, one of the following occurs, depending on the parameter assignment:

- Counting continues from the current count status, or
- Counting starts from the load value

If the SW gate is opened in isochronous mode in bus cycle "n" by setting the SW_GATE control bit, counting starts at time T_o in cycle "n+1". In the same cycle "n+1", the 1Count24V delivers the current count value from time T_i . (See Isochronous Mode (<http://support.automation.siemens.com/WW/view/en/15218045>) function manual)

Gate Control by Means of the SW Gate and HW Gate

If the SW gate opens when the HW gate is already open, counting continues starting from the current count status.

When the HW gate is opened, one of the following occurs, depending on the parameter assignment:

- Counting continues from the current count status, or
- Counting starts from the load value

If the SW gate is opened in isochronous mode in bus cycle "n" by setting the SW_GATE control bit, counting starts at time T_o in cycle "n+1" if the HW gate is already open at this time. If the HW gate opens between T_o and T_i in cycle "n+1", counting only starts once the HW gate is open. In both cases, the 1Count24V delivers the current count value in cycle "n+1" starting from time T_i .

2.6.7 Latch Function

Introduction

There are two latch functions:

- The Latch and Retrigger function
- The Latch function

The Latch and Retrigger Function

Requirement

In order to use this function, you must first select it with the "Latch and Retrigger on Positive Edge" parameter from the possible functions of the digital input.

Description

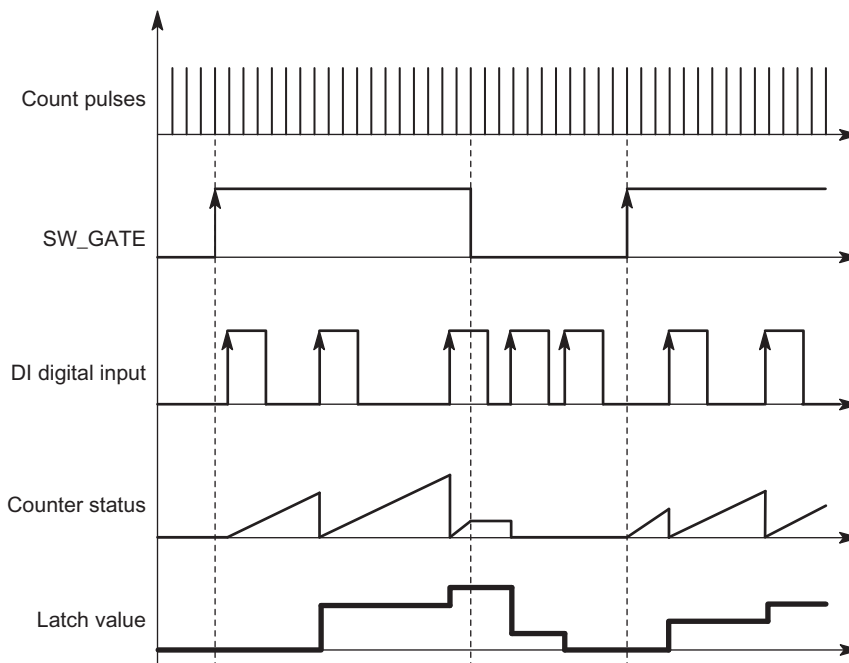

Figure 2-9 Latch and Retrigger with Load Value = 0

This function stores the current internal counter status of the 1Count24V and retriggers counting when there is a positive edge on the digital input. This means that the current internal counter status at the time of the positive edge is stored (latch value), and the 1Count24V is then loaded again with the load value, from which counting resumes.

The counting mode must be enabled with the SW gate before the function can be executed. It is started with the first positive edge on the digital input.

The stored counter status rather than the current counter status is indicated in the feedback interface. The STS_DI bit indicates the status of the latch and retrigger signal.

The latch value is preassigned with its RESET state. It is not changed when the SW gate is opened.

Direct loading of the counter does not cause the indicated stored counter status to be changed.

If you close the SW gate, counting is only interrupted; this means that when you open the SW gate again, counting is continued. The digital input DI remains active even when the SW gate is closed.

Counting is also latched and triggered in isochronous mode with each edge on the digital input. The counter status that was valid at the time of the last edge before T_i is displayed in the feedback interface.

The Latch Function

Requirement

In order to use this function, the Function DI parameter must be set to "Latch on Positive Edge".

Description

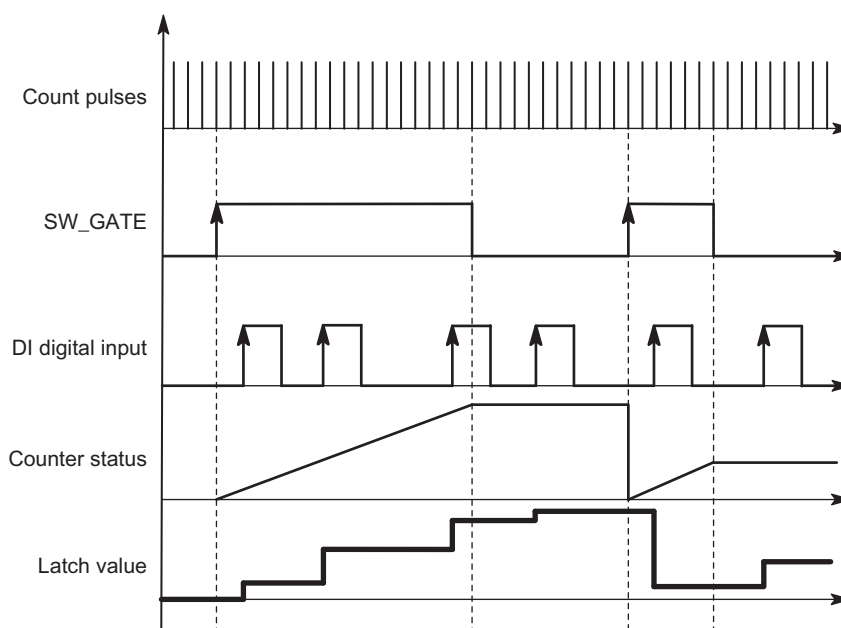

Figure 2-10 Latch with a Load Value of 0

Counter status and latch value are preassigned with their RESET states.

The counting function is started when the SW gate is opened. The 1Count24V begins at the load value.

The latch value is always the exact counter status at the time of the positive edge on the digital input DI.

The stored counter status rather than the current counter status is indicated in the feedback interface. The STS_DI bit indicates the level of the latch signal.

Direct loading of the counter does not cause the indicated stored counter status to be changed.

In isochronous mode, the counter status that was latched at the time of the last positive edge before T_i is displayed in the feedback interface.

When you close the SW gate, the effect is either canceling or interrupting, depending on the parameter assignment. The digital input DI remains active even when the SW gate is closed.

Modified User Data Interface

If the 1Count24V is inserted behind an IM 151 that supports the reading and writing of broader user data interfaces, the current count value can be read from bytes 8 to 11 of the feedback interface.

2.6.8 Synchronization

Requirement

In order to use this function, you must first select it with the "Synchronize on Positive Edge" Function DI parameter.

Description

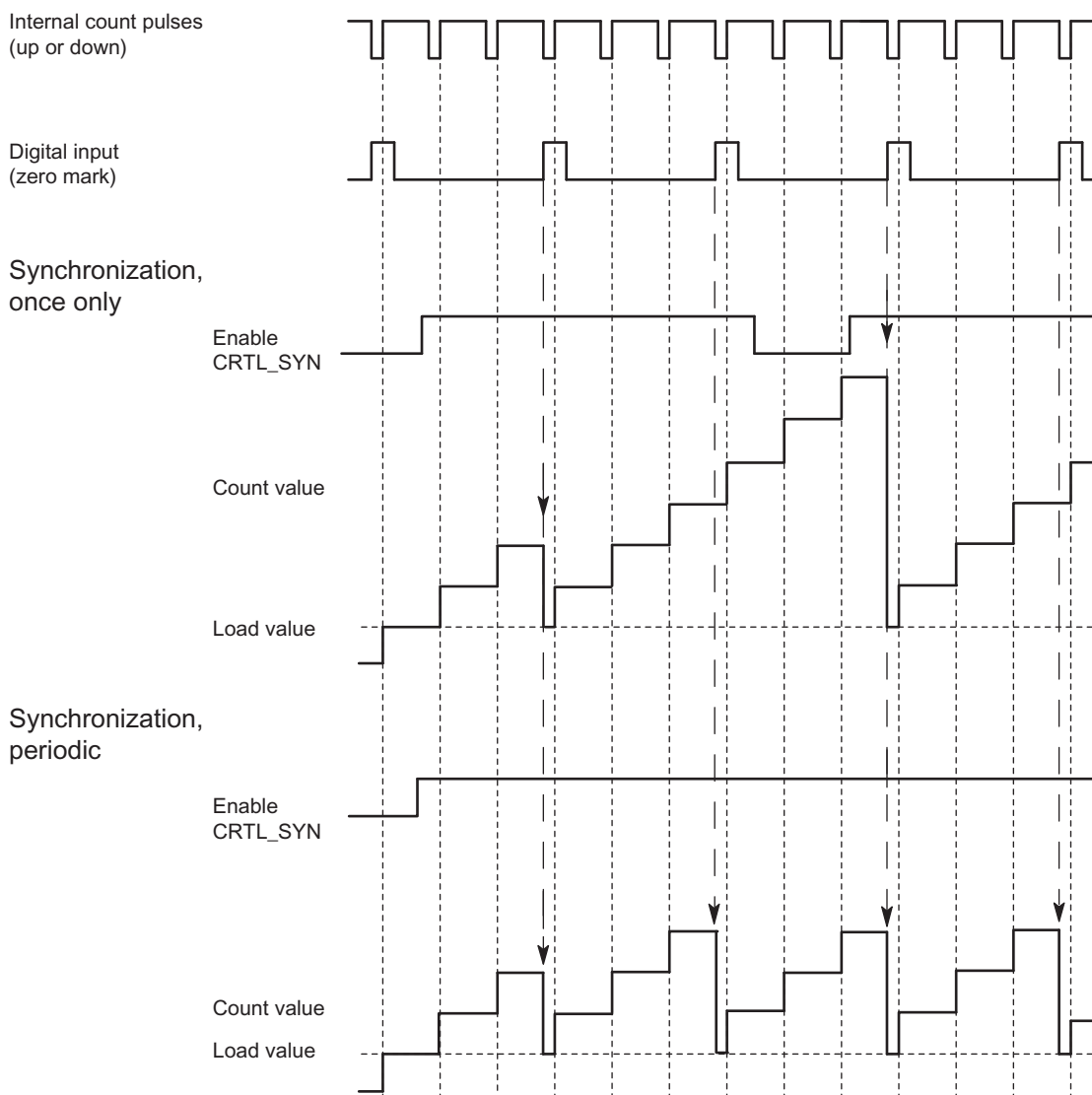

Figure 2-11 Once-Only and Periodic Synchronization

If you have configured synchronization, the rising edge of a reference signal on the input sets the 1Count24V to the load value.

You can select between once-only and periodic synchronization ("Synchronization" parameter).

The following conditions apply:

- The counting mode must have been started with the SW gate.
- The "Enable synchronization CTRL_SYN" control bit must be set.
- Synchronize once only: If the enable bit is set, the first edge loads the 1Count24V with the load value.
- Synchronization periodically: If the enable bit is set, the first and every further edge loads the 1Count24V with the load value.
- After successful synchronization, the STS_SYN feedback bit is set. It must be reset by the RES_STS control bit.
- The signal of a bounce-free switch or the zero mark of a rotary encoder can serve as the reference signal.
- The STS_DI feedback bit indicates the level of the reference signal.

In isochrone mode, the set feedback bit STS_SYN indicates that the rising edge on the digital input was between time T_i in the current cycle and time T_i in the previous cycle.

2.6.9 Behavior Types of the Outputs in Count Modes

Introduction

The 1Count24V allows you to store two comparison values, which are assigned to the digital outputs. The outputs can be activated, depending on the counter status and the comparison values. The various ways of setting the behavior of the outputs are described in this section.

Description

The 1Count24V has a real digital output and a virtual digital output that exists only as a status bit in the feedback interface.

Parameters can be assigned for both outputs ("Function DO1" and "Function DO2" parameters).

You can change the function and the behavior of the digital outputs during operation. The new function takes effect immediately.

You can choose from the following functions:

- Output
- Counter status \geq comparison value
- Counter status \leq comparison value
- Pulse on reaching the comparison value
- Switch at comparison values (DO1 only)

Output

You can switch the outputs on and off with the control bits SET_DO1 and SET_DO2.

The control bits CTRL_DO1 or CTRL_DO2 must be set for this.

You can query the status of the outputs with the status bits STS_DO1 and STS_DO2 in the feedback interface.

The status bits STS_CMP1 and STS_CMP2 indicate that the relevant output is or was switched on. These status bits retain their status until they are acknowledged. If the output is still switched, the corresponding bit is set again immediately. These status bits are also set when the control bit SET_DO1 or SET_DO2 is operated without DO1 or DO2 being enabled.

Isochronous mode: In isochronous mode, the output DO1 is switched at time T_o . The status of the virtual output DO2 is signaled at time T_i .

Counter status \leq Comparison Value and Counter Status \geq Comparison Value

If the comparison conditions are fulfilled, the respective comparator switches on the output. The status of the output is indicated by STS_DO1 and STS_DO2.

The control bits CTRL_DO1 or CTRL_DO2 must be set for this.

The comparison result is indicated by the status bits STS_CMP1 or STS_CMP2. You cannot acknowledge and thus reset these bits until the comparison conditions are no longer fulfilled.

Isochronous mode: In isochronous mode, as well, the DO1 output is switched as soon as the comparison condition is fulfilled and is therefore independent of the bus cycle. The status of the virtual output DO2 is signaled at time T_i .

Comparison Value Reached, Output Pulse

If the counter status reaches the comparison value, the comparator switches on the respective digital output for the assigned pulse duration.

The control bit CTRL_DO1 or CTRL_DO2 must be set for this.

The status bits STS_DO1 and STS_DO2 always have the status of the corresponding digital output.

The comparison result is indicated by the status bit STS_CMP1 or STS_CMP2 and cannot be reset by acknowledgment until the pulse duration has elapsed.

If a main count direction is assigned, the comparator switches only when the comparison value in the main count direction is reached.

If a main count direction is not assigned, the comparator switches when the comparison value is reached from either direction.

If the digital output is set by control bit SET_DO1 or SET_DO2, it is reset when the pulse duration has elapsed.

Isochronous mode: In isochronous mode, as well, the DO1 output is switched as soon as the comparison condition is fulfilled and is therefore independent of the bus cycle. The status of the virtual output DO2 is signaled at time T_i .

Pulse Duration when the Comparison Value is Reached

The pulse duration begins when the respective digital output is set. The inaccuracy of the pulse duration is less than 2 ms.

The pulse duration can be set to suit the actuators used. The pulse duration specifies how long the output is to be set for. The pulse duration can be preselected between 0 ms and 510 ms in increments of 2 ms.

If the pulse duration = 0, the output is set until the comparison condition is no longer fulfilled. Note that the count pulse times must be greater than the minimum switching times of the digital output.

Isochronous mode: In isochronous mode, as well, the DO1 output is switched as soon as the comparison condition is fulfilled and is therefore independent of the bus cycle. The status of the virtual output DO2 is signaled at time T_i .

Switch at Comparison Values

The comparator switches the output when the following conditions are met:

- The two comparison values must be loaded using the load functions CMP_VAL1 and CMP_VAL2, and
- After the comparison values are loaded, the DO1 output must be enabled with CRTL_DO1.

The following table shows you when the DO1 is switched on or off:

	DO1 is switched on when	DO1 is switched off when
V2 < V1 (see Figure below)	$V2 \leq \text{counter status} \leq V1$	$V2 > \text{counter status}$ or $\text{counter status} > V1$
V2 = V1	$V2 = \text{counter status} = V1$	$V2 \neq \text{counter status} \neq V1$
V2 > V1 (see Figure below)	$V1 > \text{counter status}$ or $\text{counter status} > V2$	$V1 \leq \text{counter status} \leq V2$

The comparison result is indicated by the status bit STS_CMP1. You can only acknowledge and thus reset this bit when the comparison condition is no longer fulfilled.

There is no hysteresis in the case of this output behavior.

It is not possible to control the DO1 output with the SET_DO1 control bit in the case of this output behavior.

Isochronous mode: In isochronous mode, as well, the DO1 output is switched as soon as the comparison condition is fulfilled and is therefore independent of the bus cycle. The status of the virtual output DO2 is signaled at time T_i .

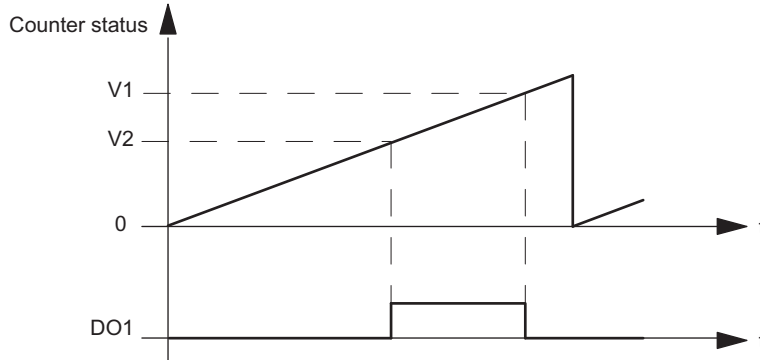

Figure 2-12 $V2 < V1$ at the Start of Counting

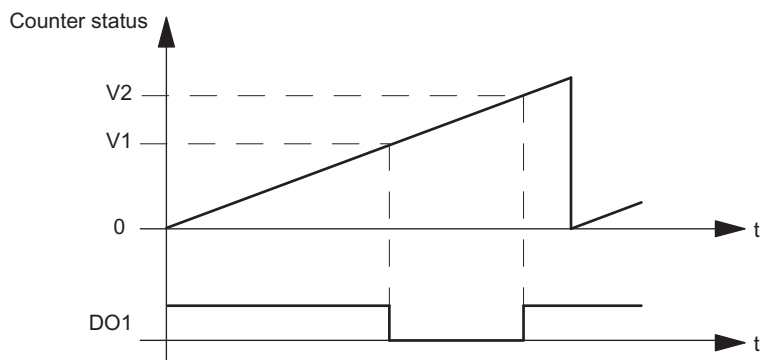

Figure 2-13 $V2 > V1$ at the Start of Counting

Setting or Modifying the Function and Behavior of the Digital Output DO1

When setting or modifying the behavior of DO1, you must take all assignable interdependencies into account. Failure to do so will generate a parameter assignment error or a loading error.

Boundary conditions:

If you assign "Switch at Comparison Values" for DO1, you must:

- Set hysteresis = 0, and
- Assign "Output" for the DO2 output

Hysteresis

An encoder can remain at a particular position and then fluctuate around this position. This state causes the counter status to fluctuate around a particular value. If there is a comparison value in this fluctuation range, for example, the associated output is switched on and off in accordance with the rhythm of the fluctuations. The 1Count24V is equipped with programmable hysteresis to prevent this switching in response to small fluctuations. You can assign a range between 0 and 255 (0 means: hysteresis switched off).

Hysteresis also works with overflow and underflow.

Method of Operation with Counter Status \leq Comparison Value and Counter Status \geq Comparison Value

The diagram below provides an example of how hysteresis works. The figure shows the differences in the behavior of an output when hysteresis of 0 (= switched off) is assigned as opposed to hysteresis of 3. In the example, the comparison value is 5.

The following settings are assigned for the counter: "Main count direction" = "Up" and "Switch on at counter status \geq comparison value".

When the comparison condition is met, hysteresis becomes active. While the hysteresis is active, the comparison result remains unchanged.

If the count value goes outside the hysteresis range, hysteresis is no longer active. The comparator switches again according to its comparison conditions.

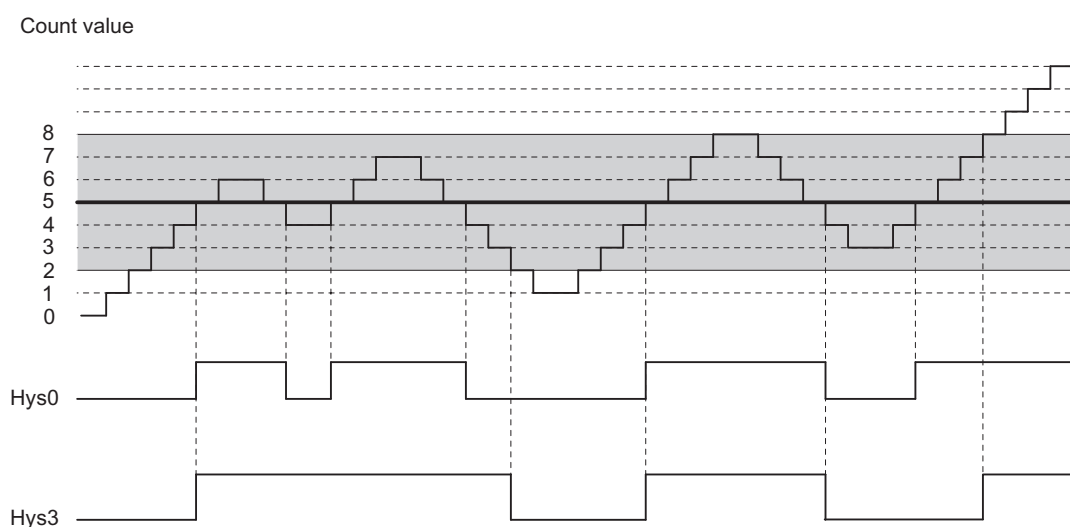

Figure 2-14 Example of How Hysteresis Works

Note

If the count direction changes on the comparison value when hysteresis is active, the output is reset.

Method of Operation when the Comparison Value Is Reached and the Pulse Duration = 0

The diagram below provides an example of how hysteresis works. The figure shows the various responses of an output with a hysteresis of 0 (= switched off) as opposed to hysteresis of 3. In the example, the comparison value is 5.

The following settings are assigned for the counter: "Pulse on reaching the comparison value", "No main count direction" and "Pulse duration = 0".

When the comparison conditions are met, hysteresis becomes active. While the hysteresis is active, the comparison result remains unchanged. If the count value goes outside the hysteresis range, hysteresis is no longer active. The comparator deletes the result of the comparison.

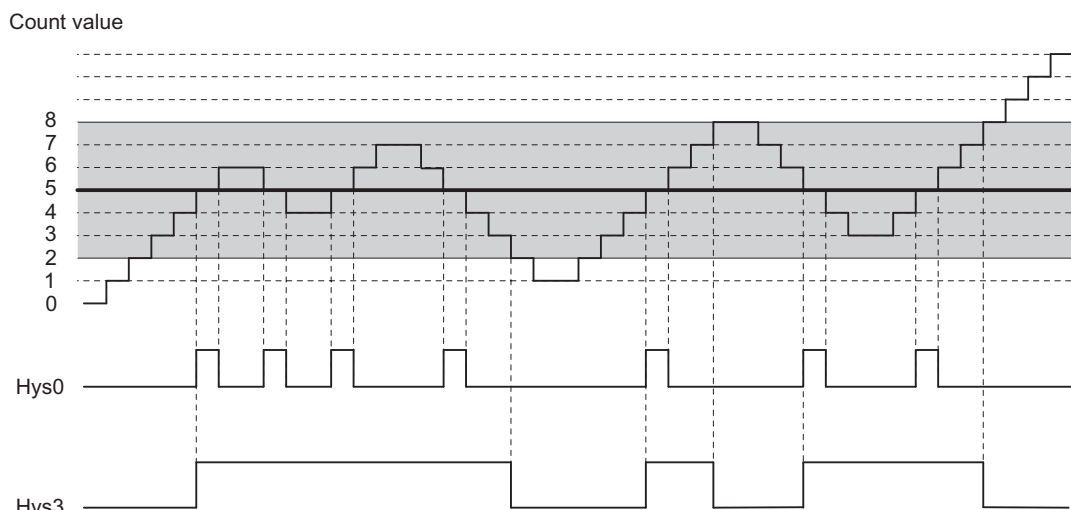

Figure 2-15 Example of How Hysteresis Works

Method of Operation when the Comparison Value Is Reached, Output Pulse Duration

The diagram below provides an example of how hysteresis works. The figure shows the various responses of an output with a hysteresis of 0 (= switched off) as opposed to hysteresis of 3. In the example, the comparison value is 5.

The following settings are assigned for the counter: "Pulse on reaching the comparison value", "No main count direction" and "pulse duration > 0".

When the comparison conditions have been met, hysteresis becomes active and a pulse of the assigned duration is output.

If the count value goes outside the hysteresis range, hysteresis is no longer active.

When hysteresis is enabled, the 1Count24V stores the count direction.

If the hysteresis range is exited in a different direction to the one stored, a pulse is output.

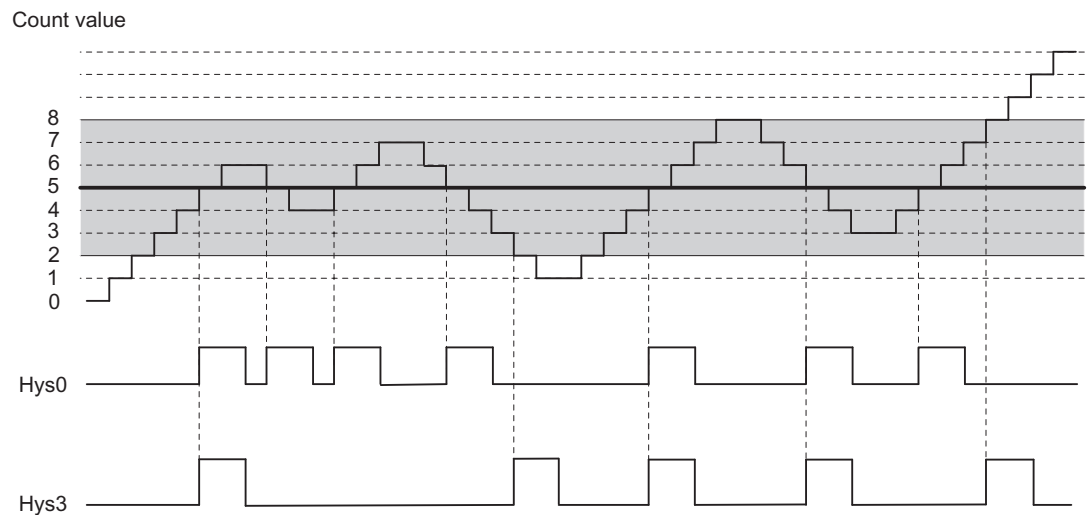

Figure 2-16 Example of How Hysteresis Works

Controlling the Outputs Simultaneously with the Comparators

If you have selected a comparison function for the outputs, you can continue to control the outputs with SET_DO1 or SET_DO2. This allows you to simulate the effect of the comparison functions on your control program:

- The output is set with the positive edge of SET_DO1 or SET_DO2.

However, if the Pulse on Reaching the Comparison Value function is selected, only one pulse with the specified duration is output. SET_DO1 and SET_DO2 have no effect when pulse duration = 0.

The SET_DO1 control bit is not permitted with the Switch at Comparison Values output behavior.

- A negative edge of SET_DO1 or SET_DO2 resets the output.

Note that the comparators are still active and can set or reset the output if the comparison result changes.

Note

An output set by SET_DO1 or SET_DO2 is not reset by the comparator.

Loading Comparison Values

You transfer the comparison values to the 1Count24V. The counting is not affected by this.

Valid Range for the Two Comparison Values

Main count direction: None	Main count direction: Up	Main count direction: Down
Low counting limit to high counting limit	-2147483648 to high counting limit -1	1 to 2147483647

Modifying the Function and Behavior of Digital Outputs

You can modify the functions and behavior of the outputs during operation using the control interface. The 1Count24V deletes the outputs and accepts the values as follows:

- Function of digital outputs DO1 and DO2: If you change this function so that the comparison condition is satisfied, the output is not set until after the next count pulse. However, if hysteresis is enabled, the 1Count24V does not make any changes at the output.
- Hysteresis: An active hysteresis (see How Hysteresis Works) continues to be active following the change. The new hysteresis range is applied the next time the comparison value is reached.
- Pulse duration: The new pulse duration takes effect with the next pulse.

2.6.10 Assignment of the Feedback and Control Interface for the Count Modes

Note

For the 1Count24V, the following data of the control and feedback interface are consistent:

Bytes 0 to 3

Bytes 4 to 7

Bytes 8 to 11 (modified user data interface)

Use the access or addressing mode for data consistency over the entire control and feedback interface on your master (only for configuration using the GSD file).

Assignment Tables

Table 2- 3 Feedback Interface (Inputs)

Address	Assignment	Designation
Bytes 0 to 3	Count value or stored count value in the case of the latch function on the digital input	
Byte 4	Bit 7: Short circuit of the encoder supply Bit 6: Short circuit / wire break / overtemperature Bit 5: Parameter assignment error Bit 4: Reserve = 0 Bit 3: Reserve = 0 Bit 2: Resetting of status bits active Bit 1: Load function error Bit 0: Load function is running	ERR_24V ERR_DO1 ERR_PARA RES_STS_A ERR_LOAD STS_LOAD
Byte 5	Bit 7: Down direction status Bit 6: Up direction status Bit 5: Reserve = 0 Bit 4: DO2 status Bit 3: DO1 status Bit 2: Reserve = 0 Bit 1: DI status Bit 0: Internal gate status	STS_C_DN STS_C_UP STS_DO2 STS_DO1 STS_DI STS_GATE
Byte 6	Bit 7: Zero-crossing in the count range when counting without a main count direction Bit 6: Low counting limit Bit 5: High counting limit Bit 4: Comparator 2 status Bit 3: Comparator 1 status Bit 2: Reserve = 0 Bit 1: Reserve = 0 Bit 0: Synchronization status	STS_ND STS_UFLW STS_OFLW STS_CMP2 STS_CMP1 STS_SYN
Byte 7	Reserve = 0	
Bytes 8 to 11	Count value ¹	

¹ Modified user data interface

Table 2- 4 Control Interface (Outputs)

Address		Assignment																																				
Bytes 0 to 3		Load value direct, preparatory, comparison value 1 or 2																																				
	Byte 0	Behavior of DO1, DO2 of the 1Count24V																																				
		<table border="1"> <thead> <tr> <th>Bit 2</th> <th>Bit 1</th> <th>Bit 0</th> <th>Function DO1</th> </tr> </thead> <tbody> <tr> <td>0</td> <td>0</td> <td>0</td> <td>Output</td> </tr> <tr> <td>0</td> <td>0</td> <td>1</td> <td>Switch on at counter status \geq comparison value</td> </tr> <tr> <td>0</td> <td>1</td> <td>0</td> <td>Switch on at counter status \leq comparison value</td> </tr> <tr> <td>0</td> <td>1</td> <td>1</td> <td>Pulse on reaching the comparison value</td> </tr> <tr> <td>1</td> <td>0</td> <td>0</td> <td>Switch at comparison values</td> </tr> <tr> <td>1</td> <td>0</td> <td>1</td> <td>blocked</td> </tr> <tr> <td>1</td> <td>1</td> <td>0</td> <td>blocked</td> </tr> <tr> <td>1</td> <td>1</td> <td>1</td> <td>blocked</td> </tr> </tbody> </table>	Bit 2	Bit 1	Bit 0	Function DO1	0	0	0	Output	0	0	1	Switch on at counter status \geq comparison value	0	1	0	Switch on at counter status \leq comparison value	0	1	1	Pulse on reaching the comparison value	1	0	0	Switch at comparison values	1	0	1	blocked	1	1	0	blocked	1	1	1	blocked
		Bit 2	Bit 1	Bit 0	Function DO1																																	
		0	0	0	Output																																	
0	0	1	Switch on at counter status \geq comparison value																																			
0	1	0	Switch on at counter status \leq comparison value																																			
0	1	1	Pulse on reaching the comparison value																																			
1	0	0	Switch at comparison values																																			
1	0	1	blocked																																			
1	1	0	blocked																																			
1	1	1	blocked																																			
<table border="1"> <thead> <tr> <th></th> <th>Bit 5</th> <th>Bit 4</th> <th>Function DO2</th> </tr> </thead> <tbody> <tr> <td></td> <td>0</td> <td>0</td> <td>Output</td> </tr> <tr> <td></td> <td>0</td> <td>1</td> <td>Switch on at counter status \geq comparison value</td> </tr> <tr> <td></td> <td>1</td> <td>0</td> <td>Switch on at counter status \leq comparison value</td> </tr> <tr> <td></td> <td>1</td> <td>1</td> <td>Pulse on reaching the comparison value</td> </tr> </tbody> </table>		Bit 5	Bit 4	Function DO2		0	0	Output		0	1	Switch on at counter status \geq comparison value		1	0	Switch on at counter status \leq comparison value		1	1	Pulse on reaching the comparison value																		
	Bit 5	Bit 4	Function DO2																																			
	0	0	Output																																			
	0	1	Switch on at counter status \geq comparison value																																			
	1	0	Switch on at counter status \leq comparison value																																			
	1	1	Pulse on reaching the comparison value																																			
Bits 3, 6, and 7: Reserve = 0																																						
	Bytes 1 to 3	Byte 1: Hysteresis DO1, DO2 (range 0 to 255) Byte 2: Pulse duration [2ms] DO1, DO2 (range 0 to 255) Byte 3: Reserve = 0																																				
Byte 4	EXTF_ACK CTRL_DO2 SET_DO2 CTRL_DO1 SET_DO1 RES_STS CTRL_SYN SW_GATE	Bit 7: Error diagnostics acknowledgment Bit 6: Enable DO2 Bit 5: Control bit DO2 Bit 4: Enable DO1 Bit 3: Control bit DO1 Bit 2: Start resetting of status bit Bit 1: Enable synchronization Bit 0: SW gate control bit																																				
Byte 5	C_DOPARAM CMP_VAL2 CMP_VAL1 LOAD_PREPARE LOAD_VAL	Bit 7: Reserve = 0 Bit 6: Reserve = 0 Bit 5: Reserve = 0 Bit 4: Change function and behavior of DO1, DO2 Bit 3: Load comparison value 2 Bit 2: Load comparison value 1 Bit 1: Load counter preparatory Bit 0: Load counter direct																																				
Bytes 6 to 7		Reserve = 0 ¹																																				
¹ Not used for modified user interface																																						

Notes on the Control Bits

Table 2- 5 Notes on the Control Bits

Control bits	Notes
C_DOPARAM	Change function and behavior of DO1, DO2 The values from bytes 0 to 2 are applied as new function, hysteresis, and pulse duration of DO1, DO2. This may result in the following error: The conditions for the "Switch at comparison values" behavior are not fulfilled.
CMP_VAL1	Load comparison value 1 The value from bytes 0 to 3 is transferred to comparison value 1 with the control bit "Load comparison value CMP_VAL1".
CMP_VAL2	Load comparison value 2 The value from bytes 0 to 3 is transferred to comparison value 2 with the control bit "Load comparison value CMP_VAL2".
CTRL_DO1	Enable DO1 You use this bit to enable the DO1 output.
CTRL_DO2	Enable DO2 You use this bit to enable the DO2 output.
CTRL_SYN	You use this bit to enable synchronization.
EXTF_ACK	Error acknowledgment The error bits must be acknowledged with the EXTF_ACK control bit after the cause is removed.
LOAD_PREPARE	Load counter preparatory The value from bytes 0 to 3 is applied as the load value.
LOAD_VAL	The value from bytes 0 to 3 is loaded directly as the new count value.
RES_STS	Start resetting of status bit The status bits are reset through the acknowledgment process between the RES_STS bit and the RES_STS_A bit.
SET_DO1	Control bit DO1 Switches the DO1 digital output on and off when CTRL_DO1 is set.
SET_DO2	Control bit DO2 Switches the DO2 digital output on and off when CTRL_DO2 is set.
SW_GATE	SW gate control bit The SW gate is opened/closed via the control interface with the SW_GATE bit.

Notes on the Feedback Bits

Table 2- 6 Notes on the Feedback Bits

Feedback bits	Notes
ERR_24V	Short circuit of the encoder supply The error bit must be acknowledged by the EXTF_ACK control bit Diagnostic message if assigned.
ERR_DO1	Short circuit/wire break/overtemperature due to overload at output DO1 The error bit must be acknowledged by the EXTF_ACK control bit Diagnostic message if assigned.
ERR_LOAD	Load function error The LOAD_VAL, LOAD_PREPARE, CMP_VAL1, CMP_VAL2, and C_DOPARAM bits cannot be set simultaneously during transfer. This results in setting the ERR_LOAD status bit, similar to loading an incorrect value (which is not accepted).
ERR_PARA	Parameter assignment error ERR_PARA
RES_STS_A	Resetting of status bits active
STS_C_DN	Down direction status
STS_C_UP	Up direction status
STS_CMP1	Comparator 1 status The STS_CMP1 status bit indicates that the output is or was switched on. It must be acknowledged with the RES_STS control bit. If the status bit is acknowledged when the output is still switched on, the bit is set again immediately. This bit is also set if the SET_DO1 control bit is used when DO1 is not enabled.
STS_CMP2	Comparator 2 status The STS_CMP2 status bit indicates that the output is or was switched on. It must be acknowledged with the RES_STS control bit. If the status bit is acknowledged when the output is still switched on, the bit is set again immediately. This bit is also set if the SET_DO2 control bit is used when DO2 is not enabled.
STS_DI	DI status The status of the DI is indicated in all modes with the STS_DI bit in the feedback interface.
STS_DO1	DO1 status The STS_DO1 status bit indicates the status of the DO1 digital output.
STS_DO2	DO2 status The STS_DO2 status bit indicates the status of the virtual DO2 digital output.
STS_GATE	Internal gate status: Counting
STS_LOAD	Load function is running
STS_ND	Zero-crossing in the count range when counting without a main counting direction. The bit must be reset by the RES_STS control bit.
STS_OFLW STS_UFLW	High counting limit violated Low counting limit violated Both bits must be reset.
STS_SYN	Synchronization status After successful synchronization, the STS_SYN bit is set. It must be reset by the RES_STS control bit.

Access to the Control and Feedback Interface in STEP 7 Programming

Table 2-7 Access to the Control and Feedback Interface in STEP 7 Programming

	Configuring with STEP 7 using the GSD file ¹⁾ (Hardware catalog\PROFIBUS-DP\Additional FIELD DEVICES\I/O\ET 200S)	Configuring with STEP 7 using HW Config (Hardware catalog\PROFIBUS-DP\ET 200S)
Feedback interface	Read with SFC 14 "DPRD_DAT"	Load command (e.g. L PID)
Control interface	Write with SFC 15 "DPWR_DAT"	Transfer command (e.g. T PQD)
¹ Load and transfer commands are also possible with CPU 3xxC, CPU 3xx with MMC, CPU 4xx (V3.0 and later), and WinLC RTX (PC CPU).		

Resetting of the Status Bits

STS_SYN, STS_CMP1, STS_CMP2, STS_OFLW, STS_UFLW, STS_ND

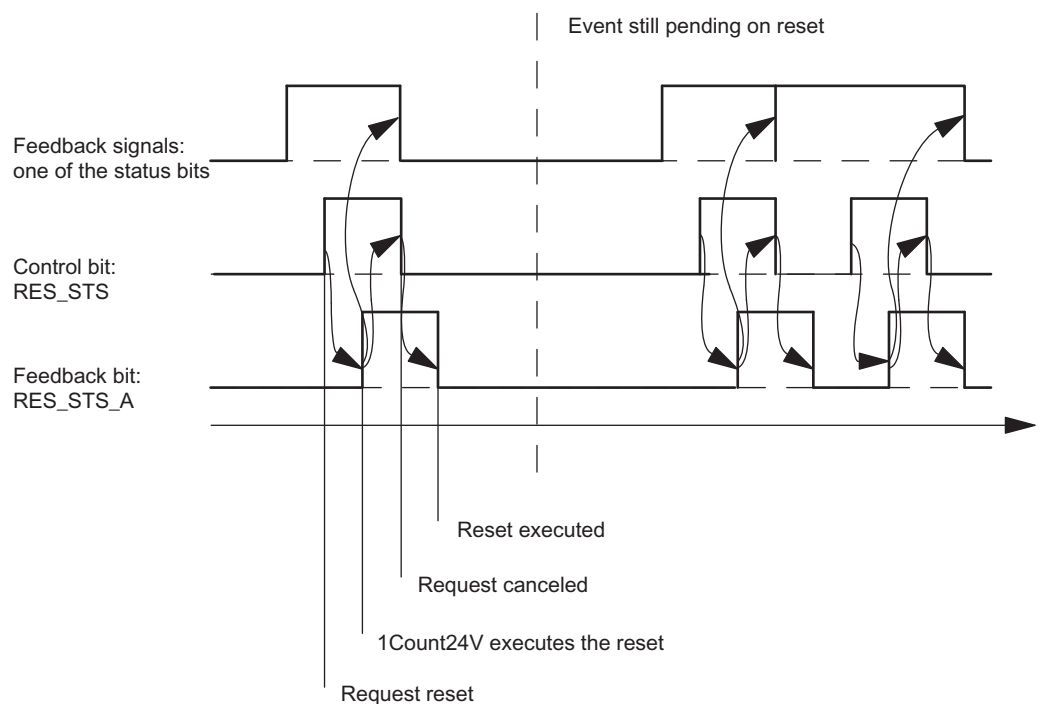

Figure 2-17 Resetting of the Status Bits

Acceptance of Values with the Load Function

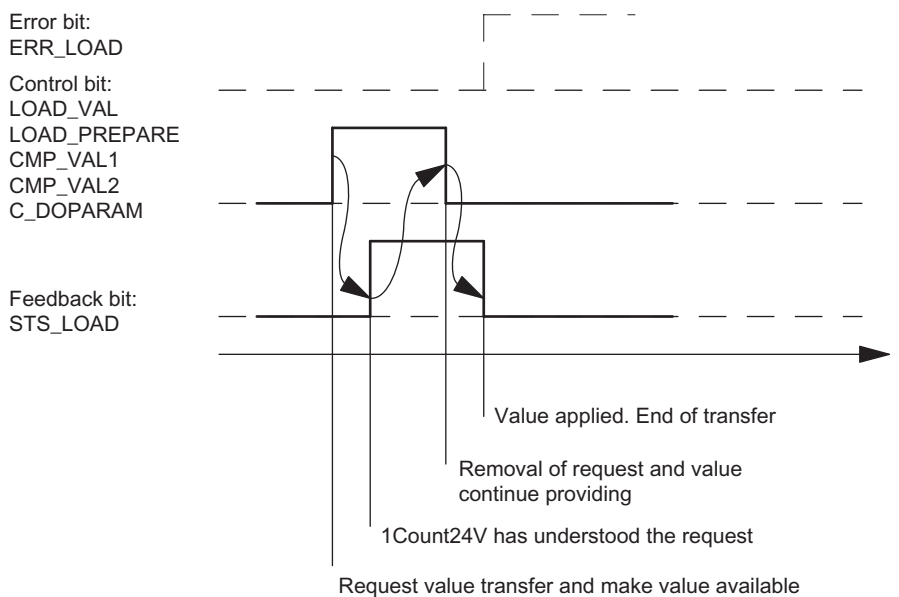

Figure 2-18 Acceptance of Values with the Load Function

Note

Only one of the following control bits can be set at a particular time:

CMP_VAL1 or CMP_VAL2 or LOAD_VAL or LOAD_PREPARE or C_DOPARAM.

Otherwise, the ERR_LOAD error is reported until all the specified control bits are deleted again.

The ERR_LOAD error bit is only deleted when the following is carried out correctly.

Acknowledgment Principle in Isochronous Mode

In isochronous mode, exactly 4 bus cycles are always required to reset the status bits and to accept values during the load function.

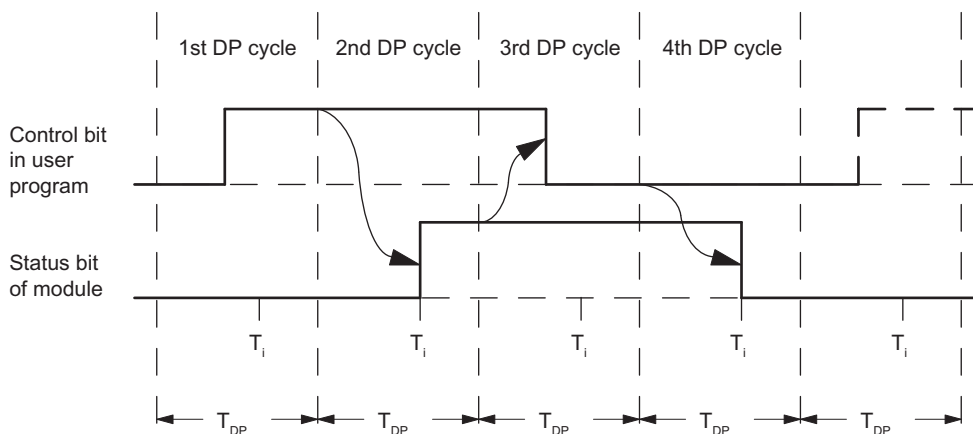

Figure 2-19 Acknowledgment Principle in Isochronous Mode

Error Detection

The program errors must be acknowledged. They have been detected by the 1Count24V and are indicated at the feedback interface. Channel-specific diagnostics are performed if you have enabled group diagnostics in your configuration (see device manual of the interface module used).

The parameter assignment error bit is acknowledged by means of correct parameter assignment.

An error has occurred, the 1Count24V sets an error bit, a diagnostic message may appear, error detection continues

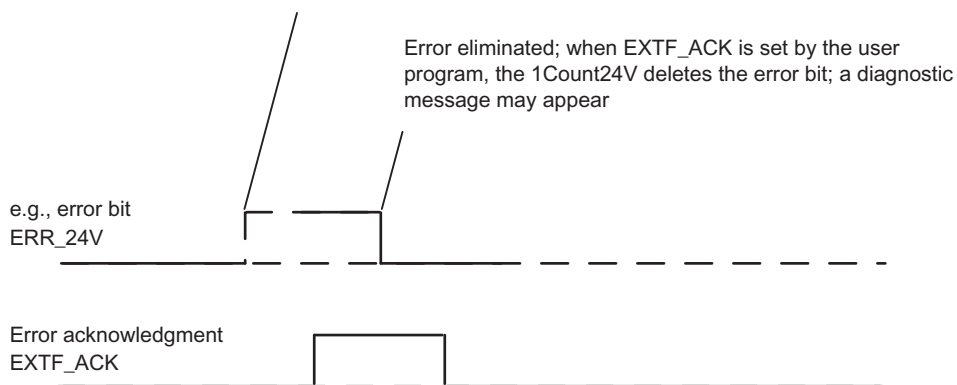

Figure 2-20 Error Acknowledgment

In the case of continuous error acknowledgment (EXT_F_ACK=1) or at CPU/Master Stop, the 1Count24V signals errors as soon as they are detected and resets them as soon as they have been eliminated.

2.6.11 Parameter Assignment for the Count Modes

Introduction

You can use either of the following to assign parameters for the 1Count24V:

- STEP 7 V5.3 SP2 or later
- A GSD file (<http://www.automation.siemens.com/csi/gsd>)

Parameter List for Counting Modes

Table 2- 8 Parameter List for Counting Modes

Parameters	Value range	Default
Enable		
Group diagnostics	Disable/enable	Disable
Response to failure of the higher-level controller		
Response to CPU/master STOP	Turn off DO1/ Continue working mode/ DO1 substitute a value/ DO1 keep last value	Turn off DO1
Encoder parameters		
Signal evaluation A, B	Pulse and direction/ Rotary encoder single/ double/ quadruple	Pulse and direction
Encoder and input filter • At count input (track A) • At direction input (track B) • At digital input DI	• 2.5 µs/25 µs • 2.5 µs/25 µs • 2.5 µs/25 µs	• 2.5 µs • 2.5 µs • 2.5 µs
Sensor A, B, DI	24V P switch, normal mode/ 24V M switch	24V P switch, normal mode
Direction input B	Normal/Inverted	Normal
Output parameters		
Function DO1	Output/ Switch on at counter status ≥ comparison value/ Switch on at counter status ≤ comparison value/ Pulse on reaching the comparison value/ Switch at comparison values	Output
Function DO2	Output/ Switch on at counter status ≥ comparison value/ Switch on at counter status ≤ comparison value/ Pulse on reaching the comparison value	Output
Substitute value DO1	0/1	0
Diagnostics DO1 ¹	Off/on	Off
Hysteresis DO1, DO2	0...255	0
Pulse duration [2 ms] DO1, DO2	0...255	0

Parameters	Value range	Default
Mode		
Counting mode	Continuous counting/ Once-only counting/ Periodic counting	Count continuously
Gate function	Cancel counting/ Interrupt counting	Cancel counting
Input signal HW gate	Normal/Inverted	Normal
Function DI	Input / HW gate / Latch and retrigger at positive edge / Synchronization at positive edge / Latch at positive edge	Input
Synchronization ²	Once-only/Periodically	Once-only
Main count direction	None/Up/Down	None
High counting limit	2 ... 7FFF FFFF	7FFF FFFF
¹ DO1 diagnostics (wire break, short circuit) is possible only with pulse lengths of > 90 ms on digital output DO1. ² Only relevant if Function DI = Synchronization at positive edge		

Parameter Assignment Error

- Incorrect mode
- Incorrect main count direction
- The "Input signal HW gate" parameter is set to inverted and the "Function DI" parameter is not set to HW gate.
- High counting limit incorrect
- The value for the behavior of DO2 is not set to output although "Switch at comparison values" has been assigned for DO1.
- The value for hysteresis does not equal 0 although "Switch at comparison values" has been assigned for DO1.

What to Do in the Event of Errors

Check the set value ranges.

2.7 Measurement Modes

2.7.1 Overview

Introduction

For the "Measuring Mode" parameter, you can select from the following modes:

- Frequency measurement
- Period measurement
- Rotational speed measurement

For the "Measuring Method" parameter, you can select from the measurement methods:

- With integration time
- Continuous

To run one of these modes, you have to assign parameters to the 1Count24V.

(see section "Parameter Assignment for Measurement Modes (Page 82)")

Sequence of Measurements with Integration Time

The measurement is carried out during the assigned integration time. When the integration time elapses, the measured value is updated.

The end of a measurement is indicated by the STS_CMP1 status bit. This bit is reset by the RES_STS control bit in the control interface.

If there were not at least two rising edges in the assigned integration time, 0 is returned as the measured value.

A value of -1 is returned up until the end of the first integration time.

You can change the integration time for the next measurement during operation.

Direction Reversal

If the direction of rotation is reversed during an integration time, the measured value for this measurement period is uncertain. If you evaluate the STS_C_UP and STS_C_DN feedback bits (direction evaluation), you can respond to any process irregularities.

2.7.2 Sequence of continuous-action measurement

Measuring Principle

The 1Count24V counts each positive edge of a pulse and assigns it a time value in μs .

The update time indicates the time interval at which the measured value is updated by the module in the feedback interface.

Rule for pulse sequences with one or several pulses per update time:

Dynamic measuring time = Time of last pulse in the current update time interval
minus
Time of last pulse in the previous update time interval

When the update time has elapsed, a new measured value is calculated and output with the dynamic measuring time.

If the current update time does not contain a pulse, the following dynamic measuring time results:

Dynamic measuring time = Time of current, elapsed update time
minus
Time of last pulse

When the update time has elapsed, an estimated measured value is calculated with the dynamic measuring time under the assumption that a pulse occurred at the end of the update time.

If the "1 Pulse per dynamic measuring time" estimated measured value is less than the last measured value during the frequency and speed measurement, this estimated measured value is output as the new measured value. With the period measurement, the dynamic measuring time is output as the estimated period if the dynamic measuring time is greater than the last measured period.

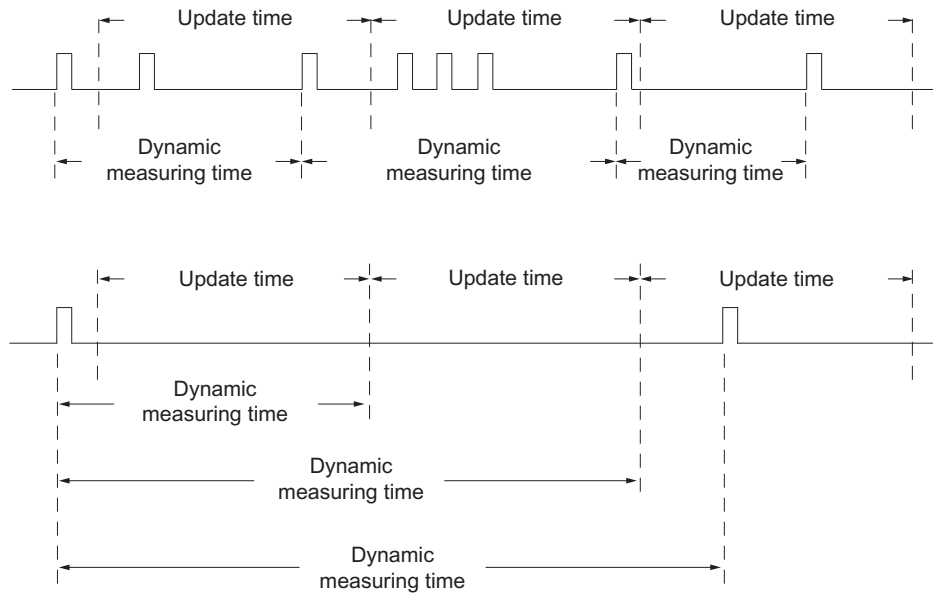

Figure 2-21 Measuring Principle

The 1Count24V measures continuously. When assigning parameters, you specify an update time.

During the time until the end of the first elapsed update time, a value of "-1" is returned.

The continuous measurement begins after the gate is opened with the first pulse of the pulse train to be measured. The first measured value can be calculated after the second pulse, at the earliest.

A measured value (frequency, period, or speed) is output in the feedback interface each time the update time elapses. The end of a measurement is indicated with the STS_CMP1 status bits. This bit is reset with the RES_STS and RES_STS_A bits according to the complete acknowledgement principle.

If the direction of rotation is reversed during an update time, the measured value for this measurement period is undefined. By evaluating the STS_C_DN and STS_C_UP feedback bits (direction evaluation), you can respond to any process irregularities.

The following figure illustrates the principle of continuous measurement using frequency measurement as an example.

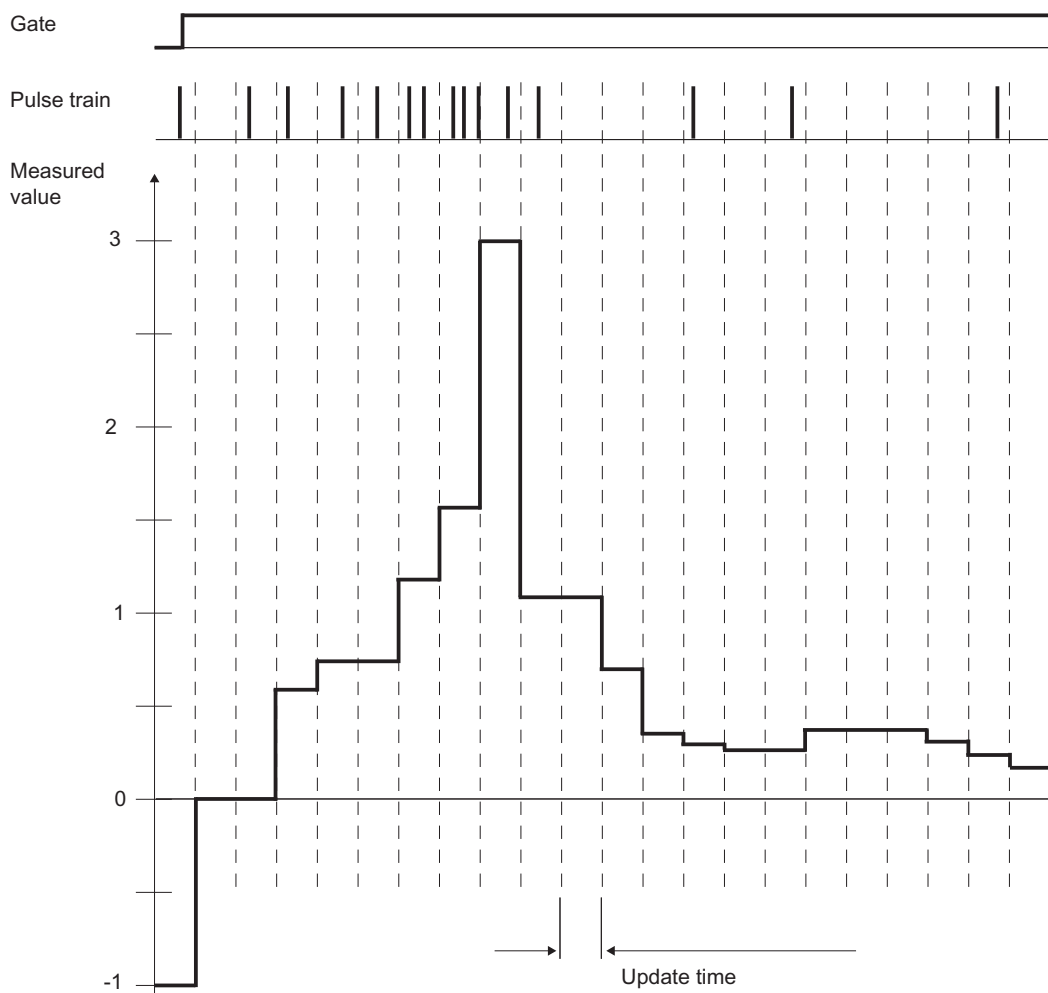

Figure 2-22 Principle of Continuous Measurement (Frequency Measurement Example)

Gate Control

To control the 1Count24V, you have to use the gate functions.

Isochronous Mode

In isochronous mode, the 1Count24V accepts control bits and control values from the control interface in each bus cycle and reports back the response in the same cycle.

In each cycle, the 1Count24V transfers a measured value and the status bits that were valid at time T_i .

The measurement starts and ends at time T_i .

Integration Time and Update Time in Isochronous Mode

If the integration time/update time lasts several T_{DP} cycles, you can recognize the new measured value in the user program at the bit STS_CMP1 status bit (measurement completed) of the feedback interface. This enables monitoring of the measuring operation or a synchronization with the measuring operation. It takes 4 T_{DP} cycles, however, for this message to be acknowledged. The minimum integration time/update time in this case is $(4 \times T_{DP})$.

If the application can tolerate a jitter in the integration time/update time of T_{DP} and a measured value that remains constant for several cycles, you do not need to continually evaluate status bit STS_CMP1. Integration times/update times of $(1 \times T_{DP})$ to $(3 \times T_{DP})$ are then possible.

Because isochronous operation was lost in the last T_{DP} cycle of the integration time, the integration time/update time is increased by one T_{DP} cycle. This does not corrupt the measured value.

Note

The value range limits for the integration time/update time must not be exceeded (see tables for the individual measuring modes).

A violation of the value range limits will result in a parameter assignment error, and the 1Count24V will not go into isochronous mode.

Note

When you change the configuration from non-isochronous to isochronous mode and vice versa, you must always adjust the integration time/update time parameter if you want to keep the length of the integration time/update time.

2.7.3 Frequency measurement with integration time

Definition

In frequency measurement mode, the 1Count24V counts the pulses that arrive within a set integration time.

Integration time

You preset the integration time with the integration time parameter (see table).

Table 2-9 Calculation of the Integration Time

Boundary Conditions		Integration time	Range of n	
			n _{min}	n _{max}
Non-isochronous mode	Any T _{DP}	n x 10 ms	1	1000
Isochronous Mode	T _{DP} < 10 ms	n x T _{DP}	(10 ms/T _{DP} [ms]) + 1 ¹	1000
	T _{DP} ≥ 10 ms	n x T _{DP}	1	10000 ms/T _{DP} [ms] ¹

¹ Any digits after the decimal point that come about after dividing by T_{DP} are omitted. It is not permitted to violate these limits. If these limits are violated, the 1Count24V generates a parameter assignment error and will not go into isochronous mode.

Frequency Measurement

The value of the calculated frequency is made available in the unit 10⁻³ Hz. The measured frequency value can be read in the feedback interface (byte 0 to 3).

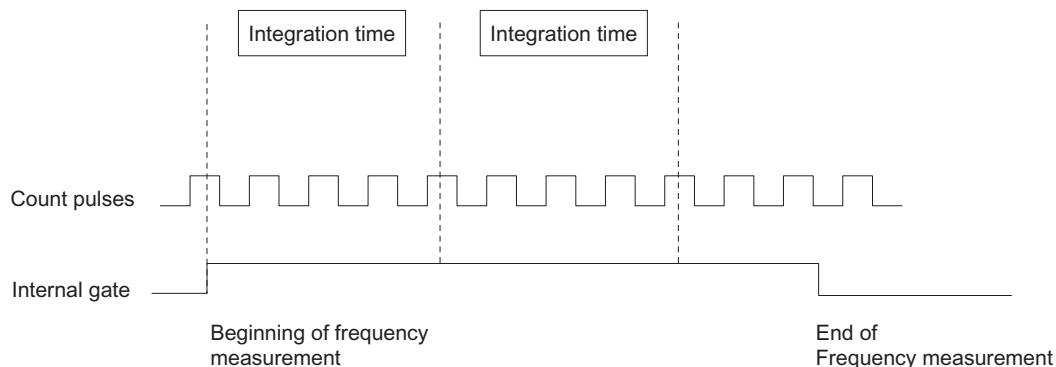

Figure 2-23 Frequency Measurement with Gate Function

Limit-Value Monitoring

The following value ranges are permitted for limit-value monitoring:

Low limit f_u	High limit f_o
0 to $99,999,999 \times 10^{-3}$ Hz	f_u+1 to $100,000,000 \times 10^{-3}$ Hz

Possible Measuring Ranges with Error Indication

Integration time	$f_{min} \pm$ absolute error	$f_{max} \pm$ absolute error
10 s	0.1 Hz \pm 0.001 Hz	100 000 Hz \pm 18 Hz
1 s	1 Hz \pm 0.001 Hz	100 000 Hz \pm 11 Hz
0.1 s	10 Hz \pm 0.002 Hz	100 000 Hz \pm 10 Hz
0.01 s	100 Hz \pm 0.013 Hz	100 000 Hz \pm 13 Hz

2.7.4 Continuous Frequency Measurement

Definition

In frequency measurement mode, the 1Count24V counts the pulses that arrive within a dynamic measuring period.

Update Time

The 1Count24V updates the measured values cyclically. You preset the update time with the Update Time parameter (see table). You can change the update time during operation.

Table 2- 10 Calculation of the Update Time

Boundary conditions		Update time	Range of n	
			n _{min}	n _{max}
Non-isochronous mode	Any T _{DP}	n x 10 ms	1	1000
Isochronous mode	T _{DP} < 10 ms	n x T _{DP}	(10 ms/T _{DP} [ms]) + 1 ¹	1000
	T _{DP} ≥ 10 ms	n x T _{DP}	1	10000 ms/T _{DP} [ms] ¹

¹ Any digits after the decimal point resulting from division by T_{DP} are omitted. These limits may not be violated. If these limits are violated, the 1Count24V generates a parameter assignment error and will not go into isochronous mode.

Frequency measurement

The value of the calculated frequency is made available in the unit 10⁻³ Hz. The measured frequency value can be read in the feedback interface (byte 0 to 3).

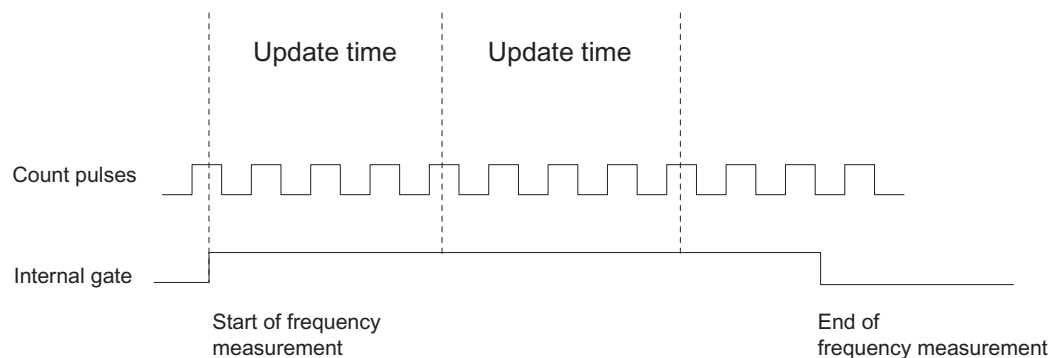

Figure 2-24 Frequency Measurement with Gate Function

Limit-Value Monitoring

The following value ranges are permitted for limit-value monitoring:

Encoder type	Low limit f_u	High limit f_o
24-V encoders	0 to $99,999,999 \times 10^{-3}$ Hz	f_u+1 to $100,000,000 \times 10^{-3}$ Hz

Possible Measuring Ranges with Error Indication

Frequency f	Absolute error
0.1 Hz	± 0.001 Hz
1 Hz	± 0.001 Hz
10 Hz	± 0.003 Hz
100 Hz	± 0.02 Hz
1 000 Hz	± 0.18 Hz
10 000 Hz	± 1.8 Hz
100 000 Hz	± 18 Hz

Function of the Digital Input

For the "Function DI" parameter, select one of the following functions for the digital input:

- Input
- HW gate (see section "Gate Functions in Measurement Modes (Page 72)")

Function of the Digital Output DO1

For the "Function DO1" parameter, select one of the following functions for the DO1 digital output:

- Output (no switching by the limit-value monitoring)
- Measured value outside the limits
- Measured value under the low limit
- Measured value over the high limit

(see section "Behavior of the Output in Measurement Modes (Page 73)")

Changing Values during Operation

The following values can be changed during operation:

- Low limit (LOAD_PREPARE)
- High limit (LOAD_VAL)
- Function of the Digital Output DO1 (C_DOPARAM)
- Integration time/update time (C_INTTIME)

(see section "Assignment of the Feedback and Control Interfaces for the Measurement Modes (Page 75)")

2.7.5 Rotational speed measurement with integration time

Definition

In rotational speed measurement mode, the 1Count24V counts the pulses that arrive from a tachometer generator within a set integration time and calculates the speed of the connected motor.

Integration Time

You preset the integration time with the Integration Time parameter (see table).

Table 2- 11 Calculation of the Integration Time

Boundary conditions		Integration time	Range of n	
			n _{min}	n _{max}
Non-isochronous mode	Any T _{DP}	n x 10 ms	1	1000
Isochronous mode	T _{DP} < 10 ms	n x T _{DP}	(10 ms/T _{DP} [ms]) + 1 ¹	1000
	T _{DP} ≥ 10 ms	n x T _{DP}	1	10000 ms/T _{DP} [ms] ¹

¹ Any digits after the decimal point that come about after dividing by T_{DP} are omitted. These limits must not be violated. If these limits are violated, the 1Count24V generates a parameter assignment error and will not go into isochronous mode.

Rotational Speed Measurement

For rotational speed measurement mode, you also have to assign the pulses per encoder or motor revolution.

The rotational speed is returned in the unit 1×10^{-3} /min.

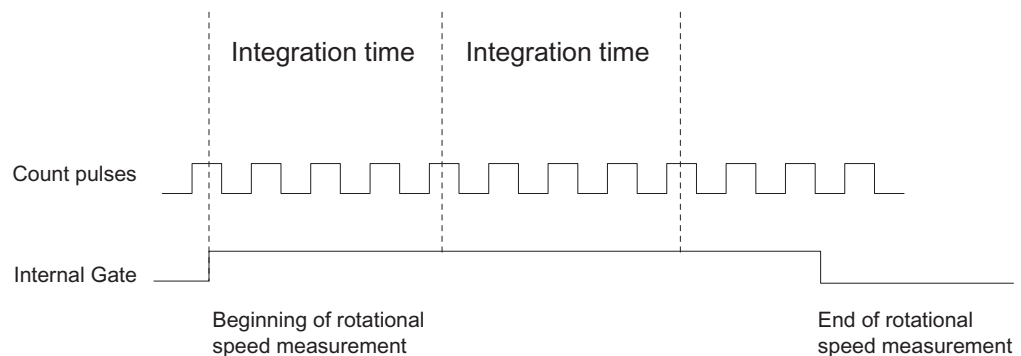

Figure 2-25 Rotational Speed Measurement with Gate Function

Limit-Value Monitoring

The following value ranges are permitted for limit-value monitoring:

Low limit n_u	High limit n_o
0 to 24 999 999 $\times 10^{-3}$ /min	n_u+1 to 25 000 000 $\times 10^{-3}$ /min

Possible Measuring Ranges with Error Indication

Table 2- 12 Possible Measuring Ranges with Error Indication (Number of Pulses per Encoder Revolution = 60)

Integration time	$n_{min} \pm \text{absolute error}$	$n_{max} \pm \text{absolute error}$
10 s	1 /min \pm 0.03 /min	25000 /min \pm 4.5 /min
1 s	1 /min \pm 0.03 /min	25000 /min \pm 2.8 /min
0.1 s	10 /min \pm 0.03 /min	25000 /min \pm 2.6 /min
0.01 s	100 /min \pm 0.04 /min	25000 /min \pm 3.2 /min

2.7.6 Continuous Rotational Speed Measurement

Definition

In rotational speed measurement mode, the 1Count24V counts the pulses that are received from a tachometer generator within a dynamic measuring time, and calculates the speed from this value with the number of pulses per encoder revolution.

Update time

The 1Count24V updates the measured values cyclically. You preset the update time with the Update Time parameter (see table). You can change the update time during operation.

Table 2- 13 Calculation of the Update Time

Boundary conditions		Update time	Range of n	
			n_{\min}	n_{\max}
Non-isochronous mode	Any T_{DP}	$n \times 10 \text{ ms}$	1	1000
Isochronous mode	$T_{DP} < 10 \text{ ms}$	$n \times T_{DP}$	$(10 \text{ ms}/T_{DP} [\text{ms}]) + 1$ ¹	1000
	$T_{DP} \geq 10 \text{ ms}$	$n \times T_{DP}$	1	$10000 \text{ ms}/T_{DP} [\text{ms}]$ ¹

¹ Any digits after the decimal point resulting from division by T_{DP} are omitted. These limits may not be violated. If these limits are violated, the 1Count24V generates a parameter assignment error and will not go into isochronous mode.

Rotational Speed Measurement

For the rotational speed measurement mode, you must also assign the pulses per encoder revolution.

The rotational speed is returned in the unit $1 \times 10^{-3} / \text{min}$.

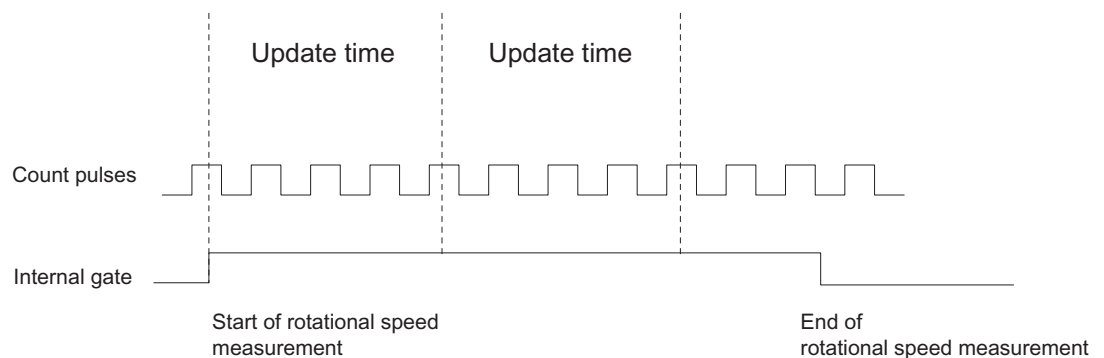

Figure 2-26 Rotational Speed Measurement with Gate Function

Limit-Value Monitoring

The following value ranges are permitted for limit-value monitoring:

Low limit n_u	High limit n_o
0 to 24 999 999 $\times 10^{-3}$ /min	n_u+1 to 25 000 000 $\times 10^{-3}$ /min

Possible Measuring Ranges with Error Indication

Table 2- 14 Possible Measuring Ranges with Error Indication (Number of Pulses per Encoder Revolution = 60)

Rotational speed n	Absolute error
1 /min	± 0.04 /min
10 /min	± 0.04 /min
100 /min	± 0.05 /min
1 000 /min	± 0.21 /min
10 000 /min	± 1.82 /min
25 000 /min	± 4.50 /min

Function of the Digital Input

For the "Function DI" parameter, select one of the following functions for the digital input:

- Input
- HW gate (see section "Gate Functions in Measurement Modes (Page 72)")

Function of the Digital Output DO1

For the "Function DO1" parameter, select one of the following functions for the DO1 digital output:

- Output (no switching by the limit-value monitoring)
- Measured value outside the limits
- Measured value under the low limit
- Measured value over the high limit

(see section "Behavior of the Output in Measurement Modes (Page 73)")

Values that Can Be Changed During Operation

- Low limit (LOAD_PREPARE)
- High limit (LOAD_VAL)
- Function of the digital output DO1 (C_DOPARAM)
- Integration time/update time (C_INTTIME)

(see section "Assignment of the Feedback and Control Interfaces for the Measurement Modes (Page 75)")

2.7.7 Period measurement with integration time

Definition

In period measurement mode, the 1Count24V measures the time between two positive edges of the counting signal by counting the pulses of an internal quartz-accurate reference frequency (16 MHz) within a preset integration time.

Integration Time

You preset the integration time with the Integration Time parameter (see table).

Table 2- 15 Calculation of the Integration Time

Boundary conditions		Integration time	Range of n	
			n _{min}	n _{max}
Non-isochronous mode	Any T _{DP}	n x 10 ms	1	12000
Isochronous mode	T _{DP} < 10 ms	n x T _{DP}	10 ms/T _{DP} [ms] + 1 ¹	12000
	T _{DP} ≥ 10 ms	n x T _{DP}	1	120000 ms/T _{DP} [ms] ¹

¹ Any digits after the decimal point resulting from division by T_{DP} are omitted. These limits may not be violated. If these limits are violated, the 1Count24V generates a parameter assignment error and will not go into isochronous mode.

Period measurement

The value of the calculated period is given in the unit 1 μs or 1/16 μs. The measured period can be read in the feedback interface (byte 0 to 3).

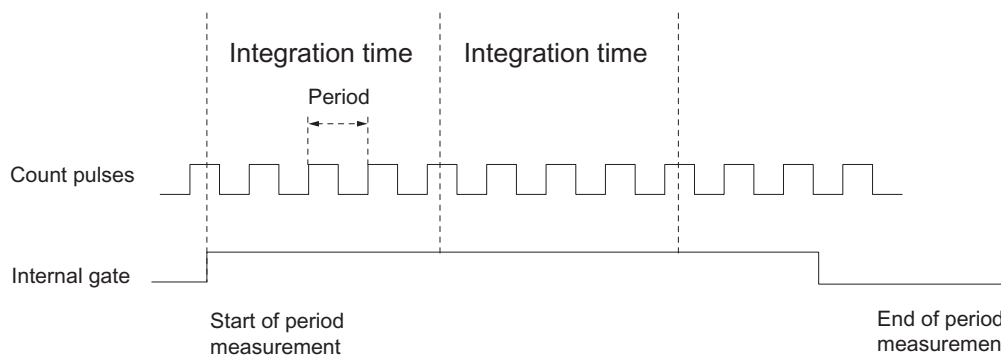

Figure 2-27 Period Measurement with Gate Function

Limit-Value Monitoring

The following value ranges are permitted for limit-value monitoring:

1 μs resolution

Low limit T_u	High limit T_o
0 to 119 999 999 μs	T_u+1 to 120 000 000 μs

1/16 μs resolution

Low limit T_u	High limit T_o
0 to 1 919 999 999 μs	T_u+1 to 1 920 000 000 μs

Possible Measuring Ranges with Error Indication

1 μs resolution

Integration time	$T_{\min} \pm \text{absolute error}$	$T \pm \text{absolute error}$
100 s	1 μs^* (10 \pm 0)	1 μs^* (100 000 000 \pm 10 000)
10 s	1 μs^* (10 \pm 0)	1 μs^* (10 000 000 \pm 1 000)
1 s	1 μs^* (10 \pm 0)	1 μs^* (1 000 000 \pm 100)
0.1 s	1 μs^* (10 \pm 0)	1 μs^* (100 000 \pm 10)
0.01 s	1 μs^* (10 \pm 0)	1 μs^* (10 000 \pm 1)

1/16 μs resolution

Integration time	$T_{\min} \pm \text{absolute error}$	$T \pm \text{absolute error}$
100 s	1/16 μs^* (160 \pm 0)	1/16 μs^* (1 600 000 000 \pm 160 000)
10 s	1/16 μs^* (160 \pm 0)	1/16 μs^* (160 000 000 \pm 16 000)
1 s	1/16 μs^* (160 \pm 0)	1/16 μs^* (16 000 000 \pm 1 600)
0.1 s	1/16 μs^* (160 \pm 0)	1/16 μs^* (1 600 000 \pm 160)
0.01 s	1/16 μs^* (160 \pm 0)	1/16 μs^* (160 000 \pm 16)

2.7.8 Continuous Period Measurement

Definition

In period measurement mode, the 1Count24V indicates the dynamic measuring time as a period. If the period is less than the update time, then an average is calculated for the period.

Update Time

The 1Count24V updates the measured values cyclically. You preset the update time with the Update Time parameter (see table). You can change the update time during operation.

Table 2- 16 Calculation of the Update Time

Boundary conditions		Update time	Range of n	
			n _{min}	n _{max}
Non-isochronous mode	Any T _{DP}	n x 10 ms	1	12000
Isochronous mode	T _{DP} < 10 ms	n x T _{DP}	10 ms/T _{DP} [ms] + 1 ¹	12000
	T _{DP} ≥ 10 ms	n x T _{DP}	1	120000 ms/T _{DP} [ms] ¹

¹ Any digits after the decimal point resulting from division by T_{DP} are omitted. These limits may not be violated. If these limits are violated, the 1Count24V generates a parameter assignment error and will not go into isochronous mode.

Period measurement

The value of the calculated period is given in the unit 1 μs or 1/16 μs. The measured period can be read in the feedback interface (byte 0 to 3).

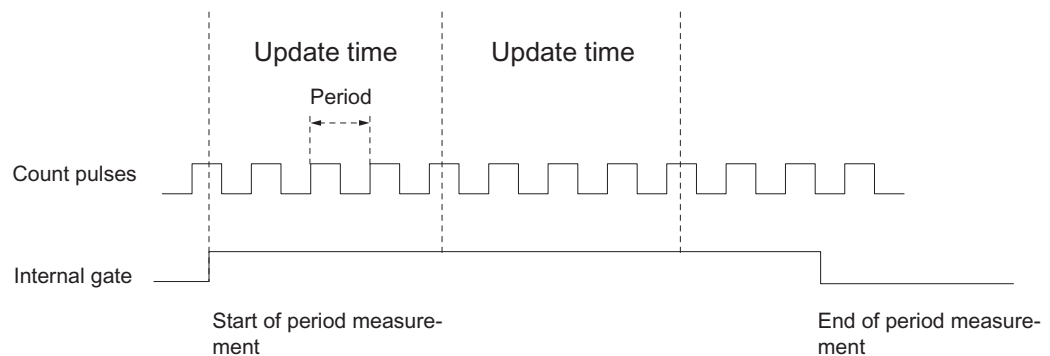

Figure 2-28 Period Measurement with Gate Function

Limit-Value Monitoring

The following value ranges are permitted for limit-value monitoring:

1 µs resolution

Low limit T _u	High limit T _o
0 to 119 999 999 µs	T _u +1 to 120 000 000 µs

1/16 µs resolution

Low limit T _u	High limit T _o
0 to 1 919 999 999 µs	T _u +1 to 1 920 000 000 µs

Possible Measuring Ranges with Error Indication

1 µs resolution

Period T _{min} ± Absolute error	Period T _{min} ± Absolute error
1 µs* (10 ± 0)	1 µs* (100 000 ± 10)
1 µs* (100 ± 0)	1 µs* (1 000 000 ± 100)
1 µs* (1 000 ± 0)	1 µs* (10 000 000 ± 1 002)
1 µs* (10 000 ± 0)	1 µs* (100 000 000 ± 10 020)

1/16 µs resolution

Period T _{min} ± Absolute error	Period T _{min} ± Absolute error
1/16 µs* (160 ± 1)	1/16 µs* (1 600 000 ± 160)
1/16 µs* (1 600 ± 1)	1/16 µs* (16 000 000 ± 1 600)
1/16 µs* (16 000 ± 3)	1/16 µs* (160 000 000 ± 16 000)
1/16 µs* (160 000 ± 20)	1/16 µs* (1 600 000 000 ± 160 000)

Function of the Digital Input

For the "Function DI" parameter, select one of the following functions for the digital input:

- Input
- HW gate (see section "Gate Functions in Measurement Modes (Page 72)")

Function of the Digital Output DO1

For the "Function DO1" parameter, select one of the following functions for the digital output:

- Output (no switching by the limit-value monitoring)
- Measured value outside the limits
- Measured value under the low limit
- Measured value over the high limit

(see section "Behavior of the Output in Measurement Modes (Page 73)")

Values that Can Be Changed During Operation

- Low limit (LOAD_PREPARE)
- High limit (LOAD_VAL)
- Function of the Digital Output DO1 (C_DOPARAM)
- Integration time/update time (C_INTTIME)

(see section "Assignment of the Feedback and Control Interfaces for the Measurement Modes (Page 75)")

2.7.9 Gate Functions in Measurement Modes

Software Gate and Hardware Gate

The 1Count24V has two gates

- A software gate (SW gate), which is controlled by the SW_GATE control bit.
The software gate can only be opened by a positive edge of the SW_GATE control bit. It is closed when this bit is reset. Note the transfer times and run times of your control program.
- A hardware gate (HW gate), which is controlled by means of the digital input on the 1Count24V. You assign the hardware gate as the function of the digital input (Function DI "HW Gate"). It is opened on a positive edge at the digital input and closed on a negative edge.

Internal gate

The internal gate is the logical AND operation of the HW gate and SW gate. Counting is only active when the HW gate and the SW gate are open. The STS_GATE feedback bit (internal gate status) indicates this. If a HW gate has not been assigned, the setting of the SW gate is decisive.

Gate Control

Gate control by means of the SW gate only

The opening/closing of the SW gate starts/stops measurement.

If the SW gate is opened in isochronous mode in bus cycle "n" by setting the SW_GATE control bit, measurement starts at time T_i in cycle "n+1".

Gate control by SW gate and HW gate

The opening and closing of the SW gate with the HW gate open starts/stops measurement.

The opening and closing of the HW gate with the SW gate open starts/stops measurement.

The SW gate is opened/closed by means of the control interface with the SW_GATE bit.

The HW gate is opened/closed by means of a 24-V signal on the digital input.

In isochronous mode, when the SW gate is open, measurement starts at time T_i , immediately after the HW gate has opened. The measurement ends at time T_i , which occurs immediately after the HW gate has closed.

When the HW gate is open, the measurement starts at time T_i in the cycle, immediately after the SW has opened, and ends at time T_i in the cycle, which occurs immediately after the SW gate has closed.

2.7.10 Behavior of the Output in Measurement Modes

Introduction

The various ways of setting the behavior of the output are described in this section.

Behavior of the Output in Measuring Modes

You can assign parameters for the digital output of the 1Count24V.

You can store a high and a low limit for frequency measurement, rotational speed measurement or period measurement. If the limits are violated, digital output DO1 is activated. These limit values can be assigned and changed with the load function.

You can change the function and the behavior of the digital output during operation. The new function takes effect immediately. In isochronous mode it always takes effect at time T_i .

You can choose from the following functions:

- Output
- Measured value outside the limits (limit-value monitoring)
- Measured value under the low limit (limit-value monitoring)
- Measured value over the high limit (limit-value monitoring)

Output

If you want to switch the output on or off, you must enable it with the CTRL_DO1 control bit.

You can switch the output on and off with the SET_DO1 control bit.

You can query the status of the output with the STS_DO1 status bit in the feedback interface.

In isochronous mode, the output is switched at time T_o .

Limit-Value Monitoring

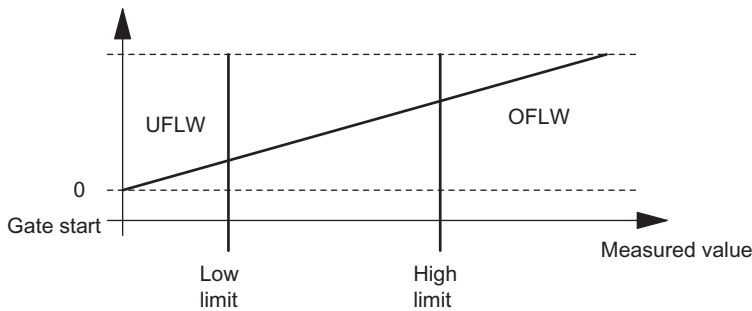

Figure 2-29 Limit-Value Monitoring

After the integration time elapses, the measured value obtained (frequency, rotational speed, or period) is compared with the assigned limit values.

If the current measured value is under the assigned low limit (measured value < low limit), the STS_UFLW = 1 bit is set in the feedback interface.

If the current measured value is over the assigned high limit (measured value > high limit), the STS_OFLW = 1 bit is set in the feedback interface.

You must acknowledge these bits with the RES_STS control bit.

If the measured value is still outside or again outside the limits after acknowledgment, the corresponding status bit is set again.

If you set the low limit at 0, you switch off dynamic monitoring of violation of the low limit value.

Depending on the parameter assignment, the enabled digital output DO1 can be set by the limit-value monitoring:

"Function DO1" parameter	DO1 is Set ...
Measured value outside the limits	Measured value < low limit OR measured value > high limit
Measured value under the low limit	Measured value < low limit
Measured value over the high limit	Measured value > high limit

In isochronous mode the output is switched at the end of measurement at time T_i .

2.7.11 Assignment of the Feedback and Control Interfaces for the Measurement Modes

Note

For the 1Count24V, the following data of the control and feedback interface are consistent:

Bytes 0 to 3

Bytes 4 to 7

Bytes 8 to 11 (modified user data interface)

Use the access or addressing mode for data consistency over the entire control and feedback interface on your master (only for configuration using the GSD file).

Assignment Tables

Table 2- 17 Feedback Interface (Inputs)

Address	Assignment	Designation
Bytes 0 to 3	Measured value	
Byte 4	Bit 7: Short circuit of the encoder supply Bit 6: Short circuit / wire break / overtemperature Bit 5: Parameter assignment error Bit 4: Reserve = 0 Bit 3: Reserve = 0 Bit 2: Resetting of status bits active Bit 1: Load function error Bit 0: Load function is running	ERR_24V ERR_DO1 ERR_PARA RES_STS_A ERR_LOAD STS_LOAD
Byte 5	Bit 7: Down direction status Bit 6: Up direction status Bit 5: Reserve = 0 Bit 4: Reserve = 0 Bit 3: DO1 status Bit 2: Reserve = 0 Bit 1: DI status Bit 0: Internal gate status	STS_C_DN STS_C_UP STS_DO1 STS_DI STS_GATE
Byte 6	Bit 7: Reserve = 0 Bit 6: Low limit of measuring range Bit 5: High limit of measuring range Bit 4: Reserve = 0 Bit 3: Measurement completed Bit 2: Reserve = 0 Bit 1: Reserve = 0 Bit 0: Reserve = 0	STS_UFLW STS_OFLW STS_CMP1
Byte 7	Reserve = 0	
Bytes 8 to 11	Count value ¹	
¹ Modified user data interface		

2.7 Measurement Modes

Table 2- 18 Control Interface (Outputs)

Address	Assignment			
Bytes 0 to 3	Low limit or high limit			
	Function of DO1			
	Byte 0:	Bit 1	Bit 0	Function DO1
		0	0	Output
		0	1	Measured value outside the limits
		1	0	Measured value under the low limit
	1	1	Measured value over the high limit	
	Bytes 1 to 3:	Reserve = 0		
	Integration time			
	Byte 0, 1:	Integration time [n*10ms] (Range 1 to 1000/12000)		
	Byte 2, 3:	Reserve = 0		
Byte 4	Bit 7:	Error diagnostics acknowledgement EXTf_ACK		
	Bit 6:	Reserve = 0		
	Bit 5:	Reserve = 0		
	Bit 4:	Enable DO1 CTRL_DO1		
	Bit 3:	Control bit DO1 SET_DO1		
	Bit 2:	Start resetting of status bit RES_STS		
	Bit 1:	Reserve = 0		
	Bit 0:	SW gate control bit SW_GATE		
Byte 5	Bit 7:	Reserve = 0		
	Bit 6:	Reserve = 0		
	Bit 5:	Reserve = 0		
	Bit 4:	Change function of DO1, C_DOPARAM		
	Bit 3:	Reserve = 0		
	Bit 2:	Change integration time, C_INTTIME		
	Bit 1:	Load high limit LOAD_PREPARE		
	Bit 0:	Load low limit LOAD_VAL		
Bytes 6 to 7	Reserve = 0 ¹			
¹ Not used for modified user interface				

Notes on the Control Bits

Table 2- 19 Notes on the Control Bits

Control bits	Notes
C_DOPARAM	Change function of DO1 The value from byte 0 is adopted as the new function of DO1.
C_INTTIME	Change integration time The value from bytes 0 and 1 is adopted as the new integration time for the next measurement.
CTRL_DO1	Enable DO1 You use this bit to enable the DO1 output.
EXTF_ACK	Error acknowledgment The error bits must be acknowledged with the EXTF_ACK control bit after the cause is removed.
LOAD_PREPARE	Load high limit The value from bytes 0 to 3 is adopted as the new high limit.
LOAD_VAL	Load low limit The value from bytes 0 to 3 is adopted as the new low limit.
RES_STS	Start resetting of status bit The status bits are reset through the acknowledgment process between the RES_STS bit and the RES_STS_A bit.
SET_DO1	Control bit DO1 Switches the DO1 digital output on and off when CTRL_DO1 is set.
SW_GATE	SW gate control bit The SW gate is opened/closed via the control interface with the SW_GATE bit.

Notes on the Feedback Bits

Table 2- 20 Notes on the Feedback Bits

Feedback bits	Notes
ERR_24V	Short circuit of the encoder supply The error bit must be acknowledged by the EXTF_ACK control bit. Diagnostic message if assigned.
ERR_DO1	Short circuit/wire break/overtemperature at output DO1 The error bit must be acknowledged by the EXTF_ACK control bit. Diagnostic message if assigned.
ERR_LOAD	Load function error The LOAD_VAL, LOAD_PREPARE, C_DOPARAM, and C_INTTIME bits cannot be set simultaneously during transfer. This results in setting the ERR_LOAD status bit, similar to loading an incorrect value (which is not accepted).
ERR_PARA	Parameter assignment error ERR_PARA
RES_STS_A	Resetting of status bits active
STS_C_DN	Down direction status
STS_C_UP	Up direction status
STS_CMP1	Measurement completed After every elapsed time interval (update time/integration time), the measured value is updated. Measurement with integration time The end of a measurement (after the interval has elapsed) is indicated with the STS_CMP1 status bit. Continuous measurement At the end of the update time, the end of the measurement is signaled with status bit STS_CMP1 if a measured value is output. The bit remains 0 if an estimated measured value is output. This bit is reset by the RES_STS control bit in the control interface.
STS_DI	DI status The status of the DI is indicated in all modes with the STS_DI bit in the feedback interface.
STS_DO1	DO1 status
STS_GATE	Internal gate status: Measuring
STS_LOAD	Load function is running
STS_OFLW	High measuring limit violated
STS_UFLW	Low measuring limit violated
	Both bits must be reset.

Access to the Control and Feedback Interface in STEP 7 Programming

Table 2- 21 Access to the Control and Feedback Interface in STEP 7 Programming

	Configuring with STEP 7 using the GSD file ¹⁾ (Hardware catalog\PROFIBUS-DP\Additional FIELD DEVICES\I/O\ET 200S)	Configuring with STEP 7 using HW Config (Hardware catalog\PROFIBUS-DP\ET 200S)
Feedback interface	Read with SFC 14 "DPRD_DAT"	Load command (e.g. L PID)
Control interface	Write with SFC 15 "DPWR_DAT"	Transfer command, e.g. T PQD
¹ Load and transfer commands are also possible with CPU 3xxC, CPU 3xx with MMC, CPU 4xx (V3.0 and later), and WinLC RTX (PC CPU).		

Resetting of the Status Bits STS_CMP1, STS_OFLW, STS_UFLW

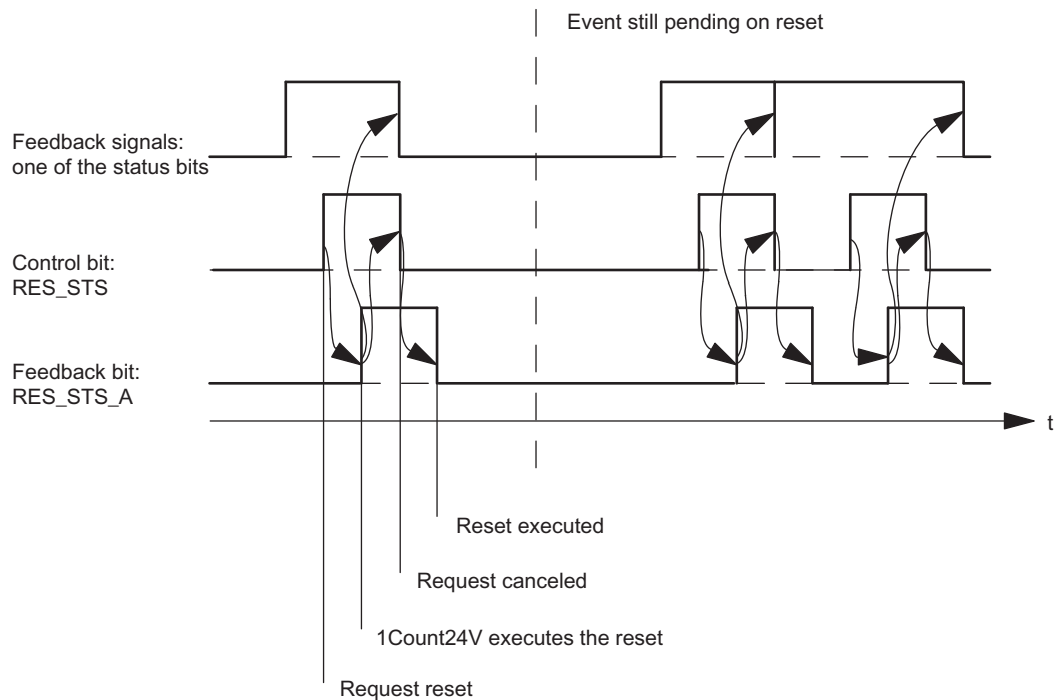

Figure 2-30 Resetting of the Status Bits

Acceptance of Values with the Load Function

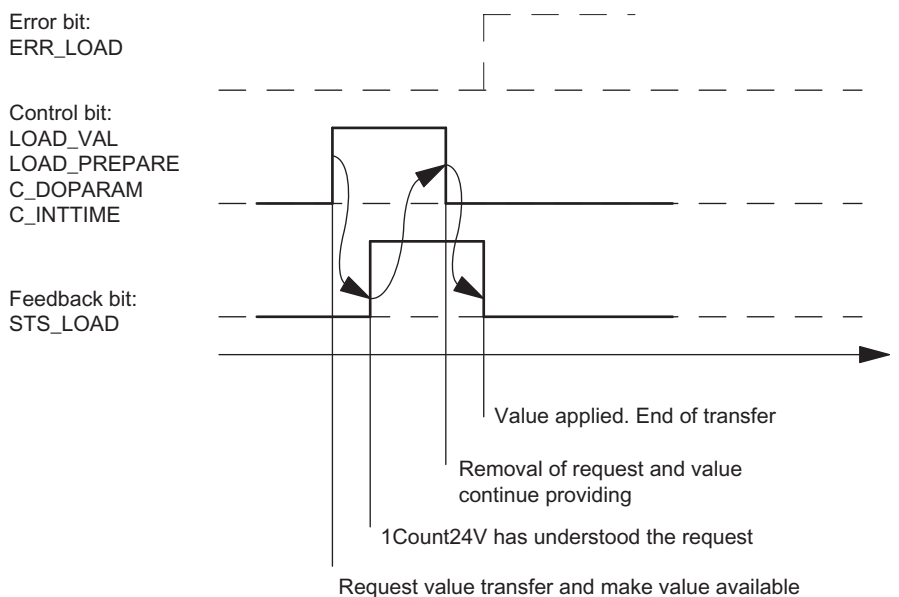

Figure 2-31 Acceptance of Values with the Load Function

Note

Only one of the following control bits can be set at a particular time:

LOAD_VAL or LOAD_PREPARE or C_DOPARAM or C_INTTIME.

Otherwise, the ERR_LOAD error is reported until all the specified control bits are deleted again.

The ERR_LOAD error bit is only deleted when a correct value is transferred as follows.

Acknowledgment Principle in Isochronous Mode

In isochronous mode, exactly 4 bus cycles are always required to reset the status bits and to accept values during the load function.

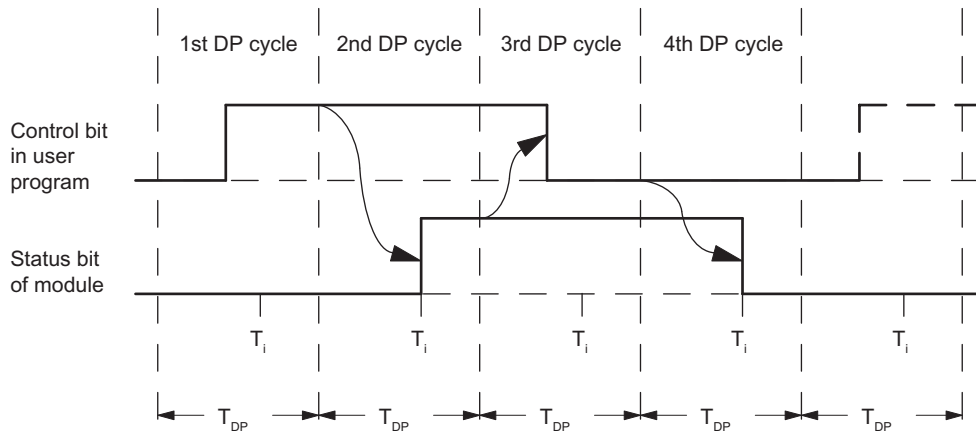

Figure 2-32 Acknowledgment Principle in Isochronous Mode

Error Detection

The diagnostic errors must be acknowledged. They have been detected by the 1Count24V and are indicated at the feedback interface. Channel-specific diagnostics are performed if you have enabled group diagnostics in your configuration (see device manual of the interface module used).

The parameter assignment error bit is acknowledged by means of correct parameter assignment.

An error has occurred, the 1Count24V sets an error bit, a diagnostic message may appear, error detection continues

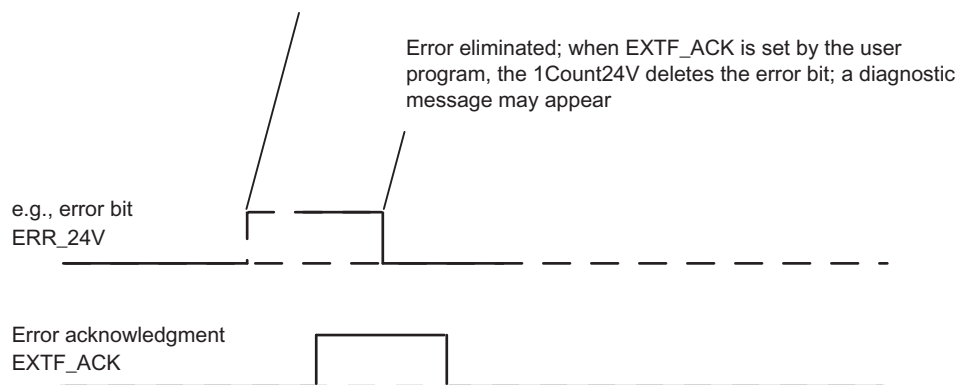

Figure 2-33 Error Acknowledgment

In the case of constant error acknowledgement ($EXTF_ACK = 1$) or in CPU/master STOP mode, the 1Count24V reports the errors as soon as they are detected and clears the errors as soon as they are eliminated.

2.7.12 Parameter Assignment for Measurement Modes

Introduction

You can use either of the following to assign parameters for the 1Count24V:

- STEP 7 V5.3 SP2 or later
- A GSD file (<http://www.automation.siemens.com/csi/gsd>)

Parameter List for Measuring Modes

Table 2- 22 Parameter List for Measuring Modes

Parameter	Value Range	Default
Enable		
Group diagnostics	Disable/enable	Disable
Response to failure of the higher-level controller		
Response to CPU/master STOP	Turn off DO1/ Continue working mode/ DO1 substitute a value/ DO1 keep last value	Turn off DO1
Encoder parameters		
Signal evaluation A, B	Pulse and direction/ Rotary encoder (single)	Pulse and Direction
Encoder and input filter		
- At count input (track A)	2.5 µs/25 µs	2.5 µs
- At direction input (track B)	2.5 µs/25 µs	2.5 µs
- At digital input DI	2.5 µs/25 µs	2.5 µs
Sensor A, B, DI	24V P switch, normal mode/ 24V M switch	24V P switch, normal mode
Direction input B	Normal/Inverted	Normal
Output parameters		
Diagnostics DO1 ¹	Off/on	Off
Function DO1	Output/ Outside the limits/ Under the low limit/ Over the high limit	Output
Substitute value DO1	0/1	0

Parameter	Value Range	Default
Mode		
Measuring mode	Frequency measurement/ Rotational speed measurement/ Period measurement	Frequency measurement
Measuring method	With integration time/continuous	With integration time
Resolution of period	1 μ s 1/16 μ s	1 μ s
Function DI	Input/HW gate	Input
Input signal HW gate	Normal/Inverted	Normal
Low limit	Frequency measurement: 0... $f_{max}-1$ Rotational speed measurement: 0... $n_{max}-1$ Period measurement: 0... $T_{max}-1$	0 0 0
High limit	Frequency measurement: low limit+1... f_{max} Rotational speed measurement: low limit+1... n_{max} Period measurement: low limit+1... T_{max}	f_{max} n_{max} t_{max}
Integration time [n*10ms] (update time)	Frequency measurement: 1 to 1000 Rotational speed measurement: 1 to 1000 Period measurement: 1 to 12000	10 10 10
Encoder pulses per revolution ²	1...65535	1
¹ DO1 diagnostics (wire break, short circuit) is possible only with pulse lengths of > 90 ms on digital output DO1. ² Only relevant in rotational speed measurement mode		

Parameter Assignment Error

The following parameter assignment errors may occur:

- Incorrect mode
- Low limit incorrect
- High limit incorrect
- Integration time incorrect
- Encoder pulses incorrect

What to Do in the Event of Errors

Check the set value ranges.

2.8 Fast mode

2.8.1 Overview

Introduction

This mode is suitable for position detection in especially short isochronous cycles.

This mode encompasses a subset of the functionality of the continuous counting mode.

It is intended for isochronous mode and differs from continuous counting by having a lower TDP $\text{Module}_{\text{min}}$ and a TWA equal to zero. The module is operated in this mode as a pure input module, i.e., there is no control interface in this operating mode.

This mode is available starting with FW Version V2.0 of the module. The module must be configured as "1Count24V Fast Mode V2.0" in HW Config.

You can find the parameter assignment for "Fast Mode" in the chapter "Assigning parameters for fast mode (Page 89)".

Maximum Count Range

A total of 25 bits are available for the count value.

Load Value

You can specify a load value for the 1Count24V.

This load value is applied directly as the start value.

Gate Control

To control the 1Count24V, you can use the HW gate.

State according to Parameter Assignment

Count value corresponds to the load value set in HW Config.

Isochronous Mode

In each cycle, the 1Count24V transfers the counter status and the status bits that were valid at time T_i .

2.8.2 Fast mode

Definition

In this mode, the 1Count24V counts continuously starting from the start value:

When counting up, if the 1Count24V reaches the maximum value that can be represented with 25 bits (all bits of the counter are set) and another count pulse arrives, the count value jumps to "0" and resumes counting from there without losing a pulse.

When counting down, if the 1Count24V reaches the value "0" and another count pulse arrives, the count value jumps to the maximum value that can be represented with 25 bits (all bits of the counter are set) and resumes counting without losing a pulse.

Function of the Digital Input

For the "Function DI" parameter, select between the following functions:

Digital input off.

- Input
- HW gate (see chapter "Gate function in the case of fast mode (Page 85)")
- Synchronization on positive edge (see chapter "Synchronization (Page 86)")

2.8.3 Gate function in the case of fast mode

Hardware Gate

The 1Count24V has a HW gate, which can be controlled via the digital input on the 1Count24V.

You assign the hardware gate as the function of the digital input (Function DI "HW Gate"). It is opened on a positive edge at the digital input and closed on a negative edge.

If no HW gate is assigned, counting becomes active immediately.

The STS_GATE checkback signal indicates whether counting is active.

When the HW gate is opened, this causes counting to continue starting from the current count.

2.8.4 Synchronization

Introduction

In order to use this function, you must first select it with the "Synchronize on Positive Edge" Function DI parameter.

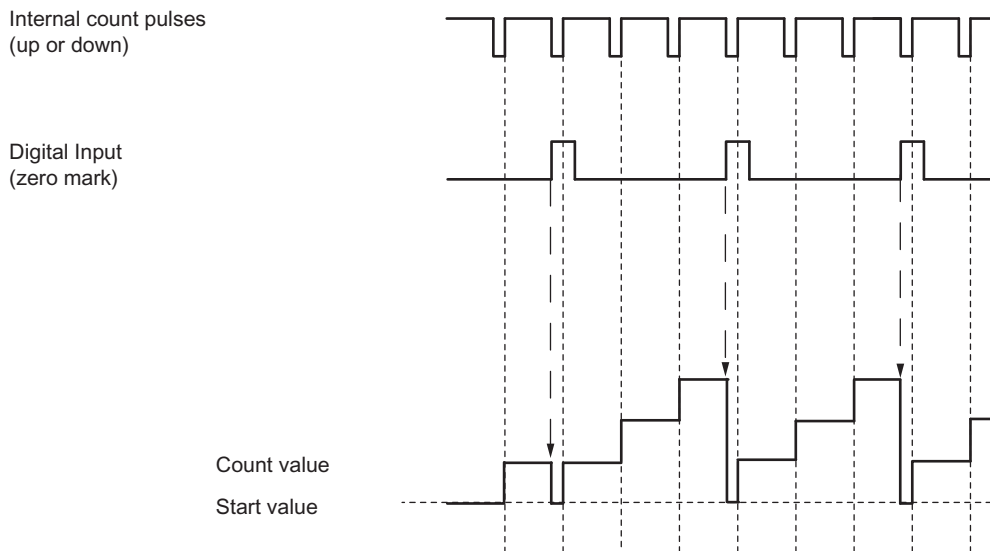

If you have assigned synchronization, the positive edge of a reference signal on the input sets the 1Count24V to the start value.

The following conditions apply:

- Fast mode must be active (HW gate).
 - When synchronization is activated, the first edge and each additional edge loads the 1Count24V with the start value.
- The signal of a bounce-free switch or the zero mark of a rotary encoder can serve as the reference signal.
- The STS_DI feedback bit indicates the level of the reference signal.

2.8.5 Assignment of feedback interface for fast mode

Note

For the 1Count24V, the following data of the feedback interface are consistent:

- Bytes 0 to 3

Use the access or addressing mode for data consistency over the entire control and feedback interface on your master (only for configuration using the GSD file).

Assignment Tables

Address	Assignment	Name	
Bytes 0 to 3	Bit 31	Sign of life	LZ
	Bit 30	Isochronous mode applied	STS_TIC
	Bit 29	Parameter assignment error	ERR_PARA
	Bit 28	Group error <ul style="list-style-type: none"> • Encoder supply short circuit 	EXTF
	Bit 27	DI status	STS_DI
	Bit 26	Status of direction up/down	STS_DIR
	Bit 25	Status of (internal) gate	STS_GATE
	Bits 0 to 24	Count value	

Notes on the Feedback Bits

Feedback bit	Notes
LZ	The sign of life is toggled on each update of the feedback interface, i.e. the last sent value is inverted.
STS_TIC	Isochronous mode (if assigned) was applied.
ERR_PARA	The assigned module parameters are faulty.
EXTF	Group error Possible cause: <ul style="list-style-type: none"> • Encoder supply short circuit EXTF is reset when the causes of the errors are eliminated.
STS_DI	The bit displays the status of the digital input DI.
STS_DIR	Status of direction; for encoder value change from larger to smaller encoder positions (including zero crossover) → "1 " for encoder value change from larger to smaller encoder positions (including zero crossover) → "0 "
STS_GATE	Status of (internal) gate: Counting

Access to the Feedback Interface in STEP 7 Programming

	Configuring with STEP 7 using HW Config
Feedback interface	Load command, e.g. L PID

Error Detection in Fast Mode

The encoder supply short circuit error is detected by the 1Count24V and indicated in the feedback interface (EXTF).

The fault indication in the feedback interface is extinguished as soon as this error is no longer detected by the 1Count24V.

The parameter error bit is acknowledged by means of a correct parameter assignment.

2.8.6 Assigning parameters for fast mode

Introduction

You use the following to assign parameters for the 1Count24V:

- STEP 7 Version 5.4 or higher; if necessary, the HSP (hardware support package) must be downloaded from the Internet

Parameter List for Fast Mode

Parameter	Value Range	Default
Response to failure of the higher-level controller		
Response to CPU/master STOP	Stop operating mode Continue operating mode	Stop operating mode
Basic parameters		
Signal evaluation A, B	Pulse and direction/ Rotary encoder single/double/quadruple	Pulse and direction
Encoder and input filter		
• At counter input (track A)	2.5 µs/25 µs	2.5 µs
• At direction input (track B)	2.5 µs/25 µs	2.5 µs
• At digital input DI	2.5 µs/25 µs	2.5 µs
Sensor A, B, DI	24V P switch, push-pull/ 24V M switch	24V P switch, push-pull
Direction input B	Normal/inverted	Normal
Mode		
Fast mode	Fast mode	Fast mode
Gate function	Cancel counting/ Interrupt counting	Cancel counting
Input signal HW gate	Normal/inverted	Normal
Function DI	Input / HW gate/ Synchronization at positive edge	Input
Load value	-16777216 ... +16777215	0

Parameter Assignment Error

- The "Input signal HW gate" parameter is set to inverted and the "Function DI" parameter is not set to HW gate.

What to Do in the Event of Errors

Check the set value ranges.

2.9 Position feedback

2.9.1 Overview

Description

This mode encompasses a subset of the functionality of the continuous counting mode. It is intended for isochronous mode and differs from continuous counting by a smaller T_{DP} Module_{min} and a T_{WA} equal to zero. This T_{WA} equal to zero makes it possible to operate the module as an input module only. In this case, however, the possible controls are no longer synchronized with T_o but rather are executed in the T_{DP} cycle before or after T_i .

To run this mode, you have to assign parameters to the 1Count24V (see section "Assigning Parameters for Position Feedback (Page 107)").

Maximum Count Range

The high counting limit is +2147483647 ($2^{31} - 1$).

The low counting limit is -2147483648 (-2^{31}).

Load value

You can specify a load value for the 1Count24V.

This load value is either applied directly as the new count value (LOAD_VAL) or it is applied as the new count value when the following events occur (LOAD_PREPARE):

- The counting operation is started by a SW gate or HW gate (if the counting operation is continued, the load value is not applied).
- Synchronization
- Latch and retrigger

Gate Control

To control the 1Count24V, you have to use the gate functions.

RESET States of the Following Values after Parameter Assignment

Table 2- 23 RESET States

Value	RESET state
Load value	0
Count value	0
Latch value	0

Isochronous mode

In isochronous mode, the 1Count24V accepts control bits and control values from the control interface in each bus cycle and reports back the response in this mode in the same cycle or in the next cycle.

In each cycle, the 1Count24V transfers the count or latch value that was valid at time T_i and the status bits valid at time T_i .

A count controlled by hardware input signals can only be transferred in the same cycle if the input signal occurred before time T_i .

2.9.2 Position Detection

Definition

In this mode, the 1Count24V counts continuously starting from the load value:

- If the 1Count24V reaches the high count limit when counting up, and another count pulse then comes, it will jump to the low count limit and continue counting from there without losing a pulse.
- If the 1Count24V reaches the low count limit when counting down, and another count pulse then comes, it will jump to the high count limit and continue counting from there without losing a pulse.
- The high counting limit is set at +2147483647 ($2^{31} - 1$).
- The low counting limit is set to -2147483648 (-2^{31}).

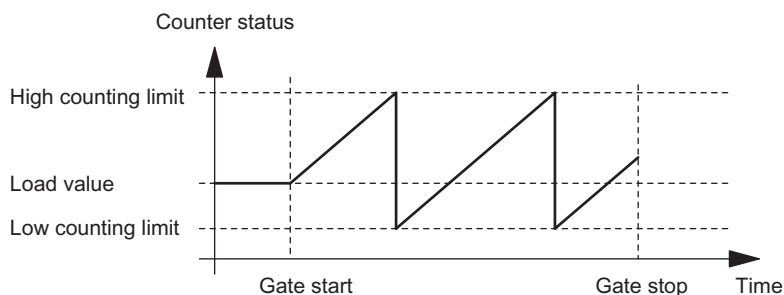

Figure 2-34 Count Continuously with Gate Function

Function of the Digital Input

For the "Function DI" parameter, select one of the following functions for the digital input:

- Input
- HW gate (see section "Gate Functions for Position Detection (Page 93)")
- Latch function (see section "Latch Function (Page 96)")
- Synchronization (see section "Synchronization (Page 99)")

2.9.3 Gate Functions for Position Detection

Software Gate and Hardware Gate

The 1Count24V has two gates

- A software gate (SW gate), which is controlled by the SW_GATE control bit.

The software gate can only be opened by a positive edge of the SW_GATE control bit. It is closed when this bit is reset. Note the transfer times and run times of your control program.

- A hardware gate (HW gate), which is controlled by means of the digital input on the 1Count24V.

You assign the hardware gate as the function of the digital input (Function DI "HW Gate"). It is opened on a positive edge at the digital input and closed on a negative edge.

Internal Gate

The internal gate is the logical AND operation of the HW gate and SW gate. Counting is only active when the HW gate and the SW gate are open. The STS_GATE feedback bit (internal gate status) indicates this. If a HW gate has not been assigned, the setting of the SW gate is decisive. Counting is activated, interrupted, continued, and canceled by means of the internal gate.

Canceling- and Interrupting-Type Gate Function

When assigning the gate function, you can specify whether the internal gate is to cancel or interrupt counting. When counting is canceled, after the gate is closed and restarted, counting starts again from the beginning. When counting is interrupted, after the gate is closed and restarted, counting continues from the previous value.

The diagrams below indicate how the interrupting and canceling gate functions work:

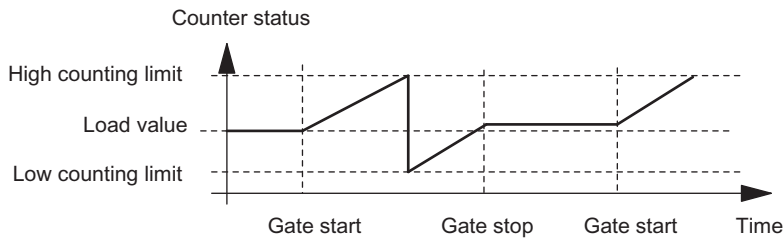

Figure 2-35 Position Detection, Up, Interrupting Gate Function

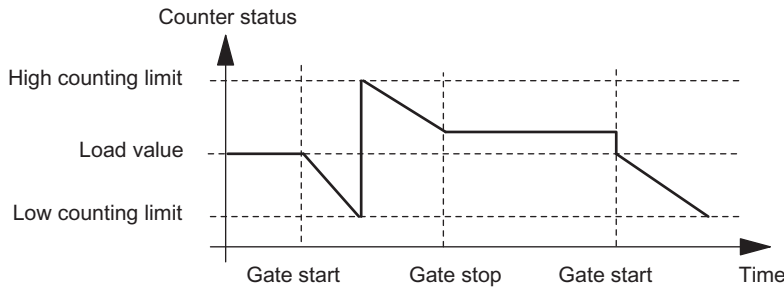

Figure 2-36 Position Detection, Down, Interrupting Gate Function

Gate Control

Gate control by means of the SW gate only

When the gate is opened, one of the following occurs, depending on the parameter assignment:

- Counting continues from the current counter status
- or
- Counting starts from the load value

If the SW gate is opened in isochronous mode in bus cycle "n" by setting the SW_GATE control bit, counting starts before or after T_i , depending on the position of T_i .

Gate control by means of the SW gate and HW gate

If the SW gate opens when the HW gate is already open, counting continues starting from the current counter status.

When the HW gate is opened, one of the following occurs, depending on the parameter assignment:

- Counting continues from the current counter status
- or
- Counting starts from the load value

If the SW gate is opened in isochronous mode in bus cycle "n" by setting the SW_GATE control bit, counting starts in cycle "n+1" before or after T_i , if the HW gate is already open at this time. If the HW gate opens after the SW gate has been opened, then counting does not start until the HW gate opens.

2.9.4 Latch Function

Overview

There are two latch functions:

- The Latch and Retrigger function
- The Latch function

The Latch and Retrigger Function

In order to use this function, you must first select it with the "Latch and Retrigger on Positive Edge" Function DI parameter.

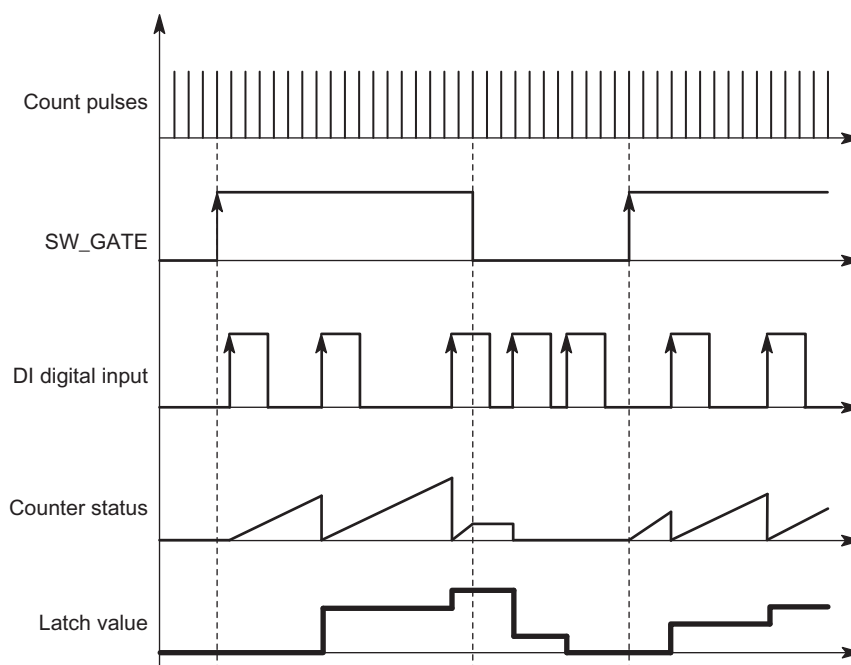

Figure 2-37 Latch and Retrigger with Load Value = 0

This function stores the current internal counter status of the 1Count24V and retriggers counting when there is a positive edge on the digital input. This means that the current internal counter status at the time of the positive edge is stored (latch value), and the 1Count24V is then loaded again with the load value, from which counting resumes.

The counting mode must be enabled with the SW gate before the function can be executed. It is started with the first positive edge on the digital input.

The stored counter status rather than the current counter status is indicated in the feedback interface. The STS_DI bit indicates the status of the latch and retrigger signal.

The latch value is preassigned with its RESET state (see corresponding table). It is not changed when the SW gate is opened.

Direct loading of the counter does not cause the indicated stored counter status to be changed.

If you close the SW gate, it only interrupts counting; this means that when you open the SW gate again, counting is continued. The digital input DI remains active even when the SW gate is closed.

Counting is also latched and triggered in isochronous mode with each edge on the digital input. The counter status that was valid at the time of the last edge before T_i is displayed in the feedback interface.

The Latch Function

In order to use this function, the Function DI parameter "Latch on Positive Edge" must be selected for the digital input.

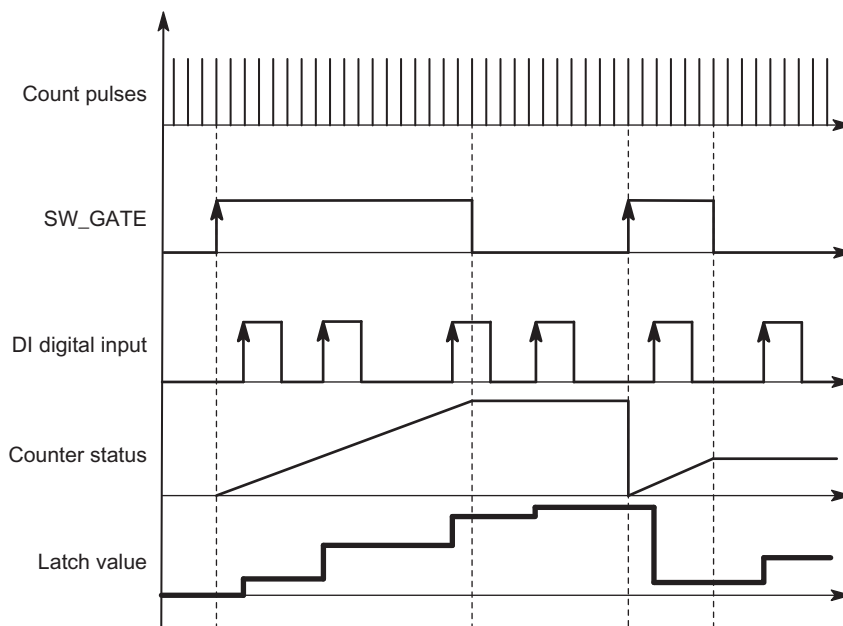

Figure 2-38 Latch with a Load Value of 0

Counter status and latch value are preset with their RESET states (see corresponding table).

The counting function is started when the SW gate is opened. The 1Count24V begins at the load value.

The latch value is always the exact counter status at the time of the positive edge on the digital input DI.

The stored counter status rather than the current counter status is indicated in the feedback interface. The STS_DI bit indicates the level of the latch signal.

Direct loading of the counter does not cause the indicated stored counter status to be changed.

In isochronous mode, the counter status that was latched at the time of the last positive edge before T_i is displayed in the feedback interface.

When you close the SW gate, the effect is either canceling or interrupting, depending on the parameter assignment. The digital input DI remains active even when the SW gate is closed.

Further possible causes of parameter assignment errors with the latch function:

- Incorrect parameter assignment of the digital output function (Function DI)

Modified User Data Interface

If the 1Count24V is inserted behind an IM 151 that supports the reading and writing of broader user data interfaces, the current count value can be read from bytes 8 to 11 of the feedback interface.

2.9.5 Synchronization

Synchronization

In order to use this function, you must first select it with the "Synchronize on Positive Edge" Function DI parameter.

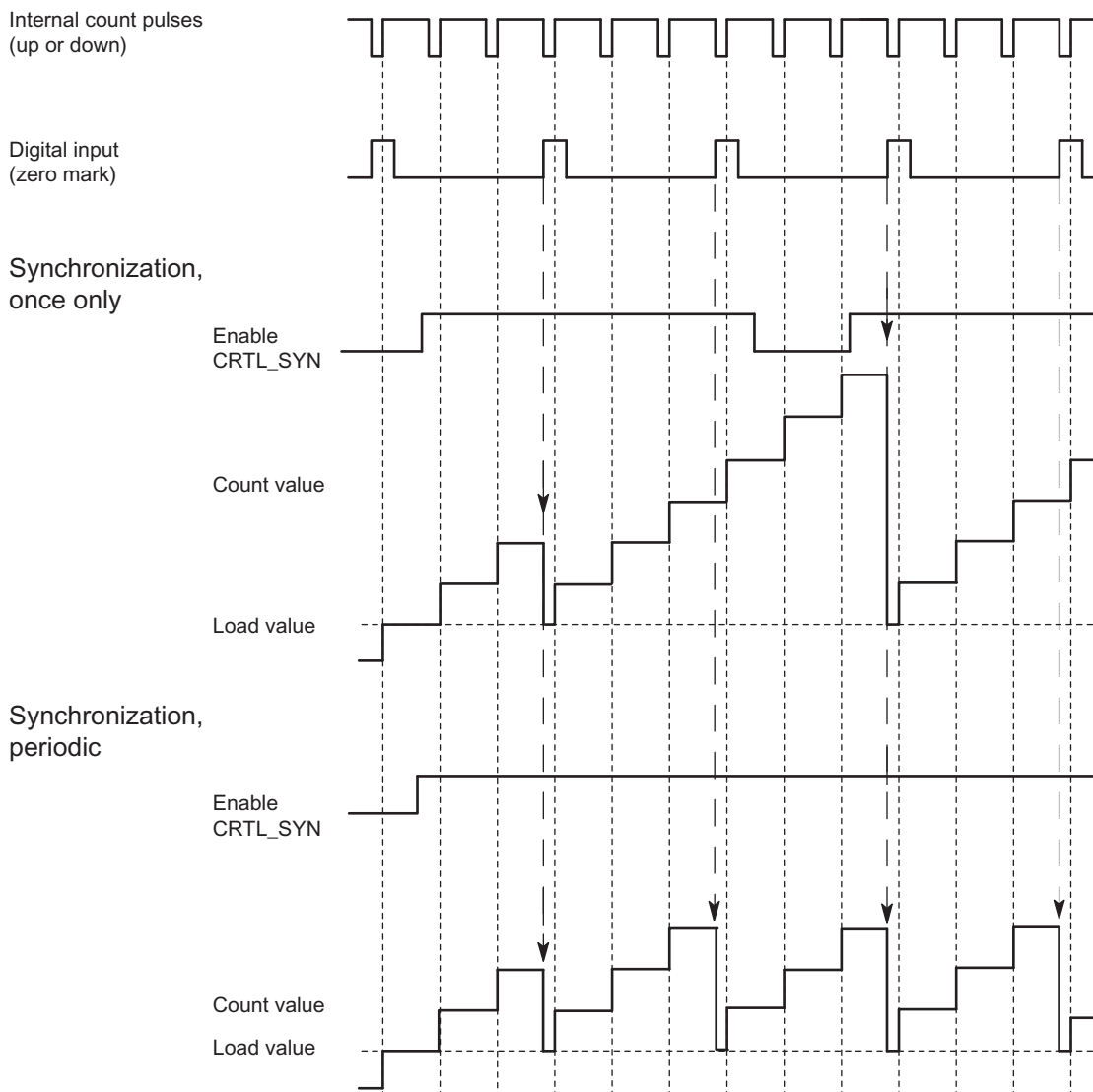

Figure 2-39 Once-Only and Periodic Synchronization

If you have configured synchronization, the positive edge of a reference signal on the input sets the 1Count24V to the load value.

You can select between once-only and periodic synchronization ("Synchronization" parameter).

The following conditions apply:

- The counting mode must have been started with the SW gate.
- The "Enable synchronization CTRL_SYN" control bit must be set.
- Synchronize once only: If the enable bit is set, the first edge loads the 1Count24V with the load value.
- Synchronization periodically: If the enable bit is set, the first and every further edge loads the 1Count24V with the load value.
- After successful synchronization, the STS_SYN feedback bit is set. It must be reset by the RES_STS control bit.
- The signal of a bounce-free switch or the zero mark of a rotary encoder can serve as the reference signal.
- The STS_DI feedback bit indicates the level of the reference signal.

In isochronous mode, the set feedback bit STS_SYN indicates that the positive edge on the digital input was between time T_i in the current cycle and T_i in the previous cycle.

2.9.6 Assignment of the Feedback and Control Interface for Position Feedback

Note

For the 1Count24V, the following data of the control and feedback interface are consistent:

Bytes 0 to 3

Bytes 4 to 7

Bytes 8 to 11 (modified user data interface)

Use the access or addressing mode for data consistency over the entire control and feedback interface on your master (only for configuration using the GSD file).

Assignment Tables

Table 2- 24 Feedback Interface (Inputs)

Address	Assignment	Designation
Bytes 0 to 3	Count value or stored count value in the case of the latch function on the digital input	
Byte 4	Bit 7: Short circuit of the encoder supply Bit 6: Reserve = 0 Bit 5: Parameter assignment error Bit 4: Reserve = 0 Bit 3: Reserve = 0 Bit 2: Resetting of status bits active Bit 1: Load function error Bit 0: Load function is running	ERR_24V ERR_PARA RES_STS_A ERR_LOAD STS_LOAD
Byte 5	Bit 7: Down direction status Bit 6: Up direction status Bit 5: Reserve = 0 Bit 4: Reserve = 0 Bit 3: Reserve = 0 Bit 2: Reserve = 0 Bit 1: DI status Bit 0: Internal gate status	STS_C_DN STS_C_UP STS_DI STS_GATE
Byte 6	Bit 7: Zero crossing Bit 6: Low counting limit Bit 5: High counting limit Bit 4: Reserve = 0 Bit 3: Reserve = 0 Bit 2: Reserve = 0 Bit 1: Reserve = 0 Bit 0: Synchronization status	STS_ND STS_UFLW STS_OFLW STS_SYN
Byte 7	Reserve = 0	
Bytes 8 to 11	Count value ¹	

¹ Modified user data interface

Table 2- 25 Control Interface (Outputs)

Address		Assignment	
Bytes 0 to 3		Load value direct, preparatory, comparison value 1 or 2	
Byte 0		Behavior of DO1, DO2 of the 1Count24V	
		Bit 2 Bit 1 Bit 0 Function DO1	
		0 0 0 Output	
		0 0 1 Switch on at count \geq comparison value	
		0 1 0 Switch on at count \leq comparison value	
		0 1 1 Pulse on reaching the comparison value	
		1 0 0 Switch at comparison values	
		1 0 1 blocked	
		1 1 0 blocked	
		1 1 1 blocked	
		Bit 5 Bit 4 Function DO2	
		0 0 Output	
		0 1 Switch on at count \geq comparison value	
		1 0 Switch on at count \leq comparison value	
		1 1 Pulse on reaching the comparison value	
		Bits 3, 6, and 7: Reserve = 0	
Bytes 1 to 3	Byte 1:	Hysteresis DO1, DO2 (range 0 to 255)	
	Byte 2:	Pulse duration [2ms] DO1, DO2 (range 0 to 255)	
	Byte 3:	Reserve = 0	
Byte 4	EXTF_ACK RES_STS CTRL_SYN SW_GATE	Bit 7:	Error diagnostics acknowledgment
		Bit 6:	Reserve = 0
		Bit 5:	Reserve = 0
		Bit 4:	Reserve = 0
		Bit 3:	Reserve = 0
		Bit 2:	Start resetting of status bit
		Bit 1:	Enable synchronization
Bit 0:	SW gate control bit		
Byte 5	LOAD_PREPARE LOAD_VAL	Bit 7:	Reserve = 0
		Bit 6:	Reserve = 0
		Bit 5:	Reserve = 0
		Bit 4:	Reserve = 0
		Bit 3:	Reserve = 0
		Bit 2:	Reserve = 0
		Bit 1:	Load counter preparatory
Bit 0:	Load counter direct		
Bytes 6 to 7		Reserve = 0 ¹	

¹ Not used for modified user interface

Notes on the Control Bits

Table 2- 26 Notes on the Control Bits

Control bits	Notes
CTRL_SYN	You use this bit to enable synchronization.
EXTF_ACK	Error acknowledgment The error bits must be acknowledged with the EXTF_ACK control bit after the cause is removed.
LOAD_PREPARE	Load counter preparatory The value from bytes 0 to 3 is applied as the load value.
LOAD_VAL	The value from bytes 0 to 3 is loaded directly as the new count value.
RES_STS	Start resetting of status bit The status bits are reset through the acknowledgment process between the RES_STS bit and the RES_STS_A bit.
SW_GATE	The SW gate is opened/closed via the control interface with the SW_GATE bit.

Notes on the Feedback Bits

Table 2- 27 Notes on the Feedback Bits

Feedback bits	Notes
ERR_24V	Short circuit of the encoder supply The error bit must be acknowledged by the EXTF_ACK control bit. Diagnostic message if assigned.
ERR_LOAD	Load function error The LOAD_VAL, LOAD_PREPARE, CMP_VAL1, CMP_VAL2, and C_DOPARAM bits cannot be set simultaneously during transfer. This results in setting the ERR_LOAD status bit, similar to loading an incorrect value (which is not accepted).
ERR_PARA	Parameter assignment error ERR_PARA
RES_STS_A	Resetting of status bits active
STS_C_DN	Down direction status
STS_C_UP	Up direction status
STS_DI	DI status The status of the DI is indicated in all modes with the STS_DI bit in the feedback interface.
STS_GATE	Internal gate status: Counting
STS_LOAD	Load function is running
STS_ND	Zero-crossing in the count range when counting without a main counting direction. The bit must be reset by the RES_STS control bit.
STS_OFLW STS_UFLW	High counting limit violated Low counting limit violated Both bits must be reset.
STS_SYN	Synchronization status: After successful synchronization, the STS_SYN bit is set. It must be reset by the RES_STS control bit.

Access to the Control and Feedback Interface in STEP 7 Programming

Table 2- 28 Access to the Control and Feedback Interface in STEP 7 Programming

	Configuring with STEP 7 using the GSD file ¹⁾ (Hardware catalog\PROFIBUS-DP\Additional FIELD DEVICES\I/O\ET 200S)	Configuring with STEP 7 using HW Config (Hardware catalog\PROFIBUS-DP\ET 200S)
Feedback interface	Read with SFC 14 "DPRD_DAT"	Load command (e.g. L PID)
Control interface	Write with SFC 15 "DPWR_DAT"	Transfer command (e.g. T PQD)
¹ Load and transfer commands are also possible with CPU 3xxC, CPU 3xx with MMC, CPU 4xx (V3.0 and later), and WinLC RTX (PC CPU).		

Resetting of the Status Bits STS_SYN, STS_OFLW, STS_UFLW, STS_ND

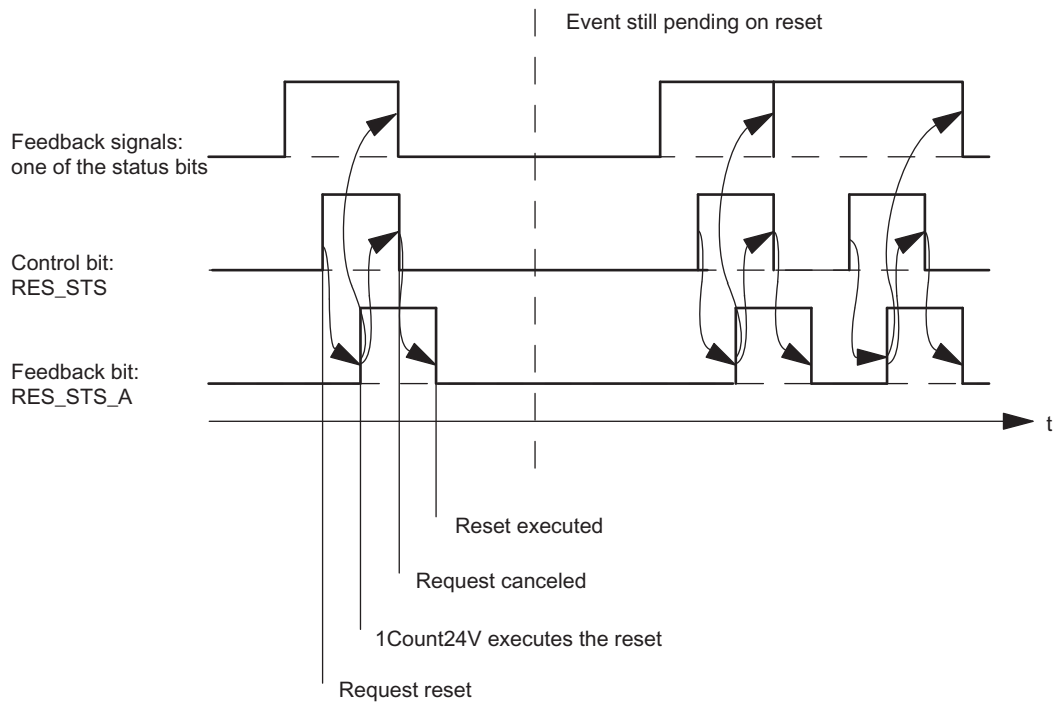

Figure 2-40 Resetting of the Status Bits

Acceptance of Values with the Load Function

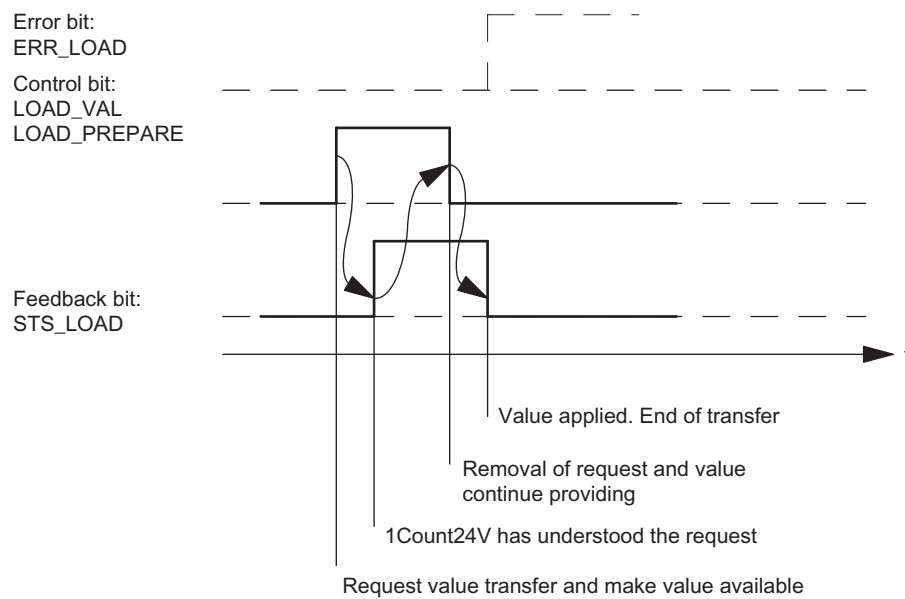

Figure 2-41 Acceptance of Values with the Load Function

Note

Only one of the following control bits can be set at a particular time:

LOAD_VAL or LOAD_PREPARE.

Otherwise, the ERR_LOAD error is reported until all the specified control bits are deleted again.

The ERR_LOAD error bit is only deleted when a correct value is transferred as follows.

Acknowledgment Principle in Isochronous Mode

In isochronous mode, exactly 4 or 6 bus cycles are always required to reset the status bits and to accept values during the load function.

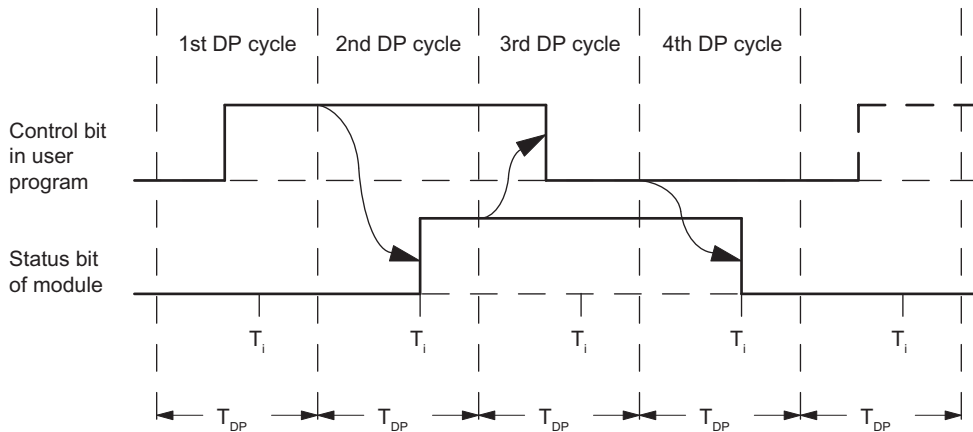

Figure 2-42 Acknowledgment Principle in Isochronous Mode

Error Detection

The program errors must be acknowledged. They have been detected by the 1Count24V and are indicated at the feedback interface. Channel-specific diagnostics are performed if you have enabled group diagnostics in your configuration (see device manual of the interface module used).

The parameter assignment error bit is acknowledged by means of correct parameter assignment.

An error has occurred, the 1Count24V sets an error bit, a diagnostic message may appear, error detection continues

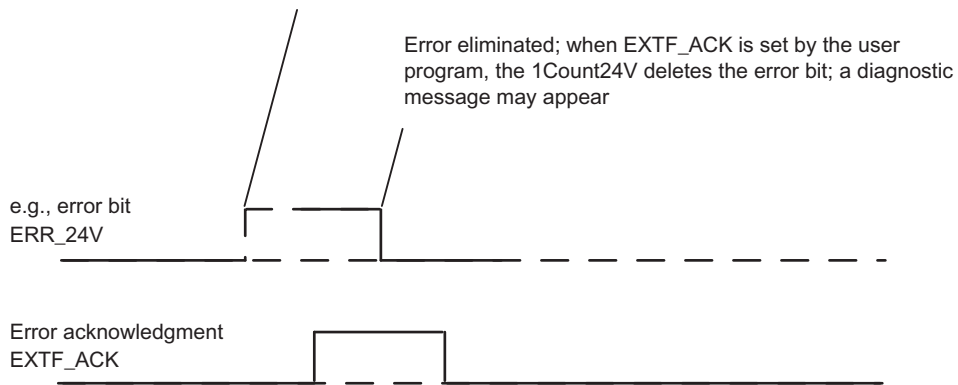

Figure 2-43 Error Acknowledgment

In the case of constant error acknowledgement ($EXT_F_ACK = 1$) or in CPU/master STOP mode, the 1Count24V reports the errors as soon as they are detected and clears the errors as soon as they are eliminated.

2.9.7 Assigning Parameters for Position Feedback

Introduction

You can use either of the following to assign parameters for the 1Count24V:

- STEP 7 V5.3 SP2 or later
- A GSD file (<http://www.automation.siemens.com/csi/gsd>)

Parameter List for Position Feedback

Table 2- 29 Parameter List for Position Feedback

Parameter	Value Range	Default
Enable		
Group diagnostics	Disable/enable	Disable
Response to failure of the higher-level controller		
Response to CPU/master STOP	Turn off Continue working mode	Turn off
Encoder parameters		
Signal evaluation A, B	Pulse and direction/ Rotary encoder single/double/quadruple	Pulse and direction
Encoder and input filter - At count input (track A) - At direction input (track B) - At digital input DI	2.5 µs/25 µs 2.5 µs/25 µs 2.5 µs/25 µs	2.5 µs 2.5 µs 2.5 µs
Sensor A, B, DI	24V P switch, normal mode/ 24V M switch	24V P switch, normal mode
Direction input B	Normal/Inverted	Normal
Mode		
Position feedback	Position detection	Position detection
Gate function	Cancel counting/ Interrupt counting	Cancel counting
Input signal HW gate	Normal/Inverted	Normal
Function DI	Input / HW gate / Latch and retrigger at positive edge / Synchronization at positive edge / Latch at positive edge	Input
Synchronization ¹	Once-only/Periodic	Once-only

¹ Only relevant if Function DI = Synchronization at positive edge

Parameter Assignment Error

- The "Input signal HW gate" parameter is set to inverted and the "Function DI" parameter is not set to HW gate.

What to Do in the Event of Errors

Check the set value ranges.

2.10 Evaluation of count and direction signal

Signal Evaluation A, B

Signal evaluation by means of A, B allows you to count directionally. Different evaluation modes are possible depending on the parameter assignment:

- Pulse and direction
- Rotary encoder

In the case of 24-V pulse generators with a direction indicator, there must be a time span of at least 5 μ s/50 μ s between the direction signal (B*) and the count signal (A*), depending on the input filter that has been assigned parameters.

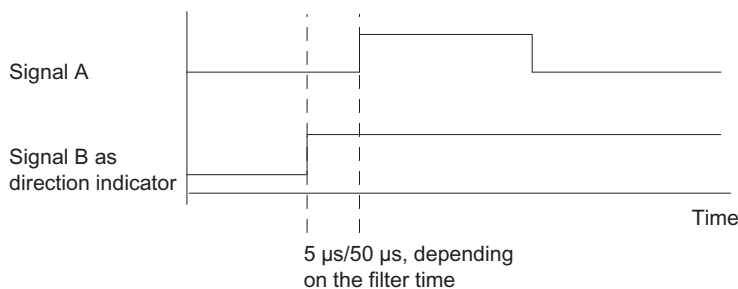

Figure 2-44 Time Span between the Direction Signal and the Count Signal

If you connect a 24-V rotary encoder with two tracks that are 90 degrees out of phase at the count and direction inputs, you can assign parameters to a single evaluation in all the measurement and count modes.

You can also assign parameters to dual or quad evaluation in all count modes.

In all evaluation modes, you can invert direction detection at input B by parameter assignment.

The count and direction inputs can be operated with different sensors (P switch and series mode or M switch).

Note

If you have selected the 24V M switch setting with the 1Count24V for the "Sensor A, B, DI" parameter, you must use the M-switching sensors.

Pulse and Direction

The level at direction input B is used as the direction setting.

An unwired input corresponds to the "Up" count direction if you have selected "Pulse/direction" for the "Signal evaluation" parameter.

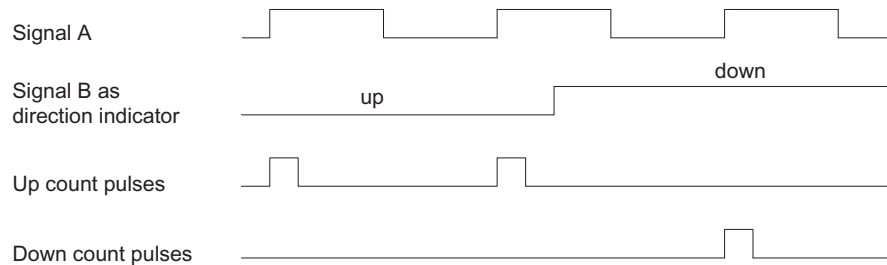

Figure 2-45 Signals of a 24-V Pulse Generator with Direction Indicator

Rotary Encoder

The 1Count24V can count the edges of the signals. Normally, only the edge at A is evaluated (single evaluation). To obtain a higher resolution, when assigning parameters ("Signal Evaluation" parameter), you can select whether the signals are to be subjected to single, double, or quadruple evaluation.

Multiple evaluation is only possible with asymmetric incremental encoders with A and B signals that are 90 degrees out of phase.

Single Evaluation

Single evaluation means that only one edge of A is evaluated; up count pulses are recorded at a positive edge at A and low level at B, and down count pulses are recorded at a negative edge at A and low level at B.

The diagram below illustrates the single evaluation of the signals.

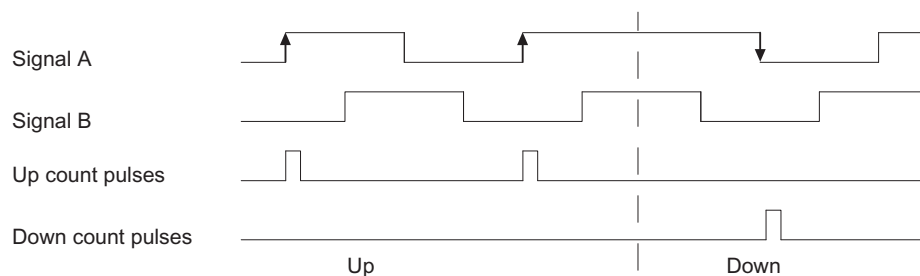

Figure 2-46 Single Evaluation

Double Evaluation

Double evaluation means that the positive and negative edge of the A signal are evaluated. Whether up or down count pulses are generated depends on the level of the B signal.

The diagram below illustrates the double evaluation of the signals.

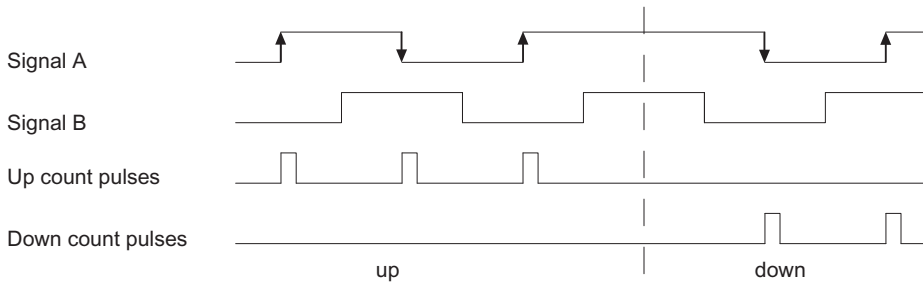

Figure 2-47 Double Evaluation

Quadruple Evaluation

Quadruple evaluation means that the positive and negative edges of the A and B signals are evaluated. Whether up or down count pulses are generated depends on the levels of the A and B signals.

The diagram below illustrates the quadruple evaluation of the signals.

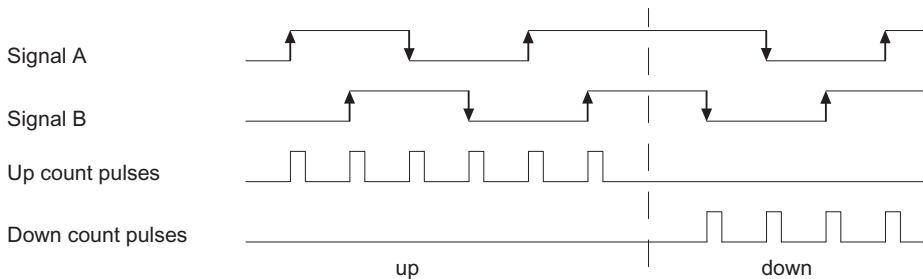

Figure 2-48 Quadruple Evaluation

Note

A counting frequency of 100 kHz refers to the maximum frequency of the A and B signals. With double evaluation, a maximum frequency of 200 kHz is produced for the counting pulses; with quadruple evaluation, the maximum frequency is 400 kHz.

2.11 Diagnostics

2.11.1 Diagnostics using the LED display

LED display on the 1Count24V

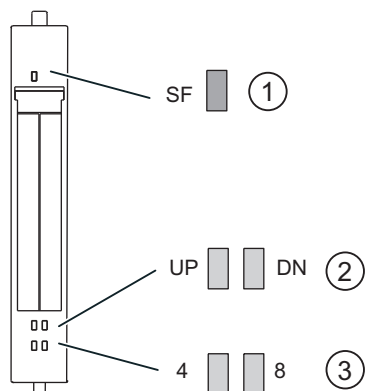

- ① Group error (red)
- ② Status display for counting direction (green)
- ③ Status display for digital input/digital output (green)

Status and error displays by means of LEDs on the 1Count24V

The table below shows the status and error displays on the 1Count24V.

Event (LEDs)					Cause	Remedy
SF	UP	DN	4	8		
On					No configuration or incorrect module plugged in. There is a diagnostic message.	Check the parameter assignment. Evaluate the diagnostics data.
	On				Status of the low-order bits of the counter, if the counter counts up.	
		On			Status of the inverse low-order bits of the counter, if the counter counts down.	
			On		DO (direct control, comparator output) activated.	
				On	DI (HW gate, synchronization, latch) activated.	

2.11.2 Error types

For information on the structure of the channel-related diagnostics, refer to the manual on the interface module used in your ET 200S station.

1Count24V error types

The following table shows the error types on the 1Count24V.

Error type		Meaning	Remedy
1D	00001: Short circuit	Short circuit of the sensor supply or the actuator.	Check the wiring to the sensor. Correct the process wiring.
5D	00101: Overtemperature	The digital output is overloaded.	Correct the process wiring.
6D	00110: Cable break	Line to the actuator is interrupted.	Correct the process wiring.
9D	01001: Error	Internal module error occurred.	Replace the module.
		Load voltage from the power module is too low.	Correct the process wiring. Check the load voltage.
16D	10000: Parameter assignment error	Parameters have not been assigned to the module.	Correct the parameter assignment.

2.12 Behavior at CPU-Master-STOP

Setting the response to CPU/master STOP

You can configure the reaction of the 1Count24V to failure of the higher-level controller.

Parameter	Status of the 1Count24V at CPU/master STOP	What Happens if New Parameters Have Been Assigned?
Turn off DO1	The current mode is canceled, the gate closed, and the digital output blocked; comparison values 1 and 2 and the load value are reset; the high and low limit values, function and behavior of the digital outputs and the integration time are handled in accordance with the parameter assignments.	The changed parameters are accepted and take effect.
Continue working mode ¹	The current mode continues, and the gate and digital output retain their status.	The gate is closed, the current mode is terminated, the digital output is blocked, and the changed parameters are accepted and take effect.
DO 1 substitute a value	The current mode is canceled, the gate closed, and the digital output blocked; comparison values 1 and 2 and the load value are reset; the high and low limit values, function and behavior of the digital outputs and the integration time are handled in accordance with the parameter assignments. When a pulse is output when the comparison value is reached, the substitute value is 1 only for the duration of the pulse.	The changed parameters are accepted and take effect.
DO 1 keep last value	The current mode is canceled, the gate closed, and the digital output blocked; comparison values 1 and 2 and the load value are reset; the high and low limit values, function and behavior of the digital outputs and the integration time are handled in accordance with the parameter assignments.	The changed parameters are accepted and take effect.
¹ If the mode is to continue during a change from CPU-/Master-STOP to RUN (startup), the CPU/Master must not clear the outputs. Possible solution: In the part of the user program that is executed during startup, set the SW gate control bit and transfer the values to the 1Count24V.		

Leaving the Assigned State

Under what conditions does the 1Count24V leave the assigned state?

The CPU or master must be in RUN mode, and you have to make a change at the control interface.

Automatic New Parameter Assignment

A new parameter assignment of the ET 200S station is made by your CPU/ DP master:

- Upon power on of the CPU/DP master
- Upon power on of the IM 151/IM 151 FO
- After failure of the DP transmission
- Upon loading changed parameters or configuration of the ET 200S station to the CPU/DP master
- When the 1Count24V is plugged
- Upon power on or inserting of the appropriate power module

2.13 Technical Specifications

Technical specifications

General technical specifications	
Dimensions and Weight	
Dimensions W x H x D (mm)	15x81x52
Weight	Approx. 40 g
Data for Specific Modules	
Number of Channels	1
Counter range	32 bits
Voltages, Currents, Potentials	
Rated load voltage L+ • Reverse polarity protection	24 VDC Yes
Galvanic isolation • Between backplane bus and counter function • Between counter function and load voltage	Yes No
Encoder supply • Output voltage • Output current	L+ (-0.8 V) Max. 500 mA (Total current at terminals 2 and 6), short circuit proof
Current consumption • From the backplane bus • From load voltage L+ (no load)	max. 10 mA max. 42 mA
Power dissipation	Typ. 1 W
Data on the counting signals and the digital input	
Galvanic isolation	No, from shield only
Input voltage • Rated value • 0 signal • 1 signal	24 VDC -30 V to 5 V 11 V to 30 V
Input current • 0 signal • 1 signal	≤2 mA (quiescent current) 9 mA (typically)
Minimum pulse width (maximum counting frequency) • Filter on • Filter off	≥ 25 μs ≥ 2.5 μs
Connection of a two-wire BERO type 2	Possible
Input characteristic	In accordance with IEC 1131, Part 2, Type 2
Shielded cable length • Filter 200 kHz • Filter 20 kHz	50 m 100 m

General technical specifications	
Data for the Digital Output	
Output voltage <ul style="list-style-type: none"> Rated value 0 signal 1 signal 	24 VDC $\leq 3V$ $\geq L+ (-1V)$
Output current <ul style="list-style-type: none"> 0 signal (residual current) 1 signal <ul style="list-style-type: none"> Permitted range Rated value 40°C 50°C 60°C	$\leq 0.5 \text{ mA}$ 5 mA to 2.0 A 2 A 1 A 0.5 A
Switching frequency <ul style="list-style-type: none"> Resistive load Inductive load Lamp load 	100 Hz 2 Hz $\leq 10 \text{ Hz}$
Lamp load Output delay (resistive load) Short circuit protection for output Response threshold Inductive extinction Digital input control Cable lengths <ul style="list-style-type: none"> Unshielded Shielded 	$\leq 5 \text{ W}$ 100 μs Yes 2.6 A to 4 A Yes; L+ -(50 to 60 V) Yes 600 m 1000 m
Status, Diagnostics	
Digital input DI status display Digital output DO status display Up count value change Down count value change Fault indicator Diagnostic information	LED 8 (green) LED 4 (green) UP LED (green) DN LED (green) SF LED (red) Yes
Measuring Ranges in the Measuring Modes	
Maximum measuring range <ul style="list-style-type: none"> Frequency measurement Rotational speed measurement Period measurement 	0.1 Hz to 100 kHz 1/min ... 25000 /min 10 μs ... 120 s
Response times	
Update rate of the counting modes <ul style="list-style-type: none"> Non-isochronous mode Isochronous mode 	1 ms T_{DP}

General technical specifications	
Isochronous Times of the Module	
in counting modes	
TCI	380 μ s
TCO	320 μ s
T _{oi} Min	55 μ s
T _{DP} Min	900 μ s
in measuring modes	
TCI	465 μ s
TCO	280 μ s
T _{oi} Min	50 μ s
T _{DP} Min	995 μ s
in position feedback	
TCI	370 μ s
TCO	0 μ s
T _{oi} Min	0 μ s
T _{DP} Min	815 μ s

1Count5V

3.1 Product Overview

Order Number:

6ES7 138-4DE02-0AB0

Compatibility

The 1Count5V with the order number 6ES7 138-4DE02-0AB0 replaces the 1Count5V/500kHz with the order number 6ES7 138-4DE01-0AB0 with full compatibility. In STEP 7 version V5.3 SP2 and later, you can use it in non-isochronous and isochronous modes.

Features

- A 5 V incremental encoder can be connected in order to count 5 V RS422 signals up to a frequency of 500 kHz.
- The 1Count5V is a double-width module and can only be used with a 4-row terminal module (e. g. TM-E30S44-01).
- Isochronous mode
- Modified user data interface ¹

¹ Instead of 8 bytes of input data and 8 bytes of output data, 12 bytes of input data and 6 bytes of output data are used, provided the IM 151 supports this.

The following IM 151 modules support this function:

- IM151-1/Standard order no. 6ES7 151-1AA04-0AB0 and higher
- IM151-1/HF order no. 6ES7 151-1BA01-0AB0 and higher

- Operating modes of the 1Count5V:

Counting modes:

- Count continuously
- Count once
- Count periodically

Measuring modes:

- Frequency measurement
- Rotational speed measurement
- Period measurement

Position feedback:

- Position detection
- Fast mode

- Gate control, synchronization or latch function via digital inputs
- 2 digital outputs for direct control or output of the comparison results.
- Firmware update ¹
- Identification data ¹

¹ The following IM 151 modules support this function: IM 151-1 Standard: 6ES7151-1AA04-0AB0 and later and IM 151-1 High Feature: 6ES7151-1BA01-0AB0 and later.

Connectable Counting Signals

The 1Count5V can count the signals of the following encoders:

- 5 V incremental encoder with two tracks that are 90° out of phase at the count inputs.

Adjustment During Operation

- Counting modes
 - You can change the function and behavior of the digital outputs during operation.
- Measuring modes
 - You can change the function of the DO1 digital output during operation
 - You can change the integration time/update time during operation

Configuration

In order to configure the 1Count5V use

- STEP 7 V5.3 SP2 or higher
- The HSP (hardware support package, available online) as of STEP 7 Version V5.2 SP1

Firmware update

In order to extend the functionality and eliminate errors, firmware updates can be downloaded to the operating system memory of the 1Count5V by means of the STEP 7 HW Config software.

Note

When you launch the firmware update, the old firmware is deleted. If the firmware update is interrupted or canceled for any reason, the 1Count5V will no longer function correctly as a result. Restart the firmware update and wait until it has completed successfully.

Identification Data ¹

- Hardware release status
- Firmware release status
- Serial number

¹See also ET 200S Distributed I/O operating instructions (<http://support.automation.siemens.com/WW/view/en/1144348>), "Identification data" section.

3.2 Isochronous mode

Note

For basic information on isochronous mode, refer to the Isochronous mode (<http://support.automation.siemens.com/WW/view/en/15218045>) function manual.

Hardware Requirements

You will require the following for the 1Count5V in isochronous mode:

- A CPU that supports isochronous mode
- PROFIBUS master or PROFINET controller that supports the constant bus cycle time
- An IM 151 that supports isochronous mode

Features

Depending on the system parameter assignment, the 1Count5V/500kHz works in either non-isochronous or isochronous mode.

In isochronous mode, data communication between the master and 1Count5V is isochronous to the bus cycle (PROFIBUS DP/PROFINET).

In isochronous mode, all 8 bytes / 12 bytes of the feedback interface are consistent.

If a parameter assignment error occurs, the 1Count5V does not go into isochronous mode.

If isochronous mode fails due to faults or failure/delay of global control (GC), the 1Count5V returns to isochronous mode during the next cycle without an error response.

If isochronous mode fails, the feedback interface is not updated.

The T_i/T_o overlap is supported by the module in firmware version V1.0.1 and later.

See also

Synchronization (Page 143)

3.3 Brief instructions on commissioning the 1Count5V

Task

These instructions guide you to a functioning application that will enable you to count the pulses of an encoder and become familiar with and check the basic hardware and software functions of your 1Count5V. The counting mode used in this example is "Count continuously".

Requirements

The following requirements must be satisfied:

- You must have put an ET 200S station on an S7 station with a DP master into operation.
- You must have the following:
 - A terminal module (e. g. TM-E30S44-01)
 - A 1Count5V,
 - A 5 V encoder with a 24 V encoder supply and the material required for wiring

Installation, Wiring and Fitting

1. Install and wire the TM-E30S44-01 terminal module (see Figure).
2. Plug the 1Count5V into the terminal module. Detailed instructions are provided in the ET 200S Distributed I/O Device (<http://support.automation.siemens.com/WW/view/en/1144348>) operating instructions.

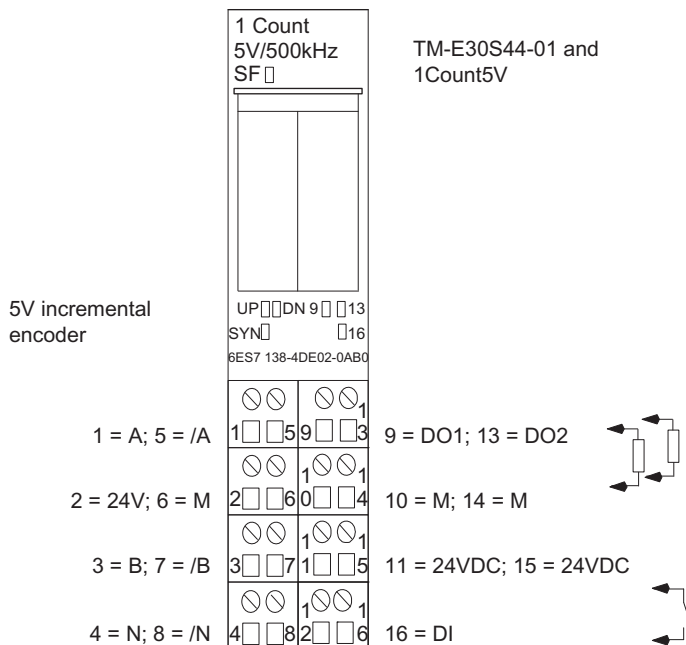

Figure 3-1 Terminal Assignment for the Example

Configuring with STEP 7 using HW Config

You must first adapt the hardware configuration of your existing ET 200S station.

1. Open the relevant project in SIMATIC Manager.
2. Open the HW Config configuration table in your project.
3. Select 1Count5V in the hardware catalog. The number 6ES7 138-4DE02-0AB0 C appears in the infotext.
4. Drag the entry to the slot at which you have mounted your 1Count5V.
5. Double-click this number to open the 1Count5V C (R-S Slot Number) tab.

On the Addresses tab, you will find the addresses of the slot to which you have dragged the 1Count5V. Make a note of these addresses for subsequent programming.

The Parameters tab contains the default settings for the 1Count5V. Leave the default settings unchanged.

6. Save and compile your configuration, and download the configuration in STOP mode of the CPU by choosing "PLC > Download to Module".

Integration into the User Program (Not for Modified User Data Interface)

Create block FC 101 and integrate it in your control program (in OB 1, for example). This block requires the DB1 data block with a length of 16 bytes. The start address of the module in the following example is 256.

STL	Description
Block: FC101	
Network 1: Presettings	
L 0	//Delete control bits
T DB1.DBDO	
T DB1.DBD4	
SET	
S DB1.DBX4.0	//Open SW gate
Network 2: Write to the control interface	
L DB1.DBDO	//Write 6 bytes to the 1Count5V
T PAD 256	//Configured start address of the outputs
L DB1.DBW4	
T PAW 260	

STL	Description
Network 3: Read from the feedback interface	
	//Read 8 bytes from the 1Count5V
L PED 256	//Configured start address of the inputs
T DB1.DB8	
L PED 260	
T DB1.DB12	

Testing

Use "Monitor/Modify Variables" to monitor the count value and the gate.

1. Select the "Block" folder in your project. Choose the "Insert > S7 Block > Variable Table" menu command to insert the VAT 1 variable table, and then confirm with OK.
2. Open the VAT 1 variable table, and enter the following variables in the "Address" column:
 - DB1.DB8 (current count value)
 - DB1.DBx13.0 (internal gate status)
3. Choose "PLC > Connect To > Configured CPU" to switch to online.
4. Choose "Variable > Monitor" to switch to monitoring.
5. Switch the CPU to RUN mode.
 - The "internal gate status" bit must be set.
6. Use your encoder to generate pulses.

Result

You can now see that:

- The UP LED on the 1Count5V is on. The status of the UP LED changes with each new pulse.
- The count value in the block changes.

3.4 Terminal Assignment Diagram

Wiring Rules

The cables (terminals 1 and 8 and terminals 15 and 16) must be shielded. The shield must be supported at both ends. To do this, use the shield contact (see the ET 200S Distributed I/O System (<http://support.automation.siemens.com/WW/view/en/1144348>) operating instructions).

Table 3- 1 Terminal assignment of the 1Count5V

View	Terminal Assignment	Remarks
<p>5V incremental encoder</p> <p>UP DN 9 13 SYN 16 6ES7 138-4DE02-0AB0</p> <p>1 = A; 5 = /A 2 = 24V; 6 = M 3 = B; 7 = /B 4 = N; 8 = /N</p> <p>9 = DO1; 13 = DO2 10 = M; 14 = M 11 = 24VDC; 15 = 24VDC 16 = DI</p>	<p>TM-E30S44-01 and 1Count5V</p>	<p>A, /A: Track A B, /B: Track B N, /N: Track N 24 VDC: Sensor supply M: Chassis ground DI: Digital input DO1: Digital output DO2: Digital output</p>

3.5 Operating modes and application areas of the 1Count5V

Introduction

To begin with, decide how you want to use the 1Count5V. You can choose from the following operating modes:

Counting modes	Measuring modes	Position feedback	Fast mode
Count continuously	Frequency measurement	Position detection	Position feedback in short (isochronous) cycles
Count once	Rotational speed measurement		
Count periodically	Period measurement		

Parameters are assigned to the various modes. You will find the parameter lists in the descriptions of the modes. You can integrate the 1Count5V in your project in two different ways. Decide whether you want to work with a GSD file or with STEP 7.

Integrate 1Count5V using STEP 7

Integrate the 1Count5V with STEP 7 (in isochronous and non-isochronous mode)			
Select an entry from the hardware catalog that corresponds to the operating mode you want.			
For counting modes, select the "1Count5V Counting Mode V2.0" entry	For measuring modes, select the "1Count5V Measuring Mode V2.0" entry	For position detection, select the "1Count5V Position Detection V2.0" entry	For fast mode, select the "1COUNT5V Fast Mode V2.0" entry
The number 6ES7 138-4DE02-0AB0 C appears in the infotext. Drag the entry to the slot at which you have mounted your 1Count5V.	The number 6ES7 138-4DE02-0AB0 M appears in the infotext. Drag the entry to the slot at which you have mounted your 1Count5V.	The number 6ES7 138-4DE02-0AB0 W appears in the infotext. Drag the entry to the slot at which you have mounted your 1Count5V.	The number 6ES7 138-4DE02-0AB0 F appears in the infotext. Drag the entry to the slot at which you have mounted your 1Count5V.
Select the parameters.			

Integrate the 1Count5V with the GSD file

Integrate 1Count5V with the GSD file (only in non-isochronous mode)		
Select an entry in the GSD file that corresponds to the operating mode you want.		
Select the entry C 6ES7 138-4DE02-0AB0 1CNT5V for counting modes	Select the entry M 6ES7 138-4DE02-0AB0 1CNT5V for measuring modes	Select the entry W 6ES7 138-4DE02-0AB0 1CNT5V for position feedback
Select the parameters.		

Note

Fast mode is designed for use in especially short isochronous cycles. You need STEP 7 to configure isochronous operation.

3.6 Count Modes

3.6.1 Overview

Introduction

The counting modes are used in counting applications (for counting of items, for example). For the "Counting Mode" parameter, you can select from the following modes:

- Count continuously (for position detection with incremental encoders, for example)
- Count once (for counting items up to a maximum limit, for example)
- Count periodically (in applications with recurring counting operations, for example)

To run one of these modes, you have to assign parameters to the 1Count5V (see section "Parameter Assignment for the Count Modes (Page 163)").

Maximum Count Range

The high counting limit is +2147483647 ($2^{31} - 1$).

The low counting limit is -2147483648 (-2^{31}).

Load Value

You can specify a count value through a load value for the 1Count5V.

This load value is either applied directly as the new count value (LOAD_VAL) or it is applied as the count value when one of the following events occurs (LOAD_PREPARE):

- **In the Count once and Count periodically counting modes**
 - The low or high counting limit is reached when a main count direction is not assigned.
 - The assigned high counting limit is reached when the main count direction is up.
 - Zero is reached when the main count direction is down.
- **In all counting modes**
 - The counting operation is started by a SW gate or HW gate (if the counting operation is continued, the load value is not applied).
 - Synchronization
 - Latch and retrigger

Gate Control

To control the 1Count5V, you have to use the gate functions.

Main Count Direction

With the main count direction, you assign which RESET states (status following parameter assignment) the load value and count value can take on. It is thus possible to create incrementing or decrementing count applications. The assigned main count direction has no effect on the direction evaluation when the count pulses are detected.

RESET States of the Following Values after Parameter Assignment

Table 3-2 RESET States

Value	Main count direction	RESET state
Load value	None	0
	Up	0
	Down	Assigned high counting limit
Count value	None	0
	Up	0
	Down	Assigned high counting limit
Comparison value 1 and 2	None	0
	Up	0
	Down	Assigned high counting limit
Latch value	None	0
	Up	0
	Down	Assigned high counting limit

Isochronous Mode

In isochronous mode, the 1Count5V accepts control bits and control values from the control interface in each bus cycle and reports back the response in the same cycle.

In each cycle, the 1Count5V transfers the count or latch value that was valid at time T_i and the status bits valid at time T_i .

A count controlled by hardware input signals can only be transferred in the same cycle if the input signal occurred before time T_i .

(See Isochronous Mode (<http://support.automation.siemens.com/WW/view/en/15218045>) function manual)

3.6.2 Endless Counting

Definition

In this mode, the 1Count5V counts continuously starting from the load value:

- If the 1Count5V reaches the high count limit when counting up, and another count pulse then comes, it will jump to the low count limit and continue counting from there without losing a pulse.
- If the 1Count5V reaches the low count limit when counting down, and another count pulse then comes, it will jump to the high count limit and continue counting from there without losing a pulse.
- The high counting limit is set to $+2147483647$ ($2^{31} - 1$).
- The low counting limit is set to -2147483648 (-2^{31}).

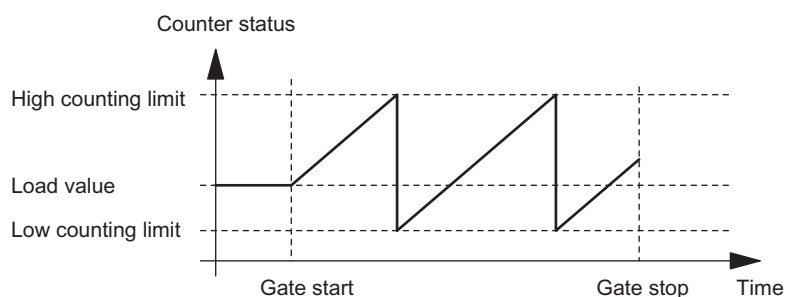

Figure 3-2 Count Continuously with Gate Function

Function of the Digital Input

For the "Function DI" parameter, select one of the following functions for the digital input:

- Input
- HW gate (see section "Gate Functions in Count Modes (Page 139)")
- Latch function (see section "Latch Function (Page 141)")
- Synchronization (see section "Synchronization (Page 143)")

Function of the Digital Outputs

For the "Function DO1" and "Function DO2" parameters, select one of the following functions for each digital output.

- Output, no switching through comparator
- Activation at a counter status greater than or equal to the comparison value
- Activation at a counter status less than or equal to the comparison value
- Pulse on reaching the comparison value
- Switch at comparison values (DO1 only)

(see section "Behavior of the Outputs in Count Modes (Page 147)")

Influencing the Behavior of the Digital Outputs via

- Hysteresis
- Pulse duration

(see section "Behavior of the Outputs in Count Modes (Page 147)")

Values that Can Be Changed During Operation

- Load value (LOAD_PREPARE)
- Counter status (LOAD_VAL)
- Comparison value 1 (CMP_VAL1)
- Comparison value 2 (CMP_VAL2)
- Function and behavior of the digital outputs (C_DOPARAM)

(see sections "Behavior of the Outputs in Count Modes (Page 147)" and "Assignment of the Feedback and Control Interface for the Count Modes (Page 155)")

3.6.3 Once-Only Counting

Definition

In this mode, the 1Count5V counts once only, depending on the assigned main count direction ("Main count direction" parameter).

- When there is no main count direction:
 - Counts starting from the load value.
 - Counts up or down.
 - The count limits are fixed at the maximum count range.
 - If the high or low counting limit is violated, the gate is closed automatically, and the counter jumps to the respective counting limit.
- When the main count direction is up:
 - Counts starting from the load value.
 - Counts up or down.
 - When the high count limit is reached, the counter jumps to the load value and the gate is closed.
 - The high count limit can be assigned parameters, and the load value has RESET state of 0 and can be changed.
- When the count direction is down:
 - Counts starting from the load value.
 - Counts up or down.
 - When the low counting limit is reached, the 1Count5V jumps to the load value and the gate is closed.
 - The low count limit is fixed at 0, and the load value can be assigned parameters (parameter: high count limit) and can be changed.

The internal gate is automatically closed in the event of an overflow/underflow at the count limits. To restart counting, you have to open the gate again.

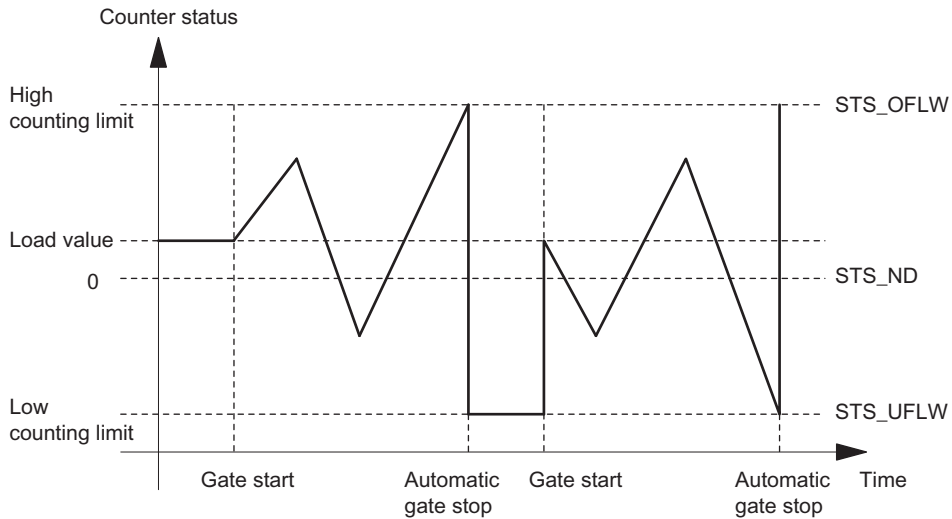

Figure 3-3 Count Once Without Main Count Direction; Canceling Gate Function

With an interrupting gate function, the counter status remains at the underflow when the gate is started.

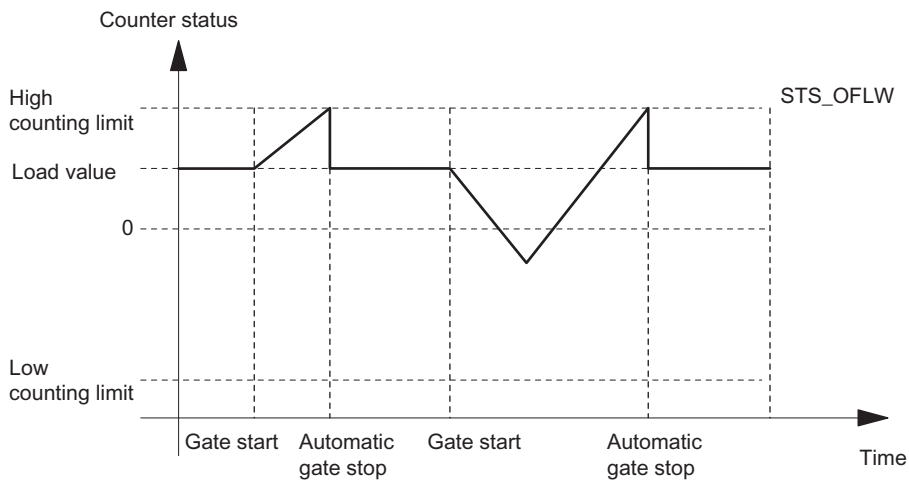

Figure 3-4 Count Once with Up as the Main Count Direction

Function of the Digital Input

For the "Function DI" parameter, select one of the following functions for the digital input:

- Input
- HW gate (see section "Gate Functions in Count Modes (Page 139)")
- Latch function (see section "Latch Function (Page 141)")
- Synchronization (see section "Synchronization (Page 143)")

Function of the Digital Outputs

For the "Function DO1" and "Function DO2" parameters, select one of the following functions for each digital output.

- Output, no switching through comparator
- Activation at a counter status greater than or equal to the comparison value
- Activation at a counter status less than or equal to the comparison value
- Pulse on reaching the comparison value
- Switch at comparison values (DO1 only)

(see section "Behavior of the Outputs in Count Modes (Page 147)")

Influencing the Behavior of the Digital Outputs via

- Hysteresis
- Pulse duration

(see section "Behavior of the Outputs in Count Modes (Page 147)")

Values that Can Be Changed During Operation

- Load value (LOAD_PREPARE)
- Counter status (LOAD_VAL)
- Comparison value 1 (CMP_VAL1)
- Comparison value 2 (CMP_VAL2)
- Function and behavior of the digital outputs (C_DOPARAM)

(see sections "Behavior of the Outputs in Count Modes (Page 147)" and "Assignment of the Feedback and Control Interface for the Count Modes (Page 155)")

3.6.4 Periodic Counting

Definition

In this mode, the 1Count5V counts periodically, depending on the assigned main count direction ("Main count direction" parameter).

- When there is no main count direction:
 - Counts starting from the load value.
 - Counts up or down.
 - The count limits are fixed at the maximum count range.
 - In the event of an overflow or underflow at the respective count limit, the 1Count5V jumps to the load value and continues counting from there.
- When the main count direction is up:
 - Counts starting from the load value.
 - Counts up or down.
 - The high limit can be assigned parameters, and the load value has a RESET status of 0 and can be changed.
 - When the high count limit is reached, the 1Count5V jumps to the load value and continues counting from there.
- When the count direction is down:
 - Counts starting from the load value.
 - Counts up or down.
 - When the low count limit is reached, the 1Count5V jumps to the load value and continues counting from there.
 - The low count limit is fixed at 0, and the load value can be assigned parameters (parameter: high count limit) and can be changed.

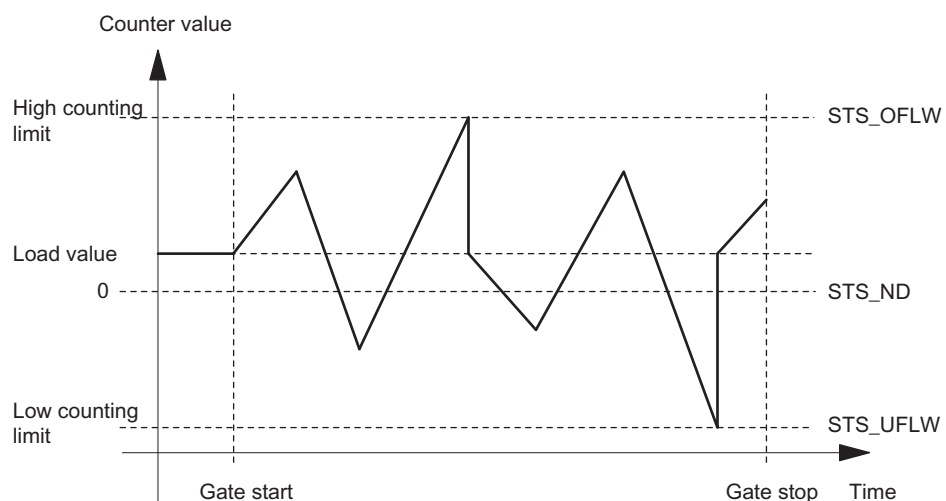

Figure 3-5 Periodic Counting without a Main Count Direction

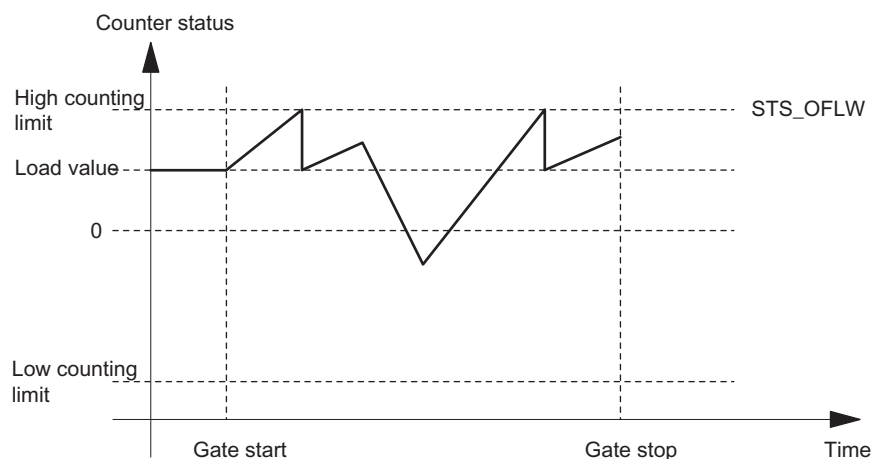

Figure 3-6 Periodic Counting with Up as the Main Count Direction

Function of the Digital Input

For the "Function DI" parameter, select one of the following functions for the digital input:

- Input
- HW gate (see section "Gate Functions in Count Modes (Page 139)")
- Latch function (see section "Latch Function (Page 141)")
- Synchronization (see section "Synchronization (Page 143)")

Function of the Digital Outputs

For the "Function DO1" and "Function DO2" parameters, select one of the following functions for each digital output.

- Output, no switching through comparator
- Activation at a counter status greater than or equal to the comparison value
- Activation at a counter status less than or equal to the comparison value
- Pulse on reaching the comparison value
- Switch at comparison values (DO1 only)

(see section "Behavior of the Outputs in Count Modes (Page 147)")

Influencing the Behavior of the Digital Outputs via

- Hysteresis
- Pulse duration

(see section "Behavior of the Outputs in Count Modes (Page 147)")

Values that Can Be Changed During Operation

- Load value (LOAD_PREPARE)
- Counter status (LOAD_VAL)
- Comparison value 1 (CMP_VAL1)
- Comparison value 2 (CMP_VAL2)
- Function and behavior of the digital outputs (C_DOPARAM)

(see sections "Behavior of the Outputs in Count Modes (Page 147)" and "Assignment of the Feedback and Control Interface for the Count Modes (Page 155)")

3.6.5 Behavior of the Digital Inputs

Digital input of the 1Count5V

The DI digital input can be operated with 24 V sensors (P switch and series mode).

In the case of the input and HW gate functions, the level of the digital input can be inverted by means of "Function DI = Hardware gate" setting with the parameter "Input signal hardware gate" .

The STS_DI feedback bit indicates the level of the digital input.

3.6.6 Gate Functions in Count Modes

Software Gate and Hardware Gate

The 1Count5V has two gates:

- A software gate (SW gate), which is controlled by the SW_GATE control bit.
The software gate can only be opened by a positive edge of the SW_GATE control bit. It is closed when this bit is reset. Note the transfer times and run times of your control program.
- A hardware gate (HW gate), which is controlled by means of the digital input on the 1Count5V. You assign the hardware gate as the function of the digital input (Function DI "HW Gate"). It is opened on a positive edge at the digital input and closed on a negative edge.

Internal gate

The internal gate is the logical AND operation of the HW gate and SW gate. Counting is only active when the HW gate and the SW gate are open. The STS_GATE feedback bit (internal gate status) indicates this. If a HW gate has not been assigned, the setting of the SW gate is decisive. Counting is activated, interrupted, continued, and canceled by means of the internal gate. In the Count once counting mode, the internal gate is closed automatically when there is an overflow/underflow at the counting limits.

Canceling- and Interrupting-Type Gate Function

When assigning the gate function ("Gate Function" parameter), you can specify whether the internal gate is to cancel or interrupt counting. When counting is canceled, after the gate is closed and restarted, counting starts again from the beginning. When counting is interrupted, after the gate is closed and restarted, counting continues from the previous value.

The diagrams below indicate how the interrupting and canceling gate functions work:

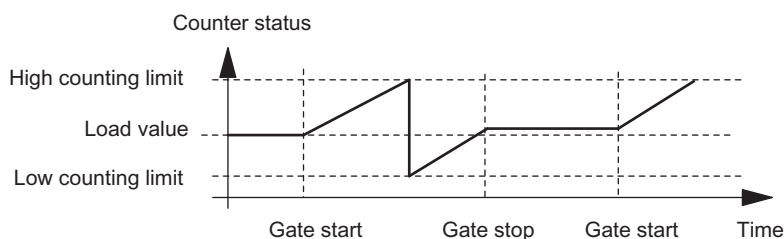

Figure 3-7 Count Continuously, Up, Interrupting Gate Function

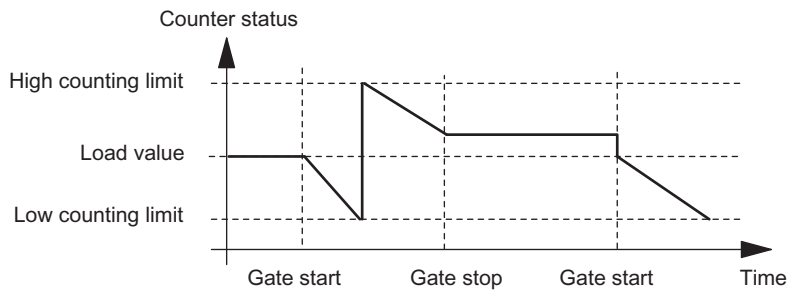

Figure 3-8 Count Continuously, Down, Canceling Gate Function

Gate control by means of the SW gate only

When the gate is opened, one of the following occurs, depending on the parameter assignment:

- Counting continues from the current counter status, or
- Counting starts from the load value

If the SW gate is opened in isochronous mode in bus cycle "n" by setting the SW_GATE control bit, counting starts at time T_o in cycle "n+1". In the same cycle "n+1", the 1Count5V delivers the current count value from time T_i . (See Isochronous Mode (<http://support.automation.siemens.com/WW/view/en/15218045>) function manual)

Gate control by means of the SW gate and HW gate

If the SW gate opens when the HW gate is already open, counting continues starting from the current counter status.

When the HW gate is opened, one of the following occurs, depending on the parameter assignment:

- Counting continues from the current counter status, or
- Counting starts from the load value

If the SW gate is opened in isochronous mode in bus cycle "n" by setting the SW_GATE control bit, counting starts at time T_o in cycle "n+1" if the HW gate is already open at this time. If the HW gate opens between T_o and T_i in cycle "n+1", counting only starts once the HW gate is open. In both cases, the 1Count5V delivers the current count value in cycle "n+1" starting from time T_i .

3.6.7 Latch Function

Introduction

There are two latch functions:

- The Latch and Retrigger function
- The Latch function

The Latch and Retrigger Function

In order to use this function, you must first select it with the "Latch and Retrigger on Positive Edge" Function DI parameter.

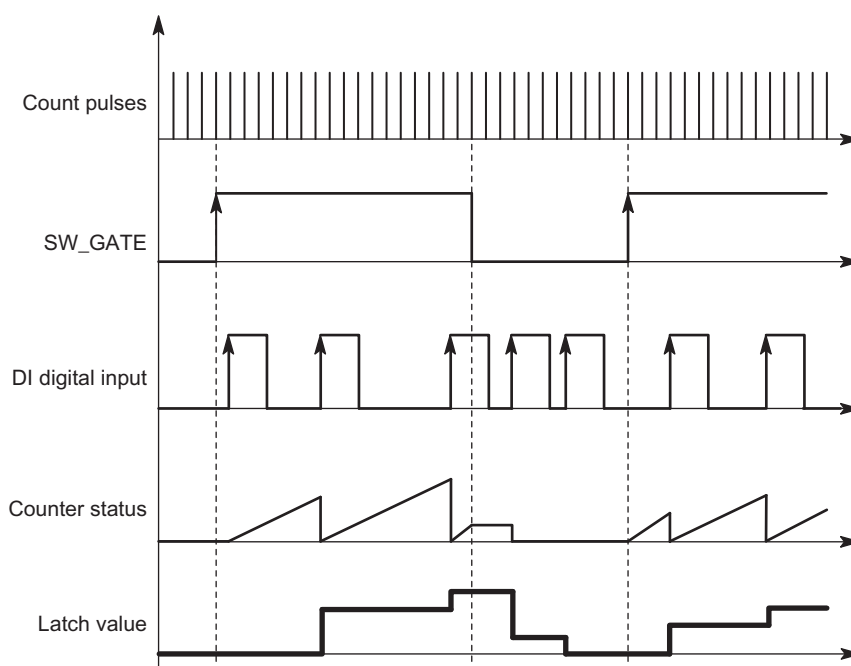

Figure 3-9 Latch and Retrigger with Load Value = 0

This function stores the current internal counter status of the 1Count5V and retriggers counting when there is a positive edge on the digital input.

This means that the current internal counter status at the time of the positive edge is stored (latch value), and the 1Count5V is then loaded again with the load value, from which counting resumes.

The counting mode must be enabled with the SW gate before the function can be executed. It is started with the (first) positive edge on the digital input.

The stored counter status rather than the current counter status is indicated in the feedback interface. The STS_DI bit indicates the level of the latch and retrigger signal.

The latch value is preassigned with its RESET state (see RESET states table). It is not changed when the SW gate is opened.

Direct loading of the counter does not cause the indicated stored counter status to be changed.

If you close the SW gate, counting is only interrupted; this means that when you open the SW gate again, counting is continued. The DI digital input remains active even when the SW gate is closed.

Counting is also latched and triggered in isochronous mode with each edge on the digital input. The counter status that was valid at the time of the last edge before T_i is displayed in the feedback interface.

The Latch Function

In order to use this function, the Function DI parameter must be set to "Latch on Positive Edge".

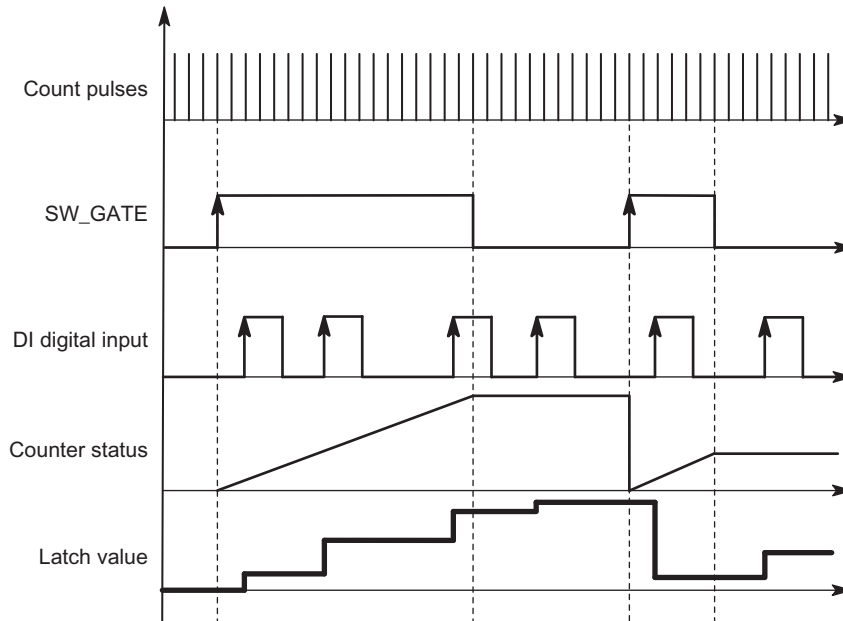

Figure 3-10 Latch with a Load Value of 0

Counter status and latch value are preset with their RESET states (see RESET states table). The counting function is started when the SW gate is opened. The 1Count5V begins at the load value.

The latch value is always the exact counter status at the time of the positive edge on the digital input DI.

The stored counter status rather than the current counter status is indicated in the feedback interface. The STS_DI bit indicates the level of the latch signal.

Direct loading of the counter does not cause the indicated stored counter status to be changed.

In isochronous mode, the counter status that was latched at the time of the last positive edge before T_i is displayed in the feedback interface.

When you close the SW gate, the effect is either canceling or interrupting, depending on the parameter assignment. The digital input DI remains active even when the SW gate is closed.

Expanded Feedback Interface

If the 1Count5V is inserted behind an IM 151 that supports the reading and writing of broader user data interfaces, the current count value can be read from bytes 8 to 11 of the feedback interface.

3.6.8 Synchronization

Introduction

You can synchronize the 1Count5V by two methods:

- Synchronization with DI
- Synchronization with DI and zero mark

Synchronization with DI

In order to use this function, you must first select it with the "Synchronize on Positive Edge" Function DI parameter.

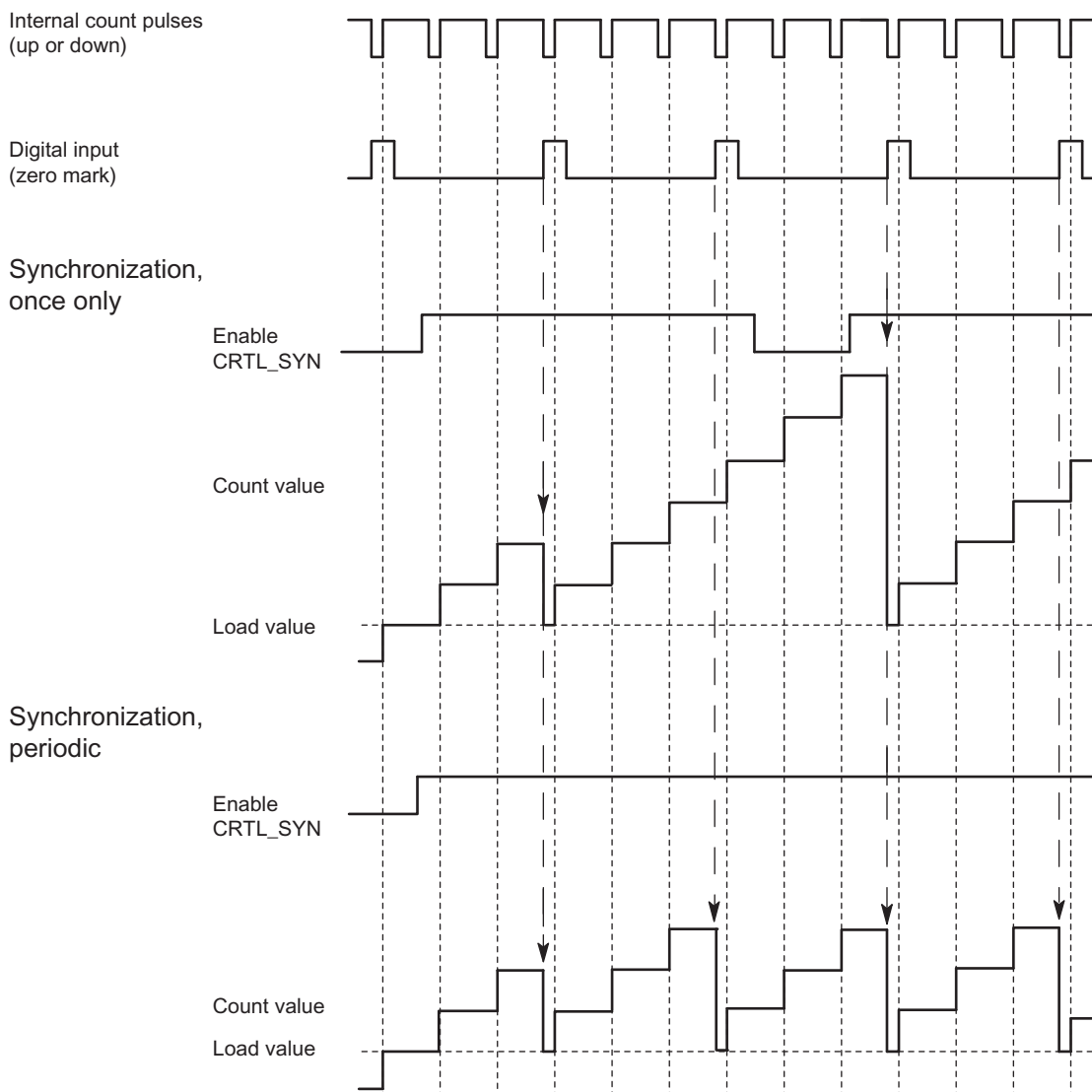

Figure 3-11 Once-Only and Periodic Synchronization

If you have configured synchronization, the positive edge of a reference signal on the input sets the 1Count5V to the load value.

You can select between once-only and periodic synchronization ("Synchronization" parameter).

The following conditions apply:

- The counting mode must have been started with the SW gate.
- The "Enable synchronization CTRL_SYN" control bit must be set.
- Synchronize once only: If the enable bit is set, the first edge loads the 1Count5V with the load value.
- Synchronization periodically: If the enable bit is set, the first and every further edge loads the 1Count5V with the load value.
- After successful synchronization, the STS_SYN feedback bit is set and the SYN LED comes on. The RES_STS control bit resets the feedback bit and switches the LED off.
- The signal of a bounce-free switch can serve as the reference signal.
- The STS_DI feedback bit indicates the level of the reference signal.

In isochronous mode, the set feedback bit STS_SYN indicates that the positive edge on the digital input was between time T_i in the current cycle and T_i in the previous cycle.

Synchronization with DI and Zero Mark

In order to be able to use this function, you must have selected it from the digital input function parameters.

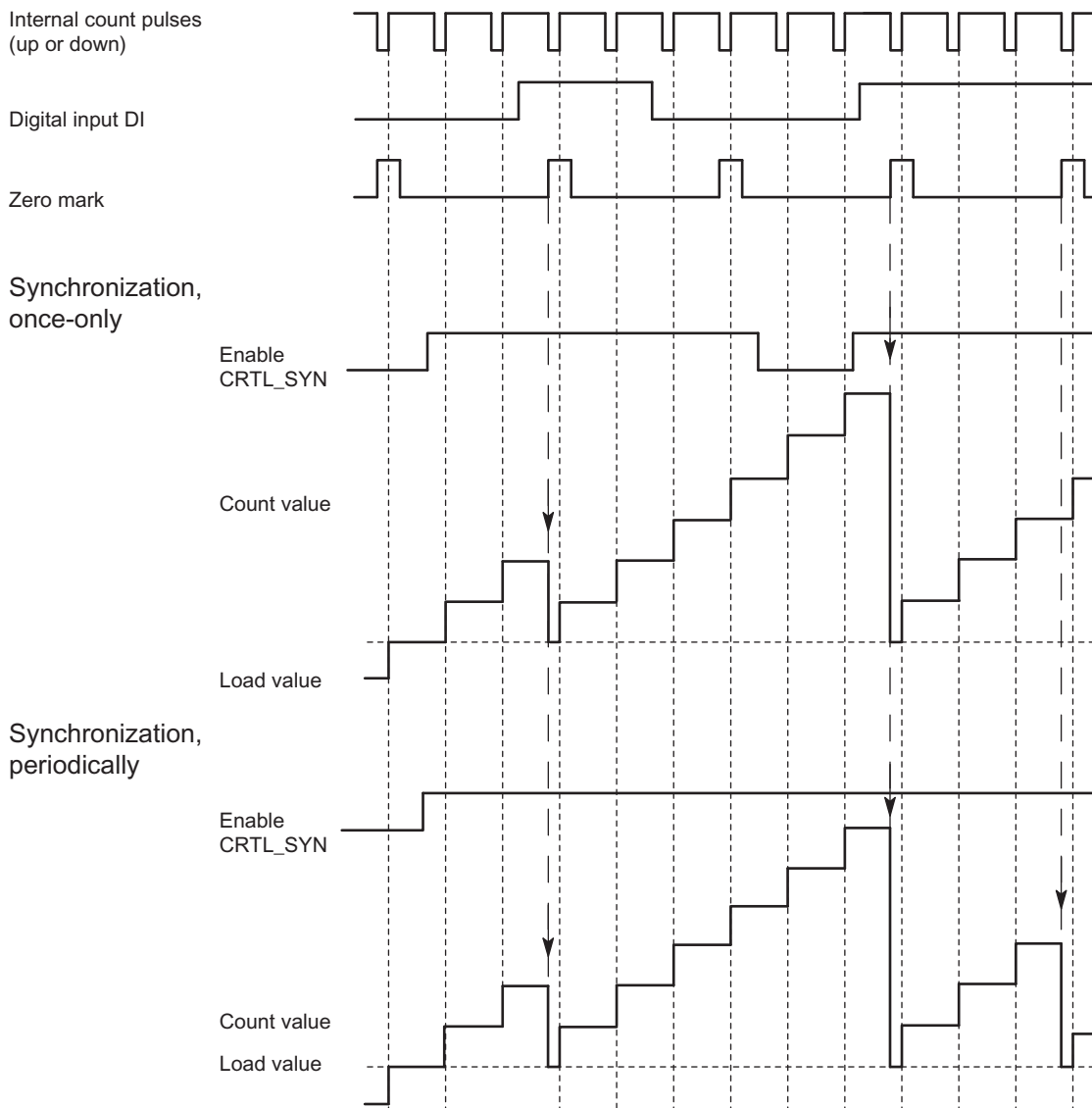

Figure 3-12 Once-Only and Periodic Synchronization

If you have configured synchronization with DI and zero mark, the DI serves as the HW enable. When the HW enable is active, the 1Count5V is loaded with the load value by the zero mark of the encoder.

You can select between once-only and periodic synchronization.

The following conditions apply:

- The counting mode must have been started with the SW gate.
- The "Enable synchronization CTRL_SYN" control bit must be set.

- Synchronize once only: If the enable bit is set and the HW enable is present, the first zero mark loads the 1Count5V with the load value.
- Synchronization periodically: If the enable bit is set and the HW enable is present, the first and every further zero mark loads the 1Count5V with the load value.
- After successful synchronization, the STS_SYN feedback bit is set and the SYN LED comes on. The RES_STS control bit resets the feedback bit and switches the LED off.
- The signal of a bounce-free switch can serve as the reference signal.
- The STS_DI feedback bit indicates the level of the reference signal.

In isochronous mode, the set feedback bit STS_SYN indicates that the positive edge on the digital input was between time T_i in the current cycle and T_i in the previous cycle.

3.6.9 Behavior of the Outputs in Count Modes

Introduction

The 1Count5V allows you to store two comparison values, which are assigned to the digital outputs. The outputs can be activated, depending on the counter status and comparison values. The various ways of setting the behavior of the outputs are described in this section.

Behavior Types of the Digital Outputs

The 1Count5V has two digital outputs.

Parameters can be assigned for both outputs ("Function DO1" and "Function DO2" parameters).

You can change the function and the behavior of the digital outputs during operation.

You can choose from the following functions:

- Output
- Counter status \geq comparison value
- Counter status \leq comparison value
- Pulse on reaching the comparison value
- Switch at comparison values (DO1 only)

Output

You can switch the outputs on and off with the control bits SET_DO1 and SET_DO2.

The control bits CTRL_DO1 or CTRL_DO2 must be set for this.

You can query the status of the outputs with the status bits STS_DO1 and STS_DO2 in the feedback interface.

The status bits STS_CMP1 and STS_CMP2 indicate that the relevant output is or was switched on. These status bits retain their status until they are acknowledged. If the output is still switched, the corresponding bit is set again immediately. These status bits are also set when the control bit SET_DO1 or SET_DO2 is operated without DO1 or DO2 being enabled.

Isynchronous mode: In isochronous mode, the outputs DO1 and DO2 are switched at time T_0 .

Counter Status \leq Comparison Value and Counter Status \geq Comparison Value

If the comparison conditions are fulfilled, the respective comparator switches on the output. The status of the output is indicated by STS_DO1 and STS_DO2.

The control bits CTRL_DO1 or CTRL_DO2 must be set for this.

The comparison result is indicated by the status bits STS_CMP1 or STS_CMP2. You cannot acknowledge and thus reset these bits until the comparison conditions are no longer fulfilled.

Isochronous mode: In isochronous mode as well, the DO1 and DO2 outputs are switched as soon as the comparison condition is fulfilled and are therefore independent of the bus cycle.

Comparison Value Reached, Output Pulse

If the counter status reaches the comparison value, the comparator switches on the respective digital output for the assigned pulse duration.

The control bit CTRL_DO1 or CTRL_DO2 must be set for this.

The status bits STS_DO1 and STS_DO2 always have the status of the corresponding digital output.

The comparison result is indicated by the status bit STS_CMP1 or STS_CMP2 and cannot be reset by acknowledgment until the pulse duration has elapsed.

If a main count direction is assigned, the comparator switches only when the comparison value in the main count direction is reached.

If a main count direction is not assigned, the comparator switches when the comparison value is reached from either direction.

If the digital output is set by control bit SET_DO1 or SET_DO2, it is reset when the pulse duration has elapsed.

Isochronous mode: In isochronous mode as well, the DO1 and DO2 outputs are switched as soon as the comparison condition is fulfilled and are therefore independent of the bus cycle.

Pulse Duration when the Comparison Value is Reached

The pulse duration begins when the respective digital output is set. The inaccuracy of the pulse duration is less than 2 ms.

The pulse duration can be set to suit the actuators used. The pulse duration specifies how long the output is to be set for. The pulse duration can be preselected between 0 ms and 510 ms in increments of 2 ms.

If the pulse duration = 0, the output is set until the comparison condition is no longer fulfilled. Note that the count pulse times must be greater than the minimum switching times of the digital output.

Isochronous mode: In isochronous mode as well, the DO1 and DO2 outputs are switched as soon as the comparison condition is fulfilled and are therefore independent of the bus cycle.

Switch at comparison values

The comparator switches the output when the following conditions are met:

- The two comparison values must be loaded using the load functions CMP_VAL1 and CMP_VAL2, and
- After the comparison values are loaded, the DO1 output must be enabled with CTRL_DO1.

The following table shows you when the DO1 is switched on or off:

	DO1 is switched on when	DO1 is switched off when
V2 < V1 (see Figure below)	$V2 \leq \text{counter status} \leq V1$	$V2 > \text{counter status}$ or $\text{counter status} > V1$
V2 = V1	$V2 = \text{counter status} = V1$	$V2 \neq \text{counter status} \neq V1$
V2 > V1 (see Figure below)	$V1 > \text{counter status}$ or $\text{counter status} > V2$	$V1 \leq \text{counter status} \leq V2$

The comparison result is indicated by the status bit STS_CMP1. You can only acknowledge and thus reset this bit when the comparison condition is no longer fulfilled.

There is no hysteresis in the case of this output behavior.

It is not possible to control the DO1 output with the SET_DO1 control bit in the case of this output behavior.

Isochronous mode: In isochronous mode, as well, the DO1 output is switched as soon as the comparison condition is fulfilled and is therefore independent of the bus cycle.

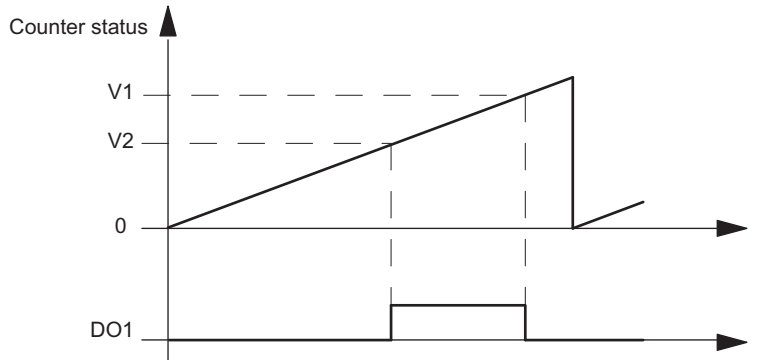

Figure 3-13 $V2 < V1$ at the Start of Counting

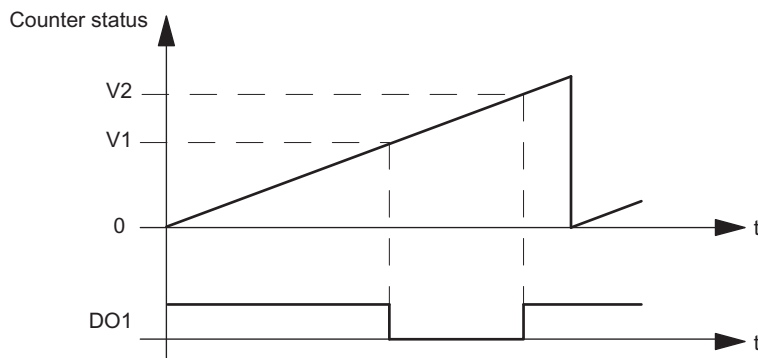

Figure 3-14 $V2 > V1$ at the Start of Counting

Setting or Modifying the Function and Behavior of the Digital Output DO1

When setting or modifying the behavior of DO1, you must take all assignable interdependencies into account. Failure to do so will generate a parameter assignment error or a loading error.

Boundary conditions:

If you assign "Switch at Comparison Values" for DO1, you must:

- Set hysteresis = 0, and
- Assign "Output" for the DO2 output

Hysteresis

An encoder can remain at a particular position and then fluctuate around this position. This state causes the counter status to fluctuate around a particular value. If there is a comparison value in this fluctuation range, for example, the associated output is switched on and off in accordance with the rhythm of the fluctuations. The 1Count5V is equipped with programmable hysteresis to prevent this switching in response to small fluctuations. You can assign a range between 0 and 255 (0 means: hysteresis switched off).

Hysteresis also works with overflow and underflow.

Method of Operation with Counter Status \leq Comparison Value and Counter Status \geq Comparison Value

The diagram below provides an example of how hysteresis works. The figure shows the various responses of an output with a hysteresis of 0 (= switched off) as opposed to hysteresis of 3. In the example, the comparison value is 5.

The following settings are assigned for the counter: "Main count direction" = "Up" and "Switch on at counter status \geq comparison value".

When the comparison condition is met, hysteresis becomes active. While the hysteresis is active, the comparison result remains unchanged.

If the count value goes outside the hysteresis range, hysteresis is no longer active. The comparator switches again according to its comparison conditions.

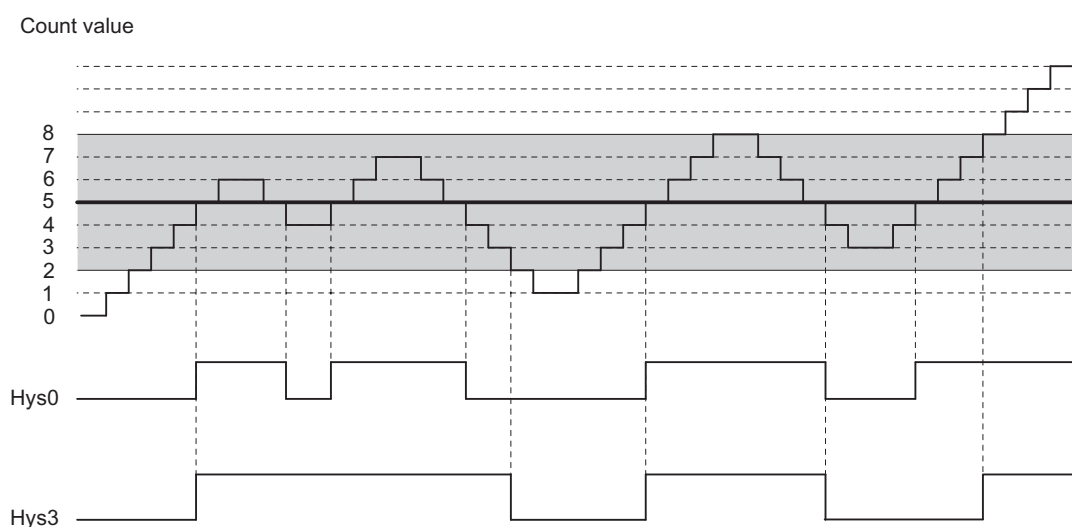

Figure 3-15 Example of How Hysteresis Works

Note

If the count direction changes on the comparison value when hysteresis is active, the output is reset.

Method of Operation when the Comparison Value Is Reached and the Pulse Duration = 0

The diagram below provides an example of how hysteresis works. The figure shows the differences in the behavior of an output when hysteresis of 0 (= switched off) is assigned as opposed to hysteresis of 3. In the example, the comparison value is 5.

The following settings are assigned for the counter: "Pulse on reaching the comparison value", "No main count direction" and "Pulse duration = 0".

When the comparison conditions are met, hysteresis becomes active. While the hysteresis is active, the comparison result remains unchanged. If the count value goes outside the hysteresis range, hysteresis is no longer active. The comparator deletes the result of the comparison.

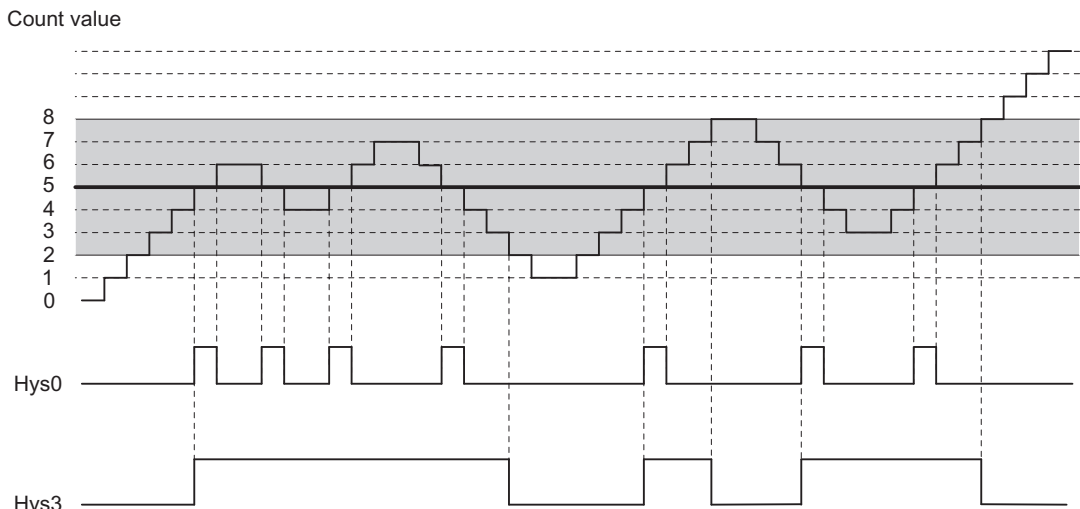

Figure 3-16 Example of How Hysteresis Works

Method of Operation when the Comparison Value Is Reached, Output Pulse Duration

The diagram below provides an example of how hysteresis works. The figure shows the various responses of an output with a hysteresis of 0 (= switched off) as opposed to hysteresis of 3. In the example, the comparison value is 5.

The following settings are assigned for the counter: "Pulse on reaching the comparison value", "No main count direction" and "pulse duration > 0".

When the comparison conditions have been met, hysteresis becomes active and a pulse of the assigned duration is output.

If the count value goes outside the hysteresis range, hysteresis is no longer active.

When hysteresis is enabled, the 1Count5V stores the count direction. If the hysteresis range is exited in a different direction to the one stored, a pulse is output.

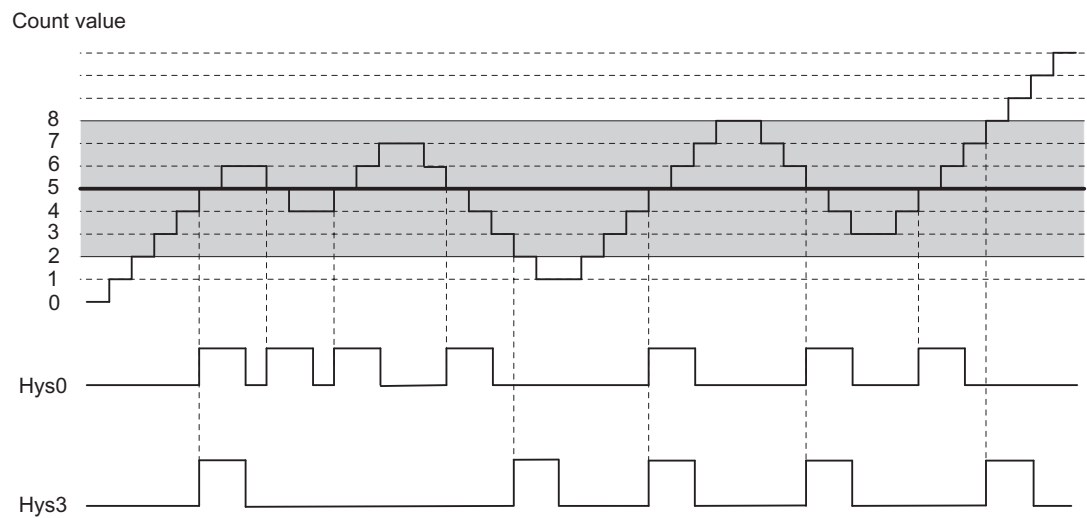

Figure 3-17 Example of How Hysteresis Works

Controlling the Outputs Simultaneously with the Comparators

If you have selected a comparison function for the outputs, you can continue to control the outputs with SET_DO1 or SET_DO2. This allows you to simulate the effect of the comparison functions on your control program:

- The output is set with the positive edge of SET_DO1 or SET_DO2. However, if the "Pulse on Reaching the Comparison Value" function is selected, only one pulse with the specified duration is output. When pulse duration = 0, the output can be set with SET_DO1 or SET_DO2, as long as the count value is located on the comparison value or hysteresis is active. The SET_DO1 control bit is not permitted with the "Switch at Comparison Values" output behavior.
- A negative edge of SET_DO1 or SET_DO2 resets the output.

Note that the comparators are still active and can set or reset the output if the comparison result changes.

Note

An output set with SET_DO1 or SET_DO2 is not reset at the comparison value (by the comparator).

Loading Comparison Values

You transfer the comparison values to the 1Count5V. The counting is not affected by this.

Table 3- 3 Valid Range for the Two Comparison Values

Main count direction: None	Main count direction: Up	Main count direction: Down
Low counting limit to high counting limit	-2147483648 to high counting limit -1	1 to 2147483647

Modifying the Function and Behavior of Digital Outputs

You can modify the functions and behavior of the outputs during operation using the control interface. The 1Count5V deletes the outputs and accepts the values as follows:

- Function of digital outputs DO1 and DO2: If you change this function so that the comparison condition is satisfied, the output is not set until after the next count pulse. However, if hysteresis is enabled, the 1Count5V does not make any changes at the output.
- Hysteresis: An active hysteresis (see How Hysteresis Works) continues to be active following the change. The new hysteresis range is applied the next time the comparison value is reached.
- Pulse duration: The new pulse duration takes effect with the next pulse.

3.6.10 Assignment of the Feedback and Control Interface for the Count Modes

Note

For the 1Count5V, the following data of the control and feedback interface are consistent:

Bytes 0 to 3

Bytes 4 to 7

Bytes 8 to 11 (modified user data interface)

Use the access or addressing mode for data consistency over the entire control and feedback interface on your DP master (only for configuration using the GSD file).

Assignment Tables

The tables show the assignment of the feedback and control interface for the counting modes.

Table 3- 4 Feedback Interface (Inputs)

Address	Assignment	Designation
Bytes 0 to 3	Count value or stored count value in the case of the latch function on the digital input	
Byte 4	Bit 7: Short circuit of the encoder supply Bit 6: Short circuit / wire break / overtemperature Bit 5: Parameter assignment error Bit 4: Short circuit / wire break / overtemperature Bit 3: Short circuit / wire break / encoder signal Bit 2: Resetting of status bits active Bit 1: Load function error Bit 0: Load function is running	ERR_24V ERR_DO1 ERR_PARA ERR_DO2 ERR_ENCODER RES_STS_A ERR_LOAD STS_LOAD
Byte 5	Bit 7: Down direction status Bit 6: Up direction status Bit 5: Reserve = 0 Bit 4: DO2 status Bit 3: DO1 status Bit 2: Reserve = 0 Bit 1: DI status Bit 0: Internal gate status	STS_C_DN STS_C_UP STS_DO2 STS_DO1 STS_DI STS_GATE

3.6 Count Modes

Address	Assignment	Designation
Byte 6	Bit 7: Zero-crossing in the count range when counting without a main count direction Bit 6: Low count limit Bit 5: High count limit Bit 4: Comparator 2 status Bit 3: Comparator 1 status Bit 2: Reserve = 0 Bit 1: Reserve = 0 Bit 0: Synchronization status	STS_ND STS_UFLW STS_OFLW STS_CMP2 STS_CMP1 STS_SYN
Byte 7	Reserve = 0	
Bytes 8 to 11	Count value ¹	
¹ Modified user data interface		

Table 3- 5 Control Interface (Outputs)

Address	Assignment																																				
Bytes 0 to 3	Load value direct, preparatory, comparison value 1 or 2																																				
	Behavior of DO1, DO2 of the 1Count5V																																				
	<table border="1"> <thead> <tr> <th>Bit 2</th> <th>Bit 1</th> <th>Bit 0</th> <th>Function DO1</th> </tr> </thead> <tbody> <tr> <td>0</td> <td>0</td> <td>0</td> <td>Output</td> </tr> <tr> <td>0</td> <td>0</td> <td>1</td> <td>Switch on at counter status \geq comparison value</td> </tr> <tr> <td>0</td> <td>1</td> <td>0</td> <td>Switch on at counter status \leq comparison value</td> </tr> <tr> <td>0</td> <td>1</td> <td>1</td> <td>Pulse on reaching the comparison value</td> </tr> <tr> <td>1</td> <td>0</td> <td>0</td> <td>Switch at comparison values</td> </tr> <tr> <td>1</td> <td>0</td> <td>1</td> <td>blocked</td> </tr> <tr> <td>1</td> <td>1</td> <td>0</td> <td>blocked</td> </tr> <tr> <td>1</td> <td>1</td> <td>1</td> <td>blocked</td> </tr> </tbody> </table>	Bit 2	Bit 1	Bit 0	Function DO1	0	0	0	Output	0	0	1	Switch on at counter status \geq comparison value	0	1	0	Switch on at counter status \leq comparison value	0	1	1	Pulse on reaching the comparison value	1	0	0	Switch at comparison values	1	0	1	blocked	1	1	0	blocked	1	1	1	blocked
	Bit 2	Bit 1	Bit 0	Function DO1																																	
	0	0	0	Output																																	
	0	0	1	Switch on at counter status \geq comparison value																																	
	0	1	0	Switch on at counter status \leq comparison value																																	
	0	1	1	Pulse on reaching the comparison value																																	
	1	0	0	Switch at comparison values																																	
	1	0	1	blocked																																	
1	1	0	blocked																																		
1	1	1	blocked																																		
<table border="1"> <thead> <tr> <th>Bit 5</th> <th>Bit 4</th> <th>Function DO2</th> </tr> </thead> <tbody> <tr> <td>0</td> <td>0</td> <td>Output</td> </tr> <tr> <td>0</td> <td>1</td> <td>Switch on at counter status \geq comparison value</td> </tr> <tr> <td>1</td> <td>0</td> <td>Switch on at counter status \leq comparison value</td> </tr> <tr> <td>1</td> <td>1</td> <td>Pulse on reaching the comparison value</td> </tr> </tbody> </table>	Bit 5	Bit 4	Function DO2	0	0	Output	0	1	Switch on at counter status \geq comparison value	1	0	Switch on at counter status \leq comparison value	1	1	Pulse on reaching the comparison value																						
Bit 5	Bit 4	Function DO2																																			
0	0	Output																																			
0	1	Switch on at counter status \geq comparison value																																			
1	0	Switch on at counter status \leq comparison value																																			
1	1	Pulse on reaching the comparison value																																			
Bits 3, 6, and 7: Reserve = 0																																					
Bytes 1 to 3	Byte 1: Hysteresis DO1, DO2 (range 0 to 255) Byte 2: Pulse duration [2ms] DO1, DO2 (range 0 to 255) Byte 3: Reserve = 0																																				

Address		Assignment
Byte 4	EXTF_ACK CTRL_DO2 SET_DO2 CTRL_DO1 SET_DO1 RES_STS CTRL_SYN SW_GATE	Bit 7: Error diagnostics acknowledgment Bit 6: Enable DO2 Bit 5: Control bit DO2 Bit 4: Enable DO1 Bit 3: Control bit DO1 Bit 2: Start resetting of status bit Bit 1: Enable synchronization Bit 0: SW gate control bit
Byte 5	C_DOPARAM CMP_VAL2 CMP_VAL1 LOAD_PREPARE LOAD_VAL	Bit 7: Reserve = 0 Bit 6: Reserve = 0 Bit 5: Reserve = 0 Bit 4: Change function and behavior of DO1, DO2 Bit 3: Load comparison value 2 Bit 2: Load comparison value 1 Bit 1: Load counter preparatory Bit 0: Load counter direct
Bytes 6 to 7		Reserve = 0 ¹
¹ Not used for modified user interface		

Notes on the Control Bits

Table 3- 6 Notes on the Control Bits

Control bits	Notes
C_DOPARAM	Change function and behavior of DO1, DO2 The values from bytes 0 to 2 are applied as new function, hysteresis, and pulse duration of DO1, DO2. This may result in the following error: The conditions for the "Switch at comparison values" behavior are not fulfilled.
CMP_VAL1	Load comparison value 1 The value from bytes 0 to 3 is transferred to comparison value 1 with the control bit "Load comparison value CMP_VAL1".
CMP_VAL2	Load comparison value 2 The value from bytes 0 to 3 is transferred to comparison value 2 with the control bit "Load comparison value CMP_VAL2".
CTRL_DO1	Enable DO1 You use this bit to enable the DO1 output.
CTRL_DO2	Enable DO2 You use this bit to enable the DO2 output.
CTRL_SYN	You use this bit to enable synchronization.
EXTF_ACK	Error acknowledgment The error bits must be acknowledged with the EXTF_ACK control bit after the cause is removed.
LOAD_PREPARE	Load counter preparatory The value from bytes 0 to 3 is applied as the load value.
LOAD_VAL	The value from bytes 0 to 3 is loaded directly as the new count value.

3.6 Count Modes

Control bits	Notes
RES_STS	Start resetting of status bit The status bits are reset by means of the acknowledgment process between the RES_STS bit and the RES_STS_A bit.
SET_DO1	Control bit DO1 Switches the DO1 digital output on and off when CTRL_DO1 is set.
SET_DO2	Control bit DO2 Switches the DO2 digital output on and off when CTRL_DO2 is set.
SW_GATE	SW gate control bit The SW gate is opened/closed via the control interface with the SW_GATE bit.

Notes on the Feedback Bits

Table 3- 7 Notes on the Feedback Bits

Feedback bits	Notes
ERR_24V	Short circuit of the encoder supply The error bit must be acknowledged by the EXTF_ACK control bit. Diagnostic message, if assigned.
ERR_DO1	Short circuit/wire break/overtemperature due to overload at output DO1 The error bit must be acknowledged by the EXTF_ACK control bit. Diagnostic message, if assigned.
ERR_DO2	Short circuit/wire break/overtemperature at output DO2 The error bit must be acknowledged by the EXTF_ACK control bit. Diagnostic message, if assigned.
ERR_ENCODER	Short circuit / wire break of 5 V encoder signal The error bit must be acknowledged by the EXTF_ACK control bit. Diagnostic message, if assigned.
ERR_LOAD	Load function error The LOAD_VAL, LOAD_PREPARE, CMP_VAL1, CMP_VAL2, and C_DOPARAM bits cannot be set simultaneously during transfer. This results in setting the ERR_LOAD status bit, similar to loading an incorrect value (which is not accepted).
ERR_PARA	Parameter assignment error ERR_PARA
RES_STS_A	Resetting of status bits active
STS_C_DN	Down direction status
STS_C_UP	Up direction status
STS_CMP1	Comparator 1 status The STS_CMP1 status bit indicates that the output is or was switched on. It must be acknowledged with the RES_STS control bit. If the status bit is acknowledged when the output is still switched on, the bit is set again immediately. This bit is also set if the SET_DO1 control bit is used when DO1 is not enabled.
STS_CMP2	Comparator 2 status The STS_CMP2 status bit indicates that the output is or was switched on. It must be acknowledged with the RES_STS control bit. If the status bit is acknowledged when the output is still switched on, the bit is set again immediately. This bit is also set if the SET_DO2 control bit is used when DO2 is not enabled.

Feedback bits	Notes
STS_DI	DI status The status of the DI is indicated in all modes with the STS_DI bit in the feedback interface.
STS_DO1	DO1 status The STS_DO1 status bit indicates the status of the DO1 digital output.
STS_DO2	DO2 status The STS_DO2 status bit indicates the status of the DO2 digital output.
STS_GATE	Internal gate status: Counting
STS_LOAD	Load function is running
STS_ND	Zero-crossing in the count range when counting without a main counting direction. The bit must be reset by the RES_STS control bit.
STS_OFLW STS_UFLW	High counting limit violated Low counting limit violated Both bits must be reset.
STS_SYN	Synchronization status After successful synchronization, the STS_SYN bit is set. It must be reset by the RES_STS control bit.

Access to the Control and Feedback Interface in STEP 7 Programming

Table 3- 8 Access to the Control and Feedback Interface in STEP 7 Programming

	Configuring with STEP 7 using the GSD file ¹⁾ (Hardware catalog\PROFIBUS-DP\Additional FIELD DEVICES\OET 200S)	Configuring with STEP 7 using HW Config (Hardware catalog\PROFIBUS-DP\ET 200S)
Feedback interface	Read with SFC 14 "DPRD_DAT"	Load command (e.g. L PID)
Control interface	Write with SFC 15 "DPWR_DAT"	Transfer command (e.g. T PQD)
¹ Load and transfer commands are also possible with CPU 3xxC, CPU 3xx with MMC, and CPU 4xx (V3.0 and later).		

Resetting of the Status Bits

STS_SYN, STS_CMP1, STS_CMP2, STS_OFLW, STS_UFLW, STS_ND

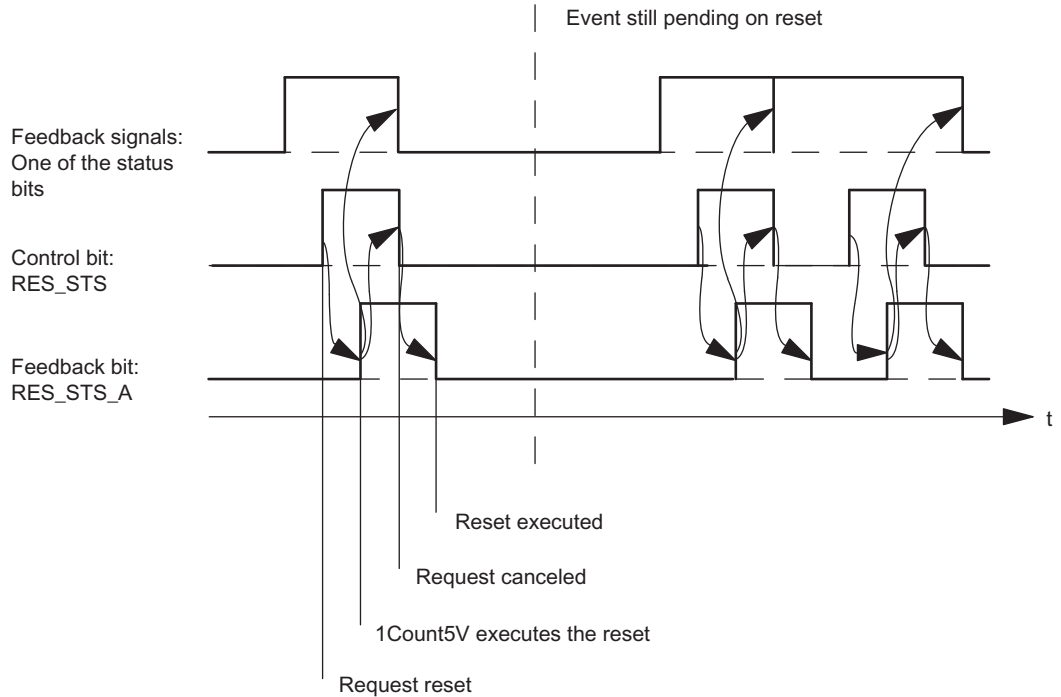

Figure 3-18 Resetting of the Status Bits

Acceptance of Values with the Load Function

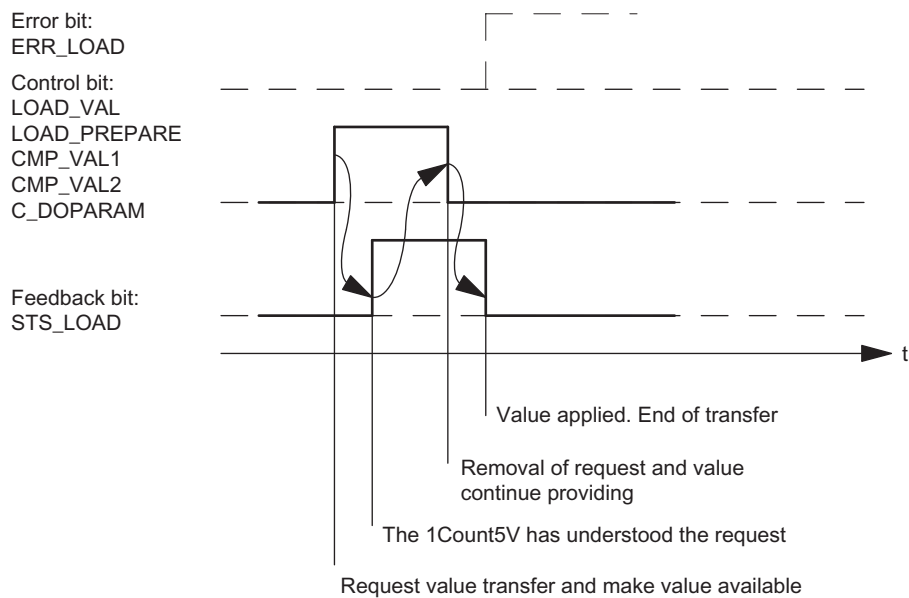

Figure 3-19 Acceptance of Values with the Load Function

Note

Only one of the following control bits can be set at a particular time:

CMP_VAL1 or CMP_VAL2 or LOAD_VAL or LOAD_PREPARE or C_DOPARAM.

Otherwise, the ERR_LOAD error is reported until all the specified control bits are deleted again.

The ERR_LOAD error bit is only deleted when the following is carried out correctly.

Acknowledgment Principle in Isochronous Mode

In isochronous mode, exactly 4 bus cycles are always required to reset the status bits and to accept values during the load function.

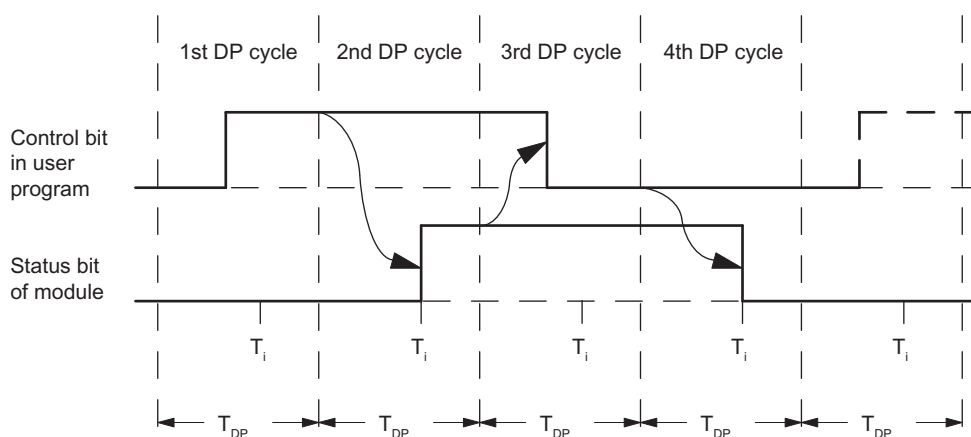

Figure 3-20 Acknowledgment Principle in Isochronous Mode

Error Detection

The program errors must be acknowledged. They have been detected by the 1Count5V and are indicated at the feedback interface.

Channel-specific diagnostics are performed if you have enabled group diagnostics in your configuration (see device manual of the interface module used).

The parameter assignment error bit is acknowledged by means of correct parameter assignment.

An error has occurred, the 1Count5V sets an error bit, a diagnostic message may appear, error detection continues

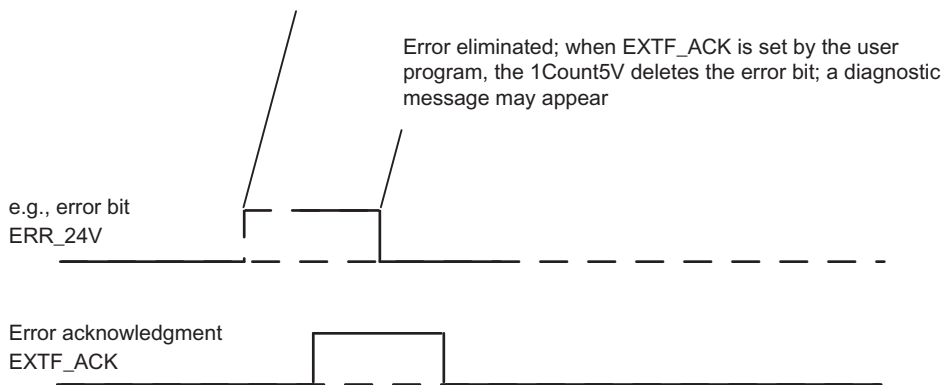

Figure 3-21 Error Acknowledgment

In the case of continuous error acknowledgment (EXTF_ACK=1) or at CPU/Master Stop, the 1Count5V signals errors as soon as they are detected and resets them as soon as they have been eliminated.

3.6.11 Parameter Assignment for the Count Modes

Introduction

You can use either of the following to assign parameters for the 1Count5V:

- STEP 7 V5.3 SP2 or later
- A GSD file (<http://www.automation.siemens.com/csi/gsd>)

Parameter List for Counting Modes

Table 3- 9 Parameter List for Counting Modes

Parameter	Value Range	Default
Enable		
Group diagnostics	Disable/enable	Disable
Response to failure of the higher-level controller		
Response to CPU/master STOP	Turn off DO/ Continue working mode/ DO substitute a value/ DO keep last value	Turn off DO
Encoder parameters		
Signal evaluation A, B	Rotary encoder single/double/quadruple	Rotary encoder single
Diagnostics A and B	Off/on	Off
Diagnostics N	Off/on	Off
Direction input B	Normal/inverted	normal
Output parameters		
Function DO1	Output/ Switch on at counter status \geq comparison value/ Switch on at counter status \leq comparison value/ Pulse on reaching the comparison value/ Switch at comparison values	Output
Function DO2	Output/ Switch on at counter status \geq comparison value/ Switch on at counter status \leq comparison value/ Pulse on reaching the comparison value	Output
Substitute value DO1	0/1	0
Substitute value DO2	0/1	0
Diagnostics DO1 ¹	Off/on	Off
Diagnostics DO2 ¹	Off/on	Off
Hysteresis DO1, DO2	0...255	0
Pulse duration [2 ms] DO1, DO2	0...255	0

Parameter	Value Range	Default
Mode		
Counting mode	Continuous counting/ Once-only counting/ Periodic counting	Count continuously
Gate function	Cancel counting/ Interrupt counting	Cancel counting
Input signal HW gate	Normal/inverted	Normal
Function DI	Input/ HW gate/ Latch and retrigger at positive edge/ Synchronization at positive edge/ Latch at positive edge/ HW enable for synchronization	Input
Synchronization ²	Once only/Periodic	Once-only
Main count direction	None/Up/Down	None
High counting limit	2 ... 7FFF FFFF	7FFF FFFF
¹ DO1/DO2 diagnostics (wire break) is possible only with pulse lengths of > 90 ms on digital output DO1/DO2. ² Only relevant if Function DI = Synchronization at positive edge or HW enable for synchronization		

Parameter Assignment Error

- Incorrect mode
- Incorrect main count direction
- The "Input signal HW gate" parameter is set to inverted and the "Function DI" parameter is not set to HW gate.
- High counting limit incorrect
- The value for the behavior of DO2 is not set to output although "Switch at comparison values" has been assigned for DO1.
- The value for hysteresis does not equal 0 although "Switch at comparison values" has been assigned for DO1.
- Function DI incorrect
- "On" is set for diagnostics N although "Off" was set for diagnostics A and B.

What to Do in the Event of Errors

Check the set value ranges.

3.7 Measurement Modes

3.7.1 Overview

Introduction

For the "Measuring Mode" parameter, you can select from the following modes:

- Frequency Measurement
- Period Measurement
- Rotational Speed Measurement

For the "Measuring Method" parameter, you can select from the measurement methods:

- With integration time
- Continuous

To run one of these modes, you have to assign parameters to the 1Count5V (see section "Parameter Assignment for Measurement Modes (Page 195)").

Sequence of Measurements with Integration Time

The measurement is carried out during the assigned integration time. When the integration time elapses, the measured value is updated.

The end of a measurement is indicated by the STS_CMP1 status bit. This bit is reset by the RES_STS control bit in the control interface.

If there were not at least two positive edges in the integration time which has been assigned parameters, 0 is returned as the measured value.

A value of -1 is returned up until the end of the first integration time.

You can change the integration time for the next measurement during operation.

Direction Reversal

If the direction of rotation is reversed during an integration time, the measured value for this measurement period is uncertain. If you evaluate the STS_C_UP and STS_C_DN feedback bits (direction evaluation), you can respond to any process irregularities.

3.7.2 Sequence of continuous-action measurement

Measuring Principle

The 1Count5V counts each positive edge of a pulse and assigns it a time value in μs .

The update time indicates the time interval at which the measured value is updated by the module in the feedback interface.

Rule for pulse sequences with one or several pulses per update time:

$$\begin{aligned} \text{Dynamic measuring time} = & \text{Time of last pulse in the current update time interval} \\ & \text{minus} \\ & \text{Time of last pulse in the previous update time interval} \end{aligned}$$

When the update time has elapsed, a new measured value is calculated and output with the dynamic measuring time.

If the current update time does not contain a pulse, the following dynamic measuring time results:

$$\begin{aligned} \text{Dynamic measuring time} = & \text{Time of current, elapsed update time} \\ & \text{minus} \\ & \text{Time of last pulse} \end{aligned}$$

When the update time has elapsed, an estimated measured value is calculated with the dynamic measuring time under the assumption that a pulse occurred at the end of the update time.

If the "1 Pulse per dynamic measuring time" estimated measured value is less than the last measured value during the frequency and speed measurement, this estimated measured value is output as the new measured value. With the period measurement, the dynamic measuring time is output as the estimated period if the dynamic measuring time is greater than the last measured period.

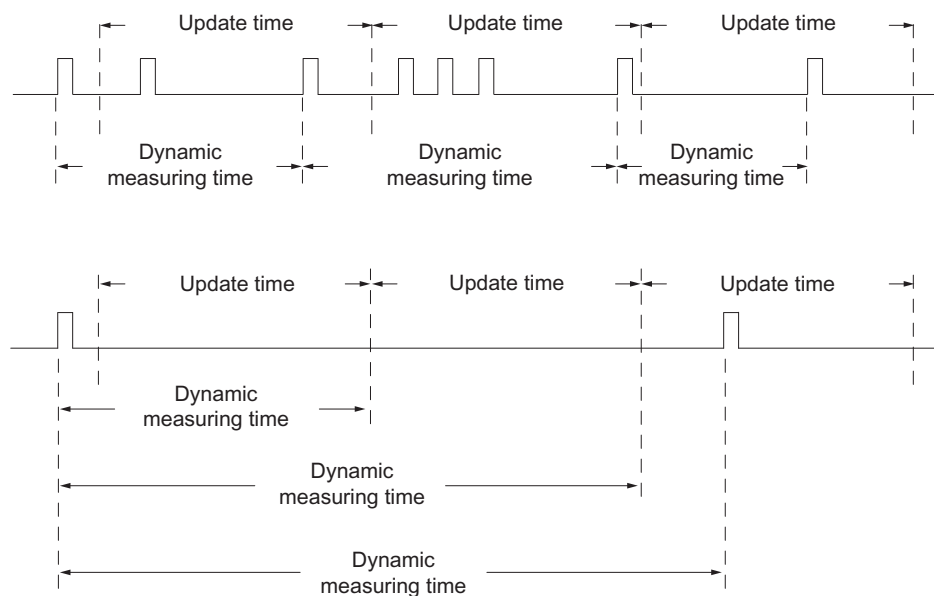

Figure 3-22 Measuring Principle

The 1Count5V measures continuously. When assigning parameters, you specify an update time.

During the time until the end of the first elapsed update time, a value of "-1" is returned.

The continuous measurement begins after the gate is opened with the first pulse of the pulse train to be measured. The first measured value can be calculated after the second pulse, at the earliest.

A measured value (frequency, period, or speed) is output in the feedback interface each time the update time elapses. The end of a measurement is indicated with the STS_CMP1 status bits. This bit is reset with the RES_STS and RES_STS_A bits according to the complete acknowledgement principle.

If the direction of rotation is reversed during an update time, the measured value for this measurement period is undefined. By evaluating the STS_C_DN and STS_C_UP feedback bits (direction evaluation), you can respond to any process irregularities.

The following figure illustrates the principle of continuous measurement using frequency measurement as an example.

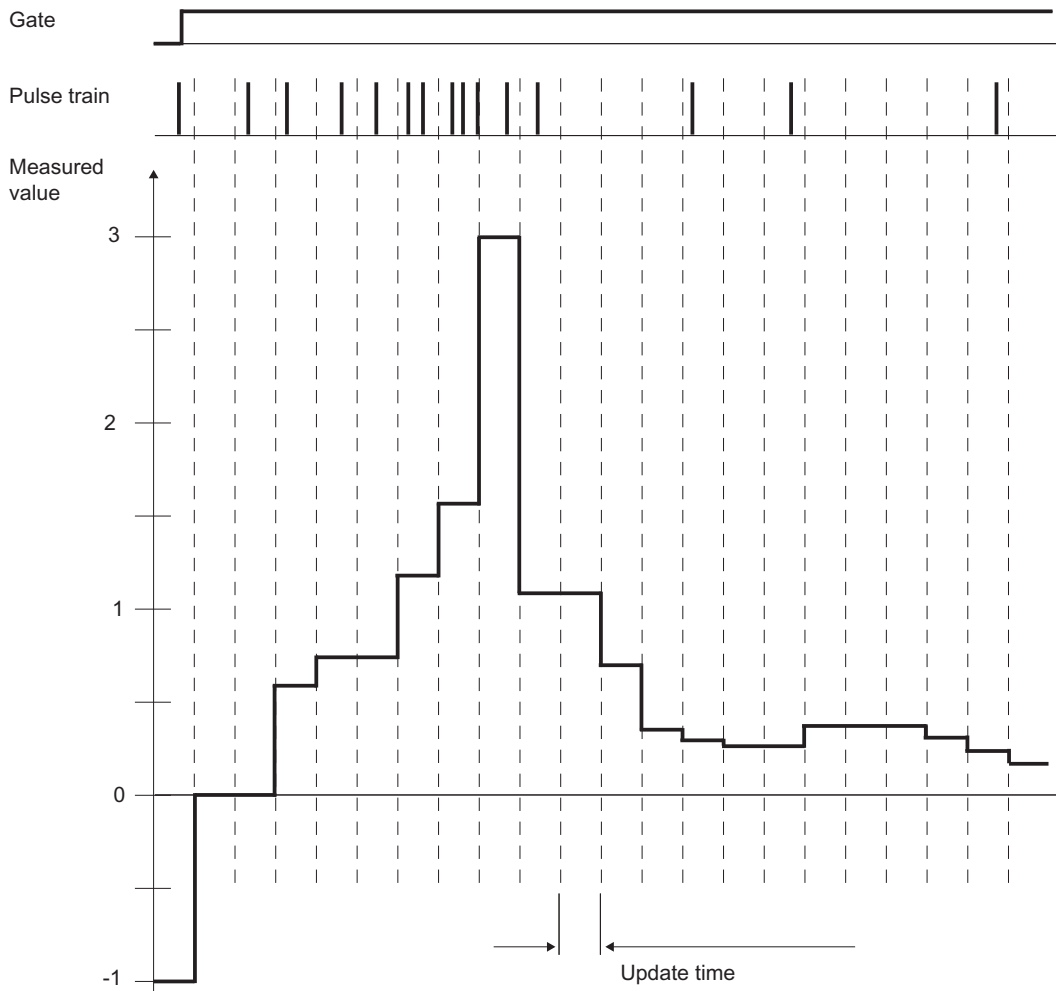

Figure 3-23 Principle of Continuous Measurement (Frequency Measurement Example)

Gate Control

To control the 1Count5V, you have to use the gate functions.

Isochronous Mode

In isochronous mode, the 1Count5V accepts control bits and control values from the control interface in each bus cycle and reports back the response in the same cycle.

In each cycle, the 1Count5V transfers a measured value and the status bits that were valid at time T_i .

The measurement starts and ends at time T_i .

Integration Time/Update Time in Isochronous Mode

If the integration time/update time lasts several T_{DP} cycles, you can recognize the new measured value in the user program at the bit STS_CMP1 status bit (measurement completed) of the feedback interface. This enables monitoring of the measuring operation or a synchronization with the measuring operation. It takes 4 T_{DP} cycles, however, for this message to be acknowledged. The minimum integration time/update time in this case is $(4 \times T_{DP})$.

If the application can tolerate a jitter in the integration time of a T_{DP} and a measured value that remains constant for several cycles, you don't have to continually evaluate status bit STS_CMP1. Integration times/update times of $(1 \times T_{DP})$ to $(3 \times T_{DP})$ are then possible.

Because isochronous operation was lost in the last T_{DP} cycle of the integration time, the integration time is increased by one T_{DP} cycle. This does not corrupt the measured value.

Note

The value range limits for the integration time/update time must not be exceeded (see tables for the individual measuring modes).

A violation of the value range limits will result in a parameter assignment error, and the 1Count5V will not go into isochronous mode.

Note

When you change the configuration from non-isochronous to isochronous mode and vice versa, you must always adjust the integration time/update time parameter if you want to keep the length of the integration time/update time.

3.7.3 Frequency measurement with integration time

Definition

In frequency measurement mode, the 1Count5V counts the pulses that arrive within a set integration time.

Integration time

You preset the integration time with the integration time parameter (see table).

Table 3- 10 Calculation of the Integration Time

Boundary conditions		Integration time	Range of n	
			n _{min}	n _{max}
Non-isochronous mode	Any T _{DP}	n x 10 ms	1	1000
Isochronous mode	T _{DP} < 10 ms	n x T _{DP}	(10 ms/T _{DP} [ms]) + 1 ¹	1000
	T _{DP} ≥ 10 ms	n x T _{DP}	1	10000 ms/T _{DP} [ms] ¹

¹ Any digits after the decimal point that come about after dividing by T_{DP} are omitted. It is not permitted to violate these limits. If these limits are violated, the 1Count5V generates a parameter assignment error and will not go into isochronous mode.

Frequency measurement

The value of the calculated frequency is made available in the unit 10⁻³ Hz. The measured frequency value can be read in the feedback interface (byte 0 to 3).

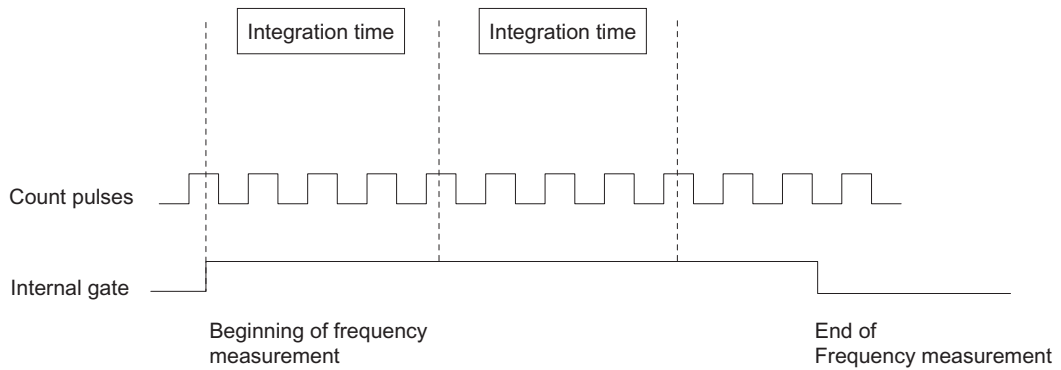

Figure 3-24 Frequency Measurement with Gate Function

Limit-Value Monitoring

The following value ranges are permitted for limit-value monitoring:

Low limit f_u	High limit f_o
0 to $499,999,999 \times 10^{-3}$ Hz	f_u+1 to $500,000,000 \times 10^{-3}$ Hz

Possible Measuring Ranges with Error Indication

Integration time	$f_{\min} \pm \text{absolute error}$	$f_{\max} \pm \text{absolute error}$
10 s	0.1 Hz \pm 0.001 Hz	500 000 Hz \pm 90 Hz
1 s	1 Hz \pm 0.001 Hz	500 000 Hz \pm 55 Hz
0.1 s	10 Hz \pm 0.002 Hz	500 000 Hz \pm 52 Hz
0.01 s	100 Hz \pm 0.013 Hz	500 000 Hz \pm 63 Hz

3.7.4 Continuous Frequency Measurement

Definition

In frequency measurement mode, the 1Count5V counts the pulses that arrive within a dynamic measuring period.

Update Time

The 1Count5V updates the measured values cyclically. You preset the update time with the Update Time parameter (see table). You can change the update time during operation.

Table 3- 11 Calculation of the Update Time

Boundary conditions		Update time	Range of n	
			n _{min}	n _{max}
Non-isochronous mode	Any T _{DP}	n x 10 ms	1	1000
Isochronous mode	T _{DP} < 10 ms	n x T _{DP}	(10 ms/T _{DP} [ms]) + 1 ¹	1000
	T _{DP} ≥ 10 ms	n x T _{DP}	1	10000 ms/T _{DP} [ms] ¹

¹ Any digits after the decimal point resulting from division by T_{DP} are omitted. These limits may not be violated. If these limits are violated, the 1Count5V generates a parameter assignment error and will not go into isochronous mode.

Frequency measurement

The value of the calculated frequency is made available in the unit 10⁻³ Hz. The measured frequency value can be read in the feedback interface (byte 0 to 3).

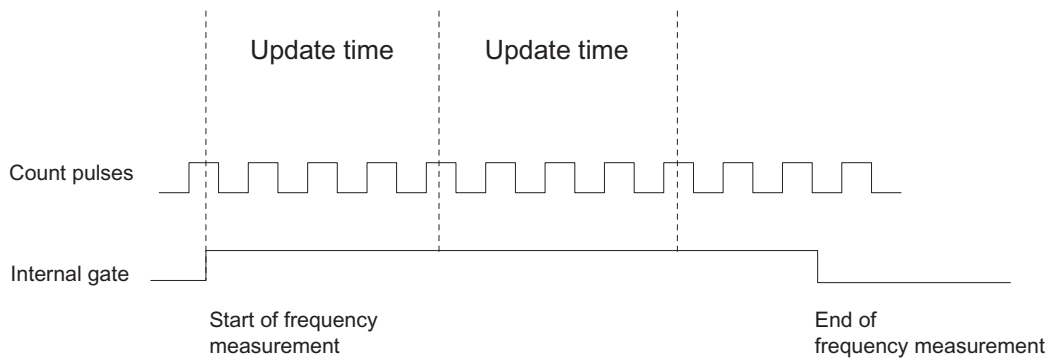

Figure 3-25 Frequency Measurement with Gate Function

Limit-Value Monitoring

The following value ranges are permitted for limit-value monitoring:

Encoder type	Low limit f_u	High limit f_o
5-V encoders	0 to $499,999,999 \times 10^{-3}$ Hz	f_u+1 to $500,000,000 \times 10^{-3}$ Hz

Possible Measuring Ranges with Error Indication

Frequency f	Absolute error
0.1 Hz	± 0.001 Hz
1 Hz	± 0.001 Hz
10 Hz	± 0.003 Hz
100 Hz	± 0.02 Hz
1 000 Hz	± 0.18 Hz
10 000 Hz	± 1.8 Hz
100 000 Hz	± 18 Hz
500 000 Hz	± 90 Hz

Function of the Digital Input

For the "Function DI" parameter, select one of the following functions for the digital input:

- Input
- HW gate (see section "Gate Functions in Measurement Modes (Page 185)")

Function of the Digital Output DO1

For the "Function DO1" parameter, select one of the following functions for the DO1 digital output:

- Output (no switching by the limit-value monitoring)
- Measured value outside the limits
- Measured value under the low limit
- Measured value over the high limit

(see section "Behavior of the Outputs in Measurement Modes (Page 186)")

Function of the Digital Output DO2

- Output

(see section "Behavior of the Outputs in Measurement Modes (Page 186)")

Changing Values during Operation

The following values can be changed during operation:

- Low limit (LOAD_PREPARE)
- High limit (LOAD_VAL)
- Function of the Digital Output DO1 (C_DOPARAM)
- Integration time/update time (C_INTTIME)

(see sections "Behavior of the Outputs in Measurement Modes (Page 186)" and "Assignment of the Feedback and Control Interfaces for the Measurement Modes (Page 188)")

3.7.5 Rotational speed measurement with integration time

Definition

In rotational speed measurement mode, the 1Count5V counts the pulses that arrive from a tachometer generator within a set integration time and calculates the speed of the connected motor.

Integration time

You preset the integration time with the Integration Time parameter.

Table 3- 12 Calculation of the Integration Time

Boundary conditions		Integration time	Range of n	
			n _{min}	n _{max}
Non-isochronous mode	Any T _{DP}	n x 10 ms	1	1000
Isochronous mode	T _{DP} < 10 ms	n x T _{DP}	(10 ms/T _{DP} [ms]) + 1 ¹	1000
	T _{DP} ≥ 10 ms	n x T _{DP}	1	10000 ms/T _{DP} [ms] ¹

¹ Any digits after the decimal point resulting from division by T_{DP} are omitted. These limits may not be violated. If these limits are violated, the 1Count5V generates a parameter assignment error and will not go into isochronous mode.

Rotational Speed Measurement

For rotational speed measurement mode, you also have to assign the pulses per encoder or motor revolution.

The rotational speed is returned in the unit 1×10^{-3} /min.

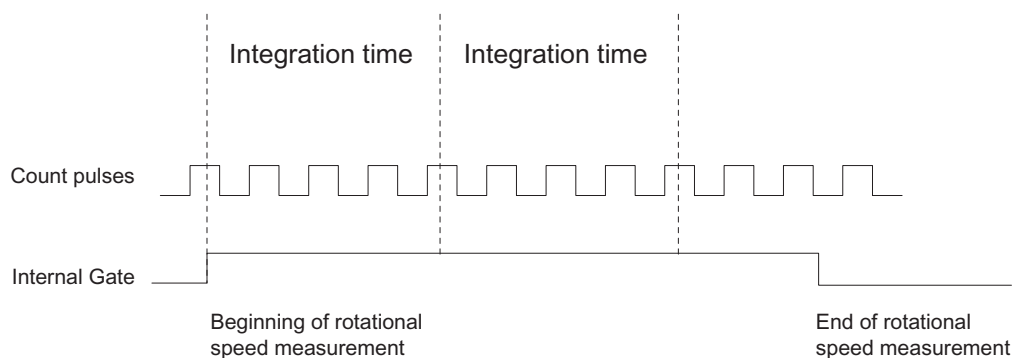

Figure 3-26 Rotational Speed Measurement with Gate Function

Limit-Value Monitoring

The following value ranges are permitted for limit-value monitoring:

Low limit n_u	High limit n_o
0 to $24\,999\,999 \times 10^{-3}$ /min	n_u+1 to $25\,000\,000 \times 10^{-3}$ /min

Possible Measuring Ranges with Error Indication

Table 3- 13 Possible Measuring Ranges with Error Indication (Number of Pulses per Encoder Revolution = 60)

Integration time	$n_{min} \pm \text{absolute error}$	$n_{max} \pm \text{absolute error}$
10 s	1 /min \pm 0.03 /min	25 000 /min \pm 4.5 /min
1 s	1 /min \pm 0.03 /min	25 000 /min \pm 2.8 /min
0.1 s	10 /min \pm 0.03 /min	25 000 /min \pm 2.6 /min
0.01 s	100 /min \pm 0.04 /min	25 000 /min \pm 3.2 /min

3.7.6 Continuous Rotational Speed Measurement

Definition

In rotational speed measurement mode, the 1Count5V counts the pulses that are received from a tachometer generator within a dynamic measuring time, and calculates the speed from this value with the number of pulses per encoder revolution.

Update time

The 1Count5V updates the measured values cyclically. You preset the update time with the Update Time parameter (see table). You can change the update time during operation.

Table 3- 14 Calculation of the Integration Time

Boundary conditions		Update time	Range of n	
			n _{min}	n _{max}
Non-isochronous mode	Any T _{DP}	n x 10 ms	1	1000
Isochronous mode	T _{DP} < 10 ms	n x T _{DP}	(10 ms/T _{DP} [ms]) + 1 ¹	1000
	T _{DP} ≥ 10 ms	n x T _{DP}	1	10000 ms/T _{DP} [ms] ¹

¹ Any digits after the decimal point that come about after dividing by T_{DP} are omitted. These limits may not be violated. If these limits are violated, the 1Count5V generates a parameter assignment error and will not go into isochronous mode.

Rotational Speed Measurement

For rotational speed measurement mode, you also have to assign the pulses per encoder or motor revolution.

The rotational speed is returned in the unit 1×10^{-3} /min.

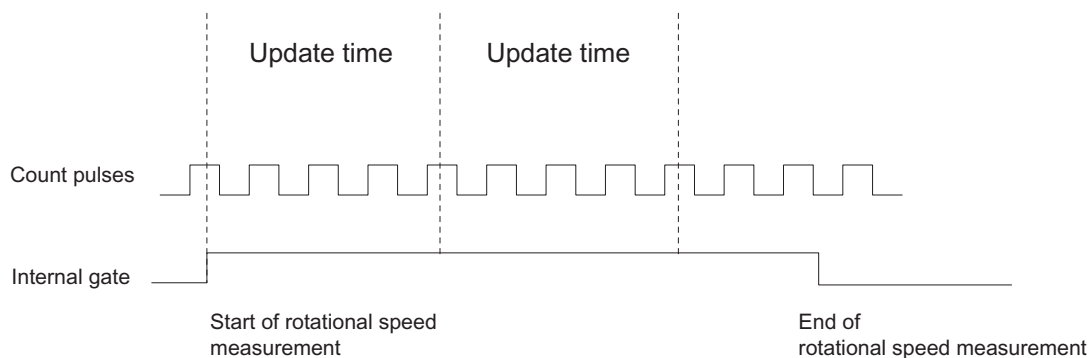

Figure 3-27 Rotational Speed Measurement with Gate Function

Limit-Value Monitoring

The following value ranges are permitted for limit-value monitoring:

Low limit n_u	High limit n_o
0 to $24\,999\,999 \times 10^{-3}$ /min	n_u+1 to $25\,000\,000 \times 10^{-3}$ /min

Possible Measuring Ranges with Error Indication (Number of Pulses per Encoder Revolution = 60)

Rotational speed n	Absolute error
1 /min	± 0.04 /min
10 /min	± 0.04 /min
100 /min	± 0.05 /min
1 000 /min	± 0.21 /min
10 000 /min	± 1.82 /min
25 000 /min	± 4.5 /min

Function of the Digital Input

For the "Function DI" parameter, select one of the following functions for the digital input:

- Input
- HW gate (see section "Gate Functions in Measurement Modes (Page 185)")

Function of the Digital Output DO1

For the "Function DO1" parameter, select one of the following functions for the DO1 digital output:

- Output (no switching by the limit-value monitoring)
- Measured value outside the limits
- Measured value under the low limit
- Measured value over the high limit

(see section "Behavior of the Outputs in Measurement Modes (Page 186)")

Function of the Digital Output DO2

- Output

(see section "Behavior of the Outputs in Measurement Modes (Page 186)")

Changing Values during Operation

The following values can be changed during operation:

- Low limit (LOAD_PREPARE)
- High limit (LOAD_VAL)
- Function of the digital output DO1 (C_DOPARAM)
- Integration time/update time (C_INTTIME)

(see sections "Behavior of the Outputs in Measurement Modes (Page 186)" and "Assignment of the Feedback and Control Interfaces for the Measurement Modes (Page 188)")

3.7.7 Period measurement with integration time

Definition

In period measurement mode, the 1Count5V measures the time between two positive edges of the counting signal by counting the pulses of an internal quartz-accurate reference frequency (16 MHz) within a preset integration time.

Integration Time

You preset the integration time with the Integration Time parameter (see the table below).

Boundary conditions		Integration time	Range of n	
			n _{min}	n _{max}
Non-isochronous mode	Any T _{DP}	n x 10 ms	1	12000
Isochronous mode	T _{DP} < 10 ms	n x T _{DP}	10 ms/T _{DP} [ms] + 1 ¹	12000
	T _{DP} ≥ 10 ms	n x T _{DP}	1	120 000 ms/T _{DP} [ms] ¹

¹ Any digits after the decimal point that come about after dividing by T_{DP} are omitted. These limits must not be violated. If these limits are violated, the 1Count5V generates a parameter assignment error and will not go into isochronous mode.

Period Measurement

The value of the calculated period is given in the unit 1 μs or 1/16 μs. The measured period can be read in the feedback interface (byte 0 to 3).

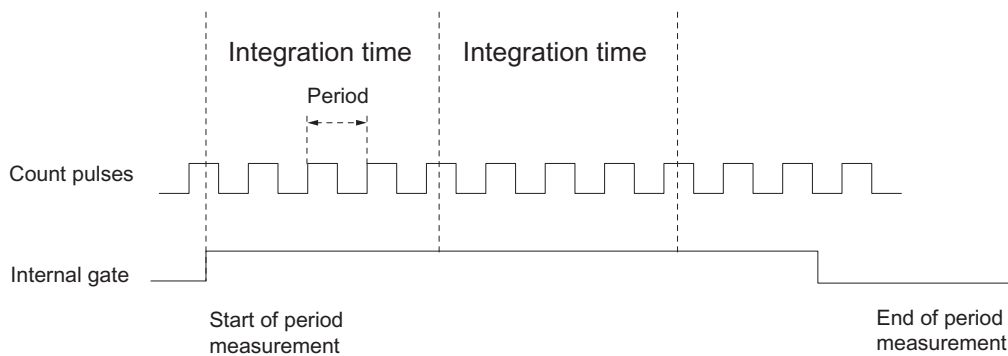

Figure 3-28 Period Measurement with Gate Function

Limit-Value Monitoring

The following value ranges are permitted for limit-value monitoring:

1 μ s resolution

Low limit T_u	High limit T_o
0 to 119 999 999 μ s	T_u+1 to 120 000 000 μ s

1/16 μ s resolution

Low limit T_u	High limit T_o
0 to 1 919 999 999 μ s	T_u+1 to 1 920 000 000 μ s

Possible Measuring Ranges with Error Indication

1 μ s resolution

Integration time	$T_{\min} \pm$ absolute error	$T \pm$ absolute error
100 s	1 μ s* (10 \pm 0)	1 μ s* (100 000 000 \pm 10 000)
10 s	1 μ s* (10 \pm 0)	1 μ s* (10 000 000 \pm 1 000)
1 s	1 μ s* (10 \pm 0)	1 μ s* (1 000 000 \pm 100)
0.1 s	1 μ s* (10 \pm 0)	1 μ s* (100 000 \pm 10)
0.01 s	1 μ s* (10 \pm 0)	1 μ s* (10 000 \pm 1)

1/16 μ s resolution

Integration time	$T_{\min} \pm$ absolute error	$T \pm$ absolute error
100 s	1/16 μ s* (160 \pm 0)	1/16 μ s* (1 600 000 000 \pm 160 000)
10 s	1/16 μ s* (160 \pm 0)	1/16 μ s* (160 000 000 \pm 16 000)
1 s	1/16 μ s* (160 \pm 0)	1/16 μ s* (16 000 000 \pm 1 600)
0.1 s	1/16 μ s* (160 \pm 0)	1/16 μ s* (1 600 000 \pm 160)
0.01 s	1/16 μ s* (160 \pm 0)	1/16 μ s* (160 000 \pm 16)

3.7.8 Continuous Period Measurement

Definition

In period measurement mode, the 1Count5V indicates the dynamic measuring time as a period. If the period is less than the update time, then an average is calculated for the period.

Update Time

The 1Count5V updates the measured values cyclically. You preset the update time with the Update Time parameter (see table). You can change the update time during operation.

Boundary conditions		Update time	Range of n	
			n _{min}	n _{max}
Non-isochronous mode	Any T _{DP}	n x 10 ms	1	12000
Isochronous mode	T _{DP} < 10 ms	n x T _{DP}	(10 ms/T _{DP} [ms]) + 1 ¹	12000
	T _{DP} ≥ 10 ms	n x T _{DP}	1	120 000 ms/T _{DP} [ms] ¹

¹ Any digits after the decimal point that come about after dividing by T_{DP} are omitted. These limits may not be violated. If these limits are violated, the 1Count5V generates a parameter assignment error and will not go into isochronous mode.

Period measurement

The value of the calculated period is given in the unit 1 μs or 1/16 μs. The measured period can be read in the feedback interface (byte 0 to 3).

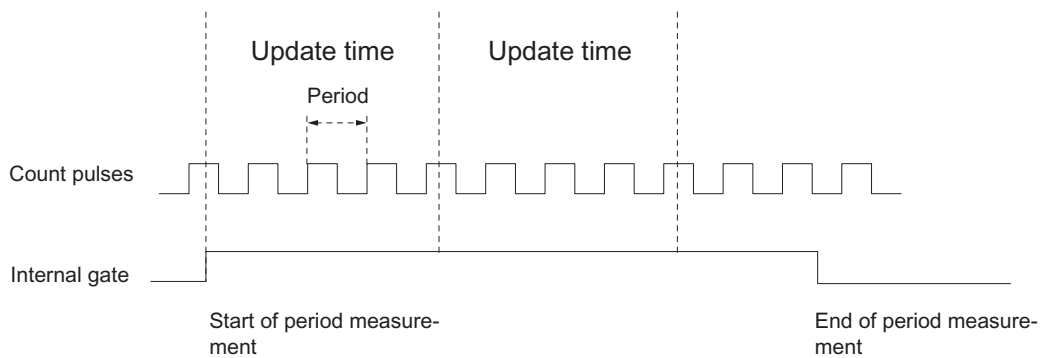

Figure 3-29 Period Measurement with Gate Function

Limit-Value Monitoring

The following value ranges are permitted for limit-value monitoring:

1 μ s resolution

Low limit T_u	High limit T_o
0 to 119 999 999 μ s	T_u+1 to 120 000 000 μ s

1/16 μ s resolution

Low limit T_u	High limit T_o
0 to 1 919 999 999 μ s	T_u+1 to 1 920 000 000 μ s

Possible Measuring Ranges with Error Indication

1 μ s resolution

Period $T_{min} \pm$ absolute error	Period $T_{min} \pm$ absolute error
1 μ s* (10 \pm 0)	1 μ s* (100 000 \pm 10)
1 μ s* (100 \pm 0)	1 μ s* (1 000 000 \pm 100)
1 μ s* (1 000 \pm 0)	1 μ s* (10 000 000 \pm 1 002)
1 μ s* (10 000 \pm 1)	1 μ s* (100 000 000 \pm 10 020)

1/16 μ s resolution

Period $T_{min} \pm$ absolute error	Period $T_{min} \pm$ absolute error
1/16 μ s* (160 \pm 1)	1/16 μ s* (1 600 000 \pm 160)
1/16 μ s* (1 600 \pm 1)	1/16 μ s* (16 000 000 \pm 1 600)
1/16 μ s* (16 000 \pm 3)	1/16 μ s* (160 000 000 \pm 16 000)
1/16 μ s* (160 000 \pm 20)	1/16 μ s* (1 600 000 000 \pm 160 000)

Function of the Digital Input

For the "Function DI" parameter, select one of the following functions for the digital input:

- Input
- HW gate (see section "Gate Functions in Measurement Modes (Page 185)")

Function of the Digital Output DO1

For the "Function DO1" parameter, select one of the following functions for the digital output:

- Output (no switching by the limit-value monitoring)
- Measured value outside the limits
- Measured value under the low limit
- Measured value over the high limit

(see section "Behavior of the Outputs in Measurement Modes (Page 186)")

Function of the Digital Output DO2

- Output

(see section "Behavior of the Outputs in Measurement Modes (Page 186)")

Changing Values during Operation

The following values can be changed during operation:

- Low limit (LOAD_PREPARE)
- High limit (LOAD_VAL)
- Function of the digital output DO1 (C_DOPARAM)
- Integration time/update time (C_INTTIME)

(see sections "Behavior of the Outputs in Measurement Modes (Page 186)" and "Assignment of the Feedback and Control Interfaces for the Measurement Modes (Page 188)")

3.7.9 Gate Functions in Measurement Modes

Software Gate and Hardware Gate

The 1Count5V has two gates

- A software gate (SW gate), which is controlled by the SW_GATE control bit.
The software gate can only be opened by a positive edge of the SW_GATE control bit. It is closed when this bit is reset. Note the transfer times and run times of your control program.
- A hardware gate (HW gate), which is controlled by means of the digital input on the 1Count5V. You assign the hardware gate as the function of the digital input (Function DI "HW gate"). It is opened on a positive edge at the digital input and closed on a negative edge.

Internal gate

The internal gate is the logical AND operation of the HW gate and SW gate. Counting is only active when the HW gate and the SW gate are open. The STS_GATE feedback bit (internal gate status) indicates this. If a HW gate has not been assigned, the setting of the SW gate is decisive.

Gate Control

Gate control by means of the SW gate only

The opening/closing of the SW gate starts/stops measurement.

If the SW gate is opened in isochronous mode in bus cycle "n" by setting the SW_GATE control bit, measurement starts at time T_i in cycle "n+1".

Gate control by means of the SW gate and HW gate

The opening and closing of the SW gate with the HW gate open starts/stops measurement.

The opening and closing of the HW gate with the SW gate open starts/stops measurement.

The SW gate is opened/closed by means of the control interface with the SW_GATE bit.

The HW gate is opened/closed by means of a 24-V signal on the digital input.

In isochronous mode, when the SW gate is open, measurement starts at time T_i , immediately after the HW gate has opened. The measurement ends at time T_i , which occurs immediately after the HW gate has closed.

When the HW gate is open, the measurement starts at time T_i in the cycle, immediately after the SW has opened, and ends at time T_i in the cycle, which occurs immediately after the SW gate has closed.

3.7.10 Behavior of the Outputs in Measurement Modes

Introduction

The various ways of setting the behavior of the outputs are described in this section.

Behavior of the Outputs in Measurement Modes

You can assign parameters for the digital outputs of the 1Count5V.

You can store a high and a low limit for frequency measurement, rotational speed measurement or period measurement. If the limits are violated, digital output DO1 is activated. These limit values can be assigned and changed with the load function.

You can change the function and the behavior of the digital outputs during operation. The new function takes effect immediately. In isochronous mode it always takes effect at time T_i .

You can choose from the following functions:

- Output
- Measured value outside the limits (limit-value monitoring)
- Measured value under the low limit (limit-value monitoring)
- Measured value over the high limit (limit-value monitoring)

Output

If you want to switch the outputs on or off, you must enable them with the CTRL_DO1 and CTRL_DO2 control bits.

You can switch the outputs on and off with the control bits SET_DO1 and SET_DO2.

You can query the status of the outputs with the status bits STS_DO1 and STS_DO2 in the feedback interface.

In isochronous mode, the outputs are switched at time T_o .

Limit-Value Monitoring

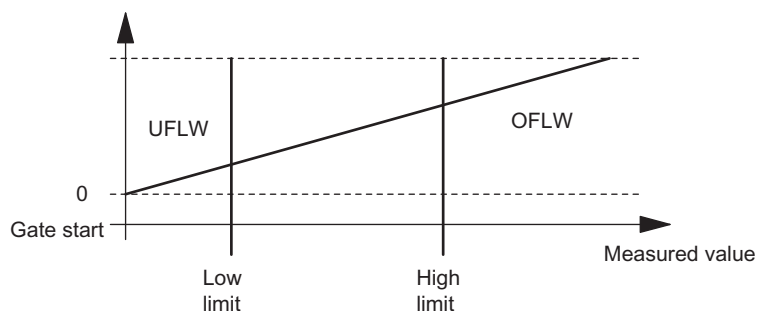

Figure 3-30 Limit-Value Monitoring

After the integration time elapses, the measured value obtained (frequency, rotational speed, or period) is compared with the assigned limit values.

If the current measured value is under the assigned low limit (measured value < low limit), bit STS_UFLW = 1 is set in the feedback interface.

If the current measured value is over the assigned high limit (measured value > high limit), bit STS_OFLW = 1 is set in the feedback interface.

You must acknowledge these bits with the RES_STS control bit.

If the measured value is still outside or again outside the limits after acknowledgment, the corresponding status bit is set again.

If you set the low limit at 0, you switch off dynamic monitoring of violation of the low limit value.

Depending on the parameter assignment, the enabled digital output DO1 can be set by the limit-value monitoring:

"Function DO1" parameter	DO1 is set ...
Measured value outside the limits	Measured value < low limit OR measured value > high limit
Measured value under the low limit	Measured value < low limit
Measured value over the high limit	Measured value > high limit

In isochronous mode, the output is switched at time T_i .

3.7.11 Assignment of the Feedback and Control Interfaces for the Measurement Modes

Note

For the 1Count5V, the following data of the control and feedback interface are consistent:
 Bytes 0 to 3
 Bytes 4 to 7
 Bytes 8 to 11 (modified user data interface)

Use the access or addressing mode for data consistency over the entire control and feedback interface on your master (only for configuration using the GSD file).

Assignment Tables

Table 3- 15 Feedback Interface (Inputs)

Address	Assignment	Designation
Bytes 0 to 3	Measured value	
Byte 4	Bit 7: Short circuit of the encoder supply Bit 6: Short circuit / wire break / overtemperature Bit 5: Parameter assignment error Bit 4: Short circuit / wire break / overtemperature Bit 3: Short circuit / wire break / encoder signal Bit 2: Resetting of status bits active Bit 1: Load function error Bit 0: Load function is running	ERR_24V ERR_DO1 ERR_PARA ERR_DO2 ERR_ENCODER RES_STS_A ERR_LOAD STS_LOAD
Byte 5	Bit 7: Down direction status Bit 6: Up direction status Bit 5: Reserve = 0 Bit 4: DO2 status Bit 3: DO1 status Bit 2: Reserve = 0 Bit 1: DI status Bit 0: Internal gate status	STS_C_DN STS_C_UP STS_DO2 STS_DO1 STS_DI STS_GATE
Byte 6	Bit 7: Reserve = 0 Bit 6: Low limit of measuring range Bit 5: High limit of measuring range Bit 4: Reserve = 0 Bit 3: Measurement completed Bit 2: Reserve = 0 Bit 1: Reserve = 0 Bit 0: Reserve = 0	STS_UFLW STS_OFLW STS_CMP1
Byte 7	Reserve = 0	
Bytes 8 to 11	Count value ¹	

¹ Modified user data interface

Table 3- 16 Control Interface (Outputs)

Address	Assignment			
Bytes 0 to 3	Low limit or high limit			
	Function of DO1			
	Byte 0:	Bit 1	Bit 0	Function DO1
		0	0	Output
		0	1	Measured value outside the limits
		1	0	Measured value under the low limit
	1	1	Measured value over the high limit	
	Bytes 1 to 3:	Reserve = 0		
	Integration time/update time			
	Byte 0, 1:	Integration time [n*10ms] (Range 1 to 1000/12000)		
	Byte 2, 3:	Reserve = 0		
Byte 4	Bit 7:	Error diagnostics acknowledgement EXTF_ACK		
	Bit 6:	Enable DO2 CTRL_DO2		
	Bit 5:	Control bit DO2 SET_DO2		
	Bit 4:	Enable DO1 CTRL_DO1		
	Bit 3:	Control bit DO1 SET_DO1		
	Bit 2:	Start resetting of status bit RES_STS		
	Bit 1:	Reserve = 0		
	Bit 0:	SW gate control bit SW_GATE		
Byte 5	Bit 7:	Reserve = 0		
	Bit 6:	Reserve = 0		
	Bit 5:	Reserve = 0		
	Bit 4:	Change function of DO1, C_DOPARAM		
	Bit 3:	Reserve = 0		
	Bit 2:	Change integration time, C_INTTIME		
	Bit 1:	Load high limit LOAD_PREPARE		
	Bit 0:	Load low limit LOAD_VAL		
Bytes 6 to 7	Reserve = 0 ¹			
¹ Not used for modified user interface				

Notes on the Control Bits

Table 3- 17 Notes on the Control Bits

Control bits	Notes
C_DOPARAM	Change function of DO1 The value from byte 0 is adopted as the new function of DO1.
C_INTTIME	Change integration time The value from bytes 0 and 1 is adopted as the new integration time for the next measurement.
CTRL_DO1	Enable DO1 You use this bit to enable the DO1 output.
CTRL_DO2	Enable DO2 You use this bit to enable the DO2 output.
EXTF_ACK	Error acknowledgment The error bits must be acknowledged with the EXTF_ACK control bit after the cause is removed.
LOAD_PREPARE	Load high limit The value from bytes 0 to 3 is adopted as the new high limit.
LOAD_VAL	Load low limit The value from bytes 0 to 3 is adopted as the new low limit.
RES_STS	Start resetting of status bit The status bits are reset by means of the acknowledgment process between the RES_STS bit and the RES_STS_A bit.
SET_DO1	Control bit DO1 Switches the DO1 digital output on and off when CTRL_DO1 is set.
SET_DO2	Control bit DO2 Switches the DO2 digital output on and off when CTRL_DO2 is set.
SW_GATE	SW gate control bit The SW gate is opened/closed via the control interface with the SW_GATE bit.

Notes on the Feedback Bits

Table 3- 18 Notes on the Feedback Bits

Feedback bits	Notes
ERR_24V	Short circuit of the encoder supply The error bit must be acknowledged by the EXTF_ACK control bit. Diagnostic message if assigned.
ERR_DO1	Short circuit/wire break/overtemperature at output DO1 The error bit must be acknowledged by the EXTF_ACK control bit. Diagnostic message if assigned.
ERR_DO2	Short circuit/wire break/overtemperature at output DO2 The error bit must be acknowledged by the EXTF_ACK control bit. Diagnostic message if assigned.
ERR_ENCODER	Short circuit / wire break / encoder signal The error bit must be acknowledged by the EXTF_ACK control bit Diagnostic message if assigned.
ERR_LOAD	Load function error The LOAD_VAL, LOAD_PREPARE, C_DOPARAM, and C_INTTIME bits cannot be set simultaneously during transfer. This results in setting the ERR_LOAD status bit, similar to loading an incorrect value (which is not accepted).
ERR_PARA	Parameter Assignment Error ERR_PARA
RES_STS_A	Resetting of status bits active
STS_C_DN	Down direction status
STS_C_UP	Up direction status
STS_CMP1	Measurement completed After every elapsed time interval (update time/integration time), the measured value is updated Measurement with integration time The end of a measurement (after the interval has elapsed) is indicated with the STS_CMP1 status bit. Continuous measurement At the end of the update time, the end of the measurement is signaled with status bit STS_CMP1 if a measured value is output. The bit remains 0 if an estimated measured value is output. This bit is reset by the RES_STS control bit in the control interface.
STS_DI	DI status The status of the DI is indicated in all modes with the STS_DI bit in the feedback interface.
STS_DO1	DO1 status
STS_DO2	DO2 status
STS_GATE	Internal gate status: Measuring
STS_LOAD	Load function is running
STS_OFLW	High measuring limit violated
STS_UFLW	Low measuring limit violated
	Both bits must be reset.

Access to the Control and Feedback Interface in STEP 7 Programming

Table 3- 19 Access to the Control and Feedback Interface in STEP 7 Programming

	Configuring with STEP 7 using the GSD file ¹⁾ (Hardware catalog\PROFIBUS-DP\Additional FIELD DEVICES\I/O\ET 200S)	Configuring with STEP 7 using HW Config (Hardware catalog\PROFIBUS-DP\ET 200S)
Feedback interface	Read with SFC 14 "DPRD_DAT"	Load command (e.g. L PID)
Control interface	Write with SFC 15 "DPWR_DAT"	Transfer command, e.g. T PQD
¹ Load and transfer commands are also possible with CPU 3xxC, CPU 3xx with MMC, and CPU 4xx (V3.0 and later).		

Resetting of the Status Bits STS_CMP1, STS_OFLW, STS_UFLW

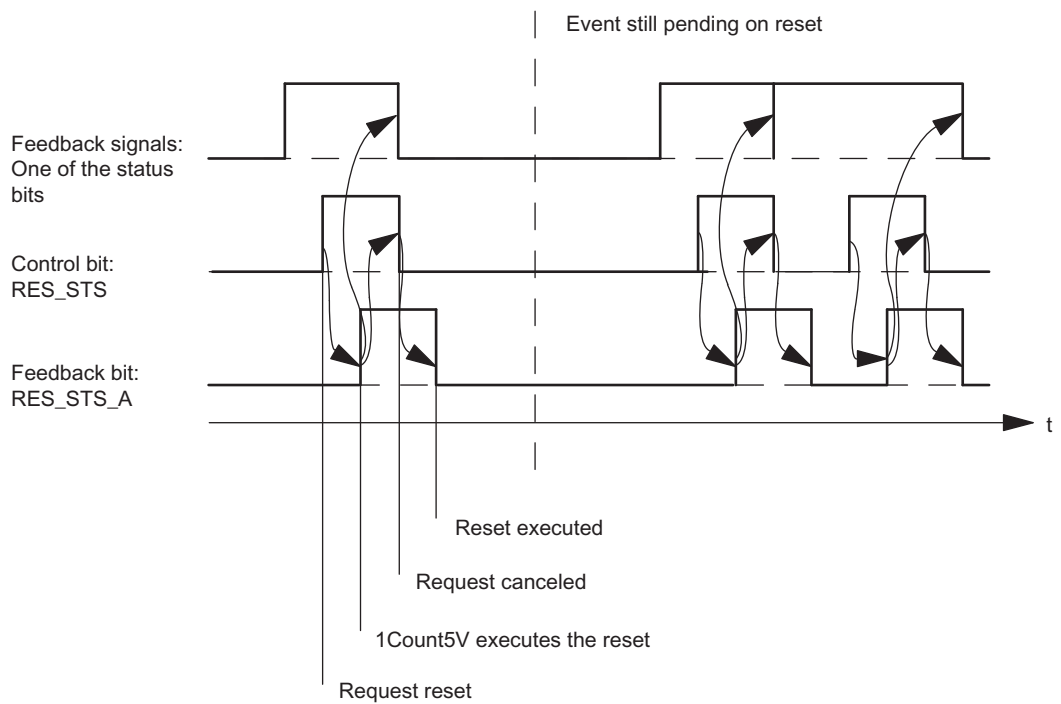

Figure 3-31 Resetting of the Status Bits

Acceptance of Values with the Load Function

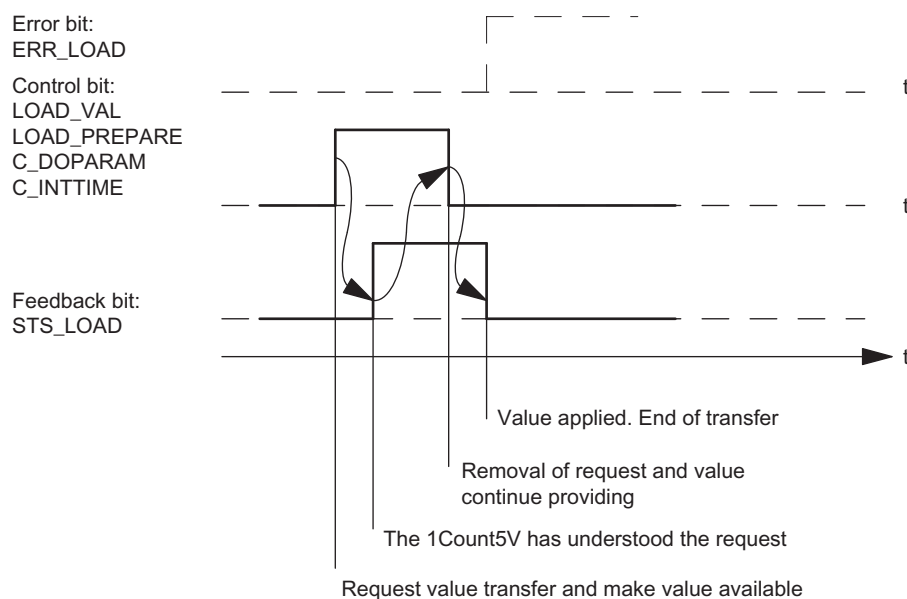

Figure 3-32 Acceptance of Values with the Load Function

Note

Only one of the following control bits can be set at a particular time:

LOAD_VAL or LOAD_PREPARE or C_DOPARAM or C_INTTIME.

Otherwise, the ERR_LOAD error is reported until all the specified control bits are deleted again.

The ERR_LOAD error bit is only deleted when a correct value is transferred as follows.

Acknowledgment Principle in Isochronous Mode

In isochronous mode, exactly 4 bus cycles are always required to reset the status bits and to accept values during the load function.

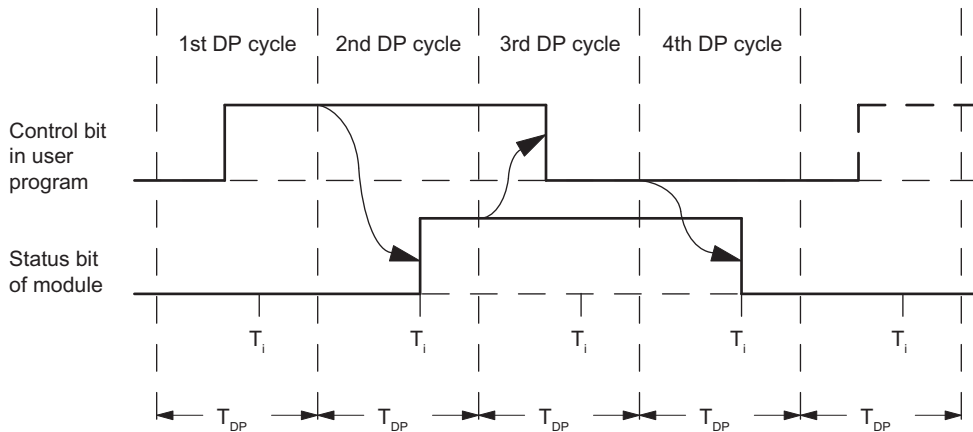

Figure 3-33 Acknowledgment Principle in Isochronous Mode

Error Detection

The diagnostic errors must be acknowledged. They have been detected by the 1Count5V and are indicated at the feedback interface. Channel-specific diagnostics are performed if you have enabled group diagnostics in your configuration (see device manual of the interface module used).

The parameter assignment error bit is acknowledged by means of correct parameter assignment.

An error has occurred, the 1Count5V sets an error bit, a diagnostic message may appear, error detection continues

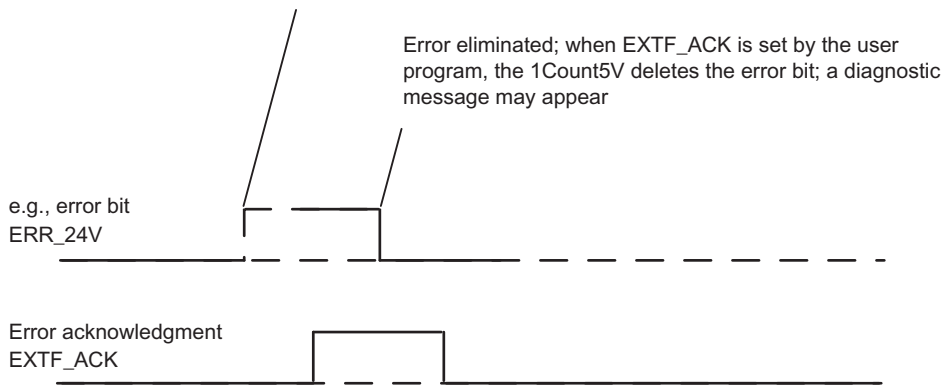

Figure 3-34 Error Acknowledgment

In the case of constant error acknowledgement ($EXT_F_ACK = 1$) or in CPU/master STOP mode, the 1Count5V reports the errors as soon as they are detected and clears the errors as soon as they are eliminated.

3.7.12 Parameter Assignment for Measurement Modes

Introduction

You can use either of the following to assign parameters for the 1Count5V:

- STEP 7 V5.3 SP2 or later
- A GSD file (<http://www.automation.siemens.com/csi/gsd>)

Parameter List for Measuring Modes

Table 3- 20 Parameter List for Measuring Modes

Parameter	Value Range	Default
Enable		
Group diagnostics	Disable/enable	Disable
Response to failure of the higher-level controller		
Response to CPU/master STOP	Turn off DO/ Continue working mode/ DO substitute a value/ DO keep last value	Turn off DO
Diagnostics A and B	Off/on	Off
Direction input B	Normal/Inverted	Normal
Output parameters		
Diagnostics DO1 ¹	Off/on	Off
Diagnostics DO2 ¹	Off/on	Off
Function DO1	Output/ Outside the limits/ Under the low limit/ Over the high limit	Output
Substitute value DO1	0/1	0
Substitute value DO2	0/1	0
Mode		
Measuring mode	Frequency measurement/ Rotational speed measurement/ Period measurement	Frequency measurement
Measuring method	With integration time/continuous	With integration time/
Resolution of period	1 μ s 1/16 μ s	1 μ s
Function DI	Input/HW gate	Input
Input signal HW gate	Normal/Inverted	Normal
Low limit	Frequency measurement: 0 to $f_{max}-1$ Rotational speed measurement: 0 to $n_{max}-1$ Period measurement: 0 to $T_{max}-1$	0 0 0

Parameter	Value Range	Default
High limit	Frequency measurement: Low limit+1 to f_{max} Rotational speed measurement: Low limit+1 to n_{max} Period measurement: Low limit+1 to T_{max}	f_{max} n_{max} T_{max}
Integration time [n*10ms]	Frequency measurement: 1...1000 Rotational speed measurement: 1...1000 Period measurement: 1... 12000	10 10 10
Encoder pulses per revolution ²	1...65535	1
¹ DO1/DO2 diagnostics (wire break, short circuit) are possible only with pulse lengths of >90 ms on digital output DO1/DO2. ² Only relevant in rotational speed measurement mode		

Parameter Assignment Error

The following parameter assignment errors may occur:

- Incorrect mode
- Low limit incorrect
- High limit incorrect
- Integration time incorrect
- Encoder pulses incorrect

What to Do in the Event of Errors

Check the set value ranges.

3.8 Fast mode

3.8.1 Overview

Introduction

This mode is suitable for position detection in especially short isochronous cycles.

This mode encompasses a subset of the functionality of the continuous counting mode.

It is intended for isochronous mode and differs from continuous counting by having a lower TDP Module_{min} and a TWA equal to zero. The module is operated in this mode as a pure input module, i.e., there is no control interface in this operating mode.

This mode is available starting with FW Version V2.0 of the module. The module must be configured as "1Count5V Fast Mode V2.0" in HW Config.

You can find the parameter assignment for "Fast Mode" in the chapter "Assigning parameters for fast mode (Page 203)".

Maximum Count Range

A total of 25 bits are available for the count value.

Load value

You can specify a load value for the 1Count5V.

This load value is applied directly as the start value.

Gate Control

To control the 1Count5V, you can use the HW gate.

State according to Parameter Assignment

Count value corresponds to the load value set in HW Config.

Isochrone Mode

In each cycle, the 1Count5V transfers the count and the status bits that were valid at time T_i .

3.8.2 Fast mode

Definition

In this mode, the 1Count5V counts continuously starting from the start value:

When counting up, if the 1Count5V reaches the maximum value that can be represented with 25 bits (all bits of the counter are set) and another count pulse arrives, the count value jumps to "0" and resumes counting from there without losing a pulse.

When counting down, if the 1Count5V reaches the value "0" and another count pulse arrives, the count value jumps to the maximum value that can be represented with 25 bits (all bits of the counter are set) and resumes counting without losing a pulse.

Function of the Digital Input

For the "Function DI" parameter, select between the following functions:

Digital input off.

- Input
- HW gate (see chapter "Gate function in the case of fast mode (Page 198)")
- Synchronization on positive edge (see chapter "Synchronization (Page 199)")
- HW enable for synchronization (see chapter "Synchronization (Page 199)")

3.8.3 Gate function in the case of fast mode

Hardware Gate

The 1Count5V has a HW gate, which can be controlled via the digital input on the 1Count5V.

You assign the hardware gate as the function of the digital input (Function DI "HW Gate"). It is opened on a positive edge at the digital input and closed on a negative edge.

If no HW gate is assigned, counting becomes active immediately.

The STS_GATE checkback signal indicates whether counting is active.

When the HW gate is opened, this causes counting to continue starting from the current count.

3.8.4 Synchronization

Introduction

In order to use this function, you must first select it with the "Synchronize on Positive Edge" Function DI parameter.

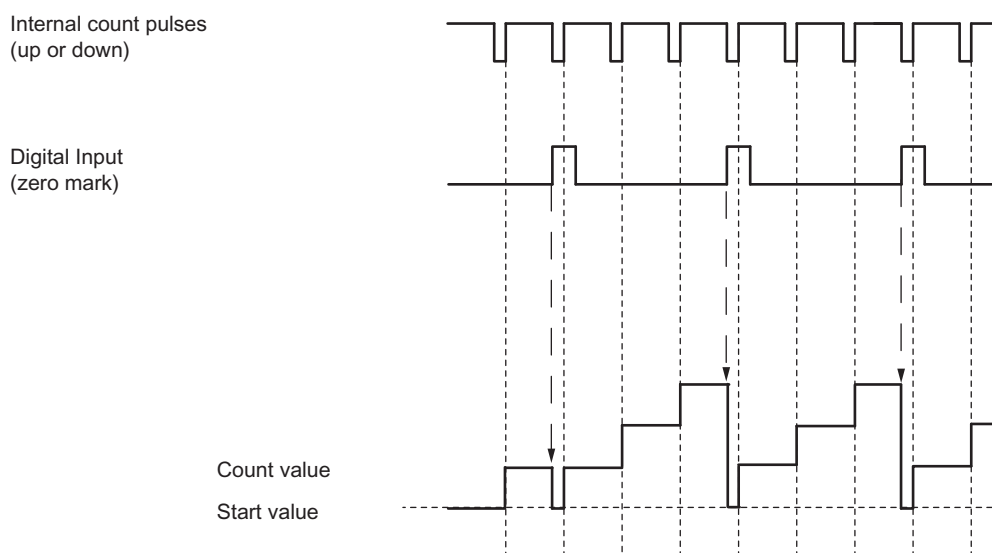

If you have assigned synchronization, the positive edge of a reference signal on the input sets the 1Count5V to the start value.

The following conditions apply:

- Fast mode must be active (HW gate).
 - When synchronization is activated, the first edge and each additional edge loads the 1Count5V with the start value.
- The signal of a bounce-free switch or the zero mark of a rotary encoder can serve as the reference signal.
- The STS_DI feedback bit indicates the level of the reference signal.

Synchronization with DI and Zero Mark

In order to use this function, you must first select it with the "HW enable for synchronization" Function DI parameter.

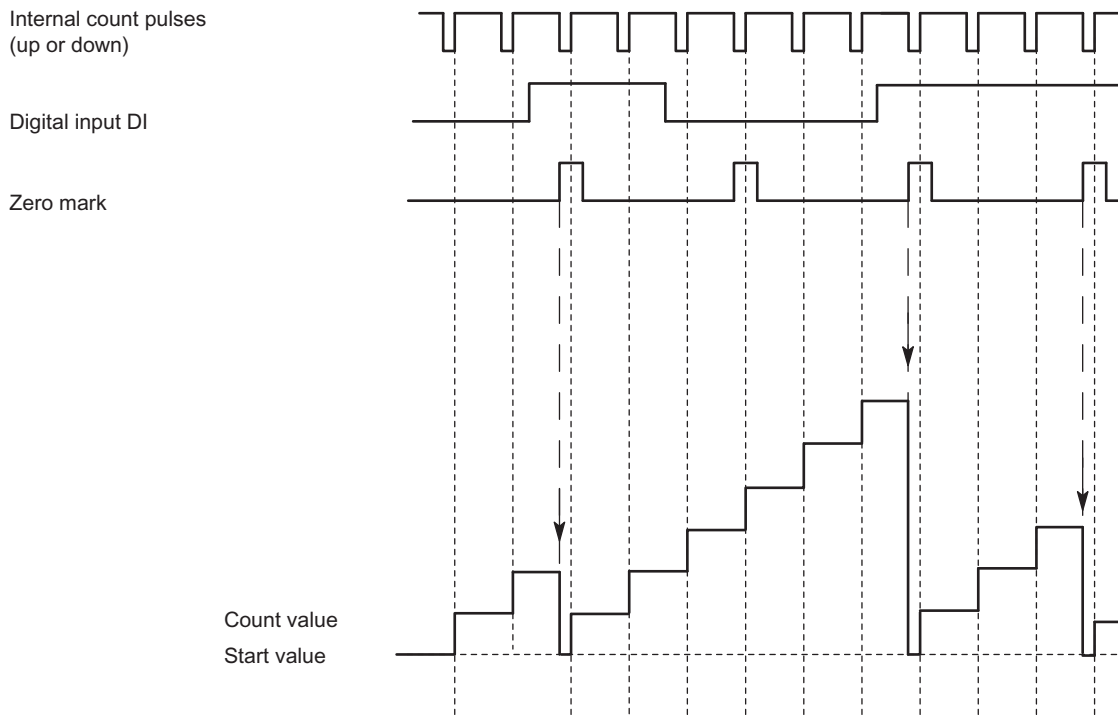

If you have assigned synchronization with DI and zero mark, the DI serves as the HW enable. When the HW enable is active, the 1Count5V is loaded with the load value by the zero mark of the encoder.

3.8.5 Assignment of feedback interface for fast mode

Note

For the 1Count5V, the following data of the feedback interface are consistent:

- Bytes 0 to 3

Use the access or addressing mode for data consistency over the entire control and feedback interface on your master (only for configuration using the GSD file).

Assignment Tables

Address	Assignment	Name	
Bytes 0 to 3	Bit 31	Sign of life	LZ
	Bit 30	Isochronous mode applied	STS_TIC
	Bit 29	Parameter Assignment Error	ERR_PARA
	Bit 28	Group error <ul style="list-style-type: none"> • Encoder supply short circuit • Short circuit / wire break / encoder signal 	EXTF
	Bit 27	DI status	STS_DI
	Bit 26	Status of direction up/down	STS_DIR
	Bit 25	Status of (internal) gate	STS_GATE
	Bits 0 to 24	Count value	

Notes on the Feedback Bits

Feedback bit	Notes
LZ	The sign of life is toggled on each update of the feedback interface, i.e. the last sent value is inverted.
STS_TIC	Isochronous mode (if assigned) was applied.
ERR_PARA	The assigned module parameters are faulty.
EXTF	Group error Possible causes: <ul style="list-style-type: none"> • Encoder supply short circuit • Short circuit or encoder signal wire break EXTF is reset when the causes of the errors are eliminated.
STS_DI	The bit displays the status of the digital input DI.
STS_DIR	Status of direction; for encoder value change from larger to smaller encoder positions (including zero crossover) → "1 " for encoder value change from larger to smaller encoder positions (including zero crossover) → "0 "
STS_GATE	Status of (internal) gate: Counting

Access to the Feedback Interface in STEP 7 Programming

	Configuring with STEP 7 using HW Config
Feedback interface	Load command, e.g. L PID

Error Detection in Fast Mode

The encoder supply short circuit and short circuit/encoder signal wire break faults are detected by the 1Count5V and indicated in the feedback interface (EXTF).

The error display in the feedback interface is cleared as soon as this error is no longer detected by the 1Count5V.

The parameter error bit (ERR_PARA) is acknowledged by means of a correct parameter assignment.

3.8.6 Assigning parameters for fast mode

Introduction

You use the following to assign parameters for the 1Count5V:

- STEP 7 Version 5.4 or higher; if necessary, the HSP (hardware support package) must be downloaded from the Internet

Parameter List for Fast Mode

Parameter	Value Range	Default
Response to failure of the higher-level controller		
Response to CPU/Master STOP	Stop operating mode Continue operating mode	Stop operating mode
Basic parameters		
Diagnostics A and B	Off/on	Off
Diagnostics N	Off/on	Off
Signal evaluation A, B	Rotary encoder single/double/quadruple	Rotary encoder single
Direction input B	Normal/inverted	Normal
Mode		
Fast mode	Fast mode	Fast mode
Gate function	Cancel counting/ Interrupt counting	Cancel counting
Input signal HW gate	Normal/inverted	Normal
Function DI	Input / HW gate/ Synchronization at positive edge/ HW enable for synchronization	Input
Load value	-16777216 ... +16777215	0

Parameter assignment error

- The "Input signal HW gate" parameter is set to inverted and the "Function DI" parameter is not set to HW gate.

What to Do in the Event of Errors

Check the set value ranges.

3.9 Position feedback

3.9.1 Overview

Description

This mode encompasses a subset of the functionality of the continuous counting mode. It is intended for isochronous mode and differs from continuous counting by a smaller T_{DP} Module_{min} and a T_{WA} equal to zero. This T_{WA} equal to zero makes it possible to operate the module as an input module only. In this case, however, the possible controls are no longer synchronized with T_o but rather are executed in the T_{DP} cycle before or after T_i .

To run this mode, you have to assign parameters to the 1Count5V (see section "Assigning Parameters for Position Feedback (Page 221)").

Maximum Count Range

The high counting limit is +2147483647 ($2^{31} - 1$).

The low counting limit is -2147483648 (-2^{31}).

Load value

You can specify a load value for the 1Count5V.

This load value is either applied directly as the new count value (LOAD_VAL) or it is applied as the new count value when the following events occur (LOAD_PREPARE):

- The counting operation is started by a SW gate or HW gate (if the counting operation is continued, the load value is not applied).
- Synchronization
- Latch and retrigger

Gate Control

To control the 1Count5V, you have to use the gate functions.

RESET States of the Following Values after Parameter Assignment

Table 3- 21 RESET States

Value	RESET state
Load value	0
Count value	0
Latch value	0

Isochronous mode

In isochronous mode, the 1Count5V accepts control bits and control values from the control interface in each bus cycle and reports back the response in this mode in the same cycle or in the next cycle.

In each cycle, the 1Count5V transfers the count or latch value that was valid at time T_i and the status bits valid at time T_i .

A count controlled by hardware input signals can only be transferred in the same cycle if the input signal occurred before time T_i .

3.9.2 Position detection

Definition

In this mode, the 1Count5V counts continuously starting from the load value:

- If the 1Count5V reaches the high count limit when counting up, and another count pulse then comes, it will jump to the low count limit and continue counting from there without losing a pulse.
- If the 1Count5V reaches the low count limit when counting down, and another count pulse then comes, it will jump to the high count limit and continue counting from there without losing a pulse.
- The high counting limit is set at $+2147483647$ ($2^{31} - 1$).
- The low counting limit is set to -2147483648 (-2^{31}).

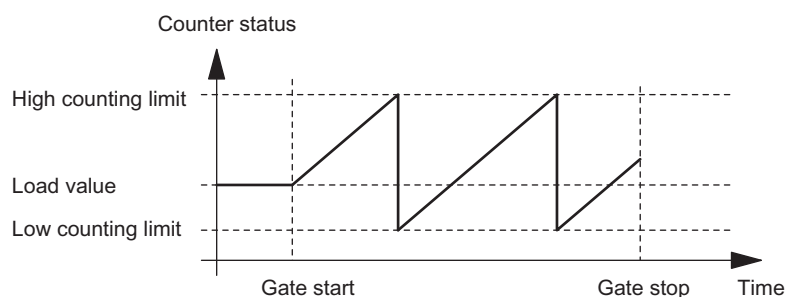

Figure 3-35 Count Continuously with Gate Function

Function of the Digital Input

For the "Function DI" parameter, select one of the following functions for the digital input:

- Input
- HW gate (see section "Gate Functions for Position Detection (Page 207)")
- Latch function (see section "Latch Function (Page 210)")
- Synchronization (see section "Synchronization (Page 213)")
- HW enable for synchronization (see section "Synchronization (Page 213)")

3.9.3 Gate Functions for Position Detection

Software Gate and Hardware Gate

The 1Count5V has two gates

- A software gate (SW gate), which is controlled by the SW_GATE control bit.

The software gate can only be opened by a positive edge of the SW_GATE control bit. It is closed when this bit is reset. Note the transfer times and run times of your control program.

- A hardware gate (HW gate), which is controlled by means of the digital input on the 1Count5V.

You assign the hardware gate as the function of the digital input (Function DI "HW Gate"). It is opened on a positive edge at the digital input and closed on a negative edge.

Internal Gate

The internal gate is the logical AND operation of the HW gate and SW gate. Counting is only active when the HW gate and the SW gate are open. The STS_GATE feedback bit (internal gate status) indicates this. If a HW gate has not been assigned, the setting of the SW gate is decisive. Counting is activated, interrupted, continued, and canceled by means of the internal gate.

Canceling- and Interrupting-Type Gate Function

When assigning the gate function, you can specify whether the internal gate is to cancel or interrupt counting. When counting is canceled, after the gate is closed and restarted, counting starts again from the beginning. When counting is interrupted, after the gate is closed and restarted, counting continues from the previous value.

The diagrams below indicate how the interrupting and canceling gate functions work:

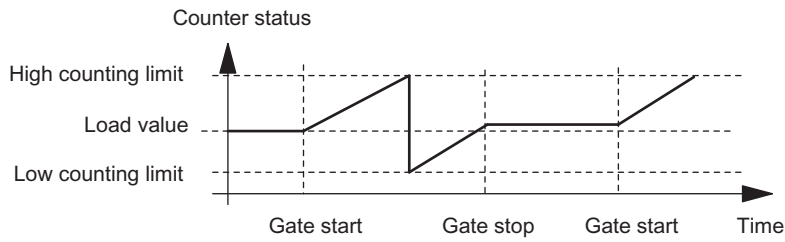

Figure 3-36 Position Detection, Up, Interrupting Gate Function

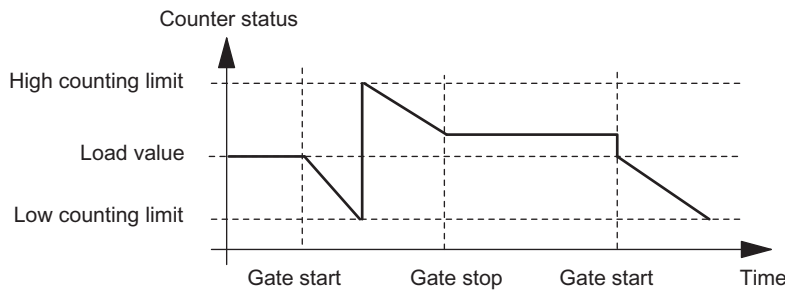

Figure 3-37 Position Detection, Down, Interrupting Gate Function

Gate Control

Gate control by means of the SW gate only

When the gate is opened, one of the following occurs, depending on the parameter assignment:

- Counting continues from the current count, or
- Counting starts from the load value

If the SW gate is opened in isochronous mode in bus cycle "n" by setting the SW_GATE control bit, counting starts before or after T_i , depending on the position of T_i .

Gate control by means of the SW gate and HW gate

If the SW gate opens when the HW gate is already open, counting continues starting from the current count.

When the HW gate is opened, one of the following occurs, depending on the parameter assignment:

- Counting continues from the current count

or

- Counting starts from the load value

If the SW gate is opened in isochronous mode in bus cycle "n" by setting the SW_GATE control bit, counting starts in cycle "n+1" before or after T_i , if the HW gate is already open at this time. If the HW gate opens after the SW gate has been opened, then counting does not start until the HW gate opens.

3.9.4 Latch Function

Overview

There are two latch functions:

- The Latch and Retrigger function
- The Latch function

The Latch and Retrigger Function

In order to use this function, you must first select it with the "Latch and Retrigger on Positive Edge" Function DI parameter.

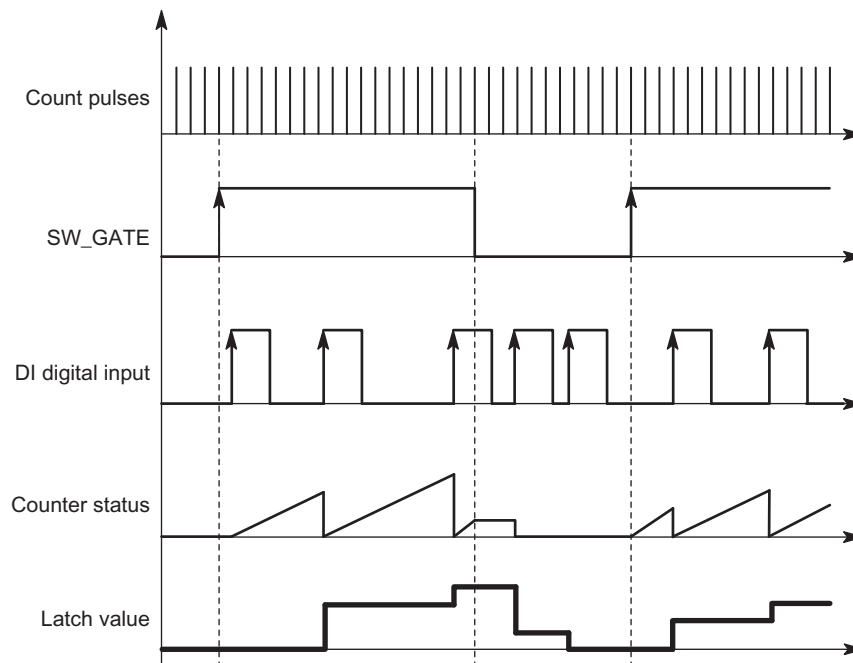

Figure 3-38 Latch and Retrigger with Load Value = 0

This function stores the current internal counter status of the 1Count5V and retriggers counting when there is a positive edge on the digital input. This means that the current internal counter status at the time of the positive edge is stored (latch value), and the 1Count5V is then loaded again with the load value, from which counting resumes.

The counting mode must be enabled with the SW gate before the function can be executed. It is started with the first positive edge on the digital input.

The stored counter status rather than the current counter status is indicated in the feedback interface. The STS_DI bit indicates the status of the latch and retrigger signal.

The latch value is preassigned with its RESET state (see corresponding table). It is not changed when the SW gate is opened.

Direct loading of the counter does not cause the indicated stored counter status to be changed.

If you close the SW gate, it only interrupts counting; this means that when you open the SW gate again, counting is continued. The digital input DI remains active even when the SW gate is closed.

Counting is also latched and triggered in isochronous mode with each edge on the digital input. The counter status that was valid at the time of the last edge before T_i is displayed in the feedback interface.

The Latch function

In order to use this function, the Function DI parameter "Latch on Positive Edge" must be selected for the digital input.

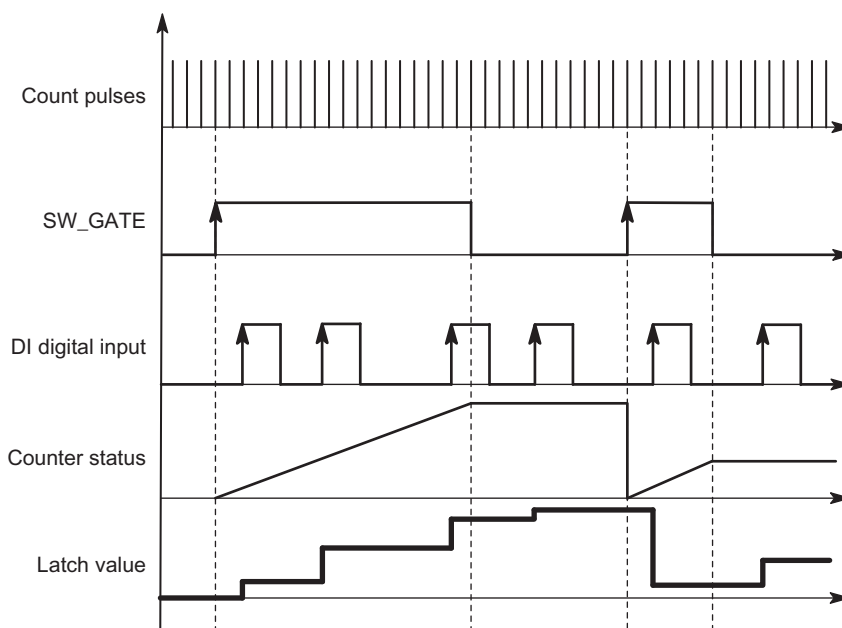

Figure 3-39 Latch with a Load Value of 0

Counter status and latch value are preset with their RESET states (see corresponding table).

The counting function is started when the SW gate is opened. The 1Count5V begins at the load value.

The latch value is always the exact counter status at the time of the positive edge on the digital input DI.

The stored counter status rather than the current counter status is indicated in the feedback interface. The STS_DI bit indicates the level of the latch signal.

Direct loading of the counter does not cause the indicated stored counter status to be changed.

In isochronous mode, the counter status that was latched at the time of the last positive edge before T_i is displayed in the feedback interface.

When you close the SW gate, the effect is either canceling or interrupting, depending on the parameter assignment. The digital input DI remains active even when the SW gate is closed.

Expanded Feedback Interface

If the 1Count5V is inserted behind an IM 151 that supports the reading and writing of broader user data interfaces, the current count value can be read from bytes 8 to 11 of the feedback interface.

3.9.5 Synchronization

Synchronization

In order to use this function, you must first select it with the "Synchronize on Positive Edge" Function DI parameter.

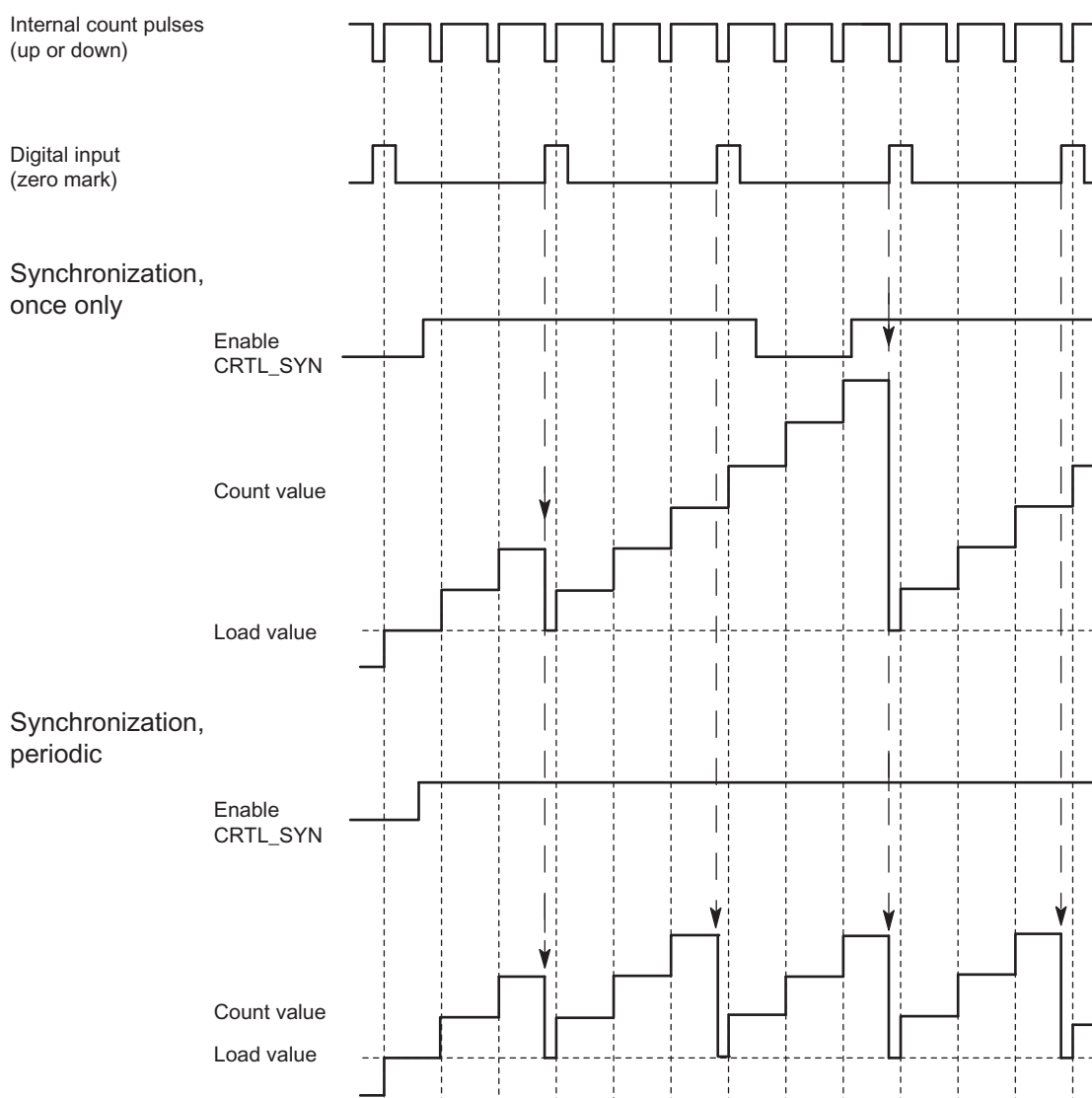

Figure 3-40 Once-Only and Periodic Synchronization

If you have configured synchronization, the positive edge of a reference signal on the input sets the 1Count5V to the load value.

You can select between once-only and periodic synchronization ("Synchronization" parameter).

The following conditions apply:

- The counting mode must have been started with the SW gate.
- The "Enable synchronization CTRL_SYN" control bit must be set.
- Synchronize once only: If the enable bit is set, the first edge loads the 1Count5V with the load value.
- Synchronization periodically: If the enable bit is set, the first and every further edge loads the 1Count5V with the load value.
- After successful synchronization, the STS_SYN feedback bit is set. It must be reset by the RES_STS control bit.
- The signal of a bounce-free switch or the zero mark of a rotary encoder can serve as the reference signal.
- The STS_DI feedback bit indicates the level of the reference signal.

In isochronous mode, the set feedback bit STS_SYN indicates that the positive edge on the digital input was between time T_i in the current cycle and T_i in the previous cycle.

3.9.6 Assignment of the Feedback and Control Interface for Position Feedback

Note

For the 1Count5V, the following data of the control and feedback interface are consistent:

Bytes 0 to 3

Bytes 4 to 7

Bytes 8 to 11 (modified user data interface)

Use the access or addressing mode for data consistency over the entire control and feedback interface on your master (only for configuration using the GSD file).

Assignment Tables

Table 3- 22 Feedback Interface (Inputs)

Address	Assignment	Designation
Bytes 0 to 3	Count value or stored count value in the case of the latch function on the digital input	
Byte 4	Bit 7: Short circuit of the encoder supply Bit 6: Reserve = 0 Bit 5: Parameter assignment error Bit 4: Reserve = 0 Bit 3: Reserve = 0 Bit 2: Resetting of status bits active Bit 1: Load function error Bit 0: Load function is running	ERR_24V ERR_PARA RES_STS_A ERR_LOAD STS_LOAD
Byte 5	Bit 7: Down direction status Bit 6: Up direction status Bit 5: Reserve = 0 Bit 4: Reserve = 0 Bit 3: Reserve = 0 Bit 2: Reserve = 0 Bit 1: DI status Bit 0: Internal gate status	STS_C_DN STS_C_UP STS_DI STS_GATE
Byte 6	Bit 7: Zero crossing Bit 6: Low counting limit Bit 5: High counting limit Bit 4: Reserve = 0 Bit 3: Reserve = 0 Bit 2: Reserve = 0 Bit 1: Reserve = 0 Bit 0: Synchronization status	STS_ND STS_UFLW STS_OFLW STS_SYN
Byte 7	Reserve = 0	
Bytes 8 to 11	Count value ¹	

¹ Modified user data interface

Table 3- 23 Control Interface (Outputs)

Address	Designation	Assignment	
Bytes 0 to 3		Load value direct, preparatory, comparison value 1 or 2	
Byte 4	EXTF_ACK RES_STS CTRL_SYN SW_GATE	Bit 7: Bit 6: Bit 5: Bit 4: Bit 3: Bit 2: Bit 1: Bit 0:	Error diagnostics acknowledgment Reserve = 0 Reserve = 0 Reserve = 0 Reserve = 0 Start resetting of status bit Enable synchronization SW gate control bit
Byte 5	LOAD_PREPARE LOAD_VAL	Bit 7: Bit 6: Bit 5: Bit 4: Bit 3: Bit 2: Bit 1: Bit 0:	Reserve = 0 Reserve = 0 Reserve = 0 Reserve = 0 Reserve = 0 Reserve = 0 Load counter preparatory Load counter direct
Bytes 6 to 7		Reserve = 0 ¹	
¹ Not used for modified user interface			

Notes on the Control Bits

Table 3- 24 Notes on the Control Bits

Control bits	Notes
CTRL_SYN	You use this bit to enable synchronization.
EXTF_ACK	Error acknowledgment The error bits must be acknowledged with the EXTF_ACK control bit after the cause is removed.
LOAD_PREPARE	Load counter preparatory The value from bytes 0 to 3 is applied as the load value.
LOAD_VAL	The value from bytes 0 to 3 is loaded directly as the new count value.
RES_STS	Start resetting of status bit The status bits are reset by means of the acknowledgment process between the RES_STS bit and the RES_STS_A bit.
SW_GATE	SW gate control bit The SW gate is opened/closed by means of the control interface with the SW_GATE bit.

Notes on the Feedback Bits

Table 3- 25 Notes on the Feedback Bits

Feedback Bits	Notes
ERR_24V	Short circuit of the encoder supply The error bit must be acknowledged by the EXTF_ACK control bit. Diagnostic message if assigned.
ERR_LOAD	Load function error The LOAD_VAL, LOAD_PREPARE, CMP_VAL1, CMP_VAL2, and C_DOPARAM bits cannot be set simultaneously during transfer. This results in setting the ERR_LOAD status bit, similar to loading an incorrect value (which is not accepted).
ERR_PARA	Parameter assignment error ERR_PARA
RES_STS_A	Resetting of status bits active
STS_C_DN	Down direction status
STS_C_UP	Up direction status
STS_DI	DI status The status of the DI is indicated in all modes with the STS_DI bit in the feedback interface.
STS_GATE	Internal gate status: Counting
STS_LOAD	Load function is running
STS_ND	Zero-crossing in the count range when counting without a main counting direction. The bit must be reset by the RES_STS control bit.
STS_OFLW	High counting limit violated
STS_UFLW	Low counting limit violated
	Both bits must be reset.
STS_SYN	Synchronization status After successful synchronization, the STS_SYN bit is set. It must be reset by the RES_STS control bit.

Access to the Control and Feedback Interface in STEP 7 Programming

Table 3- 26 Access to the Control and Feedback Interface in STEP 7 Programming

	Configuring with STEP 7 using the GSD file ¹⁾ (Hardware catalog\PROFIBUS-DP\Additional FIELD DEVICES\OET 200S)	Configuring with STEP 7 using HW Config (Hardware catalog\PROFIBUS- DP\OET 200S)
Feedback interface	Read with SFC 14 "DPRD_DAT"	Load command (e.g. L PID)
Control interface	Write with SFC 15 "DPWR_DAT"	Transfer command (e.g. T PQD)
¹ Load and transfer commands are also possible with CPU 3xxC, CPU 3xx with MMC, CPU 4xx (V3.0 and later), and WinLC RTX (PC CPU).		

Resetting of the Status Bits
STS_SYN, STS_OFLW, STS_UFLW, STS_ND

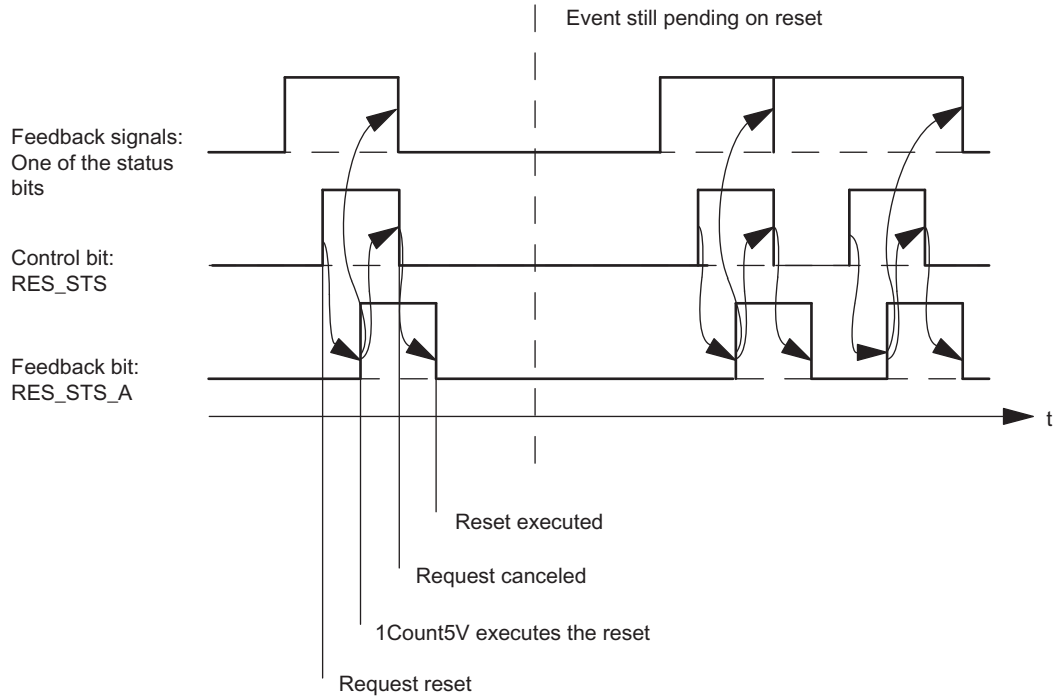

Figure 3-41 Resetting of the Status Bits

Acceptance of Values with the Load Function

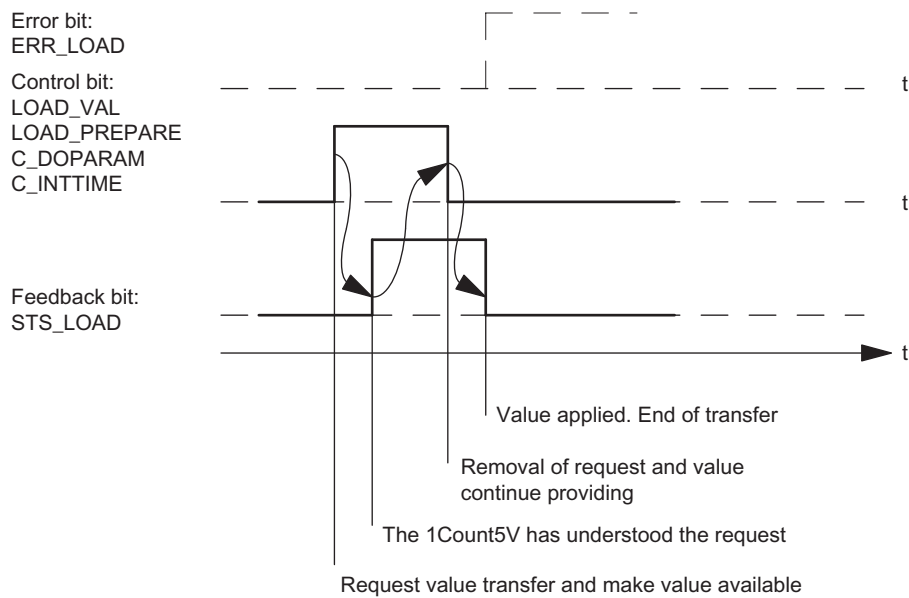

Figure 3-42 Accepting Values with the Load Function (LOAD_VAL; LOAD_PREPARE; C_DOPARAM; C_INTTIME)

Note

Only one of the following control bits can be set at a particular time:

LOAD_VAL or LOAD_PREPARE.

Otherwise, the ERR_LOAD error is reported until all the specified control bits are deleted again.

The ERR_LOAD error bit is only deleted when the following is carried out correctly.

Acknowledgment Principle in Isochronous Mode

In isochronous mode, 4 or 6 bus cycles are required to reset the status bits and to accept values during the load function in this mode.

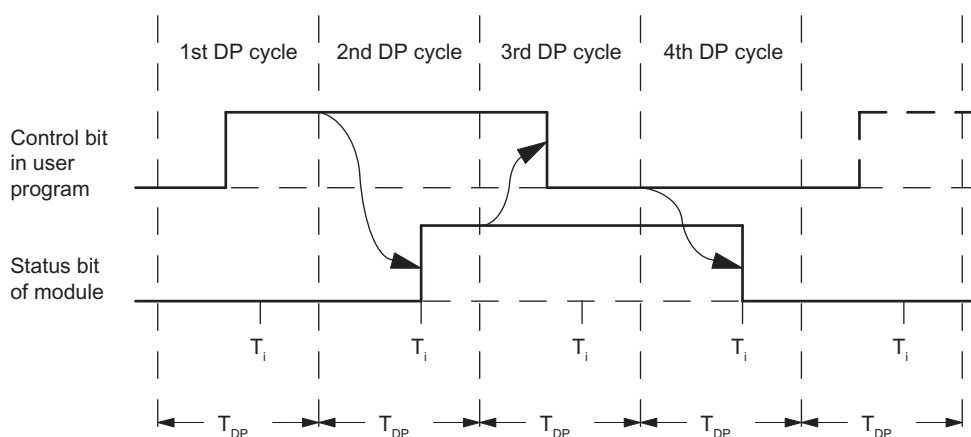

Figure 3-43 Acknowledgment Principle in Isochronous Mode

Error Detection

The program errors must be acknowledged. They have been detected by the 1Count5V and are indicated at the feedback interface. Channel-specific diagnostics are performed if you have enabled group diagnostics in your configuration (see device manual of the interface module used).

The parameter assignment error bit is acknowledged by means of correct parameter assignment.

An error has occurred, the 1Count5V sets an error bit, a diagnostic message may appear, error detection continues

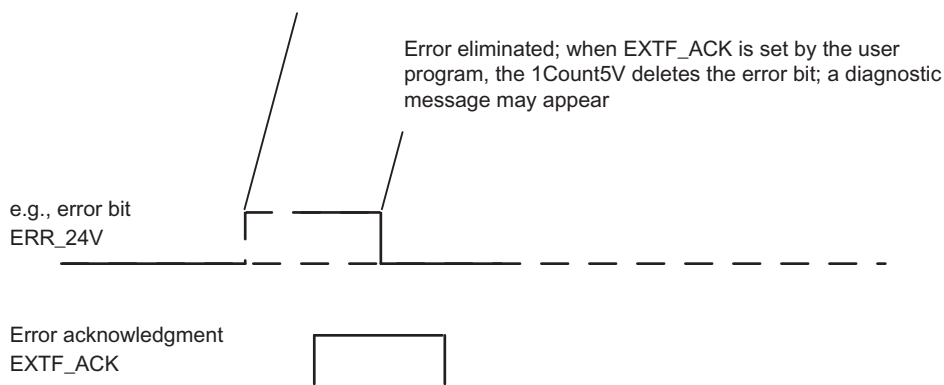

Figure 3-44 Error Acknowledgment

In the case of constant error acknowledgement (EXTF_ACK = 1) or in CPU/master STOP mode, the 1Count5V reports the errors as soon as they are detected and clears the errors as soon as they are eliminated.

3.9.7 Assigning Parameters for Position Feedback

Introduction

You can use either of the following to assign parameters for the 1Count5V:

- STEP 7 V5.3 SP2 or later
- A GSD file (<http://www.automation.siemens.com/csi/gsd>)

Parameter list for Position Feedback

Table 3- 27 Parameter list for Position Feedback

Parameter	Value Range	Default
Enable		
Group diagnostics	Disable/enable	Disable
Response to failure of the higher-level controller		
Response to CPU/Master STOP	Turn off Continue working mode	Turn off
Encoder parameters		
Diagnostics A and B	Off/on	Off
Diagnostics N	Off/on	Off
Signal evaluation A, B	Rotary encoder single/double/quadruple	Rotary encoder single
Direction input B	Normal/inverted	Normal
Mode		
Position feedback	Position detection	Position detection
Gate function	Cancel counting/ Interrupt counting	Cancel counting
Input signal HW gate	Normal/inverted	Normal
Function DI	Input / HW gate / Latch and retrigger at positive edge / Synchronization at positive edge / HW enable for synchronization / Latch at positive edge	Input
Synchronization ¹	Once only/Periodic	Once-only
¹ Only relevant if Function DI = Synchronization at positive edge		

Parameter assignment error

- The "Input signal HW gate" parameter is set to inverted and the "Function DI" parameter is not set to HW gate.

What to Do in the Event of Errors

Check the set value ranges.

3.10 Evaluation of count and direction signal

Signal Evaluation A, B

Signal evaluation by means of A, B allows you to count directionally. Different evaluation modes are possible depending on the parameter assignment:

Rotary Encoder

The 1Count5V can count the edges of the signals. Normally, only the edges at A are evaluated (single evaluation). To obtain a higher resolution, when assigning parameters ("Signal Evaluation" parameter), you can select whether the signals are to be subjected to single, double, or quadruple evaluation.

Multiple evaluation is only possible with asymmetric incremental encoders with A and B signals that are 90 degrees out of phase.

Single Evaluation

Single evaluation means that only one edge of A is evaluated; up count pulses are recorded at a positive edge at A and low level at B, and down count pulses are recorded at a negative edge at A and low level at B.

The diagram below illustrates the single evaluation of the signals.

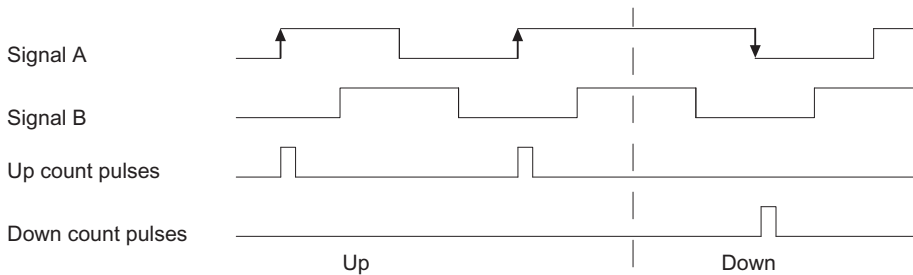

Figure 3-45 Single Evaluation

Double Evaluation

Double evaluation means that the positive and negative edge of the A signal are evaluated. Whether up or down count pulses are generated depends on the level of the B signal.

The diagram below illustrates the double evaluation of the signals.

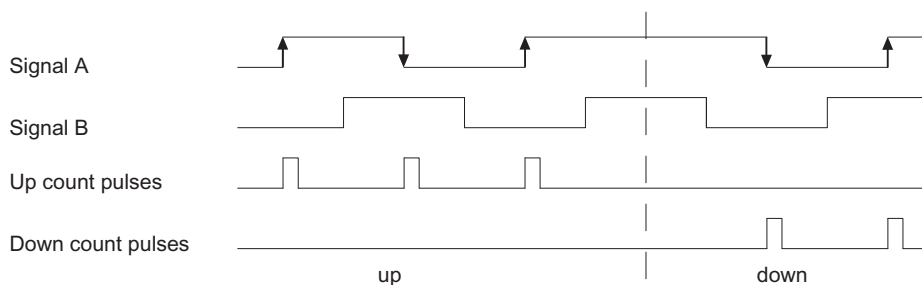

Figure 3-46 Double Evaluation

Quadruple Evaluation

Quadruple evaluation means that the positive and negative edges of the A and B signals are evaluated. Whether up or down count pulses are generated depends on the levels of the A and B signals.

The diagram below illustrates the quadruple evaluation of the signals.

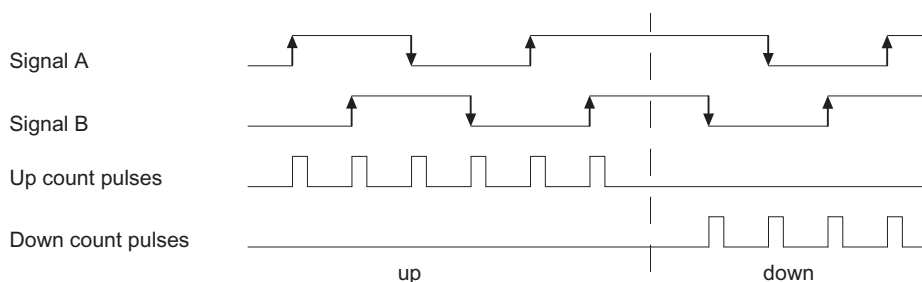

Figure 3-47 Quadruple Evaluation

Note

A counting frequency of 500 KHz refers to the maximum frequency of the A and B signals. With double evaluation, a maximum frequency of 1 MHz is produced for the counting pulses; with quadruple evaluation, the maximum frequency is 2 MHz.

3.11 Diagnostics

3.11.1 Diagnostics using the LED display

LED display on the 1Count5V

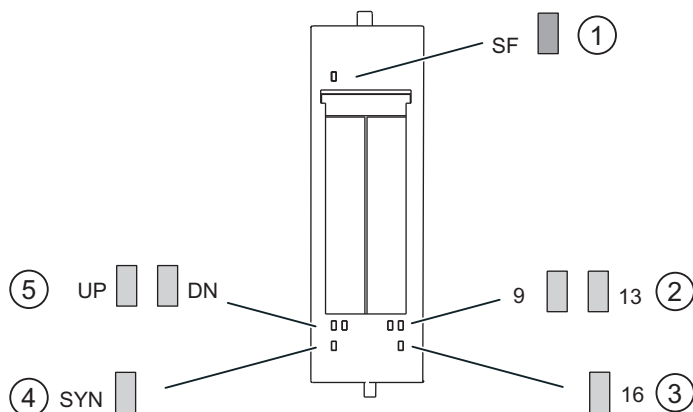

- ① Group error (red)
- ② Status display for the digital output (green)
- ③ Status display for digital input (green)
- ④ Status display for synchronization (green)
- ⑤ Status display for counting direction (green)

Status and error displays by means of LEDs on the 1Count5V

The table below shows the status and error displays on the 1Count5V.

Event (LEDs)							Cause	Remedy
SF	UP	DN	SYN	9	13	16		
On							No parameter assignment. There is a diagnostic message.	Check the parameter assignment. Evaluate the diagnostics data.
	On						Status of the low-order bits of the counter, if the counter counts up.	
		On					Status of the inverse low-order bits of the counter, if the counter counts down.	
			On				Synchronization is performed (only in counting modes; image of STS_SYN acknowledgement bit).	
				On			DO 1 is activated.	
					On		DO 2 is activated.	
						On	DI is activated.	

3.11.2 Error types

For information on the structure of the channel-related diagnostics, refer to the manual on the interface module used in your ET 200S station.

1Count5V error types

The following table shows the error types on the 1Count5V.

Error class		Meaning	Remedy
1 _D	00001: Short circuit	Short circuit of the sensor supply or the actuator.	Check the wiring to the sensor. Correct the process wiring.
5 _D	00101: Overtemperature	The digital output is overloaded.	Correct the process wiring.
6 _D	00110: Wire break	Line to the actuator is interrupted.	Correct the process wiring.
9 _D	01001: Error	Internal module error occurred.	Replace the module.
16 _D	10000: Parameter assignment error	Parameters have not been assigned to the module.	Correct the parameter assignment.
26 _D	11010: External error	Wire break/short circuit of the 5 V sensor signals: A, /A, B, /B, N, /N,	Correct the parameter assignment.

3.12 Behavior at CPU-Master-STOP

Setting the response to CPU/master STOP

You can configure the reaction of the 1Count5V to failure of the higher-level controller.

Parameters	Status of the 1Count5V at CPU/master STOP	What Happens if New Parameters Have Been Assigned?
Turn off DO	The current mode is terminated, the gate closed, and the digital output blocked; comparison values 1 and 2 and the load value are reset; the high and low limit values, function and behavior of the digital outputs and the integration time are handled in accordance with the parameter assignments.	The changed parameters are accepted and take effect.
Continue working mode ¹	The current mode continues, and the gate and digital output retain their status.	The gate is closed, the current mode is terminated, the digital output is blocked, and the changed parameters are accepted and take effect.
DO substitute a value	The current mode is canceled, the gate closed, and the digital output blocked; comparison values 1 and 2 and the load value are reset; the high and low limit values, function and behavior of the digital outputs and the integration time are handled in accordance with the parameter assignments. When a pulse is output when the comparison value is reached, the substitute value is 1 only for the duration of the pulse.	The changed parameters are accepted and take effect.
DO keep last value	The current mode is canceled, the gate closed, and the digital output blocked; comparison values 1 and 2 and the load value are reset; the high and low limit values, function and behavior of the digital outputs and the integration time are handled in accordance with the parameter assignments.	The changed parameters are accepted and take effect.
¹ If the mode is to continue during a change from CPU-/Master-STOP to RUN (startup), the CPU/Master must not clear the outputs. Possible solution: In the part of the user program that is executed during startup, set the SW gate control bit and transfer the values to the 1Count5V.		

Leaving the Assigned State

Under what conditions does the 1Count5V leave the assigned state?

The CPU or master must be in RUN mode, and you have to make a change at the control interface.

Automatic New Parameter Assignment

A new parameter assignment of the ET 200S station is made by your CPU/ DP master:

- Upon power on of the CPU/DP master
- Upon power on of the IM 151/IM 151 FO
- After failure of the DP transmission
- After loading a modified parameter assignment or configuration of the ET 200S station to the CPU/DP master
- When the 1Count5V is plugged
- Upon power on or inserting of the appropriate power module

3.13 Technical Specifications

Technical specifications

General technical specifications of the 1Count5V	
Dimensions and Weight	
Dimensions W x H x D (mm)	30×81×52
Weight	Approx. 65 g
Data for Specific Modules	
Number of Channels	1
Counter range	32 bits
Voltages, Currents, Potentials	
Rated load voltage L+	24 VDC
• Reverse polarity protection	Yes
Galvanic isolation	
• Between backplane bus and counter function	Yes
• Between counter function and load voltage	No
Encoder supply	
• Output voltage	L+ (-0.8 V)
• Output current	Max. 500 mA (Total current at terminals 2, 11 and 15), short circuit proof
Current consumption	
• From the backplane bus	max. 10 mA
• From load voltage L+ (no load)	45 mA, typical
Power dissipation	Typ. 2 W
Data for the Digital Input	
Galvanic isolation	No, only from shield and backplane bus
Input voltage	
• Rated value	24 VDC
• 0 signal	-30 V to 5 V
• 1 signal	11 V to 30 V
Input current	
• 0 signal	≤2 mA (quiescent current)
• 1 signal	9 mA (typically)
Minimum pulse width	2.5 μs
Connection of a two-wire BERO type 2	Possible
Input characteristic	In accordance with IEC 1131, Part 2, Type 2
Shielded cable length	50 m, maximum

General technical specifications of the 1Count5V	
Encoder Signals	
Level	In accordance with RS 422
Terminating resistance	330 Ω
Differential input voltage	1 V, minimum
Maximum counting frequency	500 kHz
Galvanic isolation from ET200S bus	Yes
Shielded cable length	50 m, maximum
Data for the Digital Outputs	
Output voltage <ul style="list-style-type: none"> • Rated value • 0 signal • 1 signal 	24 VDC $\leq 3V$ $\geq L+ (-1V)$
Output current <ul style="list-style-type: none"> • 0 signal (residual current) • 1 signal <ul style="list-style-type: none"> – Permitted range – Rated value 	$\leq 0.5 \text{ mA}$ 5 mA to 2.4 A 2A
Switching frequency <ul style="list-style-type: none"> • Resistive load • Inductive load • Lamp load 	100 Hz 2 Hz $\leq 10 \text{ Hz}$
Lamp load	$\leq 10 \text{ W}$
Output delay (resistive load)	100 μs
Short circuit protection for output	Yes
Response threshold	2.6 A to 4 A
Inductive extinction	Yes; L+ -(50 to 60 V)
Digital input control	Yes
Cable lengths <ul style="list-style-type: none"> • Unshielded • Shielded 	600 m 1000 m
Status, Diagnostics	
Digital input DI status display	LED 16 (green)
Digital output DO1 status display	LED 9 (green)
Digital output DO2 status display	LED 13 (green)
Up count value change	UP LED (green)
Down count value change	DN LED (green)
Synchronization	SYN LED (green)
Fault indicator	SF LED (red)
Diagnostic information	Yes

3.13 Technical Specifications

General technical specifications of the 1Count5V	
Measuring Ranges in the Measuring Modes	
Maximum measuring range <ul style="list-style-type: none"> • Frequency measurement • Rotational Speed Measurement • Period measurement 	0.1 Hz to 500 kHz 1/min ... 25000 /min 10 µs ... 120 s
Response Times	
Update rate of the counting modes <ul style="list-style-type: none"> • Non-isochronous mode • Isochronous mode 	1 ms T _{DP}
Isochronous Times of the Module	
in counting modes <ul style="list-style-type: none"> TCI TCO T_{oi}Min T_{DP}Min 	380 µs 320 µs 55 µs 900 µs
in measuring modes <ul style="list-style-type: none"> TCI TCO T_{oi}Min T_{DP}Min 	465 µs 280 µs 50 µs 995 µs
in position feedback <ul style="list-style-type: none"> TCI TCO T_{oi}Min T_{DP}Min 	370 µs 0 µs 0 µs 815 µs

4.1 Product Overview

Order Number

6ES7 138-4DB03-0AB0

Compatibility

The 1SSI with order number 6ES7 138-DB03-0AB0 replaces the 1SSI with the following order numbers:

- 6ES7 138-4DB02-0AB0
- 6ES7 138-4DB01-0AB0
- 6ES7 138-4DB00-0AB0

and is fully compatible.

Features

- The 1SSI is an interface between an absolute encoder (SSI) and the higher-level controller. You edit the cyclically recorded encoder value in your controller program.
- Can be operated using terminal modules TM-E15S24-01 and TM-E15S26-A1
- Isochronous mode
- Normalization of the encoder value (that is, discounting of adjusted, irrelevant bits in the encoder value).
- Reversal of the direction of rotation to adjust the direction of movement of the absolute encoder to the axis.
- Latch function for freezing the current encoder value (only possible in standard mode).
- Comparison function between the current encoder value and loadable comparison values (only possible in standard mode).
- Type of encoder value recording can be selected:
 - Free-wheeling
 - Synchronous to the update rate
 - Isochronously
- Fast mode can be selected; with rapid encoder value detection and compressed functionality (cannot be used with the IM 151 with the order number 6ES7 151-1AA00-0AB0).
- Maximum encoder sampling rate (e.g., for ultrasonic encoders) is taken into account in isochronous mode
- Sign of life in isochronous mode
- Parity check of encoder value can be performed
- Gray/dual converter

Supported Encoder Types

The following encoder types are supported:

- Absolute encoder (SSI) with 13 bits
To
- Absolute encoder (SSI) with 25 bits

Note

The predecessor modules only support absolute encoders (SSI) that have widths of 13 bits, 21 bits and 25 bits.

Firmware update ¹

To add functions and for troubleshooting, you can load firmware updates to the operating system memory of the 1SSI using STEP 7 HW Config.

Note

When you start the firmware update, the old firmware is deleted. If the firmware update is interrupted or canceled for any reason, the 1SSI will no longer function correctly as a result. Restart the firmware update and wait until it has completed successfully.

Identification Data ¹

- Hardware release status
- Serial number

See also ET 200S Distributed I/O operating instructions (<http://support.automation.siemens.com/WW/view/en/1144348>), "Identification data" section.

¹ The function is only available if the used interface module supports the required system services.

Configuration

You can use either of the following to configure the 1SSI:

- STEP 7 V5.4 SP2 and later, or with the HSP (hardware support package, available online) STEP 7 V5.3 SP2 and later.
- A GSD file (<http://www.automation.siemens.com/csi/gsd>)

4.2 Isochronous Mode

Note

For basic information on isochronous mode, refer to the Isochronous mode (<http://support.automation.siemens.com/WW/view/en/15218045>) function manual.

Hardware Requirements

You will require the following for the 1SSI in isochronous mode:

- A CPU that supports isochronous mode
- PROFIBUS master or PROFINET controller that supports the constant bus cycle time
- An IM 151 that supports isochronous mode

Features

Depending on the system parameter assignment, the 1SSI works in either non-isochronous or isochronous mode.

In isochronous mode, the data communication between the master and 1SSI is isochronous to the bus cycle.

In isochronous mode, all bytes of the feedback interface are consistent.

If isochronous mode fails, the feedback interface is not updated. In the user program, this can be detected with the sign of life in the feedback interface.

4.3 Example: Starting 1SSI

Introduction

These instructions provide an example to guide you to a functioning application that will enable you to become familiar and check the basic hardware and software functions of the 1SSI. For this example, you will operate the 1SSI in standard mode, rather than isochronous mode.

Requirements

The following requirements must be satisfied:

- You must have put an ET 200S station on an S7 station with a DP master into operation.
- You must have the following:
 - A TM-E15S24-01 terminal module
 - An 1SSI
 - An SSI encoder and the necessary wiring material

Installation, Wiring and Fitting

1. Install and wire the TM-E15S24-01 terminal module (see Figure).
2. Plug the 1SSI into the terminal module. Detailed instructions are provided in the ET 200S Distributed I/O Device (<http://support.automation.siemens.com/WW/view/en/1144348>) operating instructions.

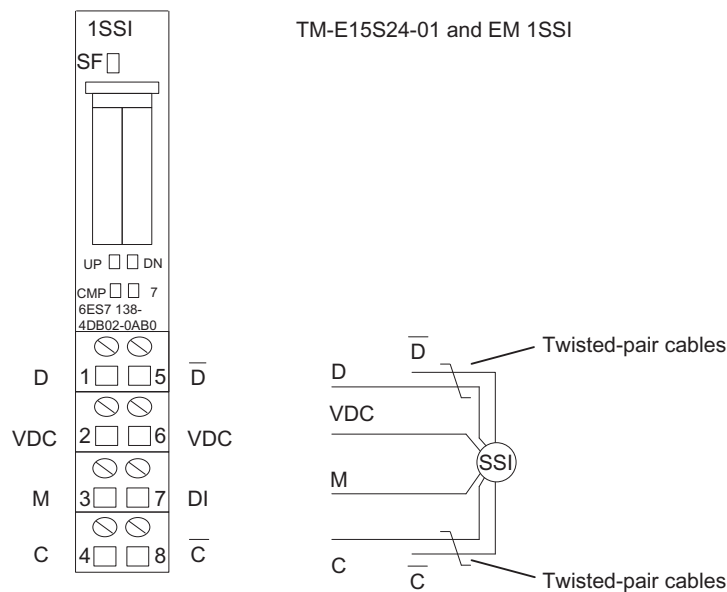

Figure 4-1 Terminal Assignment for the Example

Configuring with STEP 7 using HW Config

You must first adapt the hardware configuration of your existing ET 200S station.

1. Open the relevant project in SIMATIC Manager.
2. Open the HW Config configuration table in your project.
3. From the hardware catalog, select the 1SSI entry with the number 6ES7 138-4DB03-0AB0 in the infotext. Drag the entry to the slot at which you have installed your 1SSI.
4. Double-click this number to open the "Properties - DP Slave" dialog box.

On the "Addresses" tab, you will find the addresses of the slot to which you have dragged the 1SSI. Make a note of these addresses for subsequent programming.

On the "Parameters" tab, you will find the default settings for the 1SSI. Select the encoder type in accordance with the connected SSI encoder and enter all the required data. You will find the encoder data on the type label and in the technical specifications of the encoder.

5. Save and compile your configuration, and download the configuration in STOP mode of the CPU by choosing "PLC > Download to Module".

Creating a Block and Integrating It into the Controller Program

Create block FC 101 and integrate it in your control program (in OB 1, for example). This block requires the DB1 data block with a length of 16 bytes. The start address of the module in the following example is 256.

STL	Description
Block: FC101	
Network 1: Presettings	
L 0	//Delete control bits
T DB1.DB0	
T DB1.DB4	
Network 2: Write to the control interface	
L DB1.DB0	//Write 8 bytes to the 1SSI
T PAD 256	//Configured start address of the outputs
L DB1.DB4	
T PAD 260	
Network 3: Read from the feedback interface	
	//Read 8 bytes from the 1SSI
L PED 256	//Configured start address of the inputs
T DB1.DB8	
L PED 260	
T DB1.DB12	

Testing

Use Monitor/Modify Variables to monitor the encoder value and the direction indicator.

1. Select the "Block" folder in your project. Choose the "Insert > S7 Block > Variable Table" menu command to insert the VAT 1 variable table, and then confirm with OK.
2. Open the VAT 1 variable table, and enter the following variables in the "Address" column:
DB1.DBX8 (encoder value)
DB1.DBX12.0 (UP status)
DB1.DBX12.1 (DN status)
3. Choose "PLC > Connect To > Configured CPU" to switch to online.
4. Choose "Variable > Monitor" to switch to monitoring.
5. Switch the CPU to RUN mode.
6. Change the position of the SSI encoder.

Result

You can now see that:

- The UP LED or the DN LED on the 1SSI is on, depending on the direction in which you change the position of the SSI encoder.
- The encoder value in the block changes.

4.4 Terminal Assignment Diagram

Wiring Rules

The cables (terminals 1 and 5 and terminals 4 and 8) must be shielded, twisted-pair cables. The shield must be supported at both ends. To do this, use the shield contact (see the ET 200S Distributed I/O System (<http://support.automation.siemens.com/WW/view/en/1144348>) operating instructions).

4.4 Terminal Assignment Diagram

Terminal Assignment

You will find the terminal assignment for the 1SSI in the table below.

Table 4- 1 Terminal Assignment of the 1SSI

View	Terminal Assignment	Remarks
	<p>TM-E15S24-01 and EM 1SSI</p>	<p>Terminals 1 to 8: 1/5: Data from the SSI encoder ¹ 2/6: Power supply for absolute encoder and switch ² 3: Chassis ground 7: Digital input latch function 4/8: SSI clock (clock wire) ¹</p>
	<p>TM-E15S26-A1 and EM 1SSI</p>	
<p>¹ It is essential that you maintain the correct polarity when wiring the encoder. If you do not, an absolute encoder error is reported. Signals according to RS422</p> <p>² Short circuit-proof, maximum 0.5 A.</p>		

4.5 Configuring standard mode and fast mode

Introduction

In order to take full advantage of the functionality of the 1SSI for the application in question, choose between fast mode and standard mode, depending on your automation task.

Areas of Application	Mode
<ul style="list-style-type: none"> • Closed-loop control applications such as position controls with path position as actual value • Fast encoder value detection 	Fast
<ul style="list-style-type: none"> • Monitoring or detecting of position points • Length measurement, edge detection, synchronization with workpieces 	Standard

Configuring Standard Mode and Fast Mode

Standard Mode	Fast Mode
Parameters are assigned to the various modes. You will find the parameter lists in the descriptions of the modes.	
You can integrate the 1SSI in your project in two different ways. Decide whether you want to work with the GSD file or with STEP 7 using HW Config .	

Configuring 1SSI with STEP 7 using HW Config (in isochronous and non-isochronous mode)	
Select an entry from the hardware catalog that corresponds to the functionality you want.	
For standard mode, select the 1SSI entry with the number 6ES7 138-4DB03-0AB0 in the infotext.	For fast mode, select the 1SSI fast mode entry with the number 6ES7 138-4DB03-0AB0 Fast in the infotext.
Drag the entry to the slot at which you have installed your 1SSI.	
Select the parameters.	

Configuring 1SSI with the GSD file (only in non-isochronous mode)	
Select an entry in the GSD file that corresponds to the functionality you want.	
Select 6ES7 138-4DB03-0AB0 1SSI for standard mode.	Select 6ES7 138-4DB03-0AB0 1SSI Fast for fast mode.
Select the parameters.	

4.6 Functions of the 1SSI

4.6.1 Overview of 1SSI functions

Operating Principle

The 1SSI records the signals of the connected position encoder cyclically and forwards them, depending on the parameter assignment, to the feedback interface by means of the following functions:

- Encoder value detection
- Gray/binary converter
- Normalization
- Direction reversal
- Comparator (only in standard mode)
- Latch function (only in standard mode)
- Error detection
- Sign of life

The 1SSI uses the "ready for operation" feedback bit to indicate that the functions are executable and the displayed encoder value is valid.

4.6.2 Encoder Value Detection

Description

The absolute encoder transfers its encoder values in message frames to the 1SSI. The transmission of message frames is initiated by the 1SSI. The following alternatives are available for encoder value detection:

- Free-wheeling encoder value detection
- Synchronous encoder value detection
- Isochronous encoder value detection

You can set free-wheeling or synchronous encoder value detection in HW Config with the "Detection" parameter. This parameter only works in non-isochronous mode.

The detection of the encoder value will be isochronous when the 1SSI is in isochronous mode. In this case, the "Detection" parameter is not evaluated.

The following table shows these connections:

Table 4- 2 Encoder Value Detection

Mode	"Detection" Parameter	Encoder value detection
Non-isochronous mode	Free-wheeling	Free-wheeling encoder value detection
	Synchronous	Synchronous encoder value detection
Isochronous mode	- (irrelevant)	Isochronous encoder value detection

Free-Wheeling Encoder Value Detection

With free-wheeling encoder value detection, you obtain maximum accuracy with the latch function.

The 1SSI initiates the transmission of a message frame each time the assigned monoflop time elapses.

The 1SSI processes the detected encoder value asynchronously to these free-wheeling message frames in the cycle of the update rate.

This results in encoder values of various ages with the free-wheeling detection of encoder values. The difference between maximum and minimum age is the jitter.

Synchronous Encoder Value Detection

With synchronous encoder value detection, you obtain maximum accuracy with encoder value detection.

The 1SSI initiates the transmission of a message frame in the cycle of its update rate.

The 1SSI processes the transmitted encoder value synchronously to its update rate.

Isochronous Encoder Value Detection

Isochronous encoder value detection is carried out automatically when the equidistant bus cycle is activated in the DP master system and the DP slave is synchronized to the bus cycle.

The 1SSI initiates the transmission of a message frame in every bus cycle at time T_i , as long as the configured maximum encoder sampling rate does not result in a reduction.

The 1SSI processes the transmitted encoder value isochronously to the bus cycle.

4.6.3 Gray/Binary Converter

Description

When Gray is set, the encoder value supplied by the absolute encoder in gray code is converted to binary code. When Binary is set, the supplied encoder value is not converted.

NOTICE
If you selected the Gray setting, the 1SSI always converts the total encoder value (13 to 25 bits). Preceding special bits thus influence the encoder value and trailing bits can under some circumstances be corrupted.

4.6.4 Transmitted Encoder Value and Standardization

Description

The transmitted encoder value contains the encoder position of the absolute value encoder. Depending on the encoder that is used, other bits that are located before and after the encoder position are transmitted in addition to the encoder position.

So that the 1SSI can determine the encoder position, specify the following:

- Encoder type
- Number of trailing bits
- Total steps of the absolute encoder

With normalization, you specify the representation of the encoder value in the feedback interface.

- With "Normalization On", you specify that trailing, irrelevant bits in the encoder value are to be discounted (see the following example).
- With "Normalization Off", you specify that trailing bits are retained and are available for evaluation.

4.6.5 Detection of Direction and Reversal of the Direction of Rotation

Direction Detection

The 1SSI needs the following information to detect the direction of movement of the encoder correctly:

- Encoder type
- Total steps of the absolute encoder
- Number of trailing bits

The information is used as explained in the normalization example.

The direction of movement that is determined is displayed in the feedback interface and at the LEDs.

UP LED: encoder position change from lower to higher value

DN LED: encoder position change from higher to lower value

Direction Reversal

The direction reversal adjusts the direction of movement of the encoder to that of the axis.

Two settings are possible:

- **Off**

The direction of the transmitted encoder position is maintained.

- **On**

The direction of the transmitted encoder position is reversed. This means that although the encoder sends ascending values, descending values are displayed.

This reversal applies to the total steps of the absolute encoder, as indicated in the parameter assignment.

Example of Direction Reversal

Presettings:

You use a single-turn encoder with 2^{10} (corresponds to 10 bits) = 1024 steps/revolution (resolution/360°) with the following parameter assignment:

- Encoder type: SSI-13 bit
- Number of trailing bits: 3 places
- Direction reversal: On
- Total steps of the absolute encoder: 1024

Encoder value before direction reversal: cyclically recorded encoder position 1023

Encoder value after direction reversal: displayed encoder position 0

4.6.6 Comparator (Only in Standard Mode)

Description

The encoder position that is detected can be compared with up to two loadable values (without hysteresis). Both comparison results are stored in the feedback interface. The appropriate comparator becomes active only after the comparison value is loaded.

You set the two comparators in the Comparator 1 and Comparator 2 parameters:

Setting	Effect on the Result of Comparison (CMPx)
Not active	The encoder value is not compared. The feedback bit CMPx = 0.
In the up direction	The encoder value is compared in the up direction (UP). <ul style="list-style-type: none"> • If the encoder value \geq the comparison value, the feedback bit CMPx = 1. • If the encoder value $<$ the comparison value, the feedback bit CMPx = 0. • If the direction is down, the feedback bit CMPx remains unchanged. • If no change is detected in the encoder value, the feedback bit CMPx remains unchanged.
In the down direction	The encoder value is compared in the down direction (DN). <ul style="list-style-type: none"> • If the encoder value \leq the comparison value, the feedback bit CMPx = 1. • If the encoder value $>$ the comparison value, the feedback bit CMPx = 0. • If the direction is up, the feedback bit CMPx remains unchanged. • If no change is detected in the encoder value, the feedback bit CMPx remains unchanged.
In both directions	The encoder value is compared in both directions. If the direction is up, the following conditions apply: <ul style="list-style-type: none"> • If the encoder value \geq the comparison value, the feedback bit CMPx = 1. • If the encoder value $<$ the comparison value, the feedback bit CMPx = 0. If the direction is down, the following conditions apply: <ul style="list-style-type: none"> • If the encoder value \leq the comparison value, the feedback bit CMPx = 1. • If the encoder value $>$ the comparison value, the feedback bit CMPx = 0. • If no change is detected in the encoder value, the feedback bit CMPx remains unchanged.

As soon as you load a comparison value, the comparison result is deleted and is then entered in accordance with the directional setting.

Note

Only one control bit can be set at a particular time:

CMP_VAL1 or CMP_VAL2.

Otherwise, the ERR_LOAD error is reported until both control bits are deleted.

Loading the Comparison Value

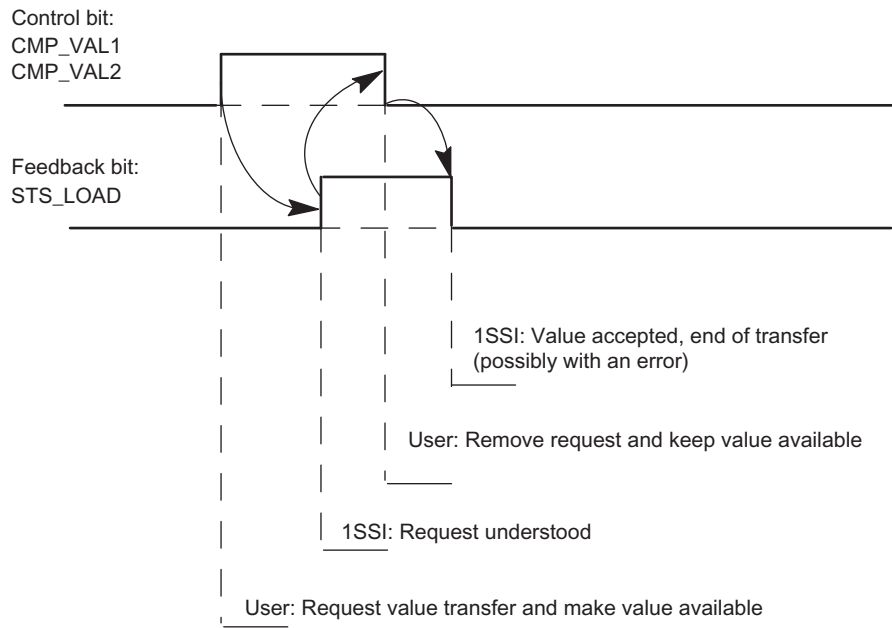

Figure 4-2 Value Transfer

Comparator in Isochronous Mode

In isochronous mode, the comparison values are loaded at time T_o and are effective as of time T_i in the same bus cycle.

4.6.7 Latch Function (Only in Standard Mode)

Description

You use the latch function to freeze the current encoder value of the 1SSI at an edge at the digital input (DI).

The encoder value can thus be evaluated on an event-dependent basis.

A frozen encoder value is identified by the set bit 31 and is preserved until the termination of the latch function.

The frozen encoder value is entered at the feedback interface at the position of the cyclically recorded value and assigned the identifier "Bit 31 set."

Note

Direction determination, comparison, and error monitoring also take place when the encoder value is frozen.

Prerequisites for Using the Latch Function

- You must have specified which edge (rising and/or falling) at the digital input freezes the encoder value.
- You specify that the latch function that is coupled to the digital input is switched on.

Terminating the Latch Function

The latch function must be acknowledged. When the controller program acknowledges the acceptance of the encoder value, bit 31 is deleted and the encoder value is updated again. Freezing is then possible again.

1SSI: latch function is active, encoder value is frozen (bit 31 = 1), wait for LATCH_ACK

User: LATCH must be acknowledged with LATCH_ACK = 1

1SSI: Latch function is terminated; encoder value is current

User: LATCH_ACK must be cleared; freezing is possible again as soon as 1SSI detects LATCH_ACK = 0

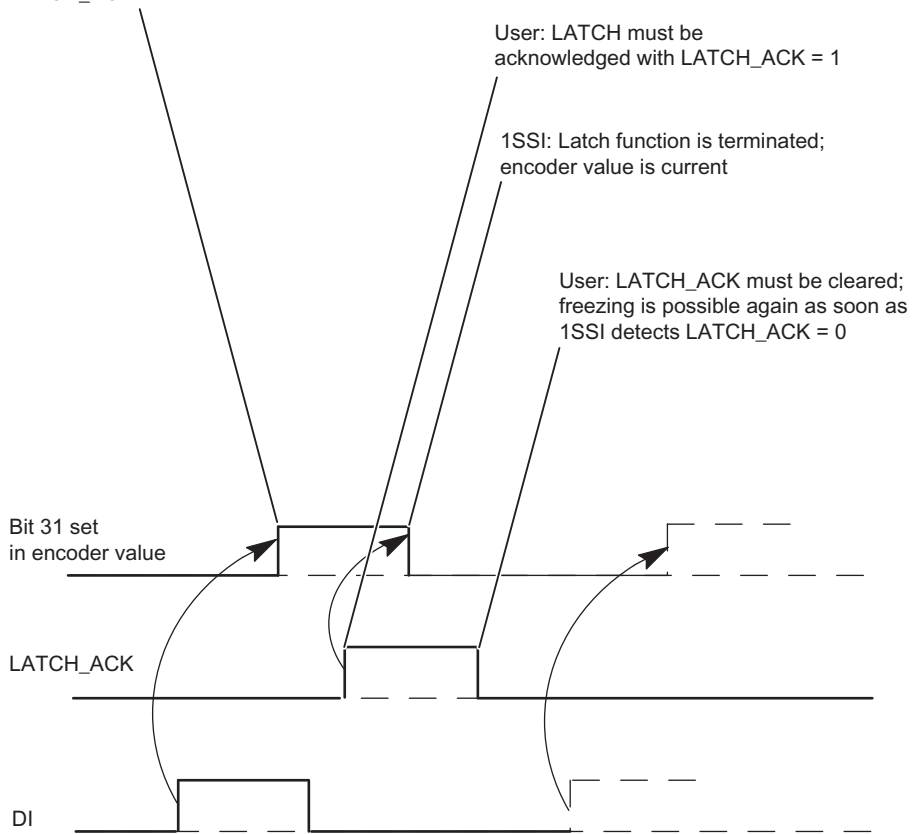

Figure 4-3 Latch Function

4.6.8 Error Detection in Standard Mode

Description

The absolute value encoder and sensor supply short circuit errors must be acknowledged. They have been detected by the 1SSI and are indicated at the feedback interface. Channel-specific diagnostics are performed if you have enabled group diagnostics in your configuration (see device manual of the interface module used).

The parameter assignment error bit is acknowledged by means of correct parameter assignment.

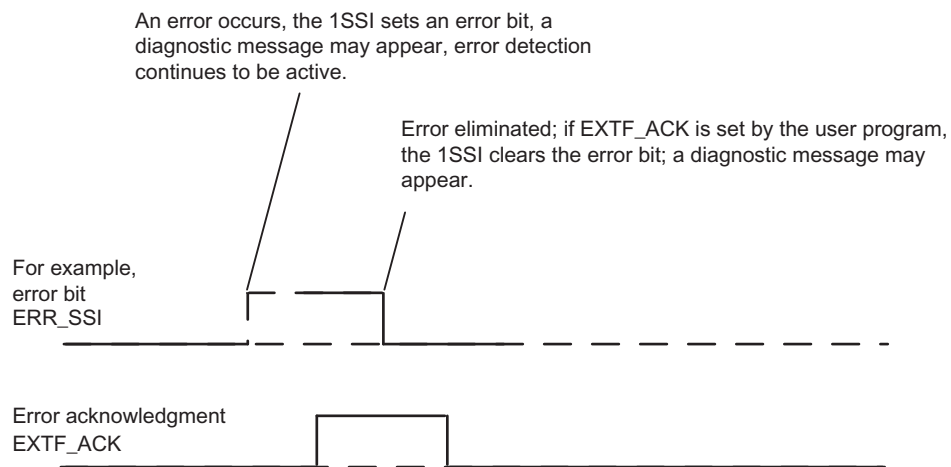

Figure 4-4 Error Acknowledgment

In the case of constant error acknowledgement ($EXTF_ACK = 1$) or in CPU/master STOP mode, the 1SSI reports the errors as soon as they are detected and clears the errors as soon as they are eliminated.

4.6.9 Error Detection in Fast Mode

Description

The absolute value encoder and sensor supply short circuit errors have been detected by the 1SSI and are indicated at the feedback interface. Channel-specific diagnostics are performed if you have enabled group diagnostics in your configuration (see device manual of the interface module used).

The parameter assignment error bit is acknowledged by means of correct parameter assignment.

As soon as the absolute value encoder and sensor supply short circuit errors are no longer detected by the 1SSI, the error display at the feedback interface is cleared, and in certain cases the channel-specific diagnosis reports an error-free condition.

4.7 Behavior at CPU/master STOP

Description

The 1SSI detects the CPU/master STOP. The reaction to this is to stop the active operation.

Exiting the CPU/master STOP status

Without reassigning the parameters of the ET 200 station	<ul style="list-style-type: none"> The feedback interface of the 1SSI remains current.
With reassignment of the parameters of the ET 200 station	<ul style="list-style-type: none"> You must reload the comparison values. The latch function has to be triggered with a new edge on the digital input DI.

Reassigning Parameters of the ET 200S Station

Reconfiguration of the ET 200S station is carried out by your CPU/master at:

- POWER ON of the CPU/master
- Upon power on of the IM 151
- After failure of the bus transmission
- Upon loading changed parameters or configuration of the ET 200S station to the CPU/master

4.8 Setting parameters for the 1SSI

Overview

You set the parameters for the 1SSI by means of the GSD file for the ET 200S or using the STEP 7 parameter assignment software. It is not possible to reassign the parameters by means of the user program.

Depending on the mode that you selected, either of the following parameter sets from your parameter assignment software appear in the parameter assignment software:

- All parameters (standard mode), or
- A portion of the parameters (fast mode)

You can enter the following parameters (the default appears in bold):

Parameters	Value Range	Note
Group diagnostics	Disable /enable	Enabling parameter
Detection	Free-wheeling /synchronous	This parameter is irrelevant in isochronous mode and is not evaluated.
Encoder type ¹	No encoder/ SSI 13-bit / ... / SSI 25-bit	No encoder: The encoder input is switched off.
Gray/binary converter ¹	Gray /binary	Code supplied by the encoder
Transmission rate ^{1 3}	125 kHz / 250 kHz / 500 kHz / 1 MHz / 1.5 MHz / 2 MHz	Note that the transmission rate affects the accuracy and up-to-dateness of the encoder values.
Monoflop time ^{1 2 3}	16 µs / 32 µs / 48 µs / 64 µs	The specification of the monoflop time is relevant for free-wheeling encoder value detection. See the vendor's technical specifications.
Parity	None , odd, even	An assigned parity bit is included in the "Encoder Type" parameter. If a 25-bit encoder is assigned parity, then 26 bits are read from the encoder. The bit following the LSB (least significant bit) is evaluated as a parity bit. A parity error is reported by means of the following feedback interfaces: <ul style="list-style-type: none"> • EXTf in fast mode • ERR_SSI in standard mode
Normalization	Off /on	–
Number of trailing bits ¹	0 to 15	The number of trailing bits must be specified.
Direction reversal	Off /on	–

4.8 Setting parameters for the 1SSI

Parameters	Value Range	Note
Total steps of the absolute encoder ¹	<ul style="list-style-type: none"> • Encoder type 13 bits: 16 to 8192 • Encoder type 14 bits: 16 to 16384 • Encoder type 15 bits: 16 to 32768 • Encoder type 16 bits: 16 to 65536 • Encoder type 17 bits: 16 to 131072 • Encoder type 18 bits: 16 to 262144 • Encoder type 19 bits: 16 to 524288 • Encoder type 20 bits: 16 to 1048576 • Encoder type 21 bits: 16 to 2097152 • Encoder type 22 bits: 16 to 4194304 • Encoder type 23 bits: 16 to 8388608 • Encoder type 24 bits: 16 to 16777216 • Encoder type 25 bits: 16 to 33554432 	If you find "Total steps - highword" and "Total steps - lowword" in your parameter assignment software instead of "Total steps", the following definition applies: <i>Total steps = total steps lowword + total steps highword x 2¹⁶</i>
Latch: Encoder value	Not active / With rising edge DI / With falling edge DI / With both edges DI	This parameter is available in the parameter assignment software in standard mode only. Not active: The encoder value cannot be frozen.
Comparator 1	Not active / In the up direction / In the down direction / In both directions	This parameter is available in the parameter assignment software in standard mode only. Not active: The comparator is switched off.
Comparator 2	Not active / In the up direction / In the down direction / In both directions	This parameter is available in the parameter assignment software in standard mode only. Not active: The comparator is switched off.
Sign of life	Off, On	This parameter is only active in isochronous mode. When sign of life is on, the sign-of-life bit is toggled, i.e., the last sent value is inverted, each time an encoder value is read in in isochronous mode. If a reduction is assigned in the "Encoder Sampling Rate" parameter, the value is toggled only if an encoder value was actually read in. You can find the sign-of-life bit in the feedback interface in: <ul style="list-style-type: none"> • Byte 4/bit 7 (standard mode) • Byte 0/bit 7 (fast mode)

Parameters	Value Range	Note
Encoder sampling rate	No limitation , 0.1 kHz to 6.3 kHz (in 0.1-kHz steps)	Any encoder sampling rate to be taken into account is set here. This parameter is only active in isochronous mode. It enables the use of slower encoders (such as ultrasound encoders) even in a fast processing cycle. An integer reduction n is calculated using the set frequency. In this case, the encoder is read in again only every nth clock cycle. Example: Processing cycle 500 µs Encoder sampling rate: 1.2 kHz (approximately every 833 µs) --> reduction n = 2, i.e., the encoder is read in again only every 2nd processing cycle, i.e., every ms.
<p>¹ See the technical specifications of the absolute encoder.</p> <p>² The monoflop time is the time between 2 SSI frames. The assigned monoflop time must be greater than the monoflop time of the absolute encoder (refer to the technical specifications of the manufacturer).</p> <p>³ The following limitation applies to the monoflop time of the absolute encoder: (1/transmission rate) < monoflop time of absolute encoder < 64 µs</p>		

4.9 Diagnostics

4.9.1 Diagnostics using the LED display

LED display on the 1SSI

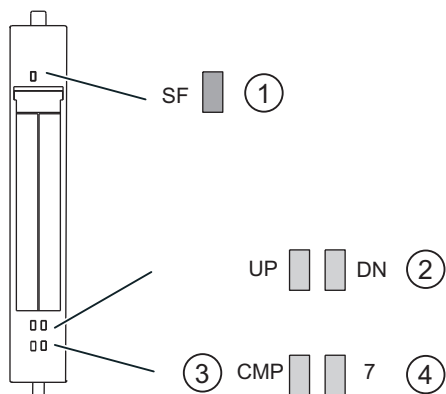

- ① Group error (red)
- ② Status display for change in sensor value (green)
- ③ Status display for result of comparison
- ④ Status display for digital input (green)

Status and error displays by means of LEDs on the 1SSI

The table below shows the status and error displays on the 1SSI.

Event (LEDs)					Cause	Remedy
SF	UP	DN	CMP	7		
On					No parameter assignment. There is a diagnostic message.	Check the parameter assignment. Evaluate the diagnostics data.
	On				At value change from smaller to larger sensor values (including zero-crossing)	
		On			At value change from larger to smaller sensor values (including zero-crossing)	
			On		Set for comparison result CMP 1	
				On	DI (latch) is activated.	

4.9.2 Error types

For information on the structure of the channel-related diagnostics, refer to the manual on the interface module used in your ET 200S station.

1SSI error types

The following table shows the error types on the 1SSI.

Error class		Meaning	Remedy
1 _D	00001: Short circuit	Short circuit of the supply to the absolute encoder.	Correct the process wiring.
9 _D	01001: Error	Internal module error occurred. Load voltage from the power module is too low.	Replace the module. Correct the process wiring. Check the load voltage.
16 _D	10000: Parameter assignment error	Parameters have not been assigned to the module.	Correct the parameter assignment.
26 _D	11010: External error	Start/Stop bit error (error absolute encoder): Wire break in the sensor cable, or sensor cable is not connected. Sensor type, transmission rate, and monoflop time do not correspond to the sensor connected; programmable sensors do not correspond to the settings on the 1SSI electronic module. Sensor is defective or there are faults.	Replace the sensor; correct the process wiring. Correct the parameter assignment.

4.10 Control and Feedback Interfaces in Standard Mode

Note

For the 1SSI, the following data of the control and feedback interface are consistent:

Byte 0 to 3

Byte 4 to 7

Use the access or addressing mode for data consistency over the entire control and feedback interface on your master (only for configuration using the GSD file).

Description

The two tables show the assignment of the control interface (outputs) and the feedback interface (inputs):

Table 4- 3 Assignment of the Feedback Interface (Inputs)

Address	Assignment
Bytes 0 to 3	Encoder value double word (bit 31 set, encoder value frozen)
Byte 4	Bit 7: Reserved = 0 or sign of life LZ Bit 6: Ready for operation RDY Bit 5: Parameter assignment error ERR_PARA Bit 4: Absolute encoder error ERR_SSI Bit 3: Encoder supply short circuit ERR_24V Bit 2: Status DI STS_DI Bit 1: Status DN STS_DN Bit 0: Status UP STS_UP
Byte 5	Bit 7: Reserved = 0 Bit 6: Reserved = 0 Bit 5: Reserved = 0 Bit 4: Reserved = 0 Bit 3: Comparison value 2 reached, CMP2 Bit 2: Comparison value 1 reached, CMP Bit 1: Load function error, ERR_LOAD Bit 0: Load function running, STS_LOAD
Bytes 6 to 7	Reserved = 0

Table 4-4 Assignment of the Control Interface (Outputs)

Address	Assignment
Bytes 0 to 3	Comparison value 1 or 2 (double word)
Byte 4	Bit 7: Error acknowledgment EXTF_ACK Bit 6: Acknowledgment of latch function LATCH_ACK Bit 5: Reserved = 0 Bit 4: Reserved = 0 Bit 3: Reserved = 0 Bit 2: Reserved = 0 Bit 1: Load comparison value 2, CMP_VAL2 Bit 0: Load comparison value 1, CMP_VAL1
Byte 5	Reserved = 0
Bytes 6 to 7	Reserved = 0

Notes on the Control and Feedback Bits

Bits	Notes
CMP	Comparison result of comparator 1
CMP2	Comparison result of comparator 2
CMP_VAL1	Load comparison value 1
CMP_VAL2	Load comparison value 2
ERR_24V	The encoder supply is short circuited. ERR_24V is reset when the short circuit is eliminated and acknowledged with the EXTF_ACK control bit.
ERR_LOAD	Error while loading the comparison values because both control bits CMP_VAL1 and CMP_VAL2 are set.
ERR_PARA	Incorrect parameter assignment for the ET 200S station. Cause: Total steps of the absolute encoder are not in the range of values for the type of encoder. The parameter bit is cleared when a correct parameter assignment is transmitted.
ERR_SSI	The 1SSI detects an absolute encoder error if the message frames at the SSI interface are faulty. Causes: No encoder connected; wire break in the encoder cable; over voltage of encoder supply; type of encoder, transmission rate, parity error, monoflop time do not correspond to the connected encoder; programmable encoders do not correspond to the settings on the 1SSI; encoder is defective or faults exist. ERR_SSI is reset when the cause of the error is eliminated and acknowledged with the EXTF_ACK control bit.
EXTF_ACK	Error acknowledgement for the absolute encoder ERR_SSI and encoder supply short circuit ERR_24V errors
LATCH_ACK	Acknowledgement for latch function
LZ	This parameter is only active in isochronous mode. When sign of life is on, the sign-of-life bit is toggled, i.e., the last sent value is inverted, each time an encoder value is read in in isochronous mode. If a reduction is assigned in the "Encoder Sampling Rate" parameter, the value is toggled only if an encoder value was actually read in.
STS_DI	The bit displays the status of the digital input DI.
STS_DN	Status direction down; for encoder value change from larger to smaller encoder positions (including zero crossover)
STS_LOAD	Feedback bit for CMP_VAL1 and CMP_VAL2. The 1SSI uses this bit to indicate that a comparison value is loaded.

Bits	Notes
STS_UP	Status direction down; for encoder value change from larger to smaller encoder positions (including zero crossover)
RDY	The parameter assignment of the 1SSI is correct, and the module is executing its functions. The displayed feedback is valid. For the absolute value encoder error, ERR_SSI is also set.

Access to the Control and Feedback Interface in STEP 7 Programming

	Configuring with STEP 7 using the GSD file ¹⁾ (Hardware catalog\PROFIBUS-DP\ Additional FIELD DEVICES\ET 200S)	Configuring with STEP 7 using HW Config (Hardware catalog\PROFIBUS-DP\ ET 200S)
Feedback interface	Read with SFC 14 "DPRD_DAT"	Load command, e.g. L PID
Control interface	Write with SFC 15 "DPWR_DAT"	Transfer command, e.g. T PQD
¹ Load and transfer commands are also possible with CPU 3xxC, CPU 318-2 (as of V3.0), CPU 4xx (as of V3.0) and WinLC RTX (PC CPU).		

4.11 Feedback Interface in Fast Mode

Description

Refer to the table below for the assignment of the feedback interface (inputs):

Table 4- 5 Assignment of the Feedback Interface (Inputs)

Address	Assignment
Bytes 0 to 3	Bit 31: Reserved = 0 or sign of life LZ Bit 30: Ready for operation (feedback is valid) RDY Bit 29: Parameter assignment error ERR_PARA; Bit 28: Group error absolute encoder or encoder supply short circuit EXTf Bit 27: Status DI STS_DI Bit 26: Status DN STS_DN Bit 25: Status UP STS_UP Bytes 0 to 24: Encoder value

Notes on the Feedback Bits

Bits	Notes
ERR_PARA	Incorrect parameter assignment for the ET 200S station. Cause: Total steps of the absolute encoder are not in the range of values for the type of encoder. The parameter bit is cleared when a correct parameter assignment is transmitted.
EXTf	Group error absolute encoder or encoder supply short circuit Causes: The encoder supply is short circuited or No encoder connected; wire break in the encoder cable; type of encoder, transmission rate, monoflop time do not correspond to the connected encoder; programmable encoders do not correspond to the settings on the 1SSI; encoder is defective or faults or parity errors exist. EXTf is reset when the causes of the errors are eliminated.
LZ	This parameter is only active in isochronous mode. When sign of life is on, the sign-of-life bit is toggled, i.e., the last sent value is inverted, each time an encoder value is read in in isochronous mode. If a reduction is assigned in the "Encoder Sampling Rate" parameter, the value is toggled only if an encoder value was actually read in.
STS_DI	The bit displays the status of the digital input DI.
STS_DN	Status direction down; for encoder value change from larger to smaller encoder positions (including zero crossover)
STS_UP	Status direction down; for encoder value change from larger to smaller encoder positions (including zero crossover)
RDY	The parameter assignment of the 1SSI is correct, and the module is executing its functions. The displayed feedback is valid. For the absolute value encoder error, ERR_SSI is also set.

Access to the Feedback Interface in STEP 7 Programming

	Configuring with STEP 7 using the GSD File	Configuring with STEP 7 using HW Config
Feedback interface	Read with SFC 14 "DPRD_DAT"	Load command (e.g. L PID)

4.12 Technical Specifications

Overview

General technical specifications	
Dimensions and Weight	
Dimensions W x H x D (mm)	15 x 81 x 52
Weight	Approx. 40 g
Voltages, Currents, Potentials	
Rated load voltage L+ • Reverse polarity protection	24 VDC Yes
Galvanic isolation • Between backplane bus and SSI function • Between SSI function and load voltage L+	Yes No
Encoder supply • Output voltage • Output current	L+ (-0.8 V) Max. 500 mA (Total current at terminals 2 and 6), short-circuit proof
Current consumption • From the backplane bus • From load voltage L+ (no load)	max. 10 mA max. 40 mA
Power dissipation of the module	1.0 W
SSI Module Encoder Input	
Position feedback	Absolute
Differential signals for SSI data and SSI clock	According to RS422
Data transmission rate and wire length with absolute encoders (twisted pair and shielded) *)	<ul style="list-style-type: none"> • 125 kHz max. 320 m • 250 kHz max. 160 m • 500 kHz max. 60 m • 1 MHz max. 20 m • 1.5 MHz max. 10 m • 2 MHz max. 8 m
Digital Input	
Input voltage	0 signal: -30 ... 5 V 1 signal: 11 ... 30 V
Input current	0 signal: ≤2 mA (quiescent current) 1 signal: 9 mA (typically)
Input delay	0 > 1: max. 300 μs 1 > 0: max. 300 μs
Connection of a two-wire BERO type 2	Possible
Shielded cable length	50 m
Status, Interrupts, Diagnostics	

General technical specifications						
Interrupts						
Status display for digital input DI	LED 7 (green)					
Status display of first comparator CMP	CMP LED (green)					
Encoder value change Up	UP LED (green)					
Encoder value change Down	DN LED (green)					
Group error	SF LED (red)					
Encoder Value Inaccuracy in Non-Isochronous Mode						
Free-wheeling encoder value detection						
<ul style="list-style-type: none"> • Maximum age <ul style="list-style-type: none"> – Standard mode – Fast mode 	<ul style="list-style-type: none"> (2 × frame transfer rate) + monoflop time + 1 μs (2 × frame transfer rate) + monoflop time + 700 μs 					
<ul style="list-style-type: none"> • Jitter <ul style="list-style-type: none"> – Standard mode – Fast mode 	<ul style="list-style-type: none"> Frame runtime + Monoflop time Frame runtime + Monoflop time 					
Synchronous encoder value detection						
<ul style="list-style-type: none"> • Age <ul style="list-style-type: none"> – Standard mode – Fast mode 	<ul style="list-style-type: none"> Frame runtime + 1 ms Frame transfer rate + 700 μs 					
Isochronous encoder value detection						
<ul style="list-style-type: none"> • Age in standard mode and fast mode 	Encoder value at time T_i of the current bus cycle					
Latch Value Inaccuracy in Non-Isochronous Mode						
Free-wheeling encoder value detection						
<ul style="list-style-type: none"> • Jitter in standard mode and fast mode 	Frame runtime + Monoflop time					
Synchronous encoder value detection						
<ul style="list-style-type: none"> • Jitter <ul style="list-style-type: none"> – Standard mode – Fast mode 	<ul style="list-style-type: none"> 1 ms 700 μs 					
Isochronous encoder value detection						
<ul style="list-style-type: none"> • Jitter in standard mode and fast mode 	Frame runtime + Monoflop time					
Frame runtime of the encoders (for selected encoder widths without parity bit)						
	13 bits	14 bits	16 bits	21 bits	24 bits	25 bits
• 125 kHz	112 μs	120 μs	136 μs	176 μs	200 μs	208 μs
• 250 kHz	56 μs	60 μs	68 μs	88 μs	100 μs	104 μs
• 500 kHz	28 μs	30 μs	34 μs	44 μs	50 μs	52 μs
• 1 MHz	14 μs	15 μs	17 μs	22 μs	25 μs	26 μs
• 1.5 MHz	9 μs	10 μs	11 μs	15 μs	17 μs	17 μs
• 2 MHz	7 μs	8 μs	9 μs	11 μs	13 μs	13 μs
Monoflop time ¹	16 μs / 32 μs / 48 μs / 64 μs					

General technical specifications		
Response Times in Non-Isochronous Mode		
Update rate of the 1SSI		
<ul style="list-style-type: none"> In standard mode In fast mode 	1 ms	700 μ s
Isochronous Times for the Module		
<ul style="list-style-type: none"> In standard mode 	TCI	125 μ s + Frame runtime (in μ s)
	TCO	125 μ s
	T _{oi} Min	0 μ s
	T _{DP} Min	400 μ s + Frame runtime if frame runtime > 100 μ s 500 μ s if frame runtime \leq 100 μ s
<ul style="list-style-type: none"> In fast mode 	TCI	70 μ s + Frame runtime (in μ s)
	TCO	0 μ s
	T _{oi} Min	0 μ s
	T _{DP} Min	210 μ s + Frame runtime if frame runtime > 40 μ s 250 μ s if frame runtime \leq 40 μ s

¹ The following restriction applies to the monoflop time of the absolute encoder:
 $(1/\text{transmission rate}) < \text{monoflop time of the absolute encoder} < 64 \mu\text{s}$

²) As long as the encoder in use does not require a shorter line length.

2PULSE

5.1 Product Overview

Order number

6ES7 138-4DD01-0AB0

Compatibility

The 2PULSE with the order number 6ES7 138-4DD01-0AB0 replaces the 2PULSE with the order number 6ES7 138-4DD00-0AB0 compatibly. In STEP 7 as of Version V5.4 SP4 + HSP 2072, you can use it in non-isochronous and isochronous modes.

Features

- 2-channel
 - The two channels of the 2PULSE can be used independently of one another; they permit pulse output in 5 different modes.
 - Minimum pulse duration: 100 μ s,
 - Accuracy: \pm (period duration x 100 ppm) \pm 100 μ s
- Digital output DO 0 for channel 0 and digital output DO 1 for channel 1 to output the pulses.
 - Integrated freewheeling diodes in the digital outputs. No external freewheeling diode required at inductive loads
- Digital input DI 0 for Channel 0 and digital input DI 1 for Channel 1 for enabling (starting of output).
- Can be used with short and long control interface
 - Short control interface: 8 bytes – compatible to predecessor module
 - Long control interface: 12 bytes – improved controlling options

Operating Modes

- "Pulse output" operating mode
A pulse with variable pulse duration is output at the digital output of the 2PULSE.
- "Pulse width modulation" operating mode
A pulse sequence (square wave signal) with defined time period and variable pulse/pause ratio is output at the digital output of the 2PULSE.
- "Pulse train" operating mode
A variable number of pulses with defined time period and pulse duration is output at the digital output of the 2PULSE.
- "On/Off-delay" operating mode
The signal pending at the digital input DI is output with an on/off-delay at the digital output DO by the 2PULSE.
- "Frequency output" operating mode
A square wave signal with variable frequency is output at the digital output of the 2PULSE.

Functions

- Measurement of current in the "Pulse width modulation" and "Pulse train" operating modes
- Direct control of the digital output by means of the control program
- Error detection/diagnostics (short circuit of the digital output and encoder supply)
- Parallel connection of both channels of the 2PULSE to achieve a higher output current
- Programmable response to CPU/master STOP

Configuration

In order to configure the 2PULSE use one of the following options

- STEP 7 as of Version V5.4 SP4 with the HSP 2072 (Hardware Support Package from the Internet)
- A GSD file (<http://www.automation.siemens.com/csi/gsd>)

Firmware update

In order to extend the functionality and eliminate errors, firmware updates can be downloaded to the operating system memory of the 2PULSE by means of the STEP 7 HW Config software.

Note

When you launch the firmware update, the old firmware is deleted. If the firmware update is interrupted or canceled for any reason, the 2PULSE will no longer function correctly as a result. Restart the firmware update and wait until it has completed successfully.

5.2 Isochronous mode

Note

For basic information on isochronous mode, refer to the Isochronous mode (<http://support.automation.siemens.com/WW/view/en/15218045>) function manual.

Hardware requirements

You will require the following for the 2PULSE in isochronous mode:

- A CPU that supports isochronous mode
- PROFIBUS master or PROFINET controller that supports the constant bus cycle time
- IM 151 that supports isochronous mode

Response of the 2PULSE

Depending on the system parameter assignment, the 2PULSE works in either non-isochronous or isochronous mode.

In isochronous mode

- The output sequences are started at the moment T_0 when the software is enabled.
- Data communication between the bus master and 2PULSE is isochronous to the cycle.
- All 8 bytes of the feedback interface are consistent.

In case of a parameter assignment error, the 2PULSE does not go into isochronous mode.

If isochronous mode fails due to faults or failure/delay of global control (GC), the 2PULSE returns to isochronous mode during the next cycle without an error response.

If isochronous mode fails, the feedback interface is not updated.

5.3 Example: Starting 2PULSE

Task

These brief instructions guide you to a functioning application that will enable you to become familiar and check the basic hardware and software functions of your 2PULSE. The "Pulse output" mode is used as an example here. Channel 0 of the 2PULSE is used in the example.

Requirements

The following requirements must be satisfied:

- You must have put an ET 200S station on an S7 station with a DP master into operation.
- You must have the following:
 - An interface module IM151-1 (as of order number 6ES7 151-1AA04-0AB0) or IM151-1 HIGH FEATURE (as of order number 6ES7 151-1BA02-0AB0) or IM151-8 PN/DP CPU (as of order number 6ES7 151-8AB00-0AB0) or IM151-7 CPU (as of order number 6ES7 151-7AA20-0AB0)
 - A terminal module TM-E15S24-01 or TM-E15x26-A1 (order number 6ES7 193-4CBx0-0AA0 or 6ES7 193-4CAx0-0AA0)
 - A "2 PULSE" (order number 6ES7 138-4DD01-0AB0).

Installation and Fitting

1. Install the TM-E15S24-01 terminal module (see the figure below).
2. Plug the 2PULSE into the terminal module. Detailed instructions are provided in the ET 200S Distributed I/O Device (<http://support.automation.siemens.com/WW/view/en/1144348>) operating instructions. It is not necessary to wire the 2PULSE for this example.

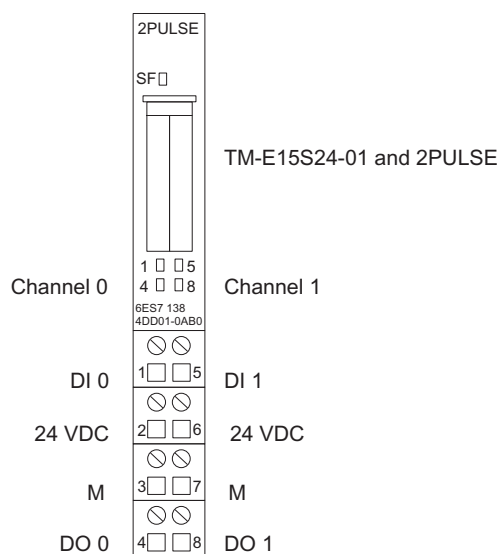

Figure 5-1 Terminal assignment of the 2PULSE for the example

Configuring with STEP 7 using HW Config

You must first adapt the hardware configuration of your existing ET 200S station.

1. Open the relevant project in SIMATIC Manager.
2. Open the HW Config configuration table in your project.
3. Select "2 PULSE" with the number 6ES7 138-4DD01-0AB0 in the hardware catalog. Drag the entry to the slot at which you have mounted your 2PULSE.

Note

Do not use the entry "2 PULSE ext. control interface", otherwise the example program below will not function.

4. Double-click this slot to open the "Properties - 2PULSE" dialog box.
On the "Addresses" tab, you will find the addresses of the slot to which you have dragged the 2PULSE. Make a note of these addresses for subsequent programming.
On the "Parameters" tab, you will find the default settings for the 2PULSE. Set the operating mode to "Pulse output". Leave the other default settings unchanged.
5. Save and compile your configuration, and download the configuration in STOP mode of the CPU by choosing "PLC > Download to Module".

Integration into the Control Program

Create block FC 101 and integrate it in your control program (in OB 1, for example). This block works in this example with the MB10, MB20 and M30.0 memory bits.

In block FC 101, the start address of the inputs and outputs of the 2PULSE is 256. If necessary, take the address from the hardware configuration.

This block sets a pulse duration of 500 ms and starts pulse output as soon as you have issued the enable using your control program (SW_ENABLE = 1).

STL	Description
Block: FC101	
L	PEB256 //Read feedback messages from Channel 0 of the 2PULSE
T	MB20
L	5000 //Write pulse duration of 500 ms to Channel 0 of the 2PULSE
T	PAW256
L	0 //Create control signal SW_ENABLE
T	MB10
U	M30.0 //Query start of pulse output
=	M10.0 //Set SW_ENABLE = 1
L	MB10
T	PAB258 //Write control signals to Channel 0 of the 2PULSE

Testing

Start a pulse output with SW_ENABLE = 1 and monitor the STS_ENABLE and STS_DO feedback bits using "Monitor/Modify Variables".

1. Select the "Block" folder in your project. Choose the "Insert > S7 Block > Variable Table" menu command to insert the VAT 1 variable table, and then confirm with OK.
2. Open the VAT 1 variable table, and enter the following variables in the "Address" column:
 M20.0 (STS_ENABLE)
 M20.1 (STS_DO)
 M30.0 (SW_ENABLE)
3. Choose "PLC > Connect To > Configured CPU" to switch to online.
4. Choose "Variable > Monitor" to switch to monitoring.
5. Switch the CPU to RUN mode.

Result

The following table shows you which activity triggers which result.

Activity	Result
When you switch the CPU to RUN, the following results are obtained:	<ul style="list-style-type: none"> • All the LEDs are turned off • STS_ENABLE = 0 • STS_DO = 0
Start the pulse output by setting memory bit 30.0 (Variable → Modify →) Directly after the start... After the 500 ms pulse duration has expired	<ul style="list-style-type: none"> • STS_ENABLE = 1 • STS_DO = 1 • LED 4 for DO 0 lights up • STS_ENABLE = 0 • STS_DO = 0 • LED 4 for DO 0 is turned off

To start further pulse output, you must delete SW_ENABLE (memory bit M30.0 = 0) and reset it (memory bit M30.0 = 1).

You can change the pulse duration in the control program.

5.4 Modes and Functions

5.4.1 Overview

Principle

The 2PULSE has two channels. You can select a separate mode for each channel. Configuration of the operating mode is carried out using HW Config. The mode that has been assigned parameters can then no longer be changed with your control program.

You can select from 5 different modes for each channel:

- Pulse output
- Pulse-width modulation
- Pulse train
- On/Off-delay
- Frequency output

In addition to the set mode, the 2PULSE also has the following functions:

- Measurement of current in the "Pulse width modulation" and "Pulse train" operating modes
- Direct control of the DO digital output by means of your control program; controllable separately for each channel.
- Error detection/diagnostics; the 2PULSE recognizes the errors for each channel separately.

- Parallel connection of both channels to achieve a higher output current.
- Response to CPU/master STOP; the 2PULSE recognizes the CPU/master STOP for both channels and responds in accordance with your parameter assignment.

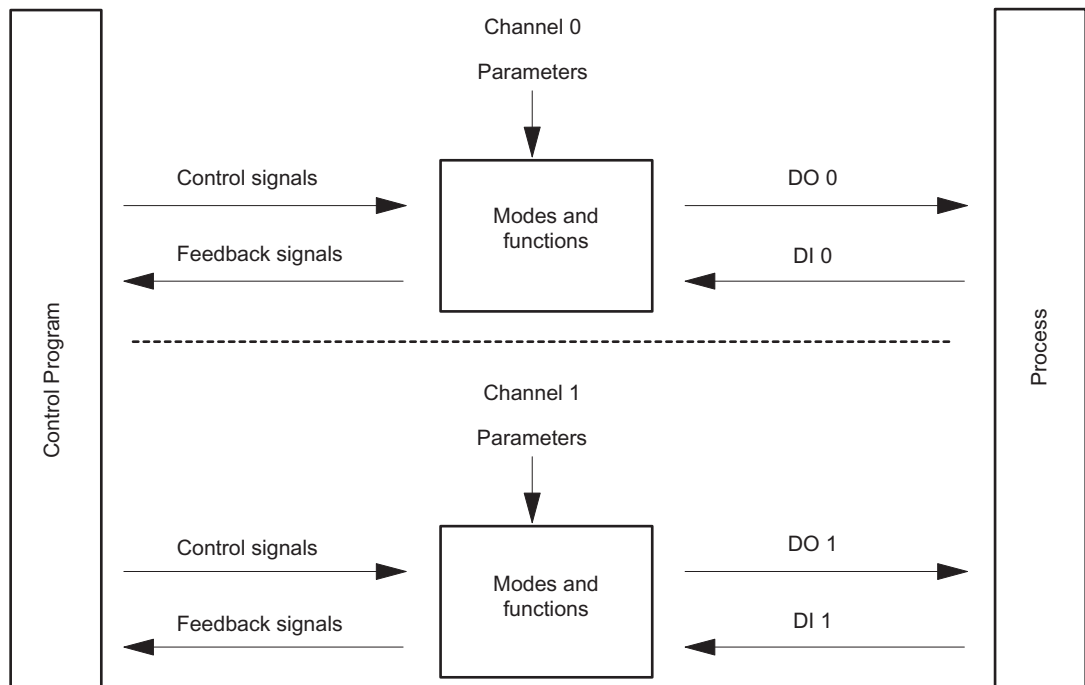

Figure 5-2 Operating principle of the 2PULSE

Interfaces to the Control Program and Process

To run the modes and execute functions, the 2PULSE has as an interface to the process of a digital input and a digital output for each channel (DI 0, DO 0 for Channel 0 and DI 1, DO1 for Channel 1).

You can modify and monitor the modes and functions with your control program using control signals and feedback signals.

Parameters are assigned to the various modes. You can find a complete list of parameters for all the operating modes in the section "Technical Specifications for Programming, Reference Lists (Page 353)".

You will find the following in the sections on modes and functions:

- The relevant parameters
- The control and feedback signals

The description of the modes and functions applies to both channels and the channels are therefore not referred to separately in the description.

5.4.2 "Pulse output" operating mode

Definition

For the pulse duration you set, the 2PULSE outputs a pulse at the DO digital output (output sequence) on expiration of the set on-delay.

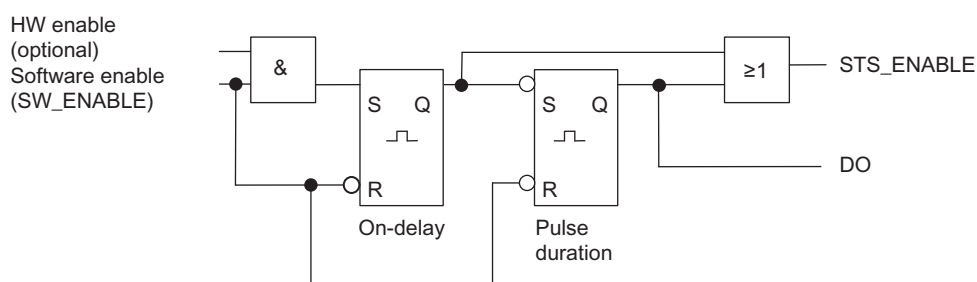

Figure 5-3 Block diagram for the "Pulse output" operating mode

Starting the Output Sequence

You must always issue the enable for the output sequence by means of the software enable (SW_ENABLE 0 → 1; MANUAL_DO = 0) in your control program.

The ACK_SW_ENABLE feedback bit indicates the software enable pending at the 2PULSE.

You can also set the DI digital input of the 2PULSE as a hardware enable (HW enable) with the "DI function" parameter.

If you want to work with the software enable and hardware enable at the same time, when the software enable has been issued, the output sequence starts at the first positive edge of the hardware enable. Further positive edges of the hardware enable during the current output sequence are ignored by the 2PULSE. When the software enable has been issued, a positive edge of the hardware enable is enough to start the next output sequence.

When the enable is issued (positive edge), the on-delay is started and the STS_ENABLE set. On expiration of the on-delay, the pulse is output with the set pulse duration. The output sequence finishes with the end of the pulse; STS_ENABLE is cleared.

If you make a prohibited change to the pulse duration during runtime, the ERR_PULS signal indicates a pulse output error. You will then have to restart the output sequence.

The next time the output sequence starts, the 2PULSE deletes the ERR_PULS feedback bit.

Pulse Diagram

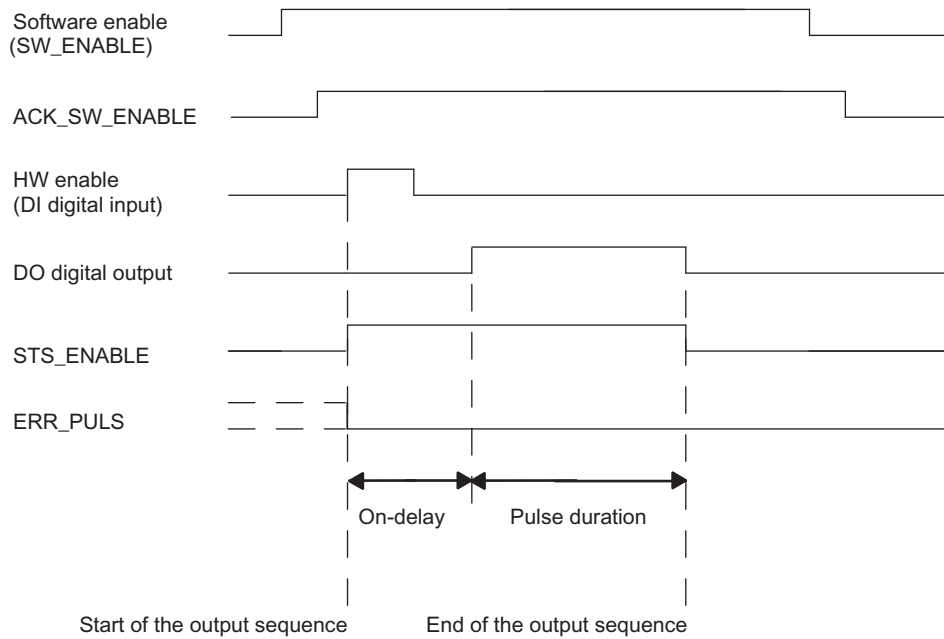

Figure 5-4 Output Sequence for Pulse Output

Canceling the Output Sequence

Deleting the software enable (SW_ENABLE = 0) during the on-delay or the pulse output cancels the output sequence, and STS_ENABLE and the DO digital output are canceled.

You will then have to restart the output sequence.

Truth Table

Software enable SW_ENABLE	Hardware enable (digital input DI)	DO Digital Output	STS_ENABLE	Output Sequence
1	0 → 1	0, if on-delay > 0 1, if on-delay = 0	0 → 1	Start
0 → 1	Not used	0, if on-delay > 0 1, if on-delay = 0	0 → 1	Start
0	Any status	0	0	Terminate
1	Any status	Previous status remains		-
0 → 1	0	0	0	-

Setting times using a time base

By means of the time base that can be assigned parameters, you can select the resolution and range of the pulse duration and the on-delay.

Time base = 0.1 ms:	You can set times from 0.2 ms to 6.5535 s with a resolution of 0.1 ms.
Time base = 1 ms:	You can set times from 1 ms to 65.535 s with a resolution of 1 ms.

Setting and Changing the Pulse Duration

Set the pulse duration directly in your control program as a numerical value between 0 and 65535.

Pulse duration = Time basis x Specified numerical value

If you change the pulse duration when an output sequence is running, the time already output will be subtracted from the new pulse duration and the pulse will continue to be output.

Reducing the Pulse Duration

If you have reduced the pulse duration to a time that is shorter than the time already output, the output sequence is terminated, STS_ENABLE and the DO digital output are deleted, and the ERR_PULS status bit is set. At the next output sequence, the ERR_PULS status bit is cleared.

Set the on-delay and change when using the short control interface

Set the on-delay as a value between 0 and 65535 in the parameters.

Configured on-delay = Time base x specified numerical value

Using the factor for the on-delay, you can adjust the time that has been assigned parameters in your control program. Set the factor between 0 and 255, with a weighting of 0.1:

On-delay = Factor x 0.1 x configured on-delay

If you change the on-delay factor during the output sequence, the new on-delay is activated at the next output sequence.

Isochronous mode

Generally applicable information is available in the section "Isochronous mode (Page 267)".

In the "Pulse output" operating mode, isochronous mode does not have any influence on the functionality.

Parameters of the "Pulse output" operating mode

Parameter	Meaning	Value Range	Default
Mode	Set the "Pulse output" operating mode.	<ul style="list-style-type: none"> • Pulse output • Pulse-width modulation • Pulse train • On/Off-delay • Frequency output 	Pulse width modulation
Time base	Using the time base, select the resolution and range of the pulse duration and the on-delay.	<ul style="list-style-type: none"> • 0.1 ms • 1 ms 	0.1 ms
Function DI	You can use the DI digital input as an input or as a hardware enable.	<ul style="list-style-type: none"> • Input • HW enable 	Input
On-delay ¹⁾	The time from the start of the output sequence to the output of the pulse. You can change the on-delay in your control program using the "On-delay factor".	0 to 65535	0

¹⁾ Only if the short control interface is used
 If the long control interface is used, enter this value directly in the control interface.

Control and feedback signals of the "Pulse output" operating mode

Control and Feedback Signals	Meaning	Value range	Channel 0 Address	Channel 1 Address
Control signals when the short control interface is used (8 bytes)				
Software enable SW_ENABLE	Starting and termination of the output sequence.	0 = SW_ENABLE canceled 1 = SW_ENABLE set 0→1 = start of output sequence; may be dependent on the hardware enable	Byte 2: Bit 0	Byte 6: Bit 0
Pulse duration	The time that is set for the DO digital output on expiration of the on-delay.	With time base 0.1 ms: 2 to 65535 With time base 1 ms: 1 to 65535 If you violate the low limit of the range, the 2PULSE will not output a pulse.	Word 0	Word 4
On-delay factor	The on-delay that has been assigned parameters can be changed before the start of the output sequence: On-delay = Factor x 0.1 x configured on-delay	0 to 255 If the on-delay < 0.2 ms or if factor = 0, the effective on-delay is = 0. If there is an on-delay > 65.535 s, the on-delay is limited to 65.535 s.	Byte 3	Byte 7

Control and Feedback Signals	Meaning	Value range	Channel 0 Address	Channel 1 Address
Control signals when the long control interface is used (12 bytes)				
Software enable SW_ENABLE	Starting and canceling of the output sequence.	0 = SW_ENABLE canceled 1 = SW_ENABLE set 0→1 = start of output sequence; may be dependent on the hardware enable	Byte 4: Bit 0	Byte 10: Bit 0
Pulse duration	The time that is set for the DO digital output on expiration of the on-delay.	With time base 0.1 ms: 2 to 65535 With time base 1 ms: 1 to 65535 If you violate the low limit of the range, the 2PULSE will not output a pulse.	Word 0	Word 6
On-delay	The on-delay can be changed before the start of the output sequence.	0 to 65535 On-delay = Time basis x Specified numerical value	Word 2	Word 8
Feedback Signals				
STS_ENABLE	Indicates an output sequence is running.	0 = pulse output blocked 1 = pulse output running	Byte 0: Bit 0	Byte 4: Bit 0
STS_DO	Indicates the signal level at the DO digital output. Note the update rate.	0 = signal at the DO digital output 1 = signal at the DO digital output	Byte 0: Bit 1	Byte 4: Bit 1
STS_DI	Indicates the signal level at the DI digital input.	0 = signal 0 at the DI digital input 1 = signal 1 at the DI digital input	Byte 0: Bit 2	Byte 4: Bit 2
ACK_SW_ENABLE	Indicates the status of SW_ENABLE.	0 = SW_ENABLE cleared. 1 = SW_ENABLE set	Byte 0: Bit 3	Byte 4: Bit 3
ERR_PULS	Indicates a pulse output error.	0 = no pulse output error 1 = pulse output error	Byte 0: Bit 4	Byte 4: Bit 4
SEQ_CNT	Is incremented after completion of an output sequence.	Without HW enable: 0 ... 1 With HW enable: 0 ... 15	Byte 1: Bit 0 to 3	Byte 5: Bit 0 to 3
Reserved	–	0	Word 2	Word 6

Input and output signals of "Pulse output" operating mode

Input and Output Signals	Meaning	Value range	Channel 0 Terminal	Channel 1 Terminal
Input Signal				
HW enable	You can select the HW enable with the "Function DI" parameter. The signal of the digital input DI is then interpreted by the 2PULSE at the start of the output sequence.	0 = HW enable cleared 1 = HW enable issued 0 → 1 = Start of the output sequence; dependent on the software enable (SW_ENABLE)	1	5
Output Signal				
Pulse at the DO digital output	A pulse is output at the DO digital output for the set pulse duration.	0 = no pulse 1 = pulse	4	8

5.4.3 "Pulse width modulation" operating mode

Definition

You specify an output value for the 2PULSE. The 2PULSE generates continuous pulses on this basis. The output value determines the pulse/interpulse ratio within a period (pulse-width modulation). The period can be adjusted.

The pulse train is output on expiration of the assigned on-delay on the DO digital output of the 2PULSE (output sequence).

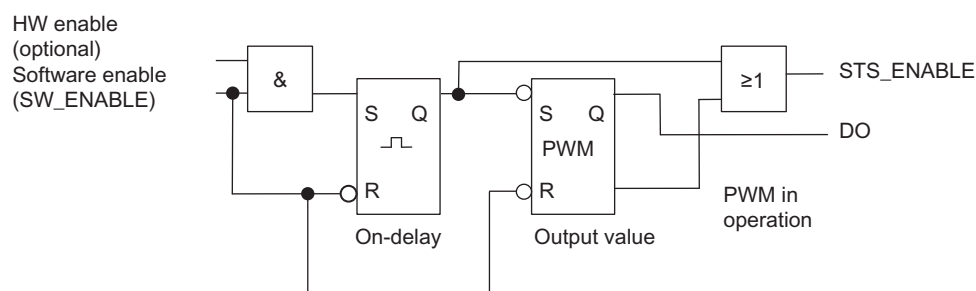

Figure 5-5 Block diagram for "Pulse width modulation" operating mode

Starting the output sequence

You must always issue the enable for the output sequence by means of the software enable (SW_ENABLE 0 → 1; MANUAL_DO = 0) in your control program.

The ACK_SW_ENABLE feedback bit indicates the software enable pending at the 2PULSE.

You can also set the digital input DI of the 2PULSE as a HW enable with the "Function DI" parameter. In isochronous mode, configuration of a HW enable has no effect.

If you want to work with the software enable and hardware enable at the same time, when the software enable has been issued, the output sequence starts with the first positive edge of the hardware enable. Further positive edges of the hardware enable during the current output sequence are ignored by the 2PULSE.

When the enable is issued (positive edge), the on-delay is started and the STS_ENABLE set. The pulse train is output on expiration of the on-delay. The output sequence runs continuously as long as SW_ENABLE is set.

Pulse Diagram

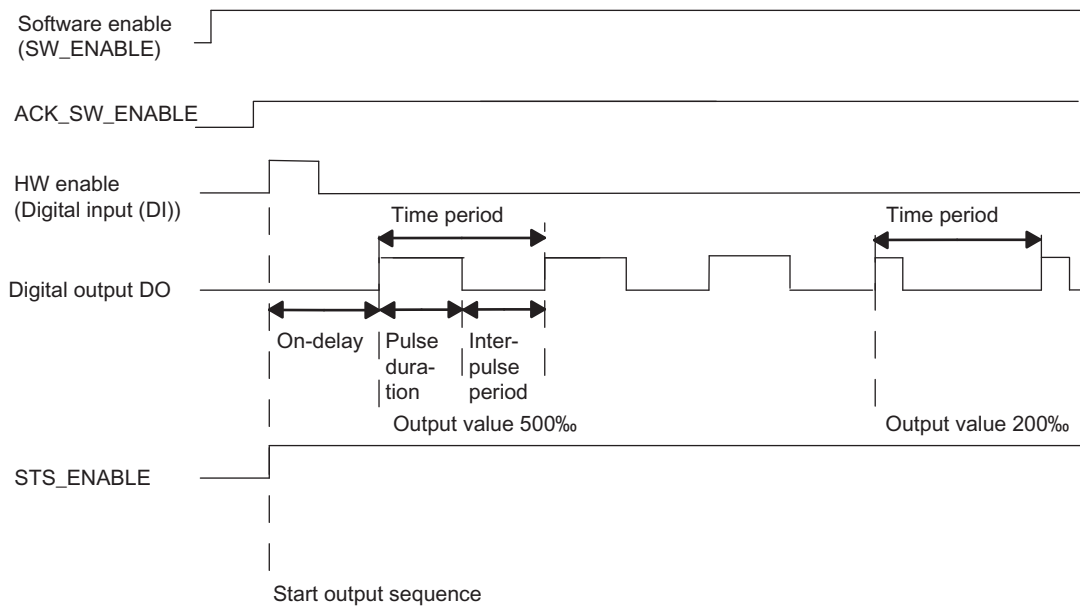

Figure 5-6 Pulse-Width Modulation Output Sequence

Canceling the output sequence

Deleting the software enable (SW_ENABLE = 0) during the on-delay or the pulse output cancels the output sequence, and STS_ENABLE and the DO digital output are canceled.

You will then have to restart the output sequence.

Truth table

Software enable SW_ENABLE	Hardware enable (digital input DI)	Digital output DO	STS_ENABLE	Output sequence
1	0 → 1	0, if on-delay > 0 1, if on-delay = 0	0 → 1	Start
0 → 1	Not used	0, if on-delay > 0 1, if on-delay = 0	0 → 1	Start
0	Any status	0	0	Cancel
1	Any status	Previous status remains		-
0 → 1	0	0	0	-

Minimum Pulse Duration and Minimum Interpulse Period

The minimum pulse duration and minimum interpulse period are superimposed on the proportional output characteristic.

You assign the minimum pulse duration and minimum interpulse period using the "Minimum pulse duration" parameter; they always have the same value.

A pulse duration calculated by the 2PULSE that is shorter than the minimum pulse duration is suppressed.

A pulse duration calculated by the 2PULSE that is longer than the period minus the minimum interpulse period is set at 1000‰.

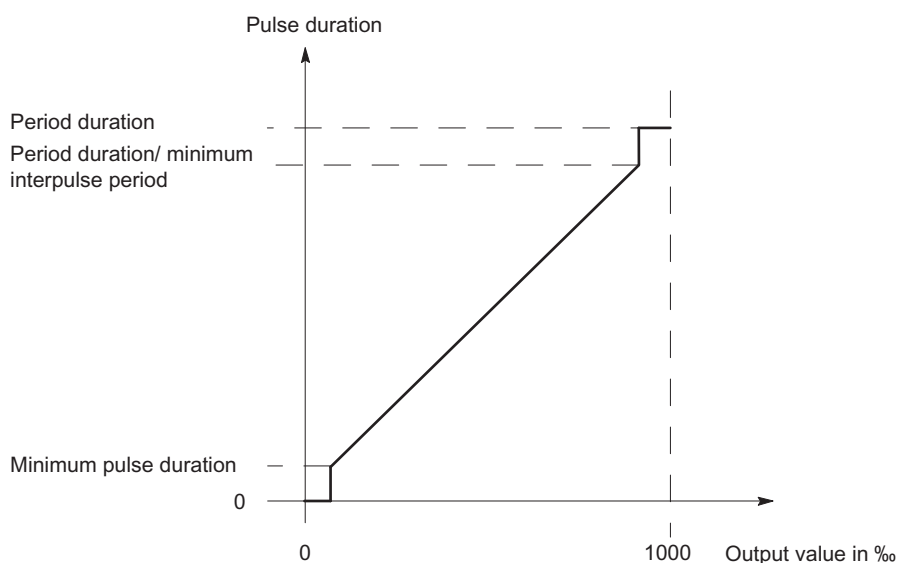

Figure 5-7 Modulation of the Pulse Duration

Setting Times Using a Time Base

You use the assignable time base to select the resolution and range of the period, the minimum pulse duration and the on-delay.

Time base = 0.1 ms:	You can set times from 0.2 ms to 6.5535 s with a resolution of 0.1 ms.
Time base = 1 ms:	You can set times from 1 ms to 65.535 s with a resolution of 1 ms.

Setting and Changing the Output Value

You select the range of the output value with the "Output format" parameter.

- Output format "Per mill": Value range between 0 and 1000

The 2PULSE uses this specified output value to calculate the pulse duration:

$$\text{Pulse duration} = (\text{output value}/1000) \times \text{time period.}$$

- "S7 analog output" output format: Value range between 0 and 27648

The 2PULSE uses this specified output value to calculate the pulse duration:

$$\text{Pulse duration} = (\text{output value}/27648) \times \text{time period.}$$

You set the output value directly using your control program. The new output value is applied at the next rising edge of the output.

Setting the time period

Depending on the configuration, the time period is specified as a parameter value or in the control interface. The table below shows when a specific value is used.

For isochronous mode, you have to specify the time period when parameters are assigned. In contrast to non-isochronous mode, you cannot change the time period later during runtime.

	Configuration with ...	
	Short control interface	Long control interface
Isochronous mode	Time period = "Time period" parameter value The value from the control interface is ignored.	
Non-isochronous mode	Time period = "Time period" parameter value × "Time period factor" from control interface	Time period = "Time period" setpoint from control interface The "Time period" parameter value is ignored.

Isochronous mode

Generally applicable information is available in the section "Isochronous mode (Page 267)".

The following particular aspects apply to isochronous mode in the "Pulse width modulation" operating mode:

- The output always begins without an on-delay, a configured on-delay is ignored.
- The output always begins after the software enable has been issued, a configured hardware enable is ignored.
- A change of the time period during runtime is not possible. Corresponding specifications via the control interface are ignored.

In isochronous mode, the output sequence is synchronized with the moment T_0 . The time period is coordinated to the DP cycle. It is possible that your defined time period cannot be implemented exactly.

The configured value of the time period is adjusted by the 2PULSE to the DP cycle based on a calculation algorithm. The calculation is performed to minimize the difference between the specified and calculated time period. In the most unfavorable case, the deviation amounts to half the DP cycle. The table below shows examples.

DP cycle time $T_{DP}^{1)}$	Specified time period $T_{Setpoint}$	Calculated time period $T_{Actual}^{1)}$
10 ms	5 ms	5 ms
10 ms	2 ms	2 ms
10 ms	6 ms	5 ms
10 ms	16 ms	20 ms

¹⁾ The calculated time period and the DP cycle time always have an integer ratio.

The correlation between the and the DP cycle is represented graphically below. The pulse-pause ratio is shown in the examples with 50% each. For additional information, refer to the Isochronous Mode (<http://support.automation.siemens.com/WW/view/en/15218045>) function manual.

- The time period is equal to the DP cycle

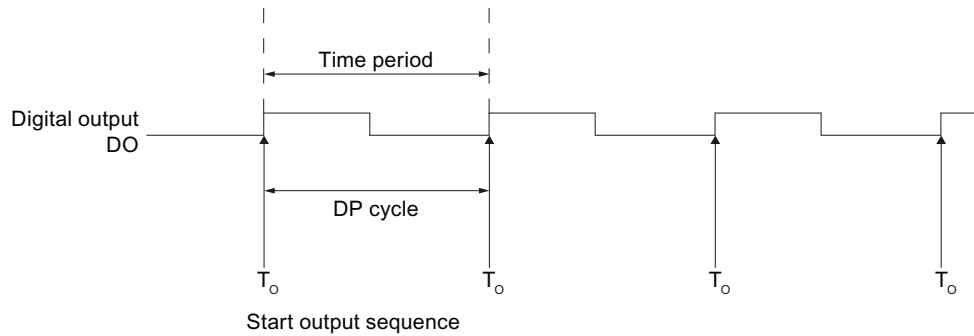

- The time period is less than the DP cycle

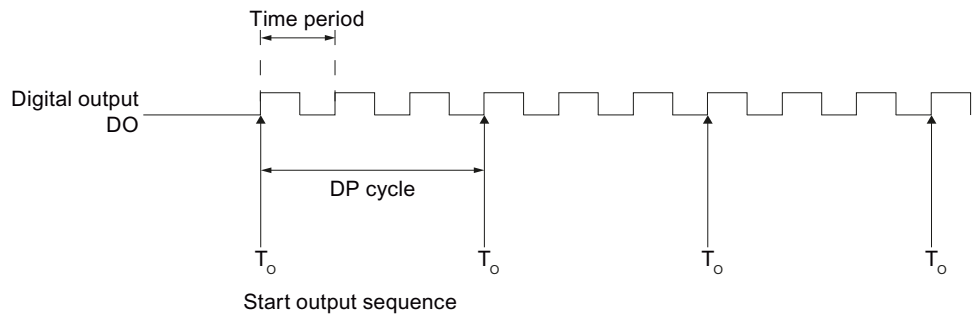

- The time period is greater than the DP cycle

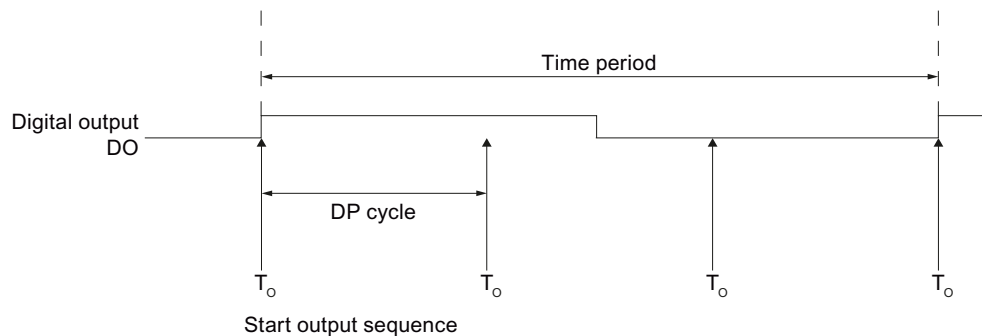

Time period at configuration with short control interface

You specify the time period in the parameters as a numerical value depending on the time base:

- With time base 1 ms: from 1 to 65535
- With time base 0.1 ms: from 2 to 65535

Configured time period = Time base x specified numerical value

Using the factor for the period duration, you can adjust the time that has been assigned parameters in your control program. Set the factor between 0 and 255, with a weighting of 0.1:

Time period = Factor x 0.1 x configured time period

The new setpoints for the time period are applied with the next rising edge of the output.

Note

If the time period changes in runtime, a brief minor increase in the time period can result (approx. 10 μ s).

Note

A change in the time period using the control interface has no effect in isochronous mode.

Setting the Minimum Pulse Duration and Minimum Interpulse Period

You specify the minimum pulse duration and the minimum interpulse period as a numerical value between 0 and 65535 using the "Minimum pulse duration" parameter:

Configured minimum pulse duration/minimum pause between pulses = Time base x specified numerical value

Setting the On-Delay

You specify the on-delay as a value between 0 and 65535 in the parameters.

Configured on-delay = Time base x specified numerical value

When the long control interface is used, the factor for the on-delay can be used to adjust the configured time in your control program. Set the factor between 0 and 255, with a weighting of 0.1:

On-delay = Factor x 0.1 x configured on-delay

Measurement of current

An important application for current measurement in the "Pulse width modulation" operating mode is the current regulation of a proportional valve. This allows you to compensate for thermal effects at the valve, for example.

For more information, refer to the section "Function: Measurement of current (Page 310)".

Parameters of the "Pulse width modulation" operating mode

Parameter	Meaning	Value range	Default
Operating mode	Set the "Pulse width modulation" operating mode.	<ul style="list-style-type: none"> Pulse output Pulse-width modulation Pulse train On/Off-delay Frequency output 	Pulse width modulation
Time base	Use the time base to select the resolution and the value range of the time period, the minimum pulse duration, and the on-delay.	<ul style="list-style-type: none"> 0.1 ms 1 ms 	0.1 ms
Output format	Choose between the Per mil, and the S7 analog output formats, depending on which output value resolution you need.	<ul style="list-style-type: none"> Per mill S7 analog output 	Per mill
Function DI	You can use the digital input DI as an input or as a HW enable.	<ul style="list-style-type: none"> Input HW enable 	Input
On-delay	The time from the start of the output sequence to the output of the pulse train.	0 to 65535	0
Minimum pulse duration	Minimum pulse duration and minimum interpulse period: Enter the response time of the actuator connected to your DO digital output.	0 to 65535	0
Time period ¹⁾	Setpoint of the time period When specifying the time period take into account the set minimum pulse duration and the response time of your final controlling element that is connected to the digital output DO. When the short control interface is used, you can use the "Time period factor" to change the time period in your control program in non-isochronous mode.	With time base 0.1 ms: 2 to 65535 With time base 1 ms: 1 to 65535	20000 → 2 s

¹⁾ Read the information provided above on "Setting the time period" and on "Isochronous mode".

Control and feedback signals of the "Pulse width modulation" operating mode

Control and feedback signals	Meaning	Value range	Channel 0 address	Channel 1 address
Control signals when the short control interface is used (8 bytes)				
Software enable SW_ENABLE	Starting and canceling of the output sequence.	0 = SW_ENABLE canceled 1 = SW_ENABLE set 0→1 = start of output sequence; may be dependent on the hardware enable	Byte 2: Bit 0	Byte 6: Bit 0
Output value	The value that is output in pulse-width modulated format on the digital output DO.	Depending on the output format: <ul style="list-style-type: none"> Per mill: 0 ... 1000 S7 analog output: 0 to 27648 If you enter an output value > 1000 or 27648, the 2PULSE limits this to 1000 or 27648.	Word 0	Word 4
Period duration factor	You can change the assigned period: Time period = Factor x 0.1 x configured time period	Factor: 0 to 255 Period duration: 2 x Minimum pulse duration up to 65.635 s. If a period duration of < 2 x minimum pulse duration occurs or < 2 μs or if Factor = 0, the effective period = 2 x minimum pulse duration, but at least 200 μs. If there is a period > 65.535 s, it is limited to 65.535 s.	Byte 3	Byte 7
Control signals when the long control interface is used (12 bytes)				
Software enable SW_ENABLE	Starting and canceling of the output sequence.	0 = SW_ENABLE canceled 1 = SW_ENABLE set 0→1 = start of output sequence; may be dependent on the hardware enable	Byte 4: Bit 0	Byte 10: Bit 0
Output value	The value that is output in pulse-width modulated format on the digital output DO.	Depending on the output format: <ul style="list-style-type: none"> Per mill: 0 ... 1000 S7 analog output: 0 to 27648 If you enter an output value > 1000 or 27648, the 2PULSE limits this to 1000 or 27648.	Word 0	Word 6
Time period ¹⁾	Setpoint of the time period in non-isochronous mode	With time base 0.1 ms: 2 to 65535 With time base 1 ms: 1 to 65535	Word 2	Word 8
On-delay factor	The on-delay that has been assigned parameters can be changed before the start of the output sequence: On-delay = Factor x 0.1 x configured on-delay	0 to 255 If the on-delay < 0.2 ms or if factor = 0, the effective on-delay is = 0. If there is an on-delay > 65.535 s, the on-delay is limited to 65.535 s.	Byte 5	Byte 11

Control and feedback signals	Meaning	Value range	Channel 0 address	Channel 1 address
Feedback signals				
STS_ENABLE	Indicates an output sequence is running.	0 = Pulse output blocked 1 = Pulse output running	Byte 0: Bit 0	Byte 4: Bit 0
STS_DO	Indicates the signal level at the digital output DO. Note the update rate.	0 = Signal 0 on digital output DO 1 = Signal 1 on digital output DO	Byte 0: Bit 1	Byte 4: Bit 1
STS_DI	Indicates the signal level at digital input DI.	0 = Signal 0 on digital input DI 1 = Signal 1 on digital input DI	Byte 0: Bit 2	Byte 4: Bit 2
ACK_SW_ENABLE	Indicates the status of SW_ENABLE.	0 = SW_ENABLE cleared. 1 = SW_ENABLE set	Byte 0: Bit 3	Byte 4: Bit 3
SEQ_CNT	No function in this operating mode.	–	Byte 1: Bit 0 to 3	Byte 5: Bit 0 to 3
Measured value of the current	Current at the DO as a SIMATIC S7 analog value.	0 to 27648 (overrange up to 32767)	Word 2	Word 6

1) Read the information provided above on "Setting the time period".

Input and output signals of the "Pulse width modulation" operating mode

Input and output signal	Meaning	Value range	Channel 0 terminal	Channel 1 terminal
Input signal				
HW enable	You can select the HW enable with the "Function DI" parameter. The signal of the digital input DI is then interpreted by the 2PULSE at the start of the output sequence.	0 = HW enable cleared 1 = HW enable issued 0 → 1 = Start of the output sequence; dependent on the software enable	1	5
Output signal				
Pulse train on the digital output DO	The pulse train is output on the digital output DO.	0 = no pulse 1 = pulse	4	8

5.4.4 "Pulse train" operating mode

Definition

The 2PULSE outputs the number of pulses you specified as a pulse train at the DO digital output on expiration of the set on-delay (output sequence). The period duration and pulse duration of the pulses can be adjusted.

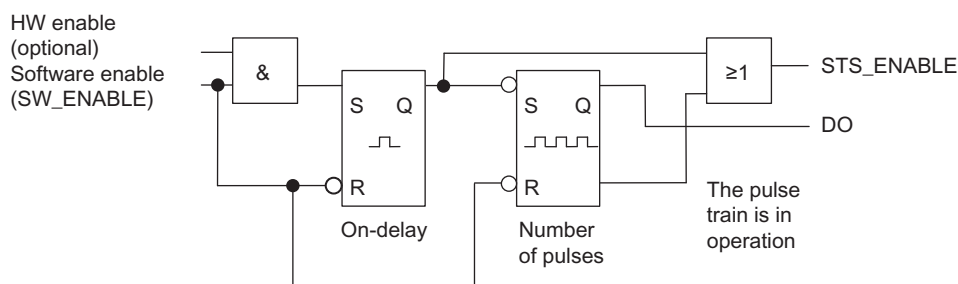

Figure 5-8 Block diagram for "Pulse Train" operating mode

Starting the output sequence

You must always issue the enable for the output sequence by means of the software enable (SW_ENABLE 0 → 1; MANUAL_DO = 0) in your control program. The ACK_SW_ENABLE feedback bit indicates the software enable pending at the 2PULSE.

You can also set the digital input DI of the 2PULSE as a HW enable with the "Function DI" parameter.

If you want to work with the software enable and hardware enable at the same time, when the software enable has been issued, the output sequence starts with the first positive edge of the hardware enable. Further positive edges of the hardware enable during the current output sequence are ignored by the 2PULSE. When the software enable has been issued, a positive edge of the hardware enable is enough to start the next output sequence.

When the enable is issued (positive edge), the on-delay is started and the STS_ENABLE set. On expiration of the on-delay, the pulse train is output with the set number of pulses. The output sequence finishes as soon as the last pulse has been output; STS_ENABLE is cleared.

If you make a prohibited change to the number of pulses during runtime, the ERR_PULS signal indicates a pulse output error.

At the next output sequence, the 2PULSE deletes the ERR_PULS feedback bit.

Pulse diagram

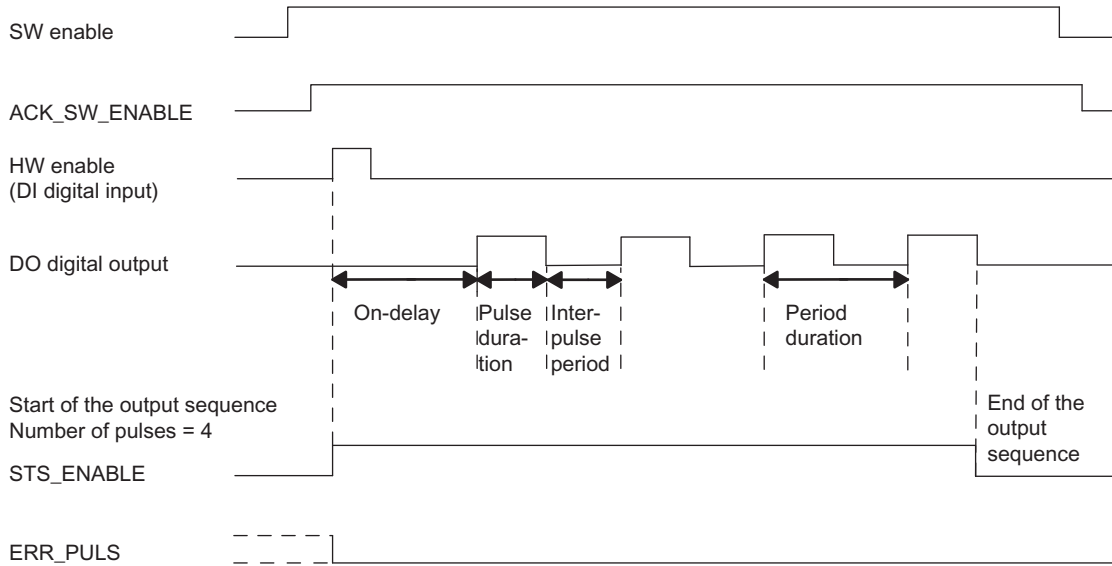

Figure 5-9 Output Sequence of the Pulse Train

Canceling the output sequence

Deleting the software enable during the on-delay or the pulse train terminates the output sequence, and STS_ENABLE and the DO digital output are deleted.

You will then have to restart the output sequence.

Truth table

Software enable SW_ENABLE	Hardware enable (digital input DI)	Digital output DO	STS_ENABLE	Output sequence
1	0 → 1	0, if on-delay > 0 1, if on-delay = 0	0 → 1	Start
0 → 1	Not used	0, if on-delay > 0 1, if on-delay = 0	0 → 1	Start
0	Any status	0	0	Cancel
1	Any status	Previous status remains		-
0 → 1	0	0	0	-

Setting times using a time base

Select, by means of the time base that can be assigned parameters, the resolution and range of the period duration, the pulse duration, and the on-delay.

Time base = 0.1 ms:	You can set times from 0.2 ms to 6.5535 s with a resolution of 0.1 ms.
Time base = 1 ms:	You can set times from 1 ms to 65.535 s with a resolution of 1 ms.

Setting and Changing the Number of Pulses

Set the number of pulses directly as a numerical value between 0 and 65535 with your control program.

If you change the number of pulses on expiration of the on-delay, the new value takes effect immediately:

- If you have increased the number of pulses, the new, higher number of pulses is output.
- If you have reduced the number of pulses, and if the lower number of pulses has already been output, the output sequence is terminated, STS_ENABLE and the DO digital output are deleted, and ERR_PULS is set. At the next output sequence, ERR_PULS is cleared.

Set the time period and change when using the short control interface

Set the period duration as a value between 2 and 65535 in the parameters:

Configured time period = Time base x specified numerical value

Using the factor for the period, you can adjust the assigned time in your control program. Set the factor between 0 and 255, with a weighting of 0.1:

Time period = Factor x 0.1 x configured time period

If you change the factor during the output sequence, the new period duration will take effect at the start of the next output sequence.

Setting the Pulse Duration

Set the pulse duration as a numerical value between 1 and 65535 with the "Pulse duration" parameter:

Configured pulse duration = Time base x Specified numerical value

When the long control interface is used, you can set the ratio of the pulse duration to the interpulse period:

Pulse-pause ratio = (Setpoint / 255) × time period

Setting the On-Delay

Set the on-delay as a value between 0 and 65535 in the parameters.

Configured on-delay = Time base x specified numerical value

Isochronous mode

Generally applicable information is available in the section "Isochronous mode (Page 267)".

In the "Pulse train" operating mode, isochronous mode does not have any influence on the functionality.

Measurement of current

For more information, refer to the section "Function: Measurement of current (Page 310)".

Parameters of the "Pulse train" operating mode

Parameter	Meaning	Value range	Default
Operating mode	Set the "Pulse train" operating mode.	<ul style="list-style-type: none"> • Pulse output • Pulse width modulation • Pulse train • On/Off-delay • Frequency output 	Pulse width modulation
Time base	Using the time base, select the resolution and range of the period duration, pulse duration, and on-delay.	<ul style="list-style-type: none"> • 0.1 ms • 1 ms 	0.1 ms
Function DI	You can use the DI digital input as an input or as a HW enable.	<ul style="list-style-type: none"> • Input • HW enable 	Input
On-delay	The time from the start of the output sequence to the output of the pulse train.	0 to 65535	0
Pulse duration ¹⁾	Pulse duration: Enter the response time of the actuator connected on your DO digital output.	With time base 0.1 ms: 2 to 65535 With time base 1 ms: 1 to 65535 If you violate the low limit of the range, the 2PULSE sets the pulse duration to 0.2 ms or 1 ms.	10000 → 1 s
Time period ¹⁾	The period duration should always be a multiple of the response time of the actuator connected to the DO digital output. Define the period duration according to the required repetition rate of the pulses. You can change the time period in your control program using the "Time period factor".	With time base 0.1 ms: 2 to 65535 With time base 1 ms: 1 to 65535	20000 → 2 s

¹⁾ Only if the short control interface is used
 If the long control interface is used, enter this value directly in the control interface.

Control and feedback signals of the "Pulse train" operating mode

Control and feedback signals	Meaning	Value range	Channel 0 address	Channel 1 address
Control signals when the short control interface is used (8 bytes)				
Software enable SW_ENABLE	Starting and canceling of the output sequence.	0 = SW_ENABLE cleared. 1 = SW_ENABLE set 0 → 1 = Start of the output sequence; may be dependent on the HW enable	Byte 2: Bit 0	Byte 6: Bit 0
Number of pulses	Number of pulses that are output at the DO digital output on expiration of the on-delay.	0 to 65535 If the number of pulses is 0, the 2PULSE does not output any pulses. The output sequence is terminated with ERR_PULS = 1.	Word 0	Word 4
Period duration factor	The on-delay that can be assigned before the start of the output sequence: Time period = Factor x 0.1 x configured time period	Factor: 0 to 255 Period duration: > Pulse duration up to 65.535 s If there is a period duration > 65.535 s, it is set to 65.535 s. If a period duration ≤ pulse duration, it is set to a pulse duration of + 0.2 ms (or pulse duration + 1 ms).	Byte 3	Byte 7
Control signals when the long control interface is used (12 bytes)				
Software enable SW_ENABLE	Starting and canceling of the output sequence.	0 = SW_ENABLE cleared. 1 = SW_ENABLE set 0 → 1 = Start of the output sequence; may be dependent on the HW enable	Byte 4: Bit 0	Byte 10: Bit 0
Number of pulses	Number of pulses that are output at the DO digital output on expiration of the on-delay.	0 to 65535 If the number of pulses is 0, the 2PULSE does not output any pulses. The output sequence is terminated with ERR_PULS = 1.	Word 0	Word 6
Period duration	Setpoint of the time period	With time base 0.1 ms: 2 to 65535 With time base 1 ms: 1 to 65535	Word 2	Word 8
Pulse-pause ratio	You can set the ratio of the pulse duration to the interpulse period	0 to 255 E.g the value of 128 corresponds to a ratio of 50:50.	Byte 5	Byte 11

Control and feedback signals	Meaning	Value range	Channel 0 address	Channel 1 address
Feedback signals				
STS_ENABLE	Indicates an output sequence is running.	0 = pulse output blocked 1 = pulse output running	Byte 0: Bit 0	Byte 4: Bit 0
STS_DO	Indicates the signal level at the digital output DO. Note the update rate.	0 = Signal 0 on digital output DO 1 = Signal 1 on digital output DO	Byte 0: Bit 1	Byte 4: Bit 1
STS_DI	Indicates the signal level at digital input DI.	0 = Signal 0 on digital input DI 1 = Signal 1 on digital input DI	Byte 0: Bit 2	Byte 4: Bit 2
ACK_SW_ENABLE	Indicates the status of SW_ENABLE.	0 = SW_ENABLE cleared. 1 = SW_ENABLE set	Byte 0: Bit 3	Byte 4: Bit 3
ERR_PULS	Indicates a pulse output error.	0 = no pulse output error 1 = pulse output error	Byte 0: Bit 4	Byte 4: Bit 4
SEQ_CNT	Is incremented after completion of an output sequence.	Without HW enable: 0 ... 1 With HW enable: 0 ... 15	Byte 1: Bit 0 to 3	Byte 5: Bit 0 to 3
Measured value of the current	Current at the DO as a SIMATIC S7 analog value.	0 to 27648 (overrange up to 32767)	Word 2	Word 6

Input and output signals of "Pulse train" operating mode

Input and output signal	Meaning	Value range	Channel 0 terminal	Channel 1 terminal
Input signal				
HW enable	You can select the HW enable with the "Function DI" parameter. The signal of the digital input DI is then interpreted by the 2PULSE at the start.	0 = HW enable cleared 1 = HW enable issued 0 → 1 = Start of the output sequence; dependent on the software enable (SW_ENABLE)	1	5
Output Signal				
Pulse train at the DO digital output	The preset number of pulses is output at the DO digital output.	0 = no pulse 1 = pulse	4	8

5.4.5 "On/Off-delay" operating mode

Definition

The signal pending at the digital input DI is output with an on/off-delay at the digital output DO by the 2PULSE.

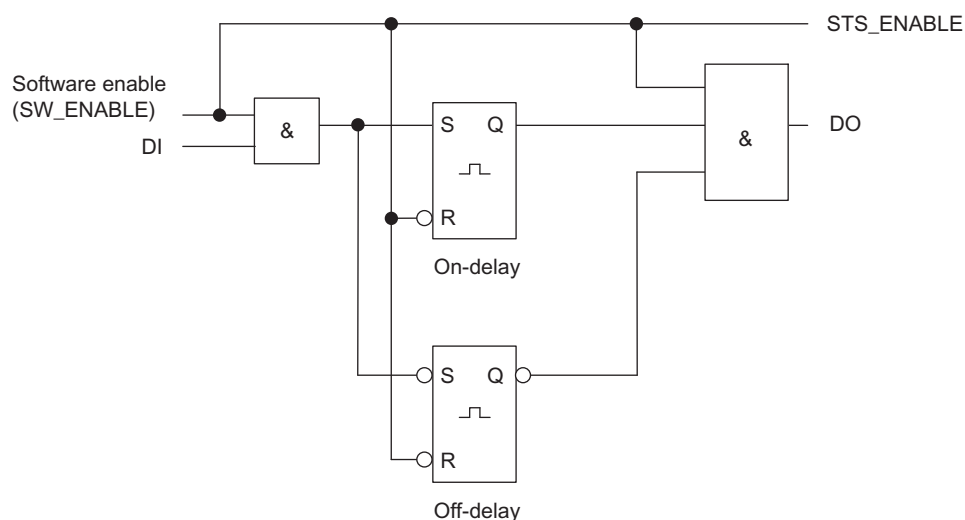

Figure 5-10 Block diagram for "On/Off-delay" mode

Output Sequence Enable

You must always issue the enable for the output sequence by means of the software enable (SW_ENABLE 0 → 1; MANUAL_DO = 0) in your control program, STS_ENABLE is then set. The ACK_SW_ENABLE feedback bit indicates the software enable pending at the 2PULSE.

The positive edge on the DI digital input (0 → 1) starts the on-delay, and the DO digital output is set on expiration of the on-delay.

The negative edge on the DI digital input (1 → 0) starts the off-delay, and the DO digital output is deleted on expiration of the off-delay.

If the 2PULSE recognizes a pulse duration or interpulse period that is too short, this is displayed by the ERR_PULS pulse output error.

At the next edge at the DI digital input, the 2PULSE deletes the ERR_PULS feedback bit.

Pulse Diagram

SW_ENABLE is set, while DI = 0:

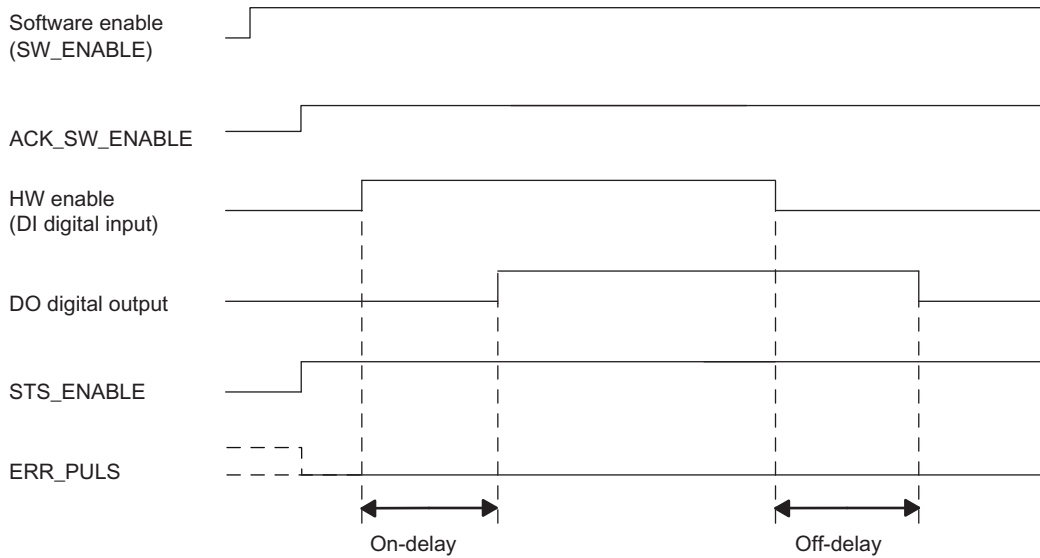

Figure 5-11 Output sequence on/off-delay (at the start DI = 0)

SW_ENABLE is set, while DI = 1:

If SW_ENABLE is set while DI = 1, the first edge at DI (falling edge) is ignored.

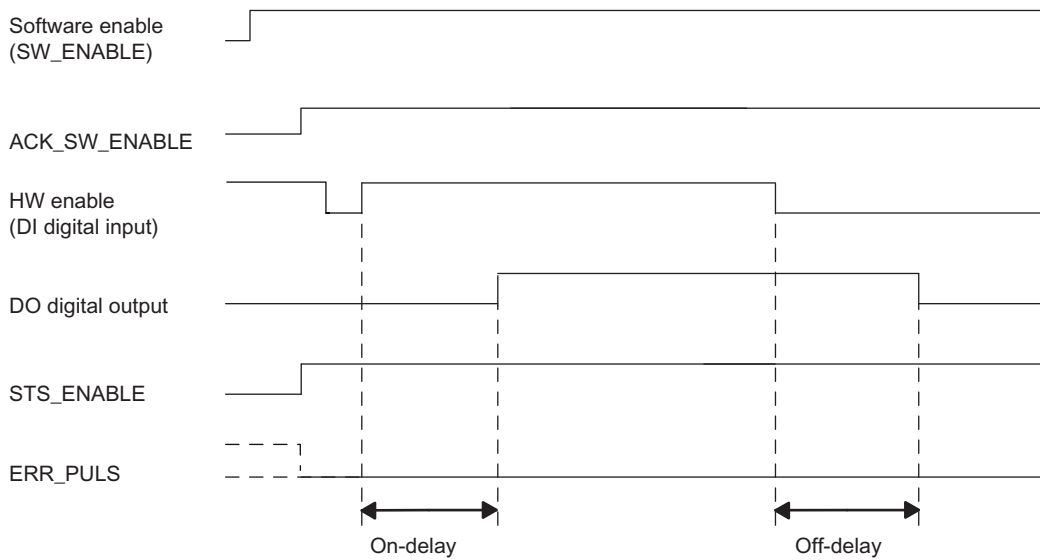

Figure 5-12 Output sequence on/off-delay (at the start DI = 1)

Canceling the Output Sequence

Clearing the software enable (SW_ENABLE = 0) during the output sequence causes the output sequence to be aborted, along with STS_ENABLE and the digital output.

Truth Table

Software enable SW_ENABLE	Digital input DI	Digital output DO	STS_ENABLE	Output sequence
1	0 → 1	0, if on-delay > 0 1, if on-delay = 0	1	Start
1	1 → 0	1, if off-delay > 0 0, if off-delay = 0	1	Start
0	Any status	0	0	Cancel
1	Any status	Previous status remains	1	-
0 → 1	0	0	1	-

Minimum Pulse Duration/Minimum Interpulse Period of the Digital Output DO

The minimum pulse duration/minimum interpulse period of the digital output DO amounts to 100 µs.

Make sure you take this into consideration when you set the on/off-delay and the pulse duration/interpulse period of the digital input DI; otherwise, the response at the digital output DO is not defined.

The Pulse Duration of the Digital Input DI Is Too Short

The 2PULSE detects a pulse that is too short on the negative edge on the digital input DI if:

Pulse duration + Off-delay ≤ On-delay.

Response of the 2PULSE to a pulse duration that is too short:

- ERR_PULS is set
- The current on-delay is deleted.
- The Off-delay is not started.
- The signal level at the digital output DO remains at 0.

ERR_PULS is deleted at the next positive edge on the digital input DI.

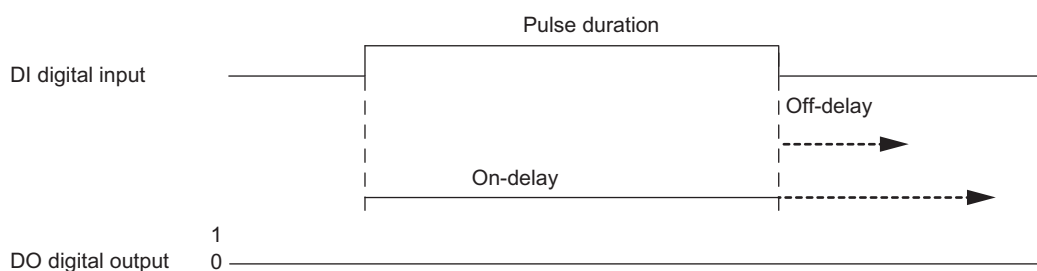

Figure 5-13 The Pulse Duration Is Too Short

The Interpulse Period of the Digital Input DI Is Too Short

The 2PULSE detects an interpulse period that is too short on the positive edge on the digital input DI if:

Interpulse period + on-delay \leq Off-delay.

Response of the 2PULSE to a interpulse period that is too short:

- ERR_PULS is set
- The current Off-delay is deleted.
- The on-delay is not started.
- The signal level at the digital output DO remains at 1.

ERR_PULS is deleted with the next negative edge on the digital input DI.

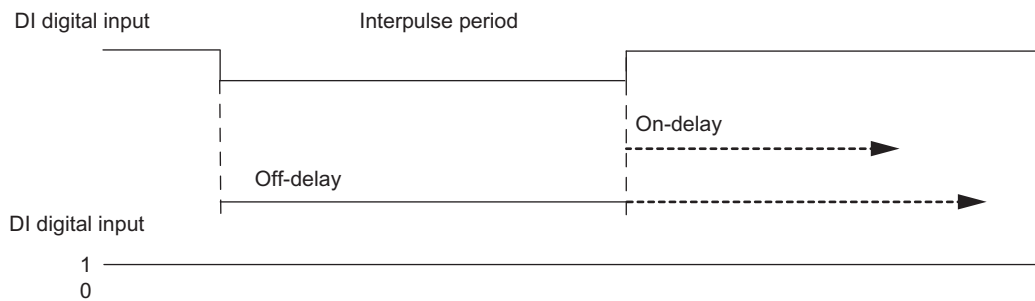

Figure 5-14 The Interpulse Period Is Too Short

Retriggering the current on-delay

The 2PULSE starts a new on-delay on the positive edge on the digital input DI if:

On-delay > pulse duration + interpulse period

This deletes the current Off-delay.

The digital output DO is only set if signal level 1 is present on the digital input DI longer than the on-delay. This enables you to filter rapid pulse trains.

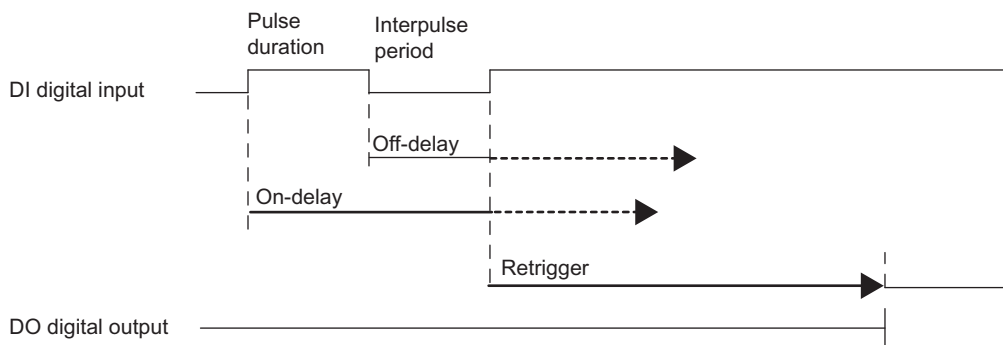

Figure 5-15 Retriggering the current on-delay

Retriggering the current Off-delay

The 2PULSE starts a new off-delay on the negative edge on the digital input DI if:

Off-delay > pulse duration + interpulse period.

This deletes the current on-delay.

The digital output DO is only deleted if signal level 0 is present on the digital input DI longer than the off-delay.

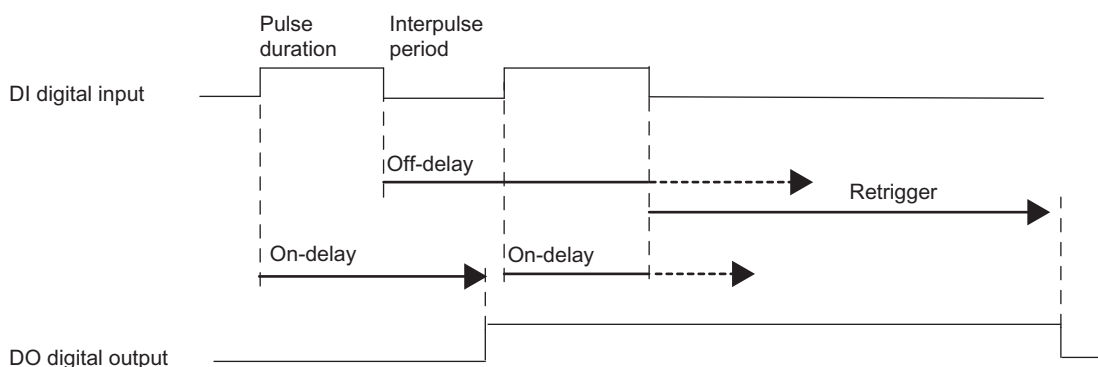

Figure 5-16 Retriggering the current Off-delay

Setting Times Using a Time Base

Use the assigned time base to select the resolution and the value range of the on-delay and the off-delay.

Time base = 0.1 ms:	You can set times from 0.2 ms to 6.5535 s with a resolution of 0.1 ms.
Time base = 1 ms:	You can set times from 1 ms to 65.535 s with a resolution of 1 ms.

Set the on-delay and change when using the short control interface

You specify the on-delay as a value between 0 and 65535 in the parameters.

Configured on-delay = Time base x specified numerical value

Using the factor for the on-delay, you can adjust the assigned time in your control program. Set the factor between 0 and 255, with a weighting of 0.1:

On-delay = Factor x 0.1 x configured on-delay

If you change the on-delay factor, the new on-delay is activated with the next positive edge on the digital input DI.

Setting and changing the off-delay

Set the off-delay directly as a numerical value between 0 and 65535 in your control program.

Off-delay = Time base x Specified numerical value

If you change the off-delay factor, the new Off-delay is activated with the next negative edge on the digital input DI.

Isochronous mode

Generally applicable information is available in the section "Isochronous mode (Page 267)".

In the "On/Off-delay" operating mode, isochronous mode does not have any influence on the functionality.

Parameters for the "On/Off-delay" operating mode

Parameter	Meaning	Value Range	Default
Mode	Set the "On/Off-delay" operating mode.	<ul style="list-style-type: none"> • Pulse output • Pulse-width modulation • Pulse train • On/Off-delay • Frequency output 	Pulse width modulation
Time base	Use the time base to select the resolution and the value range of the on-delay and Off-delay.	<ul style="list-style-type: none"> • 0.1 ms • 1 ms 	0.1 ms
On-delay ¹⁾	The time between a positive edge of digital input DI and its output on the digital output DO. You can change the on-delay with your control program with "On-delay factor".	0 to 65535	0

¹⁾ Only if the short control interface is used
If the long control interface is used, enter this value directly in the control interface.

Control and feedback signals of the "On/Off-delay" operating mode

Control and Feedback Signals	Meaning	Value range	Channel 0 address	Channel 1 address
Control signals when the short control interface is used (8 bytes)				
Software enable SW_ENABLE	You must always issue the software enable in your control program. If you cancel the software enable, the current output sequence will be canceled.	0 = SW_ENABLE cleared. 1 = SW_ENABLE set	Byte 2: Bit 0	Byte 6: Bit 0
Off-delay	The time between a negative edge of the digital input DI and its output on the digital output DO.	With time base 0.1 ms: 2 to 65535 With time base 1 ms: 1 bis 65535 If you violate the lower limit of the range, the off-delay will not function.	Word 0	Word 4
On-delay factor	You can change the assigned on-delay: On-delay = Factor x 0.1 x configured on-delay	Factor: 0 to 255 On-delay: 0.2 ms to 65.535 s If the on-delay is < 0.2 ms or if the factor = 0, the effective on-delay = 0. If the on-delay is > 65.535 s, the on-delay is limited to 65.535 s.	Byte 3	Byte 7
Control signals when the long control interface is used (12 bytes)				
Software enable SW_ENABLE	You must always issue the software enable in your control program. If you cancel the software enable, the current output sequence will be canceled.	0 = SW_ENABLE cleared. 1 = SW_ENABLE set	Byte 4: Bit 0	Byte 10: Bit 0
Off-delay	The time between a negative edge of the digital input DI and its output on the digital output DO.	With time base 0.1 ms: 2 to 65535 With time base 1 ms: 1 to 65535 If you violate the low limit of the range, the off-delay will not function.	Word 0	Word 6
On-delay	The time between a positive edge of the digital input DI and its output on the digital output DO.	With time base 0.1 ms: 2 to 65535 With time base 1 ms: 1 to 65535 If you violate the low limit of the range, the on-delay will not function.	Word 2	Word 8

Control and Feedback Signals	Meaning	Value range	Channel 0 address	Channel 1 address
Feedback signals				
STS_ENABLE	Indicates the status of the software enable (SW_ENABLE).	0 = software enable blocked 1 = software enable issued	Byte 0: Bit 0	Byte 4: Bit 0
STS_DO	Indicates the signal level at the digital output DO. Note the update rate.	0 = signal 0 on digital output DO 1 = signal 1 on digital output DO	Byte 0: Bit 1	Byte 4: Bit 1
STS_DI	Indicates the signal level at digital input DI.	0 = signal 0 on digital input DI 1 = signal 1 on digital input DI	Byte 0: Bit 2	Byte 4: Bit 2
ACK_SW_ENABLE	Indicates the status of SW_ENABLE.	0 = SW_ENABLE cleared. 1 = SW_ENABLE set	Byte 0: Bit 3	Byte 4: Bit 3
ERR_PULS	Indicates a pulse output error if the pulse duration or interpulse period is too short.	0 = no pulse output error 1 = pulse output error	Byte 0: Bit 4	Byte 4: Bit 4
SEQ_CNT	Is incremented at DO with each edge (positive and negative).	0 ... 15	Byte 1: Bit 0 to 3	Byte 5: Bit 0 to 3
Measured value of the current	No function in this operating mode.	0	Word 2	Word 6

Input and output signals of the "On/Off-delay" operating mode

Input and Output Signals	Meaning	Value Range	Channel 0 terminal	Channel 1 terminal
Input signal				
Digital input DI	The signal of the digital input DI is output with an on/off-delay on digital output DO by the 2PULSE.	0 = no pulse 1 = pulse	1	5
Output signal				
Pulse on the digital output DO	The signal of the digital input DI is output with an on/off-delay on digital output DO by the 2PULSE.	0 = no signal 1 = signal	4	8

5.4.6 "Frequency output" operating mode

Definition

A square wave signal with a specified frequency is output at the digital output of the 2PULSE.

The output sequence is started on expiration of the configured on-delay on the DO digital output of the 2PULSE.

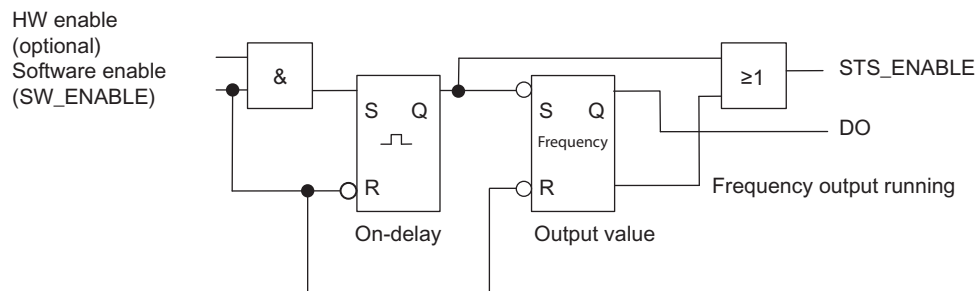

Figure 5-17 Block diagram for "Frequency output" operating mode

Starting the Output Sequence

You must always issue the enable for the output sequence by means of the software enable (SW_ENABLE 0 → 1; MANUAL_DO = 0) in your control program.

The ACK_SW_ENABLE feedback bit indicates the software enable pending at the 2PULSE.

You can also set the digital input DI of the 2PULSE as a HW enable with the "Function DI" parameter.

If you want to work with the software enable and hardware enable at the same time, when the software enable has been issued, the output sequence starts with the first positive edge of the hardware enable. Further positive edges of the hardware enable during the current output sequence are ignored by the 2PULSE.

When the enable is issued (positive edge), the on-delay is started and the STS_ENABLE set. The frequency output is started on expiration of the on-delay time. The output sequence runs continuously as long as SW_ENABLE is set.

Pulse diagram

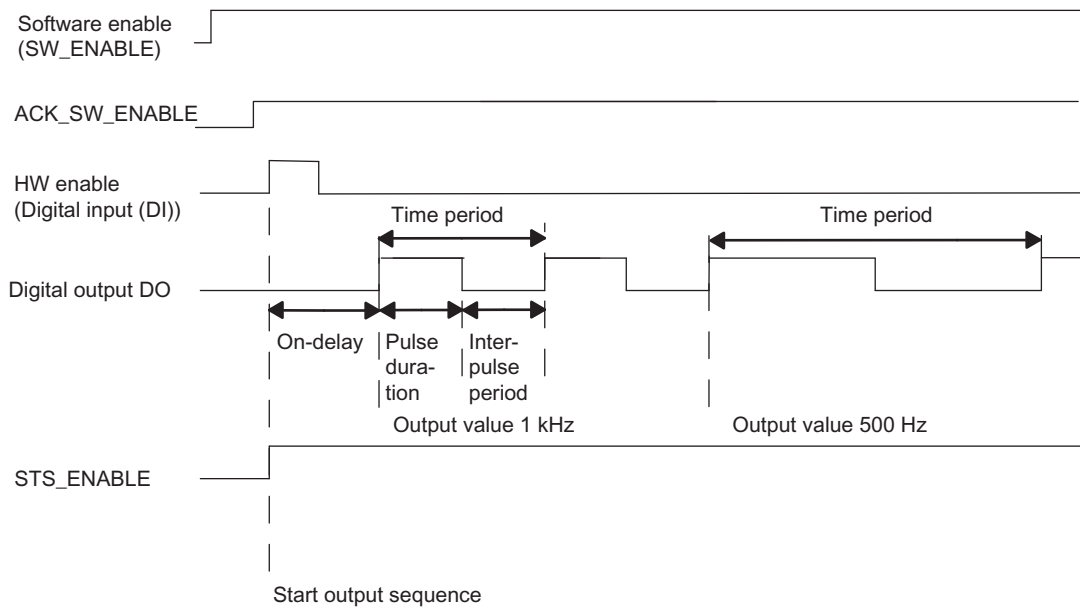

Figure 5-18 Output sequence frequency output

Canceling the output sequence

Deleting the software enable (SW_ENABLE = 0) during the on-delay or the frequency output cancels the output sequence, and STS_ENABLE and the DO digital output are canceled.

You will then have to restart the output sequence.

Truth Table

Software enable SW_ENABLE	Hardware enable (digital input DI)	Digital output DO	STS_ENABLE	Output sequence
1	0 → 1	0, if on-delay > 0 1, if on-delay = 0	0 → 1	Start
0 → 1	Not used	0, if on-delay > 0 1, if on-delay = 0	0 → 1	Start
0	Any status	0	0	Cancel
1	Any status	Previous status remains		-
0 → 1	0	0	0	-

Setting Times Using a Time Base

Use the configured time base to select the resolution and the value range of the on-delay.

Time base = 0.1 ms:	You can set times from 0.2 ms to 6.5535 s with a resolution of 0.1 ms.
Time base = 1 ms:	You can set times from 1 ms to 65.535 s with a resolution of 1 ms.

Setting and Changing the Output Value

You select the range of the output value with the "Output format" parameter.

- If your output value is between 1 Hz and 5000 Hz, select the output format "1 Hz".
- If your output value is a SIMATIC S7 analog value (between 0 and 27648), select the "S7 analog output" output format. With "S7 analog output" you attain a higher accuracy at the setpoint specification.

The 2PULSE calculates the frequency according to the following equation:

$$\text{Frequency} = (\text{Setpoint} / 27648) \times 5 \text{ kHz}$$

You set the output value directly using your control program. The new frequency value is applied at the next rising edge of the output.

Output frequency accuracy

The configured output frequency is output with the following accuracy at the digital output DO:

- 0.01 Hz at output frequencies of 0.1 Hz to 800 Hz
- 0.1 Hz at output frequencies > 800 Hz to 2000 Hz
- 0.5 Hz at output frequencies > 2000 Hz to 5000 Hz

Set the on-delay when using the short control interface

You specify the on-delay as a value between 0 and 65535 in the parameters.

Configured on-delay = Time base x specified numerical value

When the short control interface is used, the factor for the on-delay can be used to adjust the configured time in your control program. Set the factor between 0 and 255, with a weighting of 0.1:

$$\text{On-delay} = \text{Factor} \times 0.1 \times \text{configured on-delay}$$

Isochronous mode

Generally applicable information is available in the section "Isochronous mode (Page 267)".

In the "Frequency output" operating mode, isochronous mode does not have any influence on the functionality.

Parameters of the "Frequency output" operating mode

Parameter	Meaning	Value range	Default
Operating mode	Set the "Frequency output" operating mode.	<ul style="list-style-type: none"> • Pulse output • Pulse-width modulation • Pulse train • On/Off-delay • Frequency output 	Pulse width modulation
Time base	Use the time base to select the resolution and the value range of the on-delay.	<ul style="list-style-type: none"> • 0.1 ms • 1 ms 	0.1 ms
Output format	Choose between 1 Hz and the S7 analog output format, depending on which output frequency resolution you need.	<ul style="list-style-type: none"> • 1 Hz • S7 analog output 	1 Hz
Function DI	You can use the digital input DI as an input or as a HW enable.	<ul style="list-style-type: none"> • Input • HW enable 	Input
On-delay ¹⁾	The time from the start of the output sequence to the output of the pulse train. You can change the on-delay in your control program using the "On-delay factor".	0 to 65535	0

¹⁾ Only if the short control interface is used
If the long control interface is used, enter this value directly in the control interface.

Control and feedback signals of the "Frequency output" operating mode

Control and feedback signals	Meaning	Value range	Channel 0 address	Channel 1 address
Control signals when the short control interface is used (8 bytes)				
Software enable (SW_ENABLE)	Starting and canceling of the output sequence.	0 = SW_ENABLE canceled 1 = SW_ENABLE set 0→1 = start of output sequence; may be dependent on the hardware enable	Byte 2: Bit 0	Byte 6: Bit 0
Output value	The value that is output in frequency format on the digital output DO.	Depending on the output format: <ul style="list-style-type: none"> • 1 Hz: 0 ... 5000 • S7 analog output: 0 to 27648 If you enter an output value > 5000 or 27648, the 2PULSE limits this to 5000 or 27648.	Word 0	Word 4
On-delay factor	The on-delay that has been assigned parameters can be changed before the start of the output sequence: On-delay = Factor x 0.1 x configured on-delay	0 to 255 If the on-delay < 0.2 ms or if factor = 0, the effective on-delay is = 0. If there is an on-delay > 65.535 s, the on-delay is limited to 65.535 s.	Byte 3	Byte 7
Control signals when the long control interface is used (12 bytes)				
Software enable (SW_ENABLE)	Starting and canceling of the output sequence.	0 = SW_ENABLE canceled 1 = SW_ENABLE set 0→1 = start of output sequence; may be dependent on the hardware enable	Byte 4: Bit 0	Byte 10: Bit 0
Output value	The value that is output in frequency format on the digital output DO.	Depending on the output format: <ul style="list-style-type: none"> • 1 Hz: 0 ... 5000 • S7 analog output: 0 to 27648 If you enter an output value > 5000 or 27648, the 2PULSE limits this to 5000 or 27648.	Word 0	Word 6
On-delay	The on-delay can be changed before the start of the output sequence.	0 to 65535 On-delay = Time basis x Specified numerical value	Word 2	Word 8

Control and feedback signals	Meaning	Value range	Channel 0 address	Channel 1 address
Feedback signals				
STS_ENABLE	Indicates an output sequence is running.	0 = pulse output blocked 1 = pulse output running	Byte 0: Bit 0	Byte 4: Bit 0
STS_DO	Indicates the signal level at the digital output DO. Note the update rate.	0 = Signal 0 on digital output DO 1 = Signal 1 on digital output DO	Byte 0: Bit 1	Byte 4: Bit 1
STS_DI	Indicates the signal level at digital input DI.	0 = Signal 0 on digital input DI 1 = Signal 1 on digital input DI	Byte 0: Bit 2	Byte 4: Bit 2
ACK_SW_ENABLE	Indicates the status of SW_ENABLE.	0 = SW_ENABLE cleared. 1 = SW_ENABLE set	Byte 0: Bit 3	Byte 4: Bit 3
SEQ_CNT	No function in this operating mode.	–	Byte 1: Bit 0 to 3	Byte 5: Bit 0 to 3
Measured value of the current	No function in this operating mode.	0	Word 2	Word 6

Input and output signals of the "Frequency output" operating mode

Input and Output Signals	Meaning	Value Range	Channel 0 terminal	Channel 1 terminal
Input signal				
HW enable	You can select the HW enable with the "Function DI" parameter. The signal of the digital input DI is then interpreted by the 2PULSE at the start of the output sequence.	0 = HW enable cleared 1 = HW enable issued 0 → 1 = Start of the output sequence; dependent on the software enable	1	5
Output signal				
Frequency on the digital output DO	The frequency is output on the digital output DO.	0 = no pulse 1 = pulse	4	8

5.4.7 Sequence counter

The 2PULSE has a sequence counter for each channel with which the completed output sequences are counted.

You can monitor the completion of an output sequence with the sequence counter SEC_CNT in the feedback interface.

The counter has a width of 4 bits. After an overflow it jumps back to 0.

Function of the sequence counter

The sequence counter has the following function in the individual operating modes:

- Pulse output and pulse train
 - Without hardware enable the counter is set to 1 after completion of the output sequence.
 - With hardware enable, the counter is incremented after every completed output sequence.
- On/Off-delay

The counter is incremented at DO with each edge (positive and negative).
- Pulse width modulation and frequency output

The counter does not have any function.

When the software enable (SW_ENABLE = 0) is created, the counter is reset to 0.

Application options

The sequence counter can be used in particular for:

- Detecting (counting) very short pulses
- Counting output sequences in connection with the hardware enable

5.4.8 Function: Measurement of current

The measurement of current can be set in a variety of applications for control and diagnostics purposes. You can read the measured value of the current from the feedback interface.

Principle of operation

A measurement of current only takes place during the pulse output in the "Pulse width modulation" and "Pulse train" operating modes. Without a pulse output (at STS_ENABLE = 0), 0 is supplied as the measured value. The measured value is valid at STS_ENABLE = 1.

In the "Pulse output", "On/Off-delay" and "Frequency output" operating modes, 0 is always measured as the measured value of the current.

The returned measured value of the current is a mean value of measured values that is recorded during the duration of a period. At period durations < 5 ms, the interval between two individual measuring points amounts to a maximum of 40 µs. When longer periods are involved, 128 measuring points per period are always recorded. This results in correspondingly longer intervals between the measuring points.

In isochronous mode, a new measured value of the current is always made available in the feedback interface at the moment T_i . In non-isochronous mode, a new measured value of the current is made available about every 500 µs.

Note

In order for the current measurement to work correctly, no freewheeling diode may be applied to the load.

Measuring range and measured value

The measuring range is set fixed to a rated current of 2 A.

The measured value of the current is supplied as a SIMATIC S7 analog value in the feedback interface.

- A current of 2 A corresponds to the SIMATIC S7 analog value of 27648.
- With a parallel connection, a current of 4 A corresponds to the SIMATIC S7 analog value of 27648.

Measurements of current are possible up to a SIMATIC S7 analog value of 32767. This corresponds to a current of 2.4 A. Currents exceeding 2 A may only occur briefly.

Accuracy

The accuracy of the measurement of current amounts to 3% of the measuring range.

Note

This accuracy during current measurement can only be achieved if the time period is not changed during the measurement.

5.4.9 Function: Direct Control of the DO Digital Output

Definition

You can directly control the digital output DO of the 2PULSE to test the actuator you have connected. To do this, you have to select the function from your control program with the MANUAL_DO control bit set and SW_ENABLE control bit cleared. The function

- Supports you in commissioning a plant
- Allows you to utilize an unused channel of the 2PULSE as DO

After you have selected the function, the feedback bits STS_ENABLE and ERR_PULS are cleared by the 2PULSE, and an active output sequence is aborted. The function takes precedence over the currently selected operating mode.

You specify the status of the digital output DO with the SET_DO control bit.

When you clear the MANUAL_DO control bit, you deselect the "Direct control of the digital output DO" function. This deletes the digital output DO. You can then restart an output sequence with the rising edge of SW_ENABLE.

Control and Feedback Signals/Output Signal

Signals	Meaning	Value range	When the short control interface is used (8 bytes)		When the long control interface is used (12 bytes)	
			Channel 0 address	Channel 1 address	Channel 0 address	Channel 1 address
Control signals						
SW_ENABLE	To select the function, the control bit must be deleted.	0 = SW_ENABLE cleared. 1 = SW_ENABLE set	Byte 2: Bit 0	Byte 6: Bit 0	Byte 4: Bit 0	Byte 10: Bit 0
MANUAL_DO	You can select and deselect the function with the control bit.	0 = direct control of the DO not selected. 1 = direct control of the DO selected.	Byte 2: Bit 1	Byte 6: Bit 1	Byte 4: Bit 1	Byte 10: Bit 1
SET_DO	You use the control bit to set the status of the digital output DO.	0 = signal 0 on digital output DO 1 = signal 1 on digital output DO	Byte 2: Bit 2	Byte 6: Bit 2	Byte 4: Bit 2	Byte 10: Bit 2
Feedback signals						
STS_ENABLE	Deleted after the function has been selected.	0 = pulse output blocked 1 = pulse output running	Byte 0: Bit 0	Byte 4: Bit 0	Byte 0: Bit 0	Byte 4: Bit 0
STS_DO	Indicates the signal level at the digital output DO. Note the update rate.	0 = Signal 0 on digital output DO 1 = Signal 1 on digital output DO	Byte 0: Bit 1	Byte 4: Bit 1	Byte 0: Bit 1	Byte 4: Bit 1
STS_DI	Indicates the signal level at digital input DI.	0 = Signal 0 on digital input DI 1 = Signal 1 on digital input DI	Byte 0: Bit 2	Byte 4: Bit 2	Byte 0: Bit 2	Byte 4: Bit 2

Signals	Meaning	Value range	When the short control interface is used (8 bytes)		When the long control interface is used (12 bytes)	
			Channel 0 address	Channel 1 address	Channel 0 address	Channel 1 address
Output Signal						
Digital output DO	The status preset with the SET_DO control bit is output on the digital output DO.	0 = No signal 1 = Signal	4	8	4	8

5.4.10 Function: Error Detection/Diagnostics

Parameter Assignment Error ERR_PARA

If the 2PULSE cannot identify the parameters as its own, it generates a parameter assignment error. The two channels are then not assigned parameters.

The 2PULSE slot you configure must match the setup.

Pulse output error ERR_PULS

The 2PULSE detects a channel-specific pulse output error in the pulse output, on/off-delay, and pulse train modes.

You can find information about causes and responses in the respective operating mode descriptions and in the section "Technical Specifications for Programming, Reference Lists (Page 353)".

The pulse output error detected is displayed for the relevant channel with the ERR_PULS feedback bit.

Short circuit of the encoder supply ERR_24V

The 2PULSE detects a short circuit in the encoder supply that it makes available at terminals 2 and 6.

The short circuit error detected is displayed for the two channels with the ERR_24V feedback bit.

A drop in the 24 V supply voltage can also result in a short circuit message.

Short circuit digital output ERR_DO

The 2PULSE detects a short circuit on the digital output of the channel.

The short circuit detected is displayed for the relevant channel with the ERR_DO feedback bit.

Note

If a short circuit occurs, the digital output is able to briefly supply a current substantially higher than the rated value.

Diagnostic Message

If a short circuit occurs in the encoder supply or in the digital output, the 2PULSE generates a diagnostic message for the connected CPU/master. You must enable the "Group diagnostics" parameter in this case.

Note

Diagnostic messages provide you the information that an error has occurred in one or both channels of the 2PULSE. You can evaluate the diagnostics with STEP 7.

The diagnostic record DS1 only contains the information for Channel 0. However, a diagnostic interrupt is also triggered at errors in Channel 1. The feedback signals provide detailed information about the occurring errors from both channels. Evaluate the feedback interface in new user programs (see below).

Parameters

Parameter	Meaning	Value Range	Default
Group diagnostics	When group diagnostics is enabled, the 2PULSE generates a diagnostic message for the CPU/master.	Disable/enable	Disable
Diagnostics DO	The 2PULSE detects a short circuit of the digital outputs when "Diagnostics DO" = On.	Off/on	On

Feedback Signals

Feedback Signals	Meaning	Value Range	Channel 0 address	Channel 1 address
ERR_PARA	Indicates a parameter assignment error.	0 = no parameter assignment error 1 = parameter assignment error	Byte 0: Bit 5	Byte 4: Bit 5
ERR_PULS	Indicates a pulse output error.	0 = no pulse output error 1 = pulse output error	Byte 0: Bit 4	Byte 4: Bit 4
ERR_24V	Indicates a short circuit of the encoder supply.	0 = no encoder supply short circuit 1 = encoder supply short circuit	Byte 0: Bit 7	Byte 4: Bit 7
ERR_DO	Indicates a short circuit of the digital output DO.	0 = no digital output short circuit 1 = digital output short circuit	Byte 0: Bit 6	Byte 4: Bit 6

5.4.11 Parallel connection of both channels

Definition

In order to achieve higher output current, you can connect both channels of the 2PULSE in parallel. You then obtain a rated current of 4 A. This allows you to also operate final controlling elements with a higher power requirement directly at the 2PULSE.

Parameter assignment and operation

You can enable parallel connection of the two channels during the configuration in HW Config by selecting the check box "Parallel connection Channel 0 and 1".

Once enabled, the 2PULSE operates like a single-channel module. All the parameter assignments and operations via the control interface have to be executed with Channel 0. Channel 1 cannot be configured and operated.

Feedback signals are also only provided for Channel 0.

Measurement of current

During the measurement of current, the measured values from both channels are averaged once more. This results in a measuring range up to 4 A.

The measured value of the current is supplied as a SIMATIC S7 analog value in the feedback interface. A current of 4 A corresponds here to the SIMATIC S7 analog value of 27648.

The accuracy of the current measurement also amounts to 3% of the measuring range in case of parallel connection.

Pin assignment for the parallel connection

The following terminals have to be connected at the terminal module for the parallel connection of both channels of the 2PULSE:

- Terminal 3 and Terminal 7
- Terminal 4 and Terminal 8

You then connect the load (e.g. a final controlling element) directly to Terminals 3 and 4 or to Terminals 7 and 8. The following figure shows a connection layout.

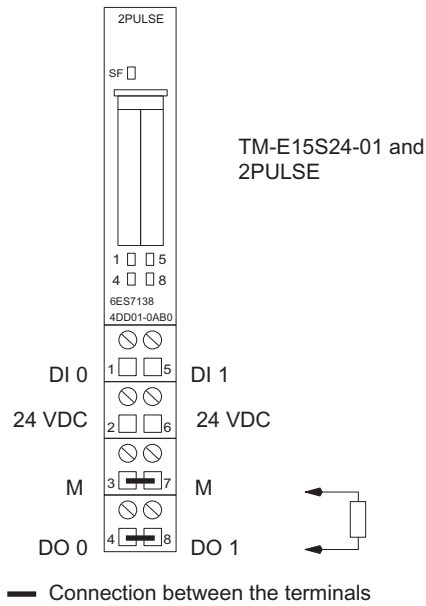

Figure 5-19 Parallel connection of both channels

5.4.12 Behavior at CPU-Master-STOP

Definition

You can configure the reaction of the 2PULSE to failure of the higher-level controller for the two channels together.

Response to CPU/master STOP	Channel-specific response and status of the 2PULSE
Turn off DO	Delete the DO digital output Delete STS_ENABLE and Terminate the current output sequence
Continue operating mode	The DO digital output remains unchanged STS_ENABLE remains unchanged and The current output sequence is continued
DO substitute a value	Output of the channel-specific, substitute value that has been assigned parameters of the DO digital output Delete STS_ENABLE and Terminate the current output sequence
DO keeps last value	The DO digital output remains unchanged Delete STS_ENABLE and Terminate the current output sequence

Startup

To start a new output sequence after CPU/master STOP and a set ACK_SW_ENABLE, first delete SW_ENABLE. Keep deleting until ACK_SW_ENABLE is also deleted.

If the mode is to continue during a change from CPU-/Master-STOP to RUN (startup), the CPU/Master cannot clear the outputs. **Possible solution:** In the part of the user program that is executed during startup, set the "Software enable" (SW_ENABLE = 1) control bit.

Modified Parameter Assignment

The status assumed by the 2PULSE at CPU/master STOP remains even in the case of parameter assignment or configuration of the ET 200S station. This occurs, for example, at POWER ON of the CPU/master or the IM 151 or at the resumption of DP transfer.

In "Continue working mode", however, and after loading changed parameters or configuration of the ET 200S station to the CPU/master, the 2PULSE terminates the process. As a result, the 2PULSE does the following:

- Deletes the DO digital output.
- Deletes STS_ENABLE and
- Terminates the current output sequence.

5.5 Parameter assignment and compatibility

5.5.1 Configuring the 2PULSE

Configuring with HW Config

There are 3 entries for configuring the 2PULSE in HW Config:

- 2PULSE (6ES7 138-4DD00-0AB0)
Select this entry if you want to operate the 2PULSE in compatibility mode (Page 320).
- 2PULSE (6ES7 138-4DD01-0AB0)
Using the short control interface
- 2PULSE ext. control interface (6ES7 138-4DD01-0AB0)
Using the long control interface

Select the control interface in accordance with your requirements:

- Short control interface: 8 bytes output data – compatible to predecessor module
The control interface uses fewer addresses in the process image.
- Long control interface: 12 bytes output data – improved controlling possibilities
You can enter the setpoints more conveniently.

All the parameters that you enter in HW Config are subjected to a plausibility check. If parameters are invalid, the ERR_PARA bit is set and the corresponding channel diagnostics provided.

Configuring with GSD file

The following rules have to be observed when configuring with a GSD file:

- In the "Pulse width modulation" operating mode:
 - With a time base of 0.1 ms, the values 0 and 1 are not permitted for the time period.
 - With a time base of 1 ms, the value 0 is not permitted for the time period.
 - Only values up to half of the time period are allowed for the minimum / pulse duration.
- In the "Pulse train" operating mode:
 - With a time base of 0.1 ms, the values 0 and 1 are not permitted for the time period.
 - With a time base of 1 ms, the value 0 is not permitted for the time period.
 - The value 0 is not permitted for the pulse duration (irrespective of the configured time base).
- In the "On/Off-delay" operating mode
 - The "Function DI" parameter may not be set to HW enable.
- With a parallel connection of both channels, all parameters of the second channel have to be set to 0.

- The "DO substitute value" parameter may only have a value not equal to 0 if the "Response to CPU/Master stop" parameter is set to "DO switch substitute value".
- Different channel-specific parameters are activated depending on the selected operating mode. The following table lists the active parameters for the individual operating modes. Parameters that are not listed must be set to 0.

Operating mode	Short control interface	Long control interface
Pulse output	Time base On-delay Function DI Diagnostics DO	Time base Function DI Diagnostics DO
Pulse width modulation	Time base On-delay Minimum / Pulse duration Time period Output format Function DI Diagnostics DO	Time base On-delay Minimum / Pulse duration Output format Function DI Diagnostics DO
Pulse train	Time base On-delay Minimum / Pulse duration Time period Function DI Diagnostics DO	Time base Function DI Diagnostics DO
On/Off-delay	Time base On-delay Diagnostics DO	Time base Diagnostics DO
Frequency output	Time base On-delay Output format Function DI Diagnostics DO	Time base Output format Function DI Diagnostics DO

5.5.2 Compatibility of the 2PULSE with predecessor versions

Compatibility mode

If you

- Have selected the entry 2PULSE (6ES7 138-4DD00-0AB0) when configuring in HW Config
- Have plugged the 2PULSE (6ES7 138-4DD01-0AB0) into a slot that is configured for the 2PULSE (6ES7 138-4DD00-0AB0)

The 2PULSE (6ES7 138-4DD01-0AB0) then operates in compatibility mode.

In compatibility mode, the 2PULSE has the functional differences listed in the table.

	2PULSE ...	
	Not in compatibility mode	In compatibility mode
Return of measured values of the current	Yes	No
Minimum pulse duration	100 μ s	200 μ s
"Frequency output" operating mode	Yes	No
Sequence counter for counting output sequences	Yes	No
Parallel connection of both channels	Yes	No
Isochronous mode	Yes	No

5.6 Diagnostics

5.6.1 Diagnostics using the LED display

LED display at the 2PULSE

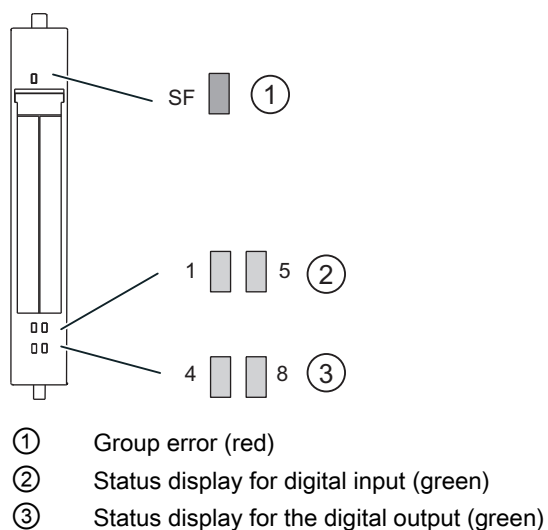

Status and error displays by means of LEDs on the 2PULSE

The table below shows the status and error displays on the 2PULSE.

Event (LEDs)	Cause				Remedy	
	SF	1	5	4		8
On					No parameter assignment. There is a diagnostic message.	Check the error bits types in the feedback interface. Evaluate the diagnostics data.
	On				Input DI0 on Channel 0 activated.	
		On			Input DI1 on Channel 1 activated.	
			On		Output DO0 on Channel 0 activated.	
				On	Output DO1 on Channel 1 activated.	

5.6.2 Error types

For information on the structure of the channel-related diagnostics, refer to the manual on the interface module used in your ET 200S station.

2PULSE error types

The following table shows the error types on the 2PULSE.

Error class		Meaning	Remedy
1 _D	00001: Short circuit	Short circuit of the sensor supply or the actuator. A drop in the 24 V supply voltage can also result in this error message.	Check the wiring to the switches and actuators. Correct the process wiring.
9 _D	01001: Error	Internal module error occurred.	Replace the module.
16 _D	10000: Parameter assignment error	Parameters have not been assigned to the module.	Correct the parameter assignment.

A simple error evaluation is also possible through the corresponding bits in the feedback interface (Page 353).

5.7 Application Examples

5.7.1 Overview

Introduction

The following application examples give you an overview of possible uses for the 2PULSE in different processes.

You use the 2PULSE in various modes according to your process-related requirements.

The table below presents the possible modes for selected technological processes:

Applications/Technological Processes	Mode
Filling of liquids	Pulse output
Heating a liquid	Pulse-width modulation
Packing piece goods	Pulse train
Applying a protective layer	On/Off-delay
Current regulation of a valve	Pulse width modulation

Due to the highly complex nature of these technological processes, each application example only represents part of a process.

This part illustrates the principle method of operation of the 2PULSE for the selected task. Assumed prerequisites allow you to evaluate how you can use the 2PULSE optimally in your process.

Additional Applications

Other possible uses are described in this section.

5.7.2 Example: Filling Liquids

Description

Filling is started as soon as a container is under the valve. The valve is opened for a preset pulse duration by means of the 24 V control signal. The amount of liquid is proportional to the specified pulse duration.

The 2PULSE generates the 24 V control signal at its digital output for the pulse duration you have specified. After it has been filled, the container is moved along.

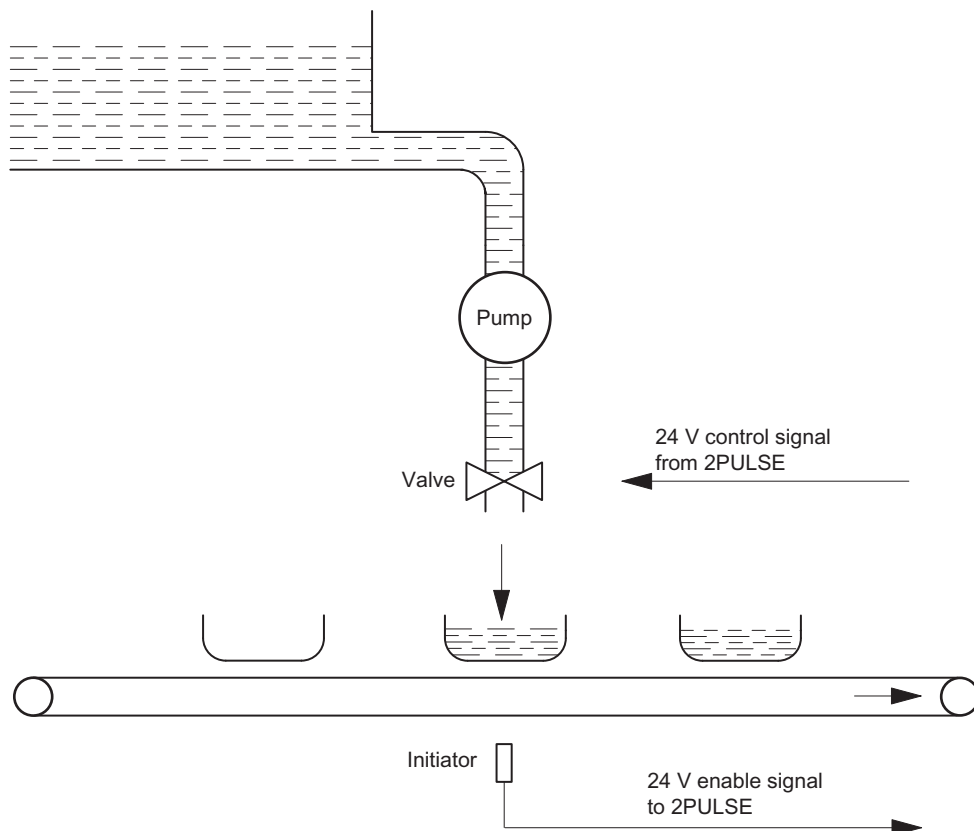

Figure 5-20 Filling of liquids

Requirements

- The volume of liquid to be filled is proportional to the time the valve is open.
- The cross-section of the feeder pipe cannot be changed.
- The valve only has the two positions OPEN and CLOSED.
- The minimum pulse duration must be longer than the on/off times specified by the manufacturer.

Pulse Output Mode

Use channel 0 of the 2PULSE in pulse output mode for the filling process. In this mode, the 2PULSE generates a pulse at the DO digital output (24 V control signal) for the specifiable pulse duration to control the valve.

Procedure

1. **Start of the filling process:** To start the process, use the software enable (SW_ENABLE) on your control program. The 2PULSE uses the 24 V enable signal (DI digital input) to check whether the container is correctly positioned. Then open the valve using the control program (SW_ENABLE 0→1) and start the filling process.
2. **Monitoring the filling process:** The error detection/diagnostic function allows you to check in the program that the process is running correctly.
3. **End of the filling process:** You can find out when the process has finished in the program by evaluating STS_ENABLE.

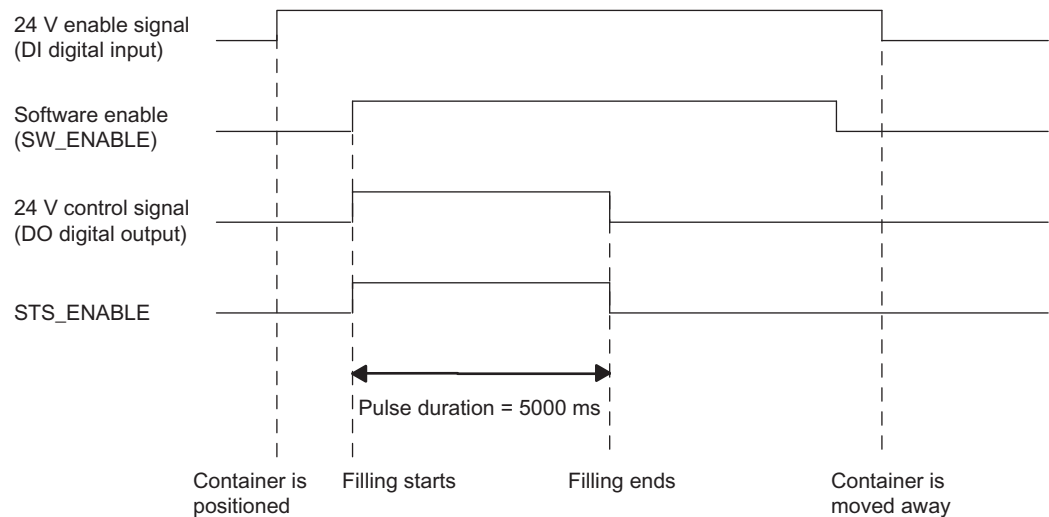

Figure 5-21 Flow Diagram for the Filling Process

Parameters

The following parameters are required for channel 0 of the 2PULSE to fill liquids in pulse output mode.

Table 5- 1 Parameter List for the Filling Process

Parameters	Set Value	Meaning
Group diagnosis	Enable	The following errors trigger a diagnostic message: <ul style="list-style-type: none"> • Short circuit digital output DO • Short circuit of the encoder supply
Diagnostics DO 0	On	The 2PULSE detects the short circuit error at the DO 0 digital output.
Response to CPU/master STOP	Turn off DO 0	
Mode	Pulse output	
Time base	1 ms	All the preset times are specified at a resolution of 1 ms.
DI function 0	Input	The digital input is used to establish whether the container is correctly positioned.
On-delay	0	The valve is opened immediately with SW_ENABLE = 1

The additional parameters of channel 0 of the 2PULSE have no effect on the pulse output mode.

The parameters for channel 1 are not relevant in this application example.

Programming/flow diagrams

Below you will find a section from a STEP 7 STL program.

The configured start address of the inputs and outputs of the 2PULSE is 256. Configured with a short control interface.

You use this part of the program to start the filling process. To do this, memory marker M30.0 must be set.

The pulse duration in this example is 5000 ms.

STL	Description
Block:	
L PEB256	Read the feedback messages from channel 0 of the 2PULSE
T MB20	
L 5000	Write a pulse duration of 5000 ms to channel 0 of the 2PULSE
T PAW256	
L 0	Generate SW_ENABLE
T MB10	
U M20.2	Container is positioned
U M30.0	Start of the filling process
= M10.0	Set SW_ENABLE=1
L MB10	Write control signals to channel 0 of the 2PULSE
T PAB258	

Wiring / Terminal Assignment Diagram

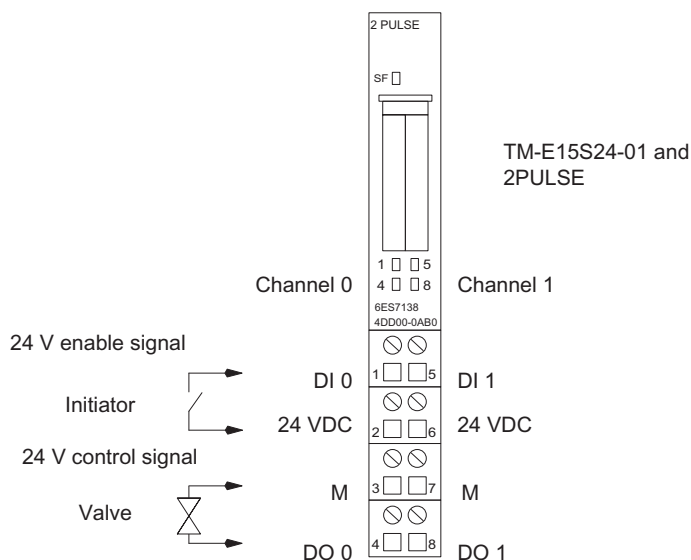

Figure 5-22 Terminal Assignment of the 2PULSE for Filling Liquids

5.7.3 Example: Heating a Liquid

Description

A liquid is heated with an electrical heating element. The energy needed to do this is supplied to the heating element by a switching element (a contactor, for example).

The 2PULSE generates a 24 V control signal on its digital output for the switching element. The temperature of the heating element is determined by the on/off length of the 24 V control signal.

The longer the 24 V control signal is switched on, the longer the heating process and therefore the greater the rise in temperature of the fluid.

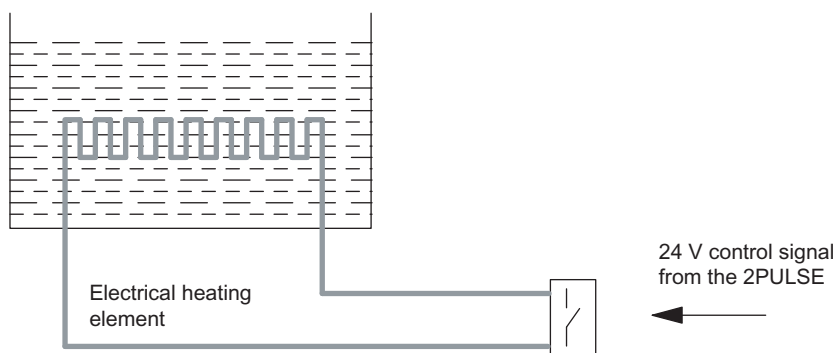

Figure 5-23 Heating a Liquid

Requirements

- The heating element only has two switching states: ON or OFF.
- The actual heating current corresponds to the ratio of the on/off duration of the 24 V control signal.
- The minimum pulse or minimum interpulse period must be greater than the response times of the switching element and heating element.

Pulse-Width Modulation (PWM) Mode

Use channel 0 of the 2PULSE in pulse-width modulation mode to control the heating element. In this mode, the 2PULSE generates a pulse train on the digital output DO (24 V control signal) with a specifiable ratio of pulse duration/period to control the switching element.

Sequence

1. **Starting heating process:** To start the heating process, use the software enable (SW_ENABLE) in your control program.

2. **Monitoring heating process:** The error detection/diagnostic function allows you to check via the program that the heating element is being controlled correctly.

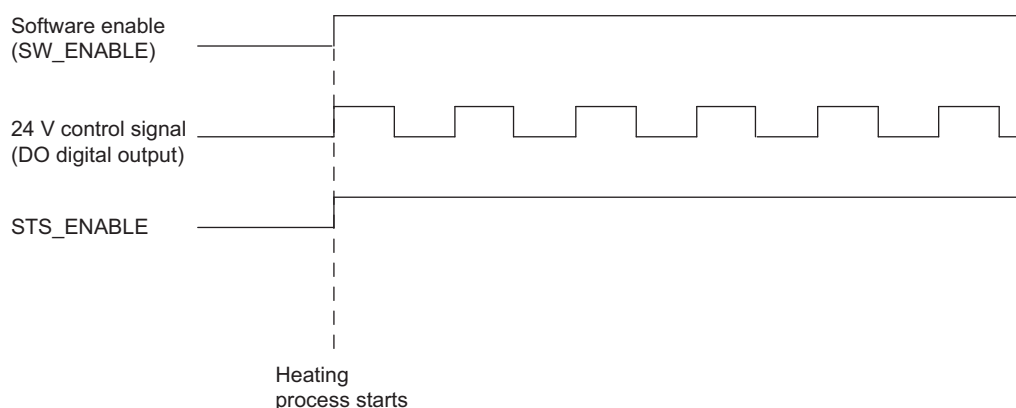

Figure 5-24 Flow Diagram for Heating a Liquid

Parameters

The following parameters are required for channel 0 of the 2PULSE to heat a liquid in pulse-width modulation mode.

Table 5-2 Parameter List for Heating a Liquid

Parameter	Set Value	Meaning
Group diagnostics	Enable	The following errors trigger a diagnostic message: <ul style="list-style-type: none"> • Short circuit digital output • Short circuit of the encoder supply
Diagnostics DO 0	On	The 2PULSE detects the short circuit error on the digital output DO 0.
Response to CPU/master STOP	Turn off DO 0	
Mode	Pulse-width modulation	
Output format	Per mill	The output value is specified in Per mill (0 to 1000)
Time base	1 ms	All the preset times are specified at a resolution of 1 ms.
Function DI 0	Input	The digital input is not required for this application
On-delay	0	The 24 V control signal is immediately output with SW_ENABLE=1
Minimum pulse duration	500	Minimum pulse duration: This is 500 ms in the selected time base; this also applies to the minimum interpulse period
Period	30000	This is 30 s in the selected time base

The parameters for channel 1 are not relevant in this application example.

Programming/Flow Diagram

Below you will find a section from a STEP 7 STL program.

The configured start address of the inputs and outputs of the 2PULSE is 256. Configured with a short control interface.

This program section starts the heating process. To do this, memory bit M30.0 must be set. You provide the output value in memory word MW32.

STL	Description	
Block:		
L	PEB256	Read the feedback messages from Channel 0 of the 2PULSE
T	MB20	
L	MW32	Write output value to channel 0 of the 2PULSE
T	PAW256	
L	10	Write period factor 10 x 0.1 to channel 0 of the 2PULSE
T	PAB259	
L	0	Generate control signal SW_ENABLE
T	MB10	
U	M30.0	Start of heating process
=	M10.0	Set SW_ENABLE=1
L	MB10	Write control signals to Channel 0 of the 2PULSE
T	PAB258	

Wiring / Terminal Assignment Diagram

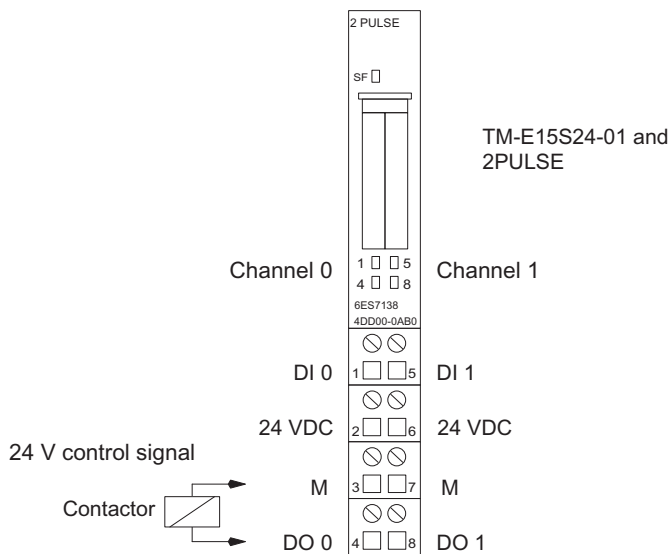

Figure 5-25 Terminal Assignment of the 2PULSE for the Heating of a Liquid

Additional Applications

Limit-value monitoring of the temperature: To monitor the limits of the temperature of the medium, use a temperature sensor evaluated by an analog module. You can monitor the temperature with your control program.

Temperature control: To control the temperature of the medium, use a temperature sensor evaluated by an analog module. You can use one of the software controllers of SIMATIC S7 to do this. Pass on the manipulated variable calculated by the software closed-loop controller directly to the 2PULSE using your control program. If you require separate actuators for heating and cooling, use the second channel of the 2PULSE. If you detect a negative manipulated variable in your control program, pass on the value to the second channel of the 2PULSE.

Heating up a liquid with a heat exchanger: Basic actuators that only have two end settings (OPEN/CLOSED) create an almost continuous manipulated variable through the control of the 24 V control signal. This will enable you to control, for example, the flow through a heat exchanger using a solenoid valve.

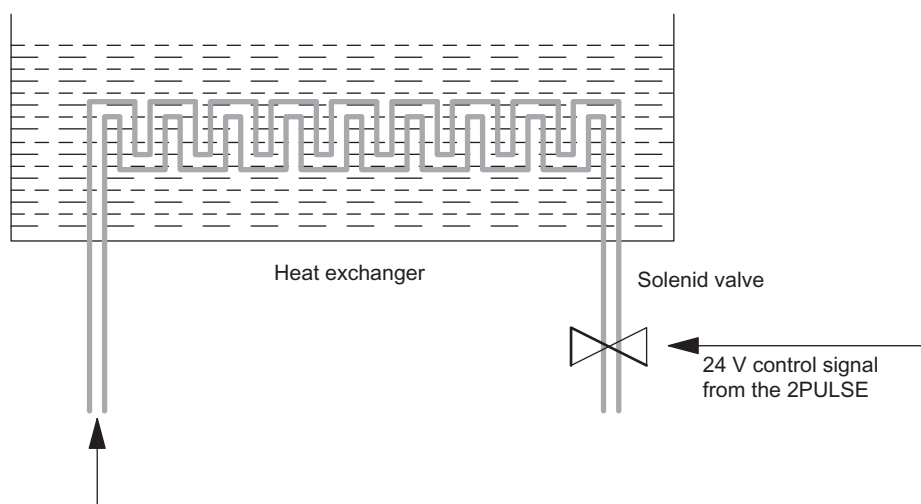

Figure 5-26 Using a Solenoid Valve to Control the Flow

5.7.4 Example: Packing Piece Goods

Description

Packing is started as soon as a folding box from conveyor 1 is in the correct position. The 24 V control signal controls the pusher and, when the compartmentalized conveyor is in operation, pushes the piece goods into the folding box. Each pulse corresponds to a complete movement of the pusher. The next movement of the pusher begins at the next pulse from the pulse train.

The number of items that have to be packed corresponds to the number of output pulses.

The 2PULSE generates the 24 V control signal on its digital output DO with the number of pulses you have specified. After the piece goods have been packed, the folding box is moved on.

Counting begins from the start again when a new folding box passes the initiator.

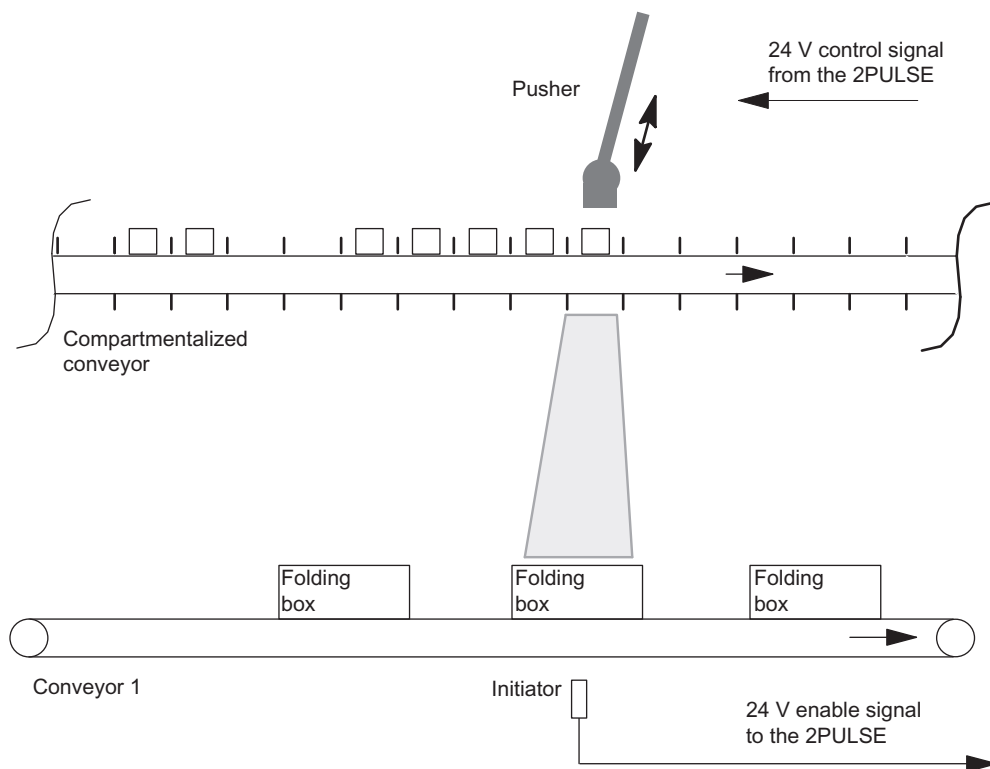

Figure 5-27 Packing Piece Goods

Requirements

- Identical piece goods
- Repetition rate depends on the conveyor behavior
- Constant speed of the compartmentalized conveyor during pulse output
- The pulse duration and interpulse period must be longer than the response time of the pusher.

Pulse Train Mode

Use channel 0 of the 2PULSE in pulse train mode to pack piece goods. In this mode, the 2PULSE generates a specifiable number of pulses on the digital output DO to control the pusher. The pulse duration and period of the output signal can be adjusted.

Sequence

1. **Starting the packing process:** To enable the start, use the software enable (SW_ENABLE 0→1) in your control program. The 2PULSE uses the 24 V enable signal (HW enable, digital input DI) to tell whether the folding box is correctly positioned and then starts the pusher.
2. **Monitoring the packing process:** The error detection/diagnostic function allows you to check via the program that the packing process is running correctly.
3. **End of the packing process:** By evaluating STS_ENABLE, you can find out when the preset number of goods has been packed.

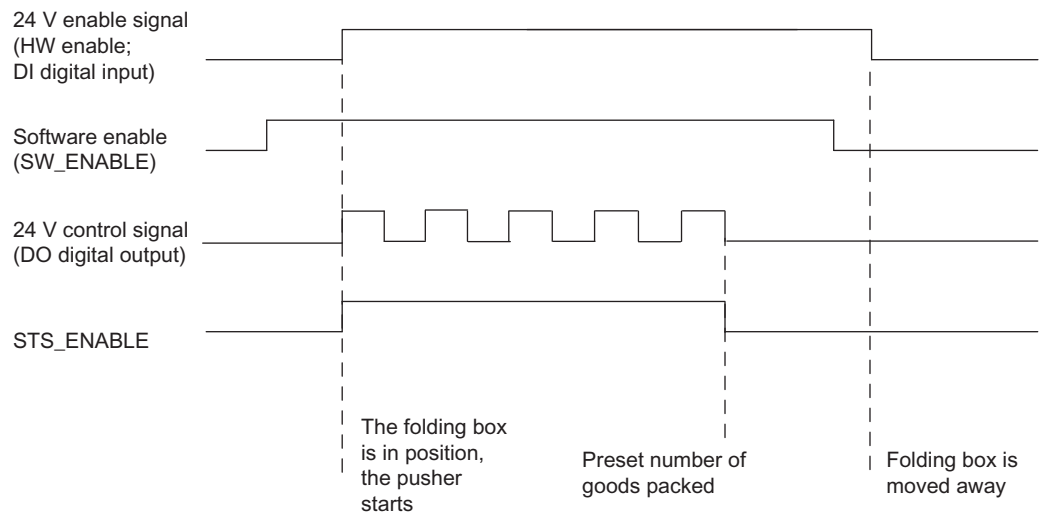

Figure 5-28 Flow Diagram for the Packing of Piece Goods

Parameters

The following parameters are required for channel 0 of the 2PULSE to pack piece goods in pulse train mode.

Table 5- 3 Parameter List for the Packing of Piece Goods

Parameter	Set Value	Meaning
Group diagnostics	Enable	The following errors trigger a diagnostic message: <ul style="list-style-type: none"> • Short circuit digital output • Short circuit of the encoder supply
Diagnostics DO 0	On	The 2PULSE detects the short circuit error on the digital output DO 0.
Response to CPU/master STOP	Turn off DO 0	
Operating mode	Pulse train	
Time base	1 ms	All the preset times are specified at a resolution of 1 ms.
Function DI 0	HW enable	
On-delay	0	The pusher is controlled immediately with the software enable.
Minimum pulse duration	500	This is 500 ms in the selected time base
Period	1000	This is 1 s in the selected time base. This results in an interpulse period of 500 ms.

The parameters for Channel 1 are not relevant in this application example.

Programming/Flow Diagram

Below you will find a section from a STEP 7 STL program.

The configured start address of the inputs and outputs of the 2PULSE is 256. Configured with a short control interface.

You can use this program section to start the packing process (5 pieces). To do this, memory bit M30.0 must be set.

The HW enable then starts the pulse train.

STL	Description
Block	
L PEB256	Read the feedback messages from Channel 0 of the 2PULSE
T MB20	
L 5	Write the number of pieces (5) to channel 0 of the 2PULSE
T PAW256	
L 10	Write period factor 10 x 0.1 to Channel 0 of the 2PULSE
T PAB259	
L 0	Generate control signal SW_ENABLE
T MB10	Enable the packing process
U M30.0	
= M10.0	Set SW_ENABLE=1
L MB10	Write control signals to Channel 0 of the 2PULSE
T PAB258	

5.7.5 Example: Applying a Protective Layer

Description

Metal parts are to be covered with a wax layer. The conveyor belt moves at a constant speed. As soon as a metal part passes the initiator, the valve is opened. The distance the item and the wax have to cover is proportional to the time.

The 2PULSE receives a 24 V enable signal from the initiator. The 2PULSE then generates a 24 V control signal at its digital output that opens the valve. The valve remains open while the Initiator sends the 24 V enable signal to the 2PULSE.

To ensure that the wax hits the metal at the optimum time, a corresponding on/off-delay is required.

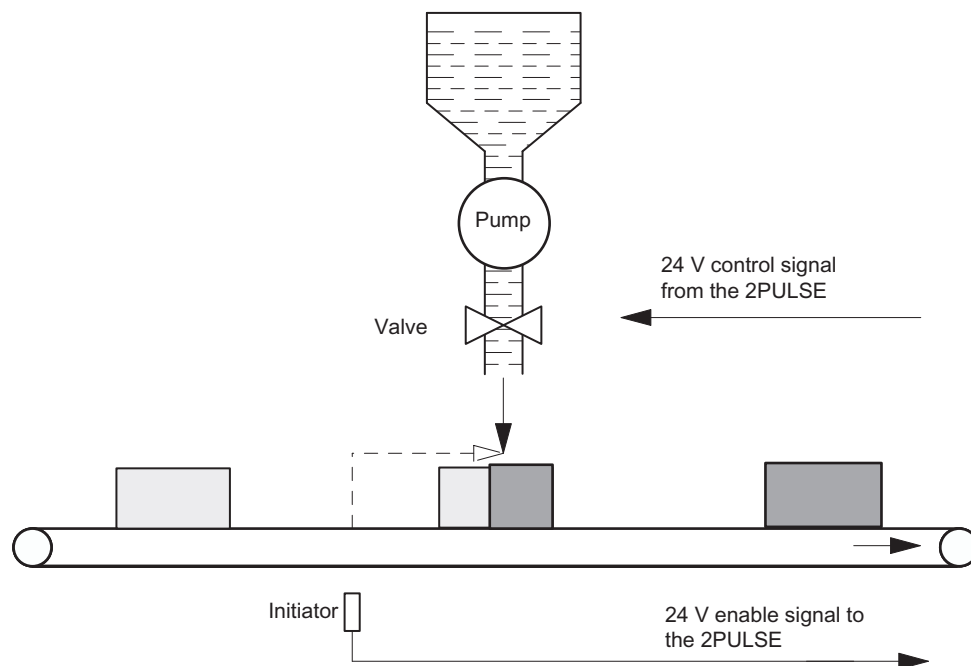

Figure 5-30 Applying a protective layer

Requirements

- The item is moved at a constant and quantifiable speed. (The distance is proportional to the time.)
- The valve only has the two positions OPEN and CLOSED.
- The minimum pulse duration must be longer than the on/off times specified by the manufacturer.

On/Off-Delay Mode

Use channel 0 of the 2PULSE in on/off-delay mode to control the valve. In this mode, the 2PULSE generates a 24 V control signal at its DO digital output to control the valve. This 24 V control signal is switched on and off with the 24 V enable signal.

Sequence

1. **Starting the procedure:** To start the process, use the software enable (SW_ENABLE) on your control program. The 2PULSE uses the 24 V enable signal (DI digital input) to check whether a metal object is positioned at the initiator. The valve is opened on expiration of the on-delay. If the metal object goes past the initiator, the valve is closed after the off-delay has expired.
2. **Monitoring the procedure:** The error detection/diagnostic function allows you to check by means of a program that the valve is being controlled correctly.
3. **End of the procedure:** You can tell on the program by evaluating the STS_DO (status of the 24 V control signal) when the process has ended.

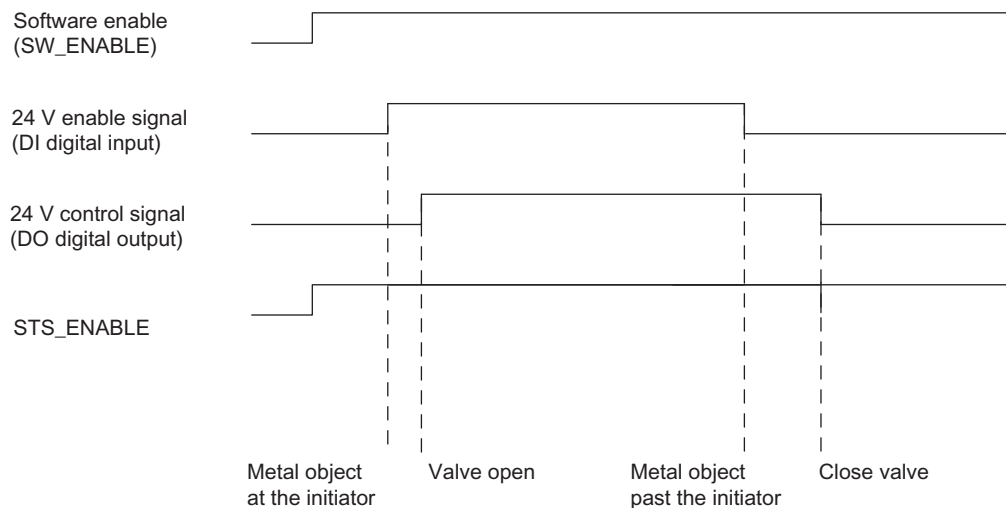

Figure 5-31 Flow Diagram for Applying a Protective Layer

Parameters

The following parameters are required for channel 0 of the 2PULSE to apply a protective layer in on/off-delay mode.

Table 5- 4 Parameter List for Applying a Protective Layer

Parameters	Set Value	Meaning
Group diagnosis	Enable	The following errors trigger a diagnostic message: <ul style="list-style-type: none"> • Short circuit digital output • Short circuit of the encoder supply
Diagnostics DO 0	On	The 2PULSE detects the short circuit error at the DO 0 digital output.
Response to CPU/master STOP	Turn off DO	
Operating mode	On/Off-delay	
Time base	1 ms	All the preset times are specified at a resolution of 1 ms.
On-delay	500	The valve is switched on after an on-delay of 500 ms.

The additional parameters of Channel 0 of the 2PULSE have no effect on on/off-delay mode.

The parameters for channel 1 are not relevant in this application example.

Programming/Flow Diagram

Below you will find a section from a STEP7 STL program.

The configured start address of the inputs and outputs of the 2PULSE is 256. Configured with a short control interface.

You use this part of the program to start the process. To do this, memory marker M30.0 must be set. Set up the off-delay in memory word MW32.

STL	Description
Block:	
L PEB256	Read the feedback messages from channel 0 of the 2PULSE
T MB20	
L MW32	Write off-delay to channel 0 of the 2PULSE
T PAW256	
L 10	Write on-delay factor 10 x 0.1 to channel 0 of the 2PULSE
T PAB259	
L 0	Generate SW_ENABLE control signal
T MB10	
U M30.0	Heating process starts
= M10.0	Set SW_ENABLE=1
L MB10	Write control signals to channel 0 of the 2PULSE
T PAB258	

Wiring / Terminal Assignment Diagram

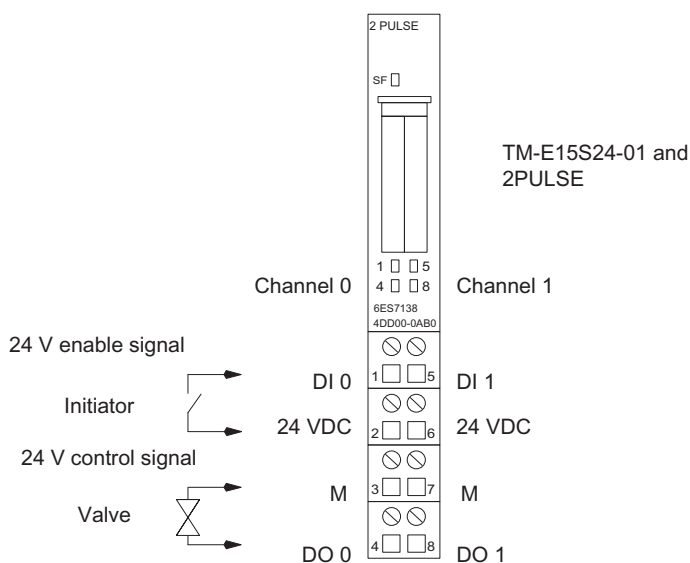

Figure 5-32 Terminal Assignment of the 2PULSE for Applying a Protective Layer

5.7.6 Current regulation of a valve

Preliminary remark

In order to successfully design a control loop for current regulation of a valve, corresponding knowledge of control technology and the concrete control task is required.

Description

A proportional valve is used to control the pressure in a vessel. In order to compensate for thermal effects in the valve, it is addressed with a controlled current. Together with the higher-level control loop (pressure control), a cascade control system results in which the current regulation of the valve forms the inner component. The structure of the higher-level pressure control is not addressed in this example.

The valve is controlled directly through the 24 V control signal of the 2PULSE. Pulse width modulation is selected as the operating mode. The execution of the current measurement required for the control is integrated in the 2PULSE.

For the higher-level pressure control, an analog input module detects the data from a pressure sensor mounted correspondingly. The pressure measured values determined are input to the pressure regulator that runs on the CPU.

In order to achieve particularly high-performance control, 2PULSE can also be operated in isochronous mode (see section "Isochronous mode (Page 267)").

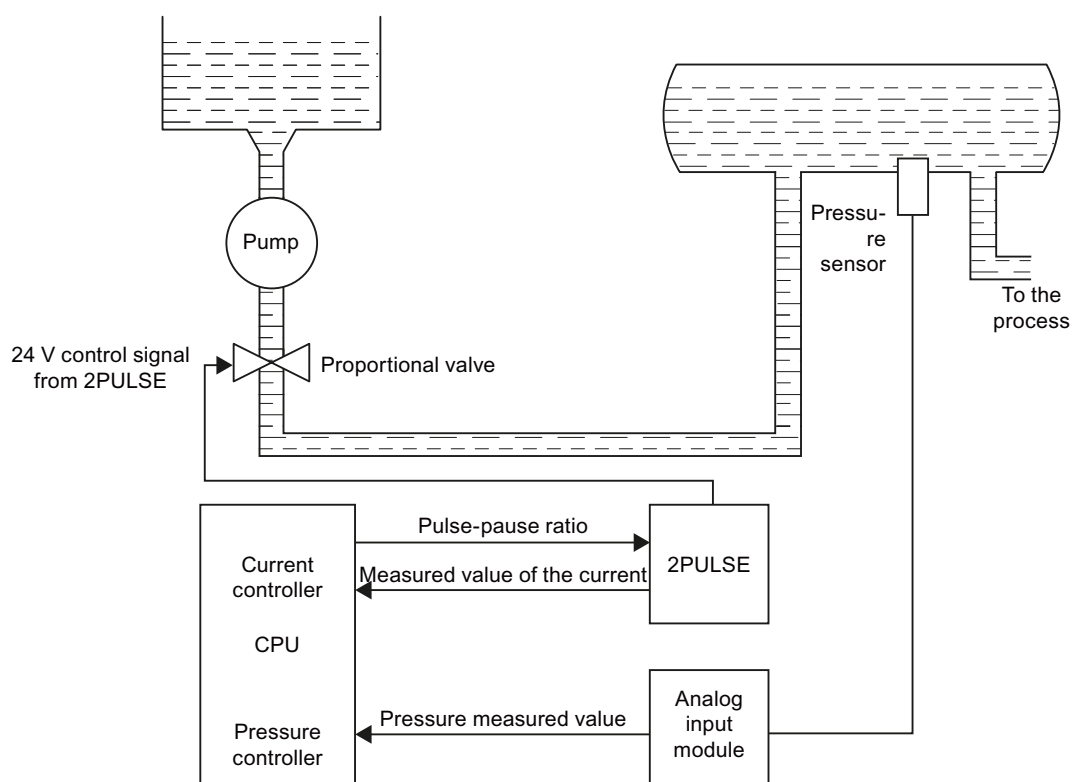

Figure 5-33 Application example with current-controlled valve

Requirements

- A valve suitable for controlling (proportional valve)
- Suitable electric data of the valve (24 V, max. 2 A or 4 A with parallel connection of both channels of the 2PULSE)
- When designing the control loop, take the additional data of the valve into consideration, in particular the time constant of the contained inductance and the manufacturer's recommendation regarding the time period of the PWM signal.

Time period and control cycle

- Select a time period less than or equal to the cycle time of the controller. For optimal control quality, determine the cycle time of the controller on the basis of the time constant of the inductance.
- Do not change the time period during operation.

Parameters

The following parameters are required for Channel 0 of the 2PULSE for the current regulation of a valve with the "Pulse width modulation" operating mode.

Table 5- 5 Parameter list for current regulation of a valve

Parameter	Set value	Meaning
Group diagnostics	Enable	The following errors trigger a diagnostic message: <ul style="list-style-type: none"> • Short circuit digital output • Short circuit of the encoder supply
Diagnostics DO 0	On	The 2PULSE detects the short circuit error on the digital output DO 0.
Response to CPU/master STOP	Turn off DO 0	
Operating mode	Pulse width modulation	
Output format	S7 analog output	This means that the corresponding output of the controller can be used without further conversion.
Time base	0.1 ms	
Function DI 0	Input	The digital input is not required for this application.
On-delay	0	The on-delay is not required for this application.
Minimum pulse duration	0	A minimum pulse duration has a negative affect on control. ¹⁾
Time period	50	In this example, 5 ms are set for the time period of the PWM signal. ¹⁾

¹⁾ When setting this parameter, take the recommendations of the valve manufacturer into consideration.

The parameters for Channel 1 are not relevant in this application example.

Programming/flow diagrams

Below you will find a section from a STEP 7 STL program.

Take the following points into consideration:

- The configured start address of the inputs and outputs of the 2PULSE is 256. Configured with a short control interface.
- The standard block FB 41 with DB 1 as the instance data block is used as the controller. The differential component of the controller is deactivated. The block is therefore only used as a PI controller. The FB 41 "CONT_C" is contained in the "Standard Library" supplied with STEP 7 in the "PID Control Blocks" directory. Detailed information about FB 41 is available in the System and Standard Functions (<http://support.automation.siemens.com/WW/view/en/1214574>) reference manual.
- The following example program does not provide for an explicit enable. The controller starts operating immediately after the CPU start.

NOTICE
Therefore, take the required safety precautionary measures for your real system.

5.7 Application Examples

First, you have to initialize the controller at a restart with the following STL program in OB 100. Adapt the parameters of the FB 41 as required. The program furthermore sets the factor for the time period to "10" (meaning that the active factor is 1.0) and sets the SW_ENABLE bit to "1". This is used by the 2PULSE to start operation.

STL		Description
CALL	FB41,DB1	Reset controller block
	COM_RST :=TRUE	
	MAN_ON :=FALSE	
	PVPER_ON :=TRUE	
	P_SEL :=TRUE	
	I_SEL :=TRUE	
	INT_HOLD :=FALSE	
	I_ITL_ON :=FALSE	
	D_SEL :=FALSE	
	CYCLE :=T#5MS	
	SP_INT :=0.000000e+000	
	PV_IN :=	
	PV_PER :=	
	MAN :=	
	GAIN :=2.000000e+000	
	TI :=T#10MS	
	TD :=	
	TM_LAG :=	
	DEADB_W :=	
	LMN_HLM :=1.000000e+002	
	LMN_LLM :=0.000000e+000	
	PV_FAC :=1.000000e+000	
	PV_OFF :=0.000000e+000	
	LMN_FAC :=1.000000e+000	
	LMN_OFF :=0.000000e+000	
	I_ITLVAL :=0.000000e+000	
	DISV :=	
	LMN :=	
	LMN_PER :=	
	QLMN_HLM :=	
	QLMN_LLM :=	
	LMN_P :=	
	LMN_I :=	
	LMN_D :=	
	PV :=	
	ER :=	
L	10	Set the factor for the time period to 10
T	PAB 259	
L	1	Set SW_ENABLE to 1
T	PAB 258	

Afterwards, you have to call the control block cyclically in a cyclic interrupt OB (OB 30 to OB 38). The cycle time of the cyclic interrupt OB has to be made known to the FB 41 using the parameter CYCLE, in the above example 5 ms. When the controller is called, the measured value of the current and the PWM setpoint of the 2PULSE are interconnected directly with the controller. Other cyclic calls are not necessary.

STL	Description
CALL FB41,DB1	
COM_RST	:=FALSE
MAN_ON	:=
PVPER_ON	:=
P_SEL	:=
I_SEL	:=
INT_HOLD	:=
I_ITL_ON	:=
D_SEL	:=
CYCLE	:=
SP_INT	:=
PV_IN	:=
PV_PER	:=PEW258
MAN	:=
GAIN	:=
TI	:=
TD	:=
TM_LAG	:=
DEADB_W	:=
LMN_HLM	:=
LMN_LLM	:=
PV_FAC	:=
PV_OFF	:=
LMN_FAC	:=
LMN_OFF	:=
I_ITLVAL	:=
DISV	:=
LMN	:=
LMN_PER	:=PAW256
QLMN_HLM	:=
QLMN_LLM	:=
LMN_P	:=
LMN_I	:=
LMN_D	:=
PV	:=
ER	:=

Monitoring and setting the control

With a variable table, you can monitor or set all the important parameters of the control. If, for example, you change the DB1.SP_INT setpoint, you see how the measured value of the current in DB1.PV responds. Note that certain values of the DB 1 are already assigned when called in OB 100.

The following table shows an example of a variable table.

Address	Display format	Description
DB1.SP_INT	FLOATING POINT	Setpoint of the current (0.0 to 100.0)
DB1.PV	FLOATING POINT	Controller-internal representation of the measured value of the current (0.0 to 100.0)
DB1.GAIN	FLOATING POINT	Proportional gain of the controller
DB1.TI	FLOATING POINT	Integration time of the controller

Additional optimization possibilities

- Depending on the concrete implementation, the master control behavior of the current regulator can be improved by a precontrol. In the simplest case the setpoint of the current multiplied by a constant factor can be added to the controller output.
- Depending on the application, manual operation or controlled starting and stopping of the control is required. The corresponding integrated functions of the FB 41 can be used to this purpose.
- The data transfer at the fieldbus causes dead times. In isochronous mode, you can achieve a state in which these dead times are constant. This makes a more aggressive setting of the controller parameters possible, thus improving the control quality.

Wiring / Terminal Assignment Diagram

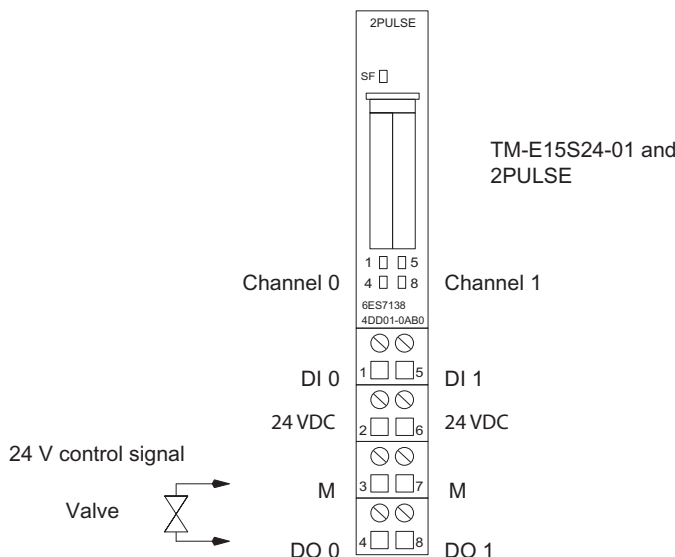

Figure 5-34 Terminal assignment of the 2PULSE for the current regulation of a valve

5.8 Technical Specifications of the 2PULSE, Terminal Assignment

Overview

General technical specifications	
Dimensions and Weight	
Dimensions W x H x D (mm)	15 x 81 x 52
Weight	Approx. 40 g
Data for Specific Modules	
Number of Channels	2
Voltages, Currents, Potentials	
Rated load voltage L+ (from the power module)	24 VDC
• Reverse polarity protection	Yes ¹⁾
Galvanic isolation	
• Between the channels	No
• Between the channels and backplane bus	Yes
Permissible potential difference	
• Between different circuits	75 VDC, 60 VAC
Insulation tested with	500 VDC
Encoder supply	
• Output voltage	L+ -0.8 V
• Output current	Max. 500 mA (Total current at terminals 2 and 6), short circuit proof
Current consumption	
• From the backplane bus	max. 10 mA
• From load voltage L+ (no load)	Approx. 30 mA
Power loss of the 2PULSE	Typ. 1.8 W
Data for the Digital Inputs	
Input voltage	
• Rated value	24 VDC
• For signal "1"	11 V to 30 V
• For signal "0"	-30 V to 5 V
Input current	
• with "1" signal	10 mA (typically)
Minimum pulse duration/interpulse period	25 µs
Maximum response time	100 µs
Input characteristic	In accordance with IEC 1131, Part 2, Type 2
Connection of 2-wire BEROs	Possible
• Permitted residual current	≤ 2 mA
Shielded cable length	Max. 100 m

General technical specifications	
Data for the Digital Outputs	
Output voltage • with "1" signal	Minimum L+ - 1 V
Output current • with "1" signal – Rated value – Permitted Range • With "0" signal (residual current)	2 A ²⁾ (4 A at parallel connection) 7 mA...2 A max. 0.1 mA
Measurement of current • Accuracy	Yes, in the "Pulse width modulation" and "Pulse train" operating modes 3 %
Minimum pulse duration • In compatibility mode	100 µs 200 µs
Accuracy	± (period duration x 100 ppm) ±100 µs ³⁾
Output delay (with resistive load) • At "1" to "0" transitions • At "1" to "0" transitions	max. 100 µs max. 200 µs
Lamp load	Maximum 10 W
Control of a digital input	Yes
Switching frequency ⁴⁾	Up to 5 kHz Take the technical specifications of your connected load into consideration.
Limitation (internal) of the inductive circuit interruption voltage	L+ -(50 V ... 65 V)
Short circuit protection for output • Response threshold	Yes Typ. 10 A to 16 A
Cable lengths • Unshielded • Shielded	600 m 1000 m
Status, Interrupts, Diagnostics	
Status indicators	Green LED for DI 0, DI 1, DO 0, DO 1
Diagnostic functions • Group error • Diagnostic information readable	Red LED "SF" Yes
<p>¹⁾ Polarity reversal can lead to the digital outputs being switched through.</p> <p>²⁾ See the figures below</p> <p>³⁾ With a load of ≤ 50 Ω</p> <p>⁴⁾ Asymmetrical edge slopes appear to be a higher percentage when switching the outputs on and off at higher frequencies</p>	

The figures below show you the maximum permissible output current in relation to the ambient temperature and the frequency.

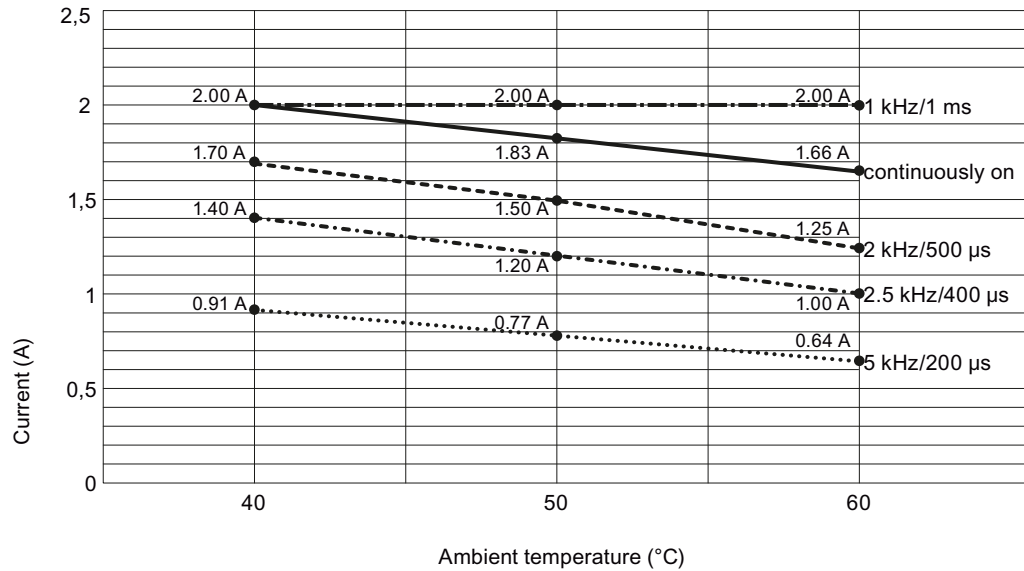

Figure 5-35 Resistive Load - both channels independent, PWM 50/50

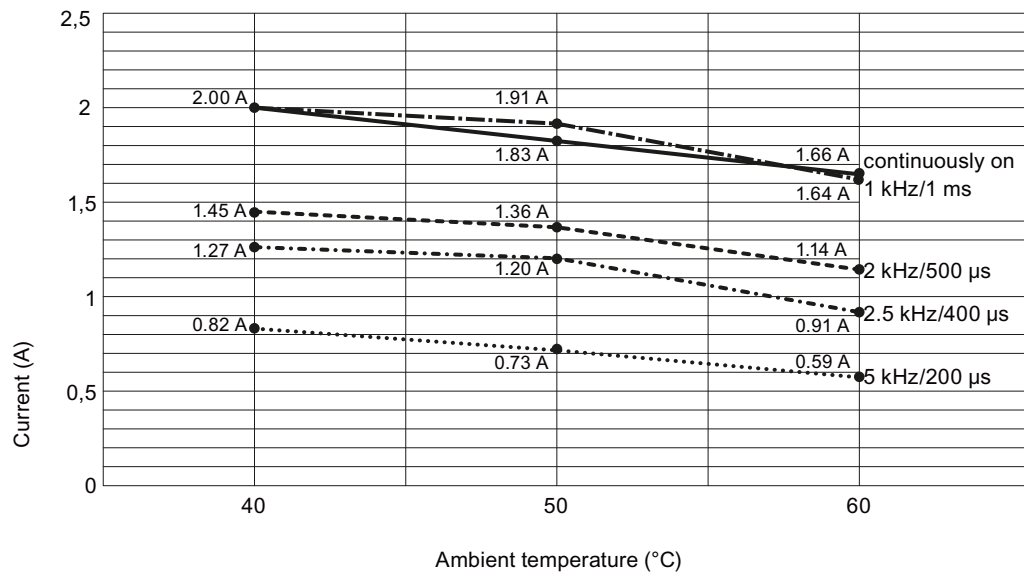

Figure 5-36 Resistive Load - both channels independent, PWM 90/10

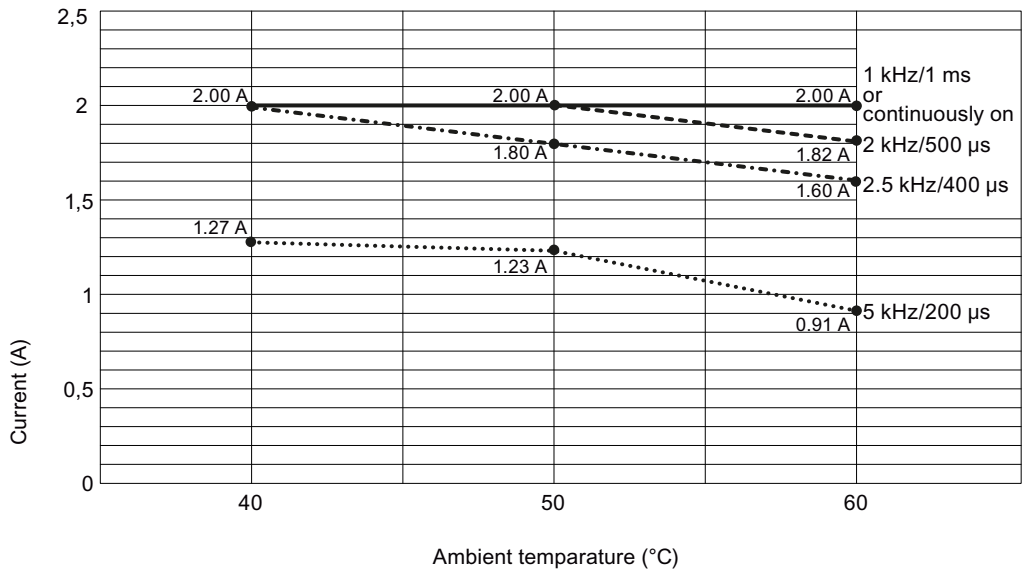

Figure 5-37 Resistive Load – only one channel, PWM 50/50

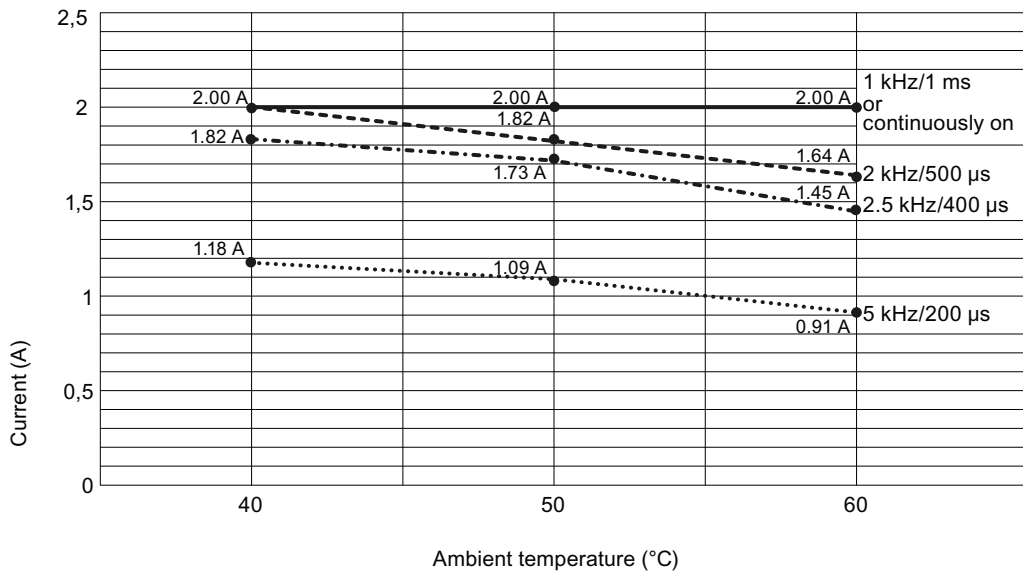

Figure 5-38 Resistive Load – only one channel, PWM 90/10

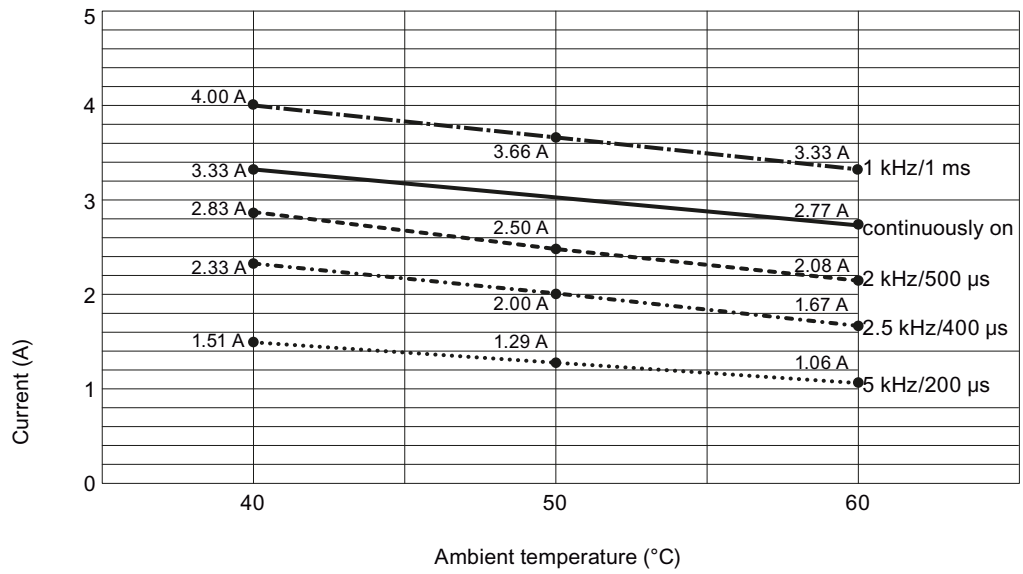

Figure 5-39 Resistive Load – both channels in parallel, PWM 50/50

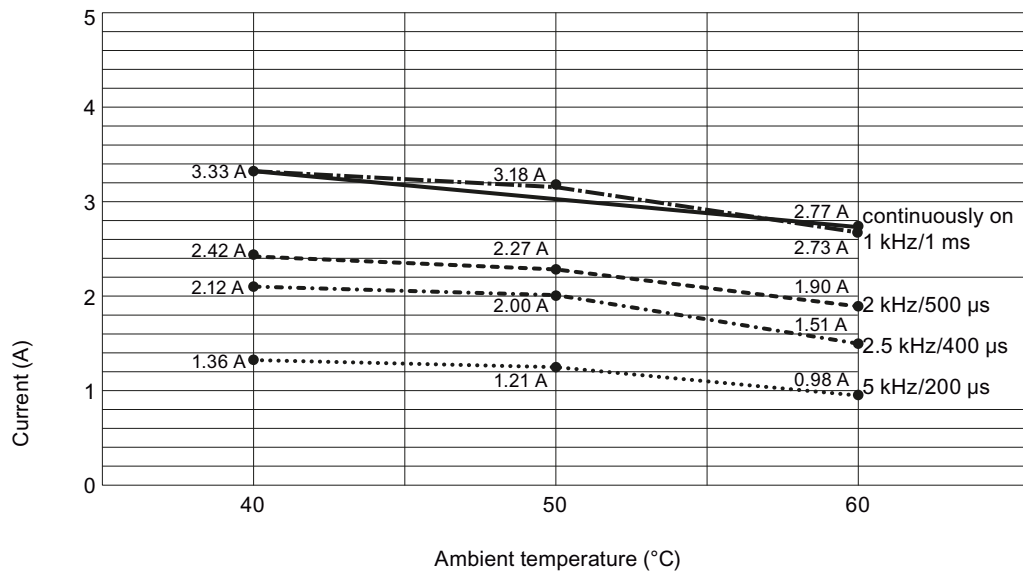
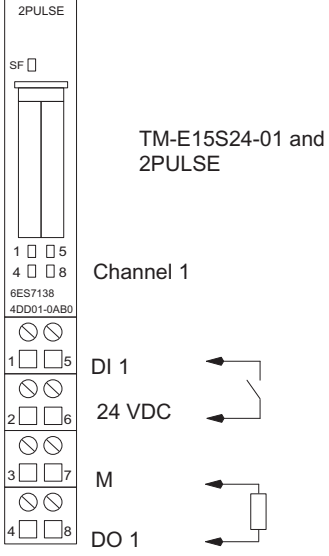

Figure 5-40 Resistive Load – both channels in parallel, PWM 90/10

Terminal Assignment

The following figure shows the terminal assignment for the 2PULSE.

View	Terminal Assignment	Meaning
		<p>Channel 0: Terminal 1 to 4 Channel 1: Terminal 5 to 8 24 VDC: Encoder supply M: Chassis ground DI: Input Signal DO: Output Signal (Maximum 2 A per channel)</p>

Wiring Rules

The cables (terminals 1 and 2 and terminals 5 and 6) must be shielded. The shield must be supported at both ends. To do this, use the shield contact (see the appendix of the ET 200S Distributed I/O System (<http://support.automation.siemens.com/WW/view/en/1144348>) operating instructions).

5.9 Technical Specifications for Programming, Reference Lists

Assignment of the short control interface (8 bytes)

Address		Assignment
Channel 0	Channel 1	
Word 0	Word 4	Depending on the mode <ul style="list-style-type: none"> • Pulse output: Pulse duration • Pulse width modulation: Output value • Pulse train: Number of pulses • On/Off-delay: Off-delay • Frequency output: Output frequency
Byte 2	Byte 6	Bit 7: Reserve = 0 Bit 6: Reserve = 0 Bit 5: Reserve = 0 Bit 4: Reserve = 0 Bit 3: Reserve = 0 Bit 2: SET_DO Bit 1: MANUAL_DO Bit 0: SW_ENABLE
Byte 3	Byte 7	Depending on the mode <ul style="list-style-type: none"> • Pulse output: On-delay factor • Pulse-width modulation: Period duration factor • Pulse train: Period duration factor • On/Off-delay: On-delay factor • Frequency output: On-delay factor

Assignment of the long control interface (12 bytes)

Address		Assignment
Channel 0	Channel 1	
Word 0	Word 6	Depending on the mode <ul style="list-style-type: none"> • Pulse output: Pulse duration • Pulse-width modulation: Output value • Pulse train: Number of pulses • On/Off-delay: Off-delay • Frequency output: Output frequency
Word 2	Word 8	Depending on the mode <ul style="list-style-type: none"> • Pulse output: On-delay • Pulse-width modulation: Time period • Pulse train: Time period • On/Off-delay: On-delay • Frequency output: On-delay
Byte 4	Byte 10	Bit 7: Reserve = 0 Bit 6: Reserve = 0 Bit 5: Reserve = 0 Bit 4: Reserve = 0 Bit 3: Reserve = 0 Bit 2: SET_DO Bit 1: MANUAL_DO Bit 0: SW_ENABLE
Byte 5	Byte 11	Depending on the mode <ul style="list-style-type: none"> • Pulse output: Not used • Pulse-width modulation: On-delay factor • Pulse train: Pulse-pause ratio • On/Off-delay: Not used • Frequency output: Not used

Assignment of the Feedback Interface

Address		Assignment
Channel 0	Channel 1	
Byte 0	Byte 4	Bit 7: ERR_24V Bit 6: ERR_DO Bit 5: ERR_PARA Bit 4: ERR_PULS Bit 3: ACK_SW_ENABLE Bit 2: STS_DI Bit 1: STS_DO Bit 0: STS_ENABLE
Byte 1	Byte 5	Bit 0 to Bit 3: Sequence counter SEQ_CNT Bit 4 to Bit 7: Reserve = 0
Word 2	Word 6	Measured value of the current

Note

Depending on the interface module IM 151 and the configuration, the feedback value (substitute value) supplied is 16#7FFF7FFF or 16#00000000.

Notes on the Control Signals

Control Signal	Notes
"Pulse output" operating mode:	
<ul style="list-style-type: none"> Pulse duration ^{1) 2)} 	The time that is set for the DO digital output on expiration of the on-delay.
<ul style="list-style-type: none"> On-delay factor ¹⁾ 	You can change the configured on-delay before the start of the output sequence: $\text{On-delay} = \text{Factor} \times 0.1 \times \text{configured on-delay}$
<ul style="list-style-type: none"> On-delay ²⁾ 	The time from the start of the output sequence to the output of the pulse train.
"Pulse width modulation" operating mode:	
<ul style="list-style-type: none"> Output value ^{1) 2)} 	Value that is output with pulse-width modulation at the DO digital output on expiration of the on-delay.
<ul style="list-style-type: none"> Time period factor ¹⁾ 	You can change the configured period duration: $\text{Period duration} = \text{Factor} \times 0.1 \times \text{configured period duration}$
<ul style="list-style-type: none"> Time period ²⁾ 	When specifying the time period take into account the set minimum pulse duration and the response time of your final controlling element that is connected to the digital output DO.
<ul style="list-style-type: none"> On-delay factor ²⁾ 	You can change the configured on-delay before the start of the output sequence: $\text{On-delay} = \text{Factor} \times 0.1 \times \text{configured on-delay}$

Control Signal	Notes
"Pulse train" operating mode:	
<ul style="list-style-type: none"> Number of pulses ^{1) 2)} 	Number of pulses that are output at the DO digital output on expiration of the on-delay.
<ul style="list-style-type: none"> Time period factor ¹⁾ 	You can change the configured time period before the start of the output sequence: Time period = Factor x 0.1 x configured time period
<ul style="list-style-type: none"> Time period ²⁾ 	When specifying the time period take into account the set minimum pulse duration and the response time of your final controlling element that is connected to the digital output DO.
<ul style="list-style-type: none"> Pulse-pause ratio ²⁾ 	You can set the ratio of the pulse duration to the interpulse period: Pulse-pause ratio = (Setpoint / 255) x time period
"On/Off-delay" operating mode:	
<ul style="list-style-type: none"> Off-delay ^{1) 2)} 	The time between a negative edge of the digital input DI and its output on the digital output DO.
<ul style="list-style-type: none"> On-delay factor ¹⁾ 	You can change the configured on-delay before the start of the output sequence: On-delay = Factor x 0.1 x configured on-delay
<ul style="list-style-type: none"> On-delay ²⁾ 	The time between a positive edge of the digital input DI and its output on the digital output DO.
"Frequency output" operating mode:	
<ul style="list-style-type: none"> Output frequency ^{1) 2)} 	Frequency that is output at the DO digital output after expiration of the on-delay.
<ul style="list-style-type: none"> On-delay factor ¹⁾ 	You can change the configured on-delay before the start of the output sequence: On-delay = Factor x 0.1 x configured on-delay
<ul style="list-style-type: none"> On-delay ²⁾ 	The time from the start of the output sequence to the output of the frequency.
Direct control of the digital output	
<ul style="list-style-type: none"> MANUAL_DO 	You use the control bit to select and deselect the function for directly controlling the digital output.
<ul style="list-style-type: none"> SET_DO 	You use the control bit to set the status of the digital output DO.
Software enable (SW_ENABLE)	You must always issue the software enable in your control program. If you don't use a HW enable, the output sequence will be started by the positive edge of the software enable. If you delete the software enable, the current output sequence will be terminated.

¹⁾ When using the short control interface

²⁾ When using the long control interface

Notes on the feedback signals

Checkback signal	Notes
ACK_SW_ENABLE	Indicates the status of the software enable pending at the 2PULSE.
ERR_24V	Indicates a short circuit or drop of the encoder supply.
ERR_DO	Indicates a short circuit at the digital output.
ERR_PARA	Indicates a parameter assignment error.
ERR_PULS	<p>"Pulse output" operating mode: Indicates a pulse output error. If the pulse duration is reduced after expiration of the on-delay so the time is less than the time already output, this is detected by the 2PULSE. The 2PULSE deletes the feedback bit ERR_PULS next time the output sequence starts.</p> <p>"Pulse train" operating mode: Indicates a pulse output error. If the number of pulses is reduced after expiration of the on-delay and the smaller number of pulses is already output, this is detected by the 2PULSE. The 2PULSE deletes the feedback bit ERR_PULS next time the output sequence starts.</p> <p>"On/Off-delay" mode: Indicates a pulse output error if the pulse duration or interpulse period is too short. The 2PULSE deletes the ERR_PULS feedback bit at the next positive edge of the software enable or at the next edge at the DI digital input.</p>
STS_DI	Indicates the signal level at the digital input DI.
STS_DO	Indicates the signal level at the digital output DO.
STS_ENABLE	<p>"Pulse output" operating mode: Is set at the start of the output sequence until the pulse duration expires. If you delete the software enable (SW_ENABLE) or the 2PULSE detects a pulse output error (ERR_PULS), STS_ENABLE is deleted.</p> <p>"Pulse-width modulation" operating mode: Set at start of output sequence. If you delete the software enable (STS_ENABLE), SW_ENABLE is deleted.</p> <p>"Pulse train" operating mode: Is set at the start of the output sequence until the output of the last pulse. If you delete the software enable (SW_ENABLE) or the 2PULSE detects a pulse output error (ERR_PULS), STS_ENABLE is deleted.</p> <p>"On/Off-delay" mode: Indicates the status of the software enable (SW_ENABLE) detected by the 2PULSE.</p> <p>"Frequency output" operating mode: Set at start of output sequence. If you delete the software enable (STS_ENABLE), SW_ENABLE is deleted.</p>
SEQ_CNT	<p>Counts the completed output sequences in the "Pulse output", "Pulse train" and "On/Off-delay" operating modes.</p> <p>No function in the "Pulse width modulation" and "Frequency output" operating modes.</p>
Measured value of the current	Current at the DO as a SIMATIC S7 analog value

Parameter List

Parameters	Value Range	Default
Group diagnostics	Disable/enable	Disable
Response to CPU/master STOP	Turn off DO/ Continue working mode/ DO substitute a value/ DO keep last value	Turn off DO
Parallel connection Channel 0 and 1	Off/on	Off
Channel 0		
Diagnostics DO	Off/on	On
Substitute value DO	0 / 1	0
Operating mode	Pulse output / Pulse width modulation (PWM) / Pulse train / On/Off-delay Frequency output	Pulse width modulation
Output format (in the "Pulse width modulation" operating mode)	Per mill/S7 analog output	Per mill
Output format (in the "Frequency output" operating mode)	1 Hz / S7 analog output	1 Hz
Time base	0.1 ms/1 ms	0.1 ms
Function DI	Input/HW enable	Input
On-delay	0 ... 65535	0
Minimum pulse duration	0 ... 65535	0
Time period	1 ... 65535 / 2 ... 65535	20000
Channel 1		
Diagnostics DO	Off/on	On
Substitute value DO	0 / 1	0
Operating mode	Pulse output / Pulse width modulation (PWM) / Pulse train / On/Off-delay Frequency output	Pulse width modulation
Output format (in the "Pulse width modulation" operating mode)	Per mill/S7 analog output	Per mill
Output format (in the "Frequency output" operating mode)	1 Hz / S7 analog output	1 Hz
Time base	0.1 ms/1 ms	0.1 ms
Function DI	Input/HW enable	Input
On-delay	0 ... 65535	0
Minimum pulse duration	0 ... 65535	0
Time period	1 ... 65535 / 2 ... 65535	20000

Index

1

- 1Count24V
 - Counting modes, 19
 - Isochrone mode, 12
 - Measuring modes, 54
 - Operating modes, 17
 - Technical specifications, 115
 - Terminal assignment, 16
- 1Count5V
 - Counting modes, 129
 - Isochronous mode, 122
 - Measuring Modes, 165
 - Operating modes, 127
 - Technical specifications, 228
 - Terminal assignment, 126
- 1SSI
 - Encoder types, 232
 - Encoder value detection, 241
 - In fast mode, 239
 - In standard mode, 239
 - Isochronous mode, 233
 - Normalization, 243
 - Technical Specifications, 261
 - Terminal assignment, 238

2

- 2PULSE
 - Application examples, 323
 - Direct control of the DO, 311
 - Frequency output, 303
 - Isochronous mode, 267
 - Measurement of current, 310
 - On/Off-delay, 295
 - Parallel connection of both channels, 315
 - Pulse output, 273
 - Pulse train, 289
 - Pulse width modulation, 279
 - Technical Specifications, 347
 - Terminal Assignment, 350

B

- Brief instructions on commissioning
 - 1Count24V, 13
 - 1Count5V, 123
 - 1SSI, 234
 - 2PULSE, 268

C

- Comparator of the 1SSI, 245
- Control and feedback interface
 - Accessing with STEP 7 programming, 49, 79, 104, 192, 217, 258
- Control interface
 - 1Count24V counting modes, 45
 - 1Count24V measuring modes, 75
 - 1Count24V position feedback, 101
 - 1Count5V counting modes, 155
 - 1Count5V measuring modes, 188
 - 1Count5V position feedback, 215
 - 1SSI standard mode, 256
 - 2PULSE (long), 352
 - 2PULSE (short), 351
- Count continuously, 21, 131
- Counting modes
 - Control interface, 45, 155
 - Feedback interface, 45, 155

D

- Direction detection, 244
- Direction reversal, 244

E

- Encoder value detection
 - Free-wheeling, 241
 - Isochronously, 241
 - Synchronous, 241

F

- Feedback interface
 - 1Count24V counting modes, 45
 - 1Count24V measuring modes, 75
 - 1Count24V position feedback, 101
 - 1Count5V counting modes, 155
 - 1Count5V measuring modes, 188
 - 1Count5V position feedback, 215
 - 1SSI fast mode, 259
 - 1SSI standard mode, 256
 - 2PULSE, 353
- Frequency Measurement, 59, 61, 172, 170

G

- Gate functions
 - in counting modes, 30, 139
 - in measuring modes, 72, 185
 - In position feedback, 93, 207

I

- Isochronous mode
 - 1Count24V, 12
 - 1Count5V, 122
 - 1SSI, 233
 - 2PULSE, 267

L

- Latch Function, 247

M

- Measuring
 - Frequency, 59, 61, 172
 - Period, 67, 69, 182
 - Rotational speed, 63, 65, 177
- Measuring modes
 - Control interface, 75, 188
 - Feedback interface, 75, 188
- Mode
 - Frequency measurement, 61, 172
 - Period measurement, 69, 182
 - Rotational speed measurement, 65, 177

P

- Parameters
 - 1Count24V counting modes, 52
 - 1Count24V measuring modes, 82
 - 1Count24V position feedback, 107
 - 1Count5V counting modes, 163
 - 1Count5V measuring modes, 195
 - 1Count5V position feedback, 221
 - 1SSI, 251
 - 2PULSE, 356
- Period Measurement, 67, 69, 182
- Periodic counting, 26, 136
- Position feedback, 92, 206
 - Control interface, 101, 215
 - Feedback interface, 101, 215

R

- Rotational speed measurement, 65, 177

S

- Single counting, 23, 133

T

- Technical Specifications
 - 1Count24V, 115
 - 1Count5V, 228
 - 1SSI, 261
 - 2PULSE, 347