



3/4	Introduction	3/88	Optical networks with OLM
3/5	Process or field communication	3/88	Overview of FC-FOCs
3/9	Data communication	3/90	FC glass fiber-optic cables
3/11	Communication overview	3/95	FC FO termination kit
3/13	Topologies	3/96	Glass fiber-optic cable
3/15	Network components	3/111	Plastic and PCF fiber-optic cable
3/15	Overview of network components	3/118	PCF-FOC termination kit
3/17	Network selection criteria	3/121	OLM Optical Link Module
3/20	Connection examples	3/134	Optical networks with OBT and integrated interface
3/22	Electrical networks (RS 485)	3/134	Plastic and PCF fiber-optic cable
3/22	PROFIBUS FastConnect	3/140	PCF-FOC termination kit
3/24	PROFIBUS bus cables	3/143	Optical bus terminal OBT
3/35	ECOFAS ^T bus cables	3/146	System interfaces for SIMATIC S7
3/40	Hybrid fieldbus connections	3/146	Introduction
3/42	Energy cables	3/148	<u>Communication for SIMATIC S7-1200</u>
3/47	RS485 bus connector	3/148	CM 1242-5
3/52	830-1T connecting cable	3/148	CM 1243-5
3/53	830-2 connecting cable	3/152	CM 1243-5
3/54	PROFIBUS M12 and 7/8" connecting cable/connector	3/156	<u>Communication for SIMATIC S7-1500</u>
3/61	Bus terminals	3/156	CM 1542-5
3/64	Active RS 485 terminating element	3/161	CP 1542-5
3/65	Repeater RS 485 for PROFIBUS	3/165	<u>Communication for SIMATIC S7-300</u>
3/67	Diagnostics repeater for PROFIBUS DP	3/165	CP 342-5
3/70	Electrical networks (PROFIBUS PA)	3/169	CP 342-5 FO
3/70	Introduction	3/173	<u>Communication for SIMATIC S7-400</u>
3/73	SpliTConnect	3/173	CP 443-5 Extended
3/77	Bus cables	3/178	Communication for SIMATIC S7 – software
3/80	Active field distributors		
3/85	Electrical networks (FOUNDATION Fieldbus)		
3/85	Bus cables		

PROFIBUS

3/179 System interfaces for PG/PC/IPC

- 3/179 Overview
- 3/180 Communication for PC-based systems
- 3/180 Performance data
- 3/181 Connection options to SIMATIC PCs
- 3/182 CP 5603
- 3/187 CP 5613 A3
- 3/191 CP 5614 A3
- 3/196 CP 5623
- 3/201 CP 5624
- 3/206 CP 5612
- 3/210 CP 5622
- 3/214 CP 5711
- 3/219 SOFTNET for PROFIBUS
- 3/222 OPC server for PROFIBUS
- 3/225 S7 OPC Redundancy for PROFIBUS
- 3/227 Software
- 3/229 PC adapter USB A2

3/231 System interfaces for SIMATIC HMI

- 3/231 System interfaces with WinCC (TIA Portal)
- 3/232 SIMATIC S7
- 3/234 SIMATIC WinCC (TIA Portal) Runtime
- 3/235 WinCC Runtime Communication
- 3/238 System interfaces with WinCC flexible
- 3/238 SIMATIC WinCC flexible RT
- 3/243 System interfaces with WinCC
- 3/243 SIMATIC WinCC

3/255 Network transitions

- Ch. 2 IE/PB Link PN IO
- 3/255 DP/DP coupler
- 3/256 PA routers
- Ch. 4 DP/AS-i LINK Advanced
- Ch. 4 DP/AS-Interface Link 20E
- Ch. 4 DP/AS-i F-Link

3/261 Industrial Controls

- 3/261 Soft Starters
- 3/261 3RW44 soft starters for High-Feature applications
- 3/263 Software
- 3/263 – Soft Starter ES
- 3/267 – SIRIUS 3RW44 Soft Starter block library for SIMATIC PCS 7
- 3/270 Motor starters for use in the field, high degree of protection
- 3/270 M200D motor starters for PROFIBUS
- 3/273 – Communication module, motor starter modules
- 3/274 – Accessories
- 3/276 Software
- 3/276 – Motor Starter ES
- 3/280 – SIRIUS motor starter block library for SIMATIC PCS 7
- 3/282 SIMOCODE 3UF Motor Management and Control Devices
- 3/282 SIMOCODE pro 3UF
- 3/282 – General data
- 3/288 – Basic units
- 3/290 – Expansion modules
- 3/292 – Fail-safe expansion modules
- 3/293 – Accessories
- 3/300 3UF18 current transformers for overload protection
- 3/301 SIRIUS 3RK3 Modular Safety System
- 3/301 General data
- 3/306 3RK31 central units
- 3/307 3RK32/33 expansion modules, 3RK35 interface modules, 3RK36 operating and monitoring modules
- 3/308 Accessories

3/310 Switching and Protection Devices for Power Distribution

3/310 SENTRON Communication-Capable Circuit Breakers

3/311 Power Monitoring

3/311 PC-based Power Monitoring System

3/314 SIMATIC-based Power Data Management System

3/316 SENTRON Measuring Devices

3/316 7KM PAC3200 Measuring Devices

3/318 7KM PAC4200 Measuring Devices

3/320 7KM PAC Switched Ethernet PROFINET Expansion Module

3/321 7KM PAC PROFIBUS DP Expansion Module

3/322 7KM PAC RS485 Expansion Module

3/323 7KM PAC 4DI/2DO Expansion Module for PAC4200

3/324 Configuring, Visualizing and Controlling with SIMATIC

3/324 Library 7KM PAC3200 for SIMATIC PCS

3/325 Library 3WL/3VL for SIMATIC PCS 7

3/326 Library 7KM PAC3200 for SIMATIC WinCC

3/327 Configuring, Visualizing and Controlling with SENTRON

3/327 powermanager

3/331 powerconfig

3/333 Industrial Identification Systems

3/333 ASM 456, SIMATIC RF160C

3/338 Engineering/Network Management/Diagnostics

Ch. 2 STEP 7 Professional/Basic V13 (TIA Portal)

Ch. 2 STEP 7

3/338 SIMATIC PDM

3/351 PROFIBUS Components

3/351 PROFIBUS DP ASICs

3/354 Connections/interfaces

3/355 Development kits

PROFIBUS

Introduction

Introduction

Overview

- Bus system
 - for process and field communication with field devices from different manufacturers
 - and for data communication acc. to IEC 61158/61784
- PROFIBUS – the fieldbus standard in production and process engineering comprises:
 - Specification of the standards for the physical characteristics of the bus and the access procedure
 - Specification of the user protocol and the user interface
- Offers openness for interfacing to standardized non-Siemens components
- Process or field communication
 - PROFIBUS DP for fast, cyclic data exchange with field devices
 - PROFIBUS PA for applications in process automation and in the intrinsically safe area
- Data communication
 - PROFIBUS FMS for data communication between programmable controllers of different manufacturers

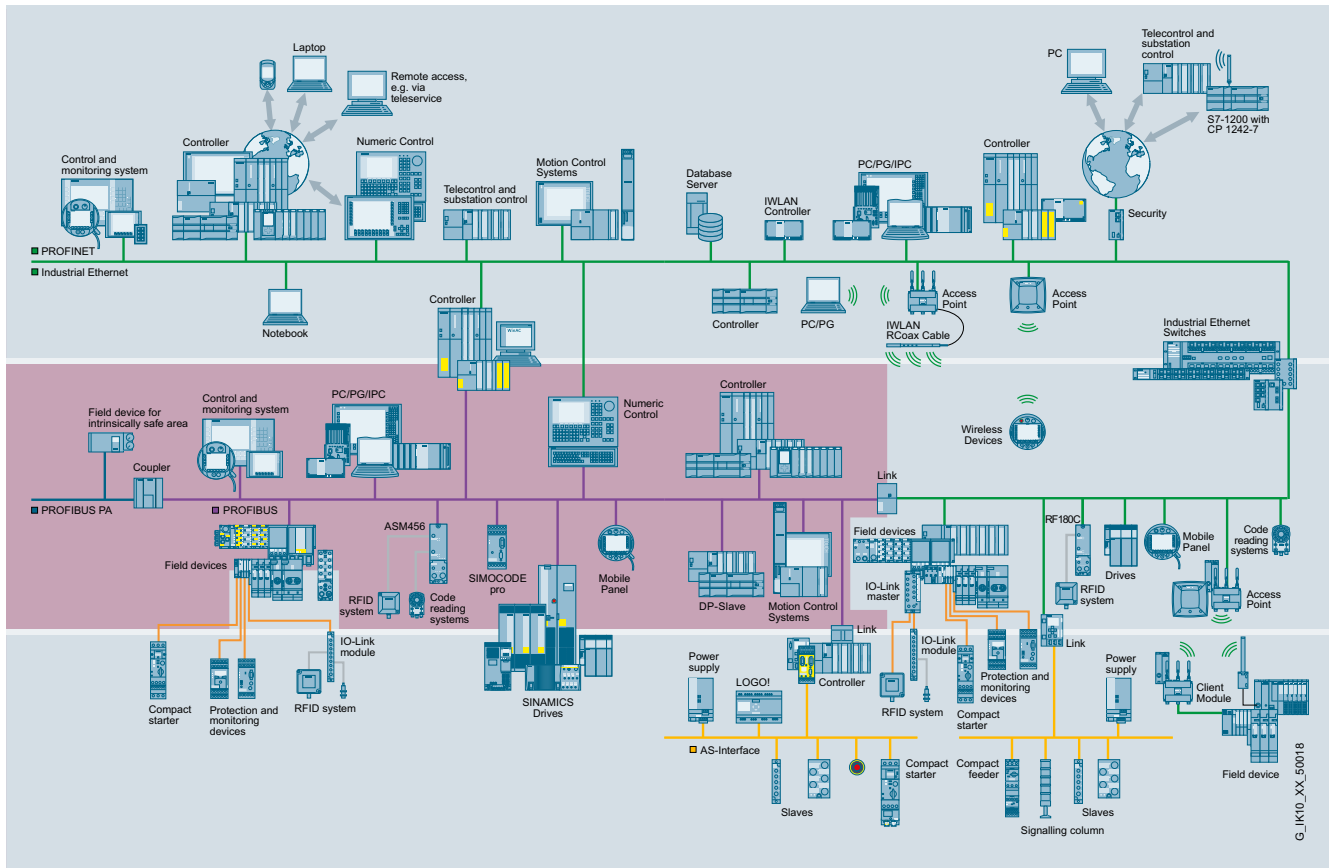

PROFIBUS in the communication landscape

Benefits

- get** Designed for Industry
- PROFIBUS is a powerful, open, and rugged bus system that ensures trouble-free communication.
 - The system is fully standardized, which enables trouble-free connection of standardized components from a variety of manufacturers.
 - Configuration, commissioning, and troubleshooting can be carried out from any location. This results in user-defined communication relationships that are very versatile, simple to implement, and easy to change.
 - Fast assembly and commissioning on site with the help of the FastConnect wiring system.
 - Continuous monitoring of network components through a simple and effective signaling concept.
 - High security of investment since existing networks can be extended without any adverse effects.
 - High availability through ring redundancy with OLM.

More information

Please always note the supplementary conditions for the specified SIMATIC NET products (order numbers 6GK..., 6XV1...), which you can view on the Internet pages below:

<http://www.siemens.com/simatic-net/ik-info>

Overview
Communication functions

Process or field communication (PROFIBUS DP, PROFIBUS PA) is used to link field devices to a programmable controller, HMI system or control system.

Interfacing is performed over integrated interfaces on the CPU or through interface modules (IMs) and communications modules (CPs, CMs).

With modern high-performance automation systems, it is often more effective to link more than one PROFIBUS DP line to one system, not just to increase the number of I/O devices that can be connected, but also to enable individual production areas to be handled independently of one another (segmentation).

PROFIBUS standardized to IEC 61158/61784 is a high-performance, open, rugged fieldbus system with short response times and the following protocols:

PROFIBUS DP

(Distributed I/O) is used to connect distributed I/O stations, such as SIMATIC ET 200 with extremely fast response times in accordance with the IEC 61158/EN 50170 standard.

PROFIBUS PA

(Process Automation) extends PROFIBUS DP with failsafe transmission technology in accordance with the international standard IEC 61158-2.

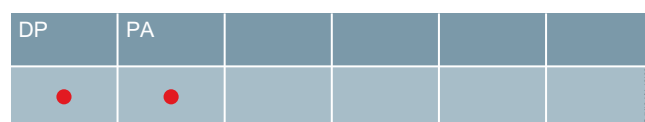

PROFIBUS

Introduction

Process or field communication

Overview (continued)

PROFIBUS is used to connect field devices, e.g. distributed I/O devices or drives, to automation systems such as SIMATIC S7, or PCs.

PROFIBUS is used when I/O devices are widely distributed on the machine or in the plant (e.g. at the field level) and can be combined into one station (e.g. ET 200), typically more than 16 inputs/outputs.

The actuators and sensors are connected to field devices. The field devices are supplied with output data in accordance with the master/slave technique and transfer input data to the programmable controller or PC.

High-performance tools such as STEP 7 are available for configuring and parameterizing the I/O devices. Testing and start-up is possible over PROFIBUS DP from any connection point using these tools.

3

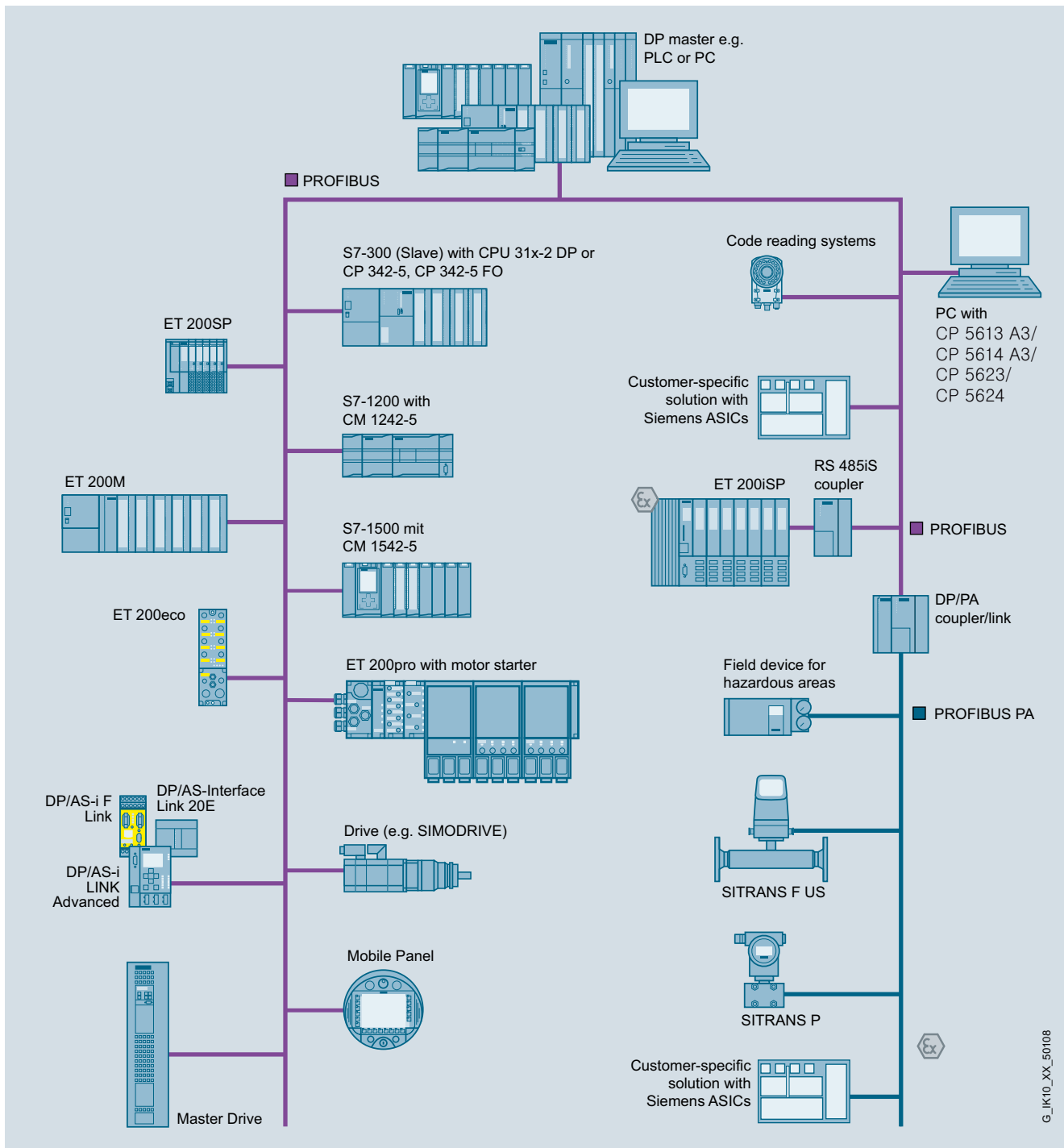

PROFIBUS DP slaves

G_IK10_XX_50108

Overview (continued)

DP device types

PROFIBUS DP distinguishes between two different master classes and different DP functions:

DP Master Class 1

The DP master Class 1 is the central component on PROFIBUS DP. The central controller or PC exchanges information with distributed stations (DP slaves) in a fixed, repeated message cycle.

DP Master Class 2

Devices of this type are used (programming, configuration or control devices) during start-up, for configuring the DP system or for controlling the plant during normal operation (diagnostics). A DP master Class 2 can be used, for example, to read the input, output, diagnostics and configuration data of the slaves.

DP slave

A DP slave is an I/O device that reads in input data and forwards output data to the I/O. The volume of input and output data depends on the device and can be up to 244 bytes.

The functional scope can differ between DP masters of Class 1 and 2 or DP slaves. This determines the performance and availability of a communications processor.

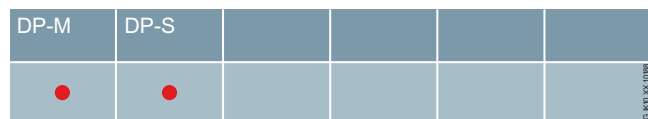
DP-V0

The DP master functions (DP-V0) comprise configuration, parameterization, read input data and write outputs in cycles, read diagnostics data.

DP-V1

The additional DP function expansions (DP-V 1) make it possible to perform non-isochronous read and write functions as well as acknowledgement of alarms at the same time as processing cyclic data communication. These extended DP functions comprise acyclic access to the parameters and measured values of a slave (e.g. field devices of process automation and intelligent HMI devices). This type of slave must be supplied with extensive parameter data during start-up and during normal operation. Data transferred in acyclic mode (e.g. parameterization data) are only rarely changed, in comparison to the cyclic measured values, and are transferred at lower priority in parallel with the cyclic high-speed useful data transfer. Alarm acknowledgement by the master ensures reliable transfer of the alarms from DP slaves.

DP-V2

The DP master functions (DP-V2) comprise functions for isochronous mode and direct data communication between DP slaves.

Isochronous mode

Isochronous mode is implemented by means of a signal with a constant bus cycle for the bus system. This isochronous, constant cycle is sent by the master to all bus stations in the form of a global control message. The master and slave can then synchronize their applications with this signal. The jitter of this signal from cycle to cycle must be less than 1 μ s for typical drive applications.

Direct data communication between DP slaves

The publisher/subscriber model is used to implement the direct data communication between slaves. Slaves declared as publishers make their input data (corresponds to response message to their own master) available to other slaves, the subscribers, for reading. Direct slave-to-slave communication is performed cyclically.

PROFIBUS

Introduction

Process or field communication

Integration

3

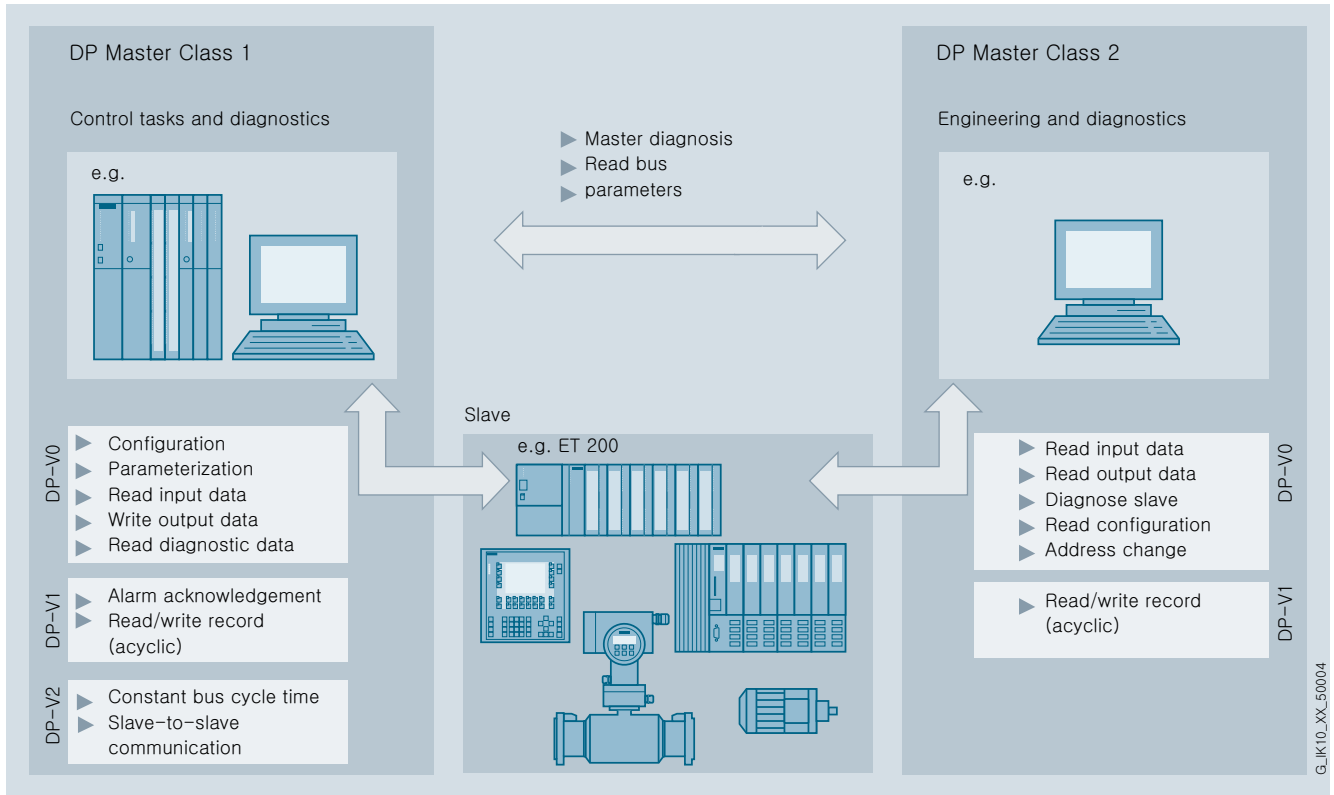

G_IK10_XX_50004

DP Master Classes

Overview

Communication functions

Data communication (e.g. PROFIBUS FMS) serves to exchange data between programmable controllers or between a programmable controller and intelligent partners (PC, computers, etc.).

The following communication functions are available for this purpose:

FMS communication

This is a standardized protocol for data communication via PROFIBUS.

- PROFIBUS FMS (Fieldbus Message Specification)

This is ideally suited to communication from different automation systems (e.g. PLCs, PCs) from different manufacturers at the cell level with only a few stations (max. 16). Communication with field devices using the FMS interface is also possible.

With the FMS services READ, WRITE and INFORMATION REPORT, read or write access to variables of the communication partner is possible from the user program by means of a variable index or variable name, or the user program can transfer its own variable values to a communications partner. Partial access to variables is supported. The communication is processed over acyclic connections (master-to-master, master-to-slave), over acyclic connections with a slave initiative or with cyclic connections (master-to-slave). The INFORMATION REPORT is also used to send a message to all stations on the network using a broadcast service. The FMS service IDENTIFY (request for identification characteristics of the partner) and STATUS (request partner status) can also be activated.

OPC-Server

The basic principle of OPC (Openness, Productivity & Collaboration) is that OPC client applications communicate with the OPC server over a standardized, open and manufacturer-independent interface.

The appropriate OPC servers are included in the scope of supply of the respective communication software.

PG/OP communication

Comprises integral communication functions that are used by the SIMATIC programmable controllers to perform data communication with HMI devices (e.g. TD/OP) and SIMATIC PG (STEP 7). PG/OP communication is supported by MPI, PROFIBUS and Industrial Ethernet networks.

S7 routing

With the aid of S7 routing it is possible to use the programming device communication across networks.

S7 communication

S7 communication is the integral communications function, which has been optimized within the SIMATIC. It enables PCs and workstations to be connected. The maximum volume of useful data per task is 64 KB. S7 communication offers simple, powerful communication services and provides a network-independent software interface for MPI, PROFIBUS and Industrial Ethernet networks.

Open communication

The open communication (SEND/RECEIVE) allows the SIMATIC S7 controllers to communicate with other SIMATIC S7 and SIMATIC S5 controllers, PCs, and third-party systems.

	FMS	OPC	PG/OP	S7/S5
	●	●	●	●

PROFIBUS

Introduction

Data communication

Overview (continued)

System connections

For many data terminals, communications processors (CPs) are available that already have the communications functions implemented in the firmware and that therefore relieve the data terminal of communications tasks (e.g. flow control, blocking, etc.).

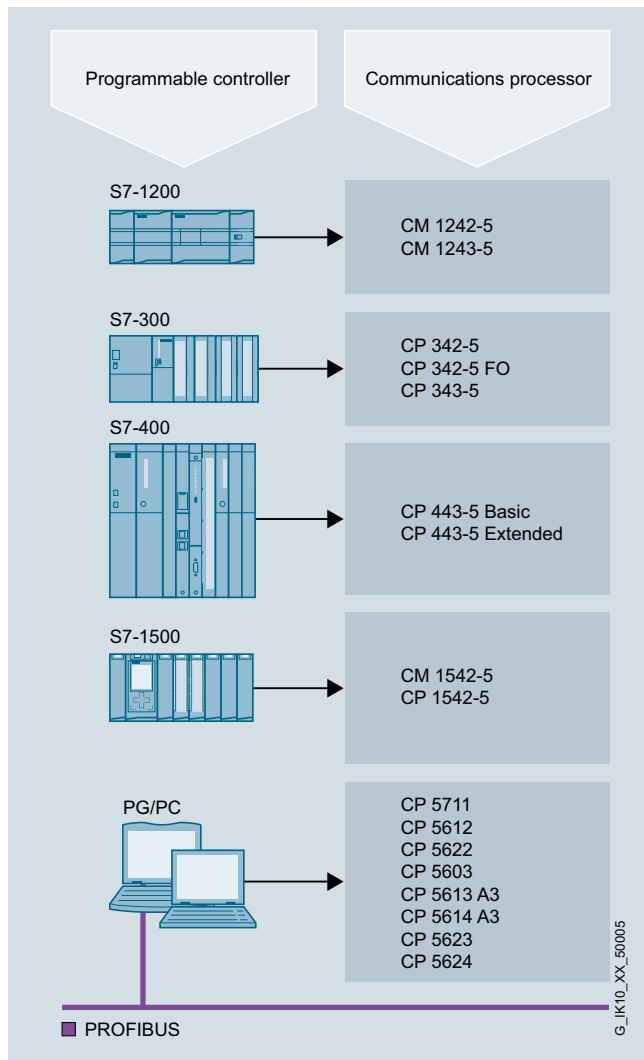

PROFIBUS system connections for SIMATIC and PC

Function

	Hardware	PROFIBUS DP			Open communication	S7 communication	PG/OP communication		Usage		Time		
		DP master cl.1	DP master cl.2	DP slave	Send/Receive			S7 routing	F system	H system	Sender	Receiver	Transfer
SIMATIC S7-1200	S7-1200 CPUs	No PB SS integrated !											
	CM 1243-5	• ¹⁾				•	•	•					
	CM 1242-5			•									
SIMATIC S7-1500	CPU 1511-1 PN	No PB SS integrated !											
	CPU 1513-1 PN	No PB SS integrated !											
	CPU 1516-3 PN/DP	•	•			•	•	•	• ³⁾		•	•	
	CM 1542-5	•	•	•		•	•	•	•		•	•	•
	CP 1542-5	• ²⁾	•	•			•	•	•		•	•	•
SIMATIC S7-300	S7-300 CPUs	•	•	•		○	•		• ³⁾		•	•	
	CP 343-5	•	•	•	•	•	•	•					
	CP 343-5 FO	•	•	•	•	•	•	•					
SIMATIC S7-400	S7-400 CPUs	•	•	•		•	•	•	• ³⁾	• ³⁾	•	•	
	CP 443-5 Extended	•	•		•	•	•	•	•	•		•	•
SIMATIC S7mEC	CP 5603	•	•	•	•	•	•						

1) 16 DP slaves maximum
 2) 32 DP slaves maximum
 3) special F- or H-CPU

• applies
 ○ with restrictions

G...IK10...XX_50199

Communications overview for SIMATIC

PROFIBUS

Introduction

Communication overview

Function (continued)

Hardware	Software	Operation system (64 Bit)				Operation system (32 Bit)					Other operation systems	OPC	PROFIBUS DP ⁵⁾			PG/OP	S7 communication	Open communication ⁷⁾
		Windows 8 Pro ⁷⁾	Windows 7 Professional / Ultimate ⁷⁾	Windows Server 2012 ⁷⁾	Windows Server 2008 R2 ⁷⁾	Windows 8 Pro ⁷⁾	Windows 7 Professional / Ultimate	Vista Business / Ultimate + SP1/2 ⁸⁾	Windows XP Pro + SP3 ⁸⁾	Windows Server 2008 + SP2 ⁸⁾			Windows Server 2003 SP2 ⁸⁾	DP MasterClass 1	DP MasterClass 2			
CP 5603 (PCI-104) CP 5613 A3 CP 5614 A3 (PCI 32 Bit) CP 5623 CP 5624 (PCIe x1)	CP with DP-Base ^{1) 4)}	•	•	•	•	•	•	•	•	•	•	•	•	•	•	•	•	•
	DK-5613											○ ⁵⁾	•	•	•			
	HARDNET-PB DP (DP-5613) ⁴⁾	•	•	•	•	•	• ⁹⁾	• ⁹⁾	• ⁹⁾	• ⁹⁾		•	•	•		•	•	•
	HARDNET-PB S7 (S7-5613)	•	•	•	•	•	• ⁹⁾	• ⁹⁾	• ⁹⁾	• ⁹⁾		•				•	•	•
	S7 OPC Redundancy for PROFIBUS				•							•					•	
CP 5612 (PCI 32 Bit) CP 5622 (PCIe x1) CP 5711 (USB V2.0)	SOFTNET-PB DP ²⁾	•	•	•	•	•	•	•	•	•		•	• ³⁾	• ³⁾		•	•	•
	SOFTNET-PB DP ²⁾ Slave	•	•	•	•	•	•	•	•	•		•			•			
	SOFTNET-PB S7	•	•	•	•	•	•	•	•	•		•				•	•	•
	S7 OPC Redundancy for PROFIBUS				•							•					•	
	STEP 7		•		•		•	•	•	•						•		
<p>You can find more information on the Internet http://www.siemens.com/simatic-net/ik-info If you have questions on LINUX projects please contact via e-mail it4industry@siemens.com</p>		<p>1) Included in scope of supply of the hardware 2) DP master and DP slaves cannot be operated simultaneously 3) Master Class 1 and Master Class 2 cannot be operated simultaneously on one CP (Exceptions: CP 5614 A3/CP 5624) 4) DP-Base and DP-5613 cannot be operated simultaneously</p>										<p>5) With porting via DK-5613 6) SEND/RECEIVE based on the FDL interface 7) on SIMATIC NET-DVD V12 8) on SIMATIC NET CD Edition 2008 SP6 9) not with CP 5613 A3/ CP 5614 A3</p>			<p>• suitable ○ suitable under certain conditions not applicable</p>			G_IK10_XX_50058

Communications overview for PG/PC

Overview

Siemens offers a comprehensive range of PROFIBUS network components for electrical and optical transmission technology.

PROFIBUS is standardized in accordance with IEC 61158/EN 50170 for universal automation (PROFIBUS FMS and PROFIBUS DP), and in accordance with IEC 61158-2 for process automation (PROFIBUS PA).

Electrical network

- The electrical network uses a shielded twisted pair cable. The RS 485 interface works with voltage differences. It is therefore less sensitive to interference than a voltage or current interface. With PROFIBUS, the stations are connected to the bus via a bus terminal or a bus connector (max. 32 stations per segment).
- The individual segments are connected via repeaters.
- The transmission rate can be set in steps from 9.6 Kbit/s to 12 Mbit/s.
- The maximum segment length depends on the transmission rate.
- The electrical network can be configured as a bus or tree structure
- For applications in the intrinsically-safe area, the transmission technology compliant with IEC 61158-2 is used with PROFIBUS PA. The transmission rate in this case is 31.25 Kbit/s.

Characteristics

- High-grade bus cable
- Transmission method: RS 485 (acc. to EIA)
- Bus topology with bus terminals and bus connectors for connecting PROFIBUS stations
- Transmission method in accordance with IEC 61158/EN 50170 for universal automation (PROFIBUS FMS/DP), and in accordance with IEC61158-2 for the intrinsically-safe area (PROFIBUS PA)
- The DP transmission system of RS 485 (bit coding by means of differential voltage signals) is converted to IEC 61158-2 (bit coding by means of current signals) using the network components (DP/PA coupler or DP/PA link)
- Simple, universal installation and grounding concept
- Easy installation

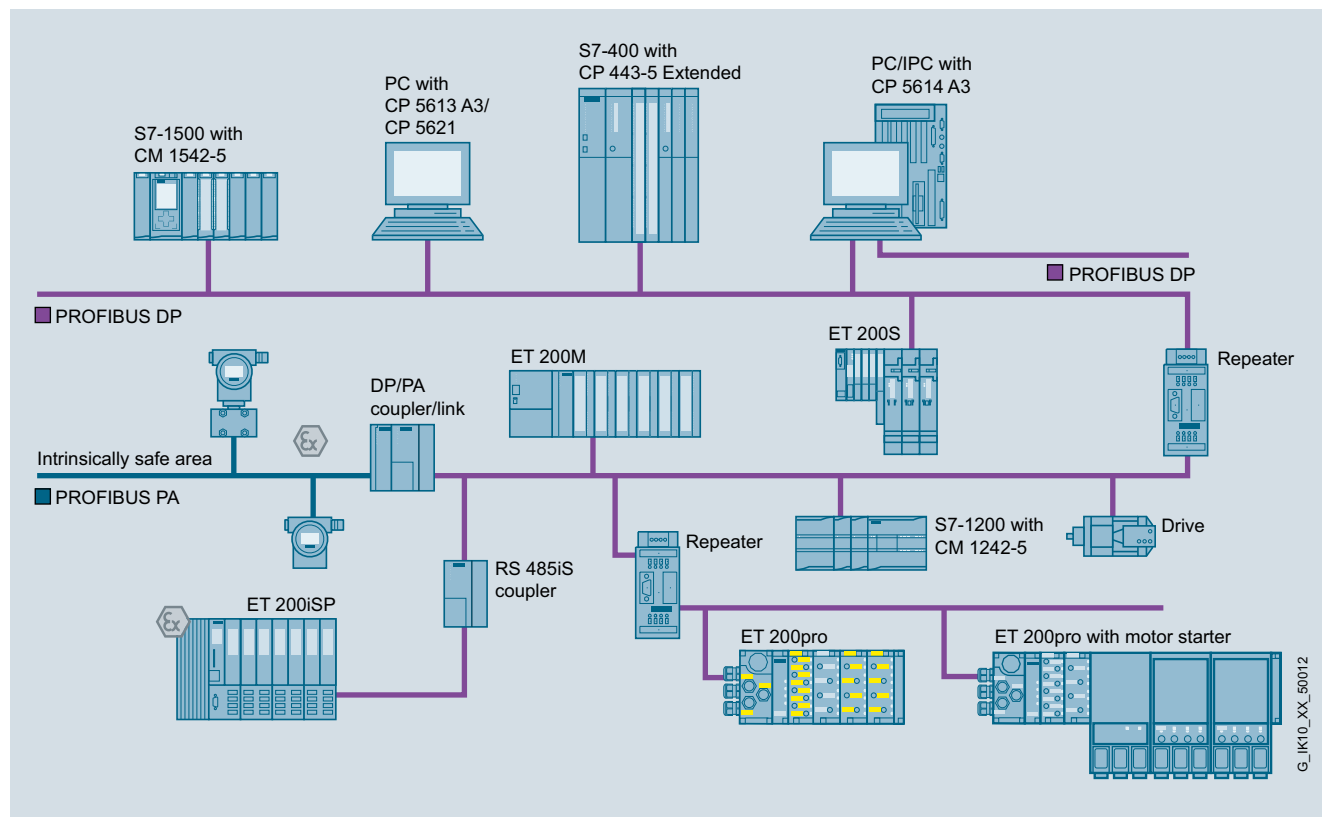

Electrical PROFIBUS network configuration

PROFIBUS

Introduction

Topologies

Overview (continued)

Optical network

The fiber-optic cable variant of PROFIBUS has the following characteristics:

- Transmission link is insensitive to electromagnetic influences
- Suitable for long ranges
- Galvanic isolation
- Uses either plastic, PCF or glass fiber-optic cables
- Avoidance of overvoltage and equipotential bonding problems

Optical PROFIBUS with OLMs

Using optical link modules (OLMs) it is possible to construct an optical network in a linear, ring, or star topology. The maximum distance between two OLMs is 15 km. The transmission rate can be set in steps from 9.6 Kbit/s to 12 Mbit/s.

Optical PROFIBUS with integral interface and OBT

The optical PROFIBUS with integral interface and OBT is constructed in a linear topology. A cost-optimized solution is available for this in the form of devices with integral optical interface. Terminal equipment with an RS 485 interface can be connected via an Optical Bus Terminal (OBT). The maximum distance between two nodes is 50 m in the case of plastic fiber-optic cables. Special fiber-optic cables are available to cover distances of up to 400 m.

Hybrid network

Hybrid electrical and optical networks are possible. The transition between both media is implemented by the OLM.

In station-to-station communication on the bus, there is no difference between two-wire technology and fiber-optic technology. A maximum of 127 stations can be connected to one PROFIBUS network.

The optical transmission technology offers the following advantages:

- Fiber-optic cables made of plastic or glass are not susceptible to electromagnetic interference and therefore render the EMC measures required for electrical networks unnecessary
- No additional lightning protection concept is required in the outdoor area
- The potentials on the modules are automatically separated thanks to the characteristics of the conductor
- With fiber-optic cables, long distances to field devices can be bridged.

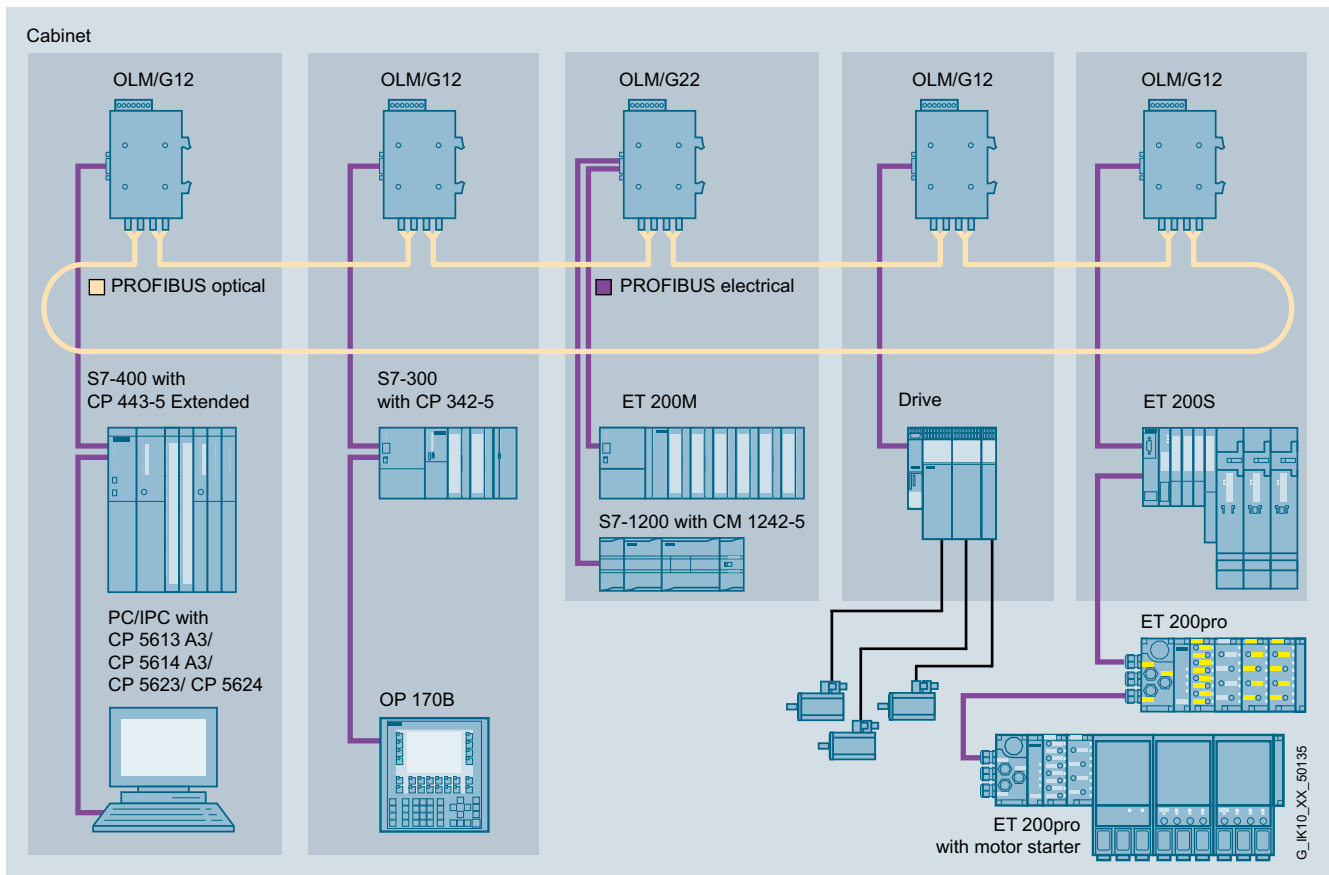

Network configuration combining electrical and optical PROFIBUS

More information

Please always note the supplementary conditions for the specified SIMATIC NET products (order number 6GK..., 6XV1...) that you can view on the Internet pages shown below:

<http://www.siemens.com/simatic-net/ik-info>

Overview

PROFIBUS	Maximum cable length for PROFIBUS connections						
	Type of fibre	0 - 80 m	0 - 100 m	0 - 200 m	0 - 400 m	0 - 3,000 m	0 - 10,000 m
PB FC Bus Cables							
PB FC Standard Cable GP / PB FC Standard Cable GP IS			● ⁴⁾	● ⁵⁾			
PB FC Robust Cable			● ⁴⁾	● ⁵⁾			
PB FC Food Cable			● ⁴⁾	● ⁵⁾			
PB FC Ground Cable			● ⁴⁾	● ⁵⁾			
PB FC Flexible Cable			● ⁴⁾	● ⁵⁾			
PB FC Trailing Cable			● ⁴⁾	● ⁵⁾			
PB FC FRNC Cable GP			● ⁴⁾	● ⁵⁾			
PB Festoon Cable GP			● ⁴⁾	● ⁵⁾			
PB Torsion Cable			● ⁴⁾	● ⁵⁾			
PYR FR Marine Cable			● ⁴⁾	● ⁵⁾			
PB Hybrid Standard Cable GP ¹⁾							
PB Hybrid Robust Cable ¹⁾							
PB FC Process Cable ¹⁾							
PB Cable for ET 200X ¹⁾							
PB ECOFAST Bus Cables							
PB ECOFAST Hybrid Cable ¹⁾							
PB ECOFAST Hybrid Cable GP ¹⁾							
PB Glass FOC with PB OLM							
FO Standard Cable GP	Multimode (50/125)					● ²⁾	● ³⁾
FO Ground Cable	Multimode (50/125)					● ²⁾	● ³⁾
FO Trailing Cable	Multimode (50/125)					● ²⁾	● ³⁾
FO Trailing Cable GP	Multimode (50/125)					● ²⁾	● ³⁾
INDOOR FO Indoor cable	Multimode (62.5/125)					● ²⁾	● ³⁾
FO Standard cable	Multimode (62.5/125)					● ²⁾	● ³⁾
Flexible FO Trailing cable	Multimode (62.5/125)					● ²⁾	● ³⁾
PB Plastic/POF/PCF FOC with PB OLM							
PB Plastic FO Standard Cable	Step index (980/1000)	●					
PB PCF FO Standard Cable	Step index (200/230)				●		
PCF Standard Cable GP	Step index (200/230)				●		
PCF Trailing Cable	Step index (200/230)				●		
PCF Trailing Cable GP	Step index (200/230)				●		
		1) Dependent on current load 2) at 860 nm 3) at 1310 nm 4) at 12 Mbit/s 5) at 1.5 Mbit/s Longer cables possible if data rate is reduced; see PROFIBUS Manual for further information					

G_IK10_XX_50196



PROFIBUS

Network components

Overview of network components

Overview (continued)

3

		Options for connecting PROFIBUS cables with plugs, terminals or devices													
		Electrical							Optical						
		PROFIBUS FC bus cables	PROFIBUS bus cables	Connecting cables	ECOFAST cable	Hybrid cable	Power cable	PROFIBUS FC Bus cable (PROFIBUS PA)	Bus terminal	Fiber-optic cable 50/125 µm	Fiber-optic cable 62.5/125 µm	PCF fiber optic cable 200/230 µm	POF-FOC 980/1000 µm	Fiber-optic cable with BFOC connector	Fiber-optic cable with Simplex connector
		PROFIBUS FC Standard Cable PROFIBUS FC Standard Cable IS GP PROFIBUS FC Robust Cable PROFIBUS FC Food Cable PROFIBUS FC Ground Cable PROFIBUS FC FRNC Cable PROFIBUS FC Trailing Cable	PROFIBUS Feestoon Cable PROFIBUS Flexible Cable	Connecting cable 830-2 Connecting cable 830-1T PROFIBUS M12 plug-in cable	ECOFAST Hybrid Cable ECOFAST Hybrid Cable GP	PROFIBUS Hybrid Standard Cable GP PROFIBUS Hybrid Robust Cable	Power Cable 5 x 1.5	PB FC Process Cable	12M bus terminal	FO Standard Cable GP FO Trailing Cable GP FO Ground Cable	FIBER OPTIC standard cable INDOOR Fiber optic trailing cable Flexible Fiber Optic trailing cable SIENOPYR marine duplex fiber-optic cable	PCF Standard Cable GP PCF Trailing Cable GP PCF Trailing Cable GP	Plastic fiber optic standard cable	Preassembled FOC with BFOC connector	Preassembled FOC with simplex connector
Electrical		PB FastConnect connector	•	•											
		PB bus connector	•	•											
		ECOFAST connector				•									
		PB M12 plug/socket (B-coded)	•	•											
		7/8" Power con						•							
		PB devices with Sub-D / M12 connector			•				•						
		ET 200pro	•	•											
	Bus terminal 12M	•	•												
	SplitConnect system							•							
Optical		BFOC connector								•	•	•			
		PB devices with BFOC connection											•		
		Simplex connector										•	•		
		PB devices with simplex connection												•	

G_IK10_XX_50013

Overview

Criteria	Electrical network		Optical network			
	RS 485 conforming to IEC 61158/ 61784	IEC 61158-2 (PA)	Plastic	PCF	Glass	
EMC	● ● ● ○	● ● ● ○	● ● ● ●	● ● ● ●	● ● ● ●	
Inter-building networking	● ● ○ ○ ¹⁾	● ● ○ ○	● ○ ○ ○	● ● ● ○ ⁵⁾	● ● ● ● ⁵⁾	
Operating distance	● ● ○ ○ ²⁾	● ● ○ ○	● ○ ○ ○	● ● ○ ○	● ● ● ●	
Suitability for high transmission rate	● ● ● ○ ⁴⁾	-	● ● ● ●	● ● ● ●	● ● ● ●	
Simple plug fitting	● ● ● ●	● ● ● ●	● ● ● ○	● ● ● ○ ³⁾	● ● ● ○ ³⁾	
Simple cable laying	● ● ● ○	● ● ● ○	● ● ○ ○	● ● ○ ○	● ● ○ ○	
Equipotential bonding measures required	Yes	Yes	No	No	No	
Performance spectrum for special applications	● ● ● ●	● ○ ○ ○	● ○ ○ ○	● ○ ○ ○	● ● ○ ○	
Used for moving nodes	● ● ○ ○ ⁶⁾	-	● ● ○ ○ ⁶⁾	● ● ○ ○ ⁶⁾	● ● ○ ○ ⁶⁾	
Use in intrinsically safe area	-	● ● ● ●	-	-	-	
1) Lightning protection measures required 2) Depending on transmission rate 3) Trained personnel and special tools necessary 4) Careful cable laying necessary 5) Outdoor cable required 6) Trailing cable required			● ● ● ● suitable ● ● ● ○ ● ● ○ ○ partly suitable ● ○ ○ ○ - not applicable			G_IK10_XX_50010

Summary of network selection criteria for transmission media

PROFIBUS

Network components

Network selection criteria

Overview (continued)

Criteria		Electrical network	Optical network	
		Electrical PROFIBUS	with OLM	with integr. interface/ OBT
Transition media	Plastic ¹⁾	-	●	●
	PCF	-	●	●
	Glass	-	●	-
	Shielded two-core cable	●	-	-
Distances	max. network size	9,6 km ⁵⁾	90 km	9,6 km
	between two nodes	up to 1 km ³⁾	up to 15 km ²⁾	up to 300 m ²⁾
Topology	Bus	●	-	-
	Line	-	●	●
	Tree	●	●	-
	Ring	-	●	-
Transmission protocols		all	all	DP
Connection of nodes via	OLM	-	●	-
	Integrated interfaces	●	-	● ⁴⁾
	Bus terminal	●	-	●
	Bus connector	●	-	-
Electr. network segments connectable		●	●	-
1) Plastic optical fiber is also referred to as polymer optical fiber (POF) 2) Depending on type of cable used 3) Depending on data rate used and performance 4) Integrated interfaces (ET 200M, ET 200X) 5) for PROFIBUS PA 1.9 km		● suitable - Irrelevant to this application		G_IK10_XX_50133

Selection criteria for electrical and optical networks

Overview (continued)

	Electrical network		Optical network	
	RS 485 in accordance with IEC 61158/EN 50170	IEC 61158-2 (PA)	with OLM	with integral interface/OBT
Network topology	Bus, tree	Bus, tree	Linear bus, star, ring	Linear bus
Transmission media	Shielded twisted-pair cable	Shielded twisted-pair cable for intrinsically-safe and non-intrinsically-safe areas	Plastic fiber optic cable PCF optic cable Glass fiber optic cable	Plastic fiber optic cable PCF optic cable
Tools and accessories	FastConnect stripping tool	FastConnect stripping tool	Tools for preparing BFOC connectors for plastic fiber optic cables	Tools for preparing Simplex connectors for plastic fiber optic cables
Connectors	Bus connector	SplitConnect system	BFOC connector	Simplex connector
Connection components	Bus terminal	SplitConnect system	OLM	OBT
Prepared cables	830-1T connecting cable 830-2 connecting cable	—	INDOOR cable with BFOC Standard glass cable with BFOC Trailing cable with BFOC Standard PCF cable with BFOC Standard plastic cable with BFOC	Standard PCF cable with Simplex connectors and pull cord feature
Lightning protection	Primary protection Secondary protection	to be implemented through design measures	Not required	Not required
Electrical network segment can be connected via	repeater	—	Optical Link Module (OLM)	Optical Bus Terminal (OBT)
Diagnostics tool	BT 200 hardware test device	Not available	Signal contact and integral measuring sockets; level measuring device on request	Level measuring device on request
Documentation	Manual for PROFIBUS networks	Manual for PROFIBUS networks	Manual for PROFIBUS networks	Manual for PROFIBUS networks

G_IK10_XX_50016

PROFIBUS network components and accessories

	Electrical PROFIBUS	Optical PROFIBUS/OLM	Optical PROFIBUS/int./OLM
Electrical PROFIBUS	Repeater	OLM	OBT
Optical PROFIBUS/OLM	OLM	OLM	OBT + OLM
Optical PROFIBUS/int./OBT	OBT	OBT + OLM	OBT, integr. optics

G_IK10_XX_50017

Transitions between the transmission media

PROFIBUS

Network components

Connection examples

Integration

3

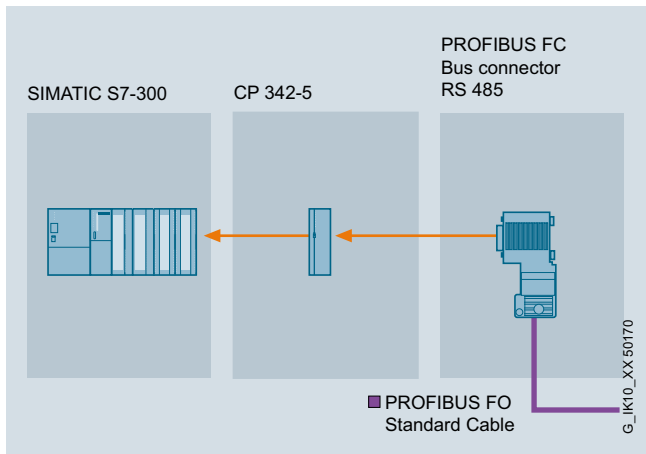

Typical connection for electrical networking with PROFIBUS FastConnect RS485 bus connector

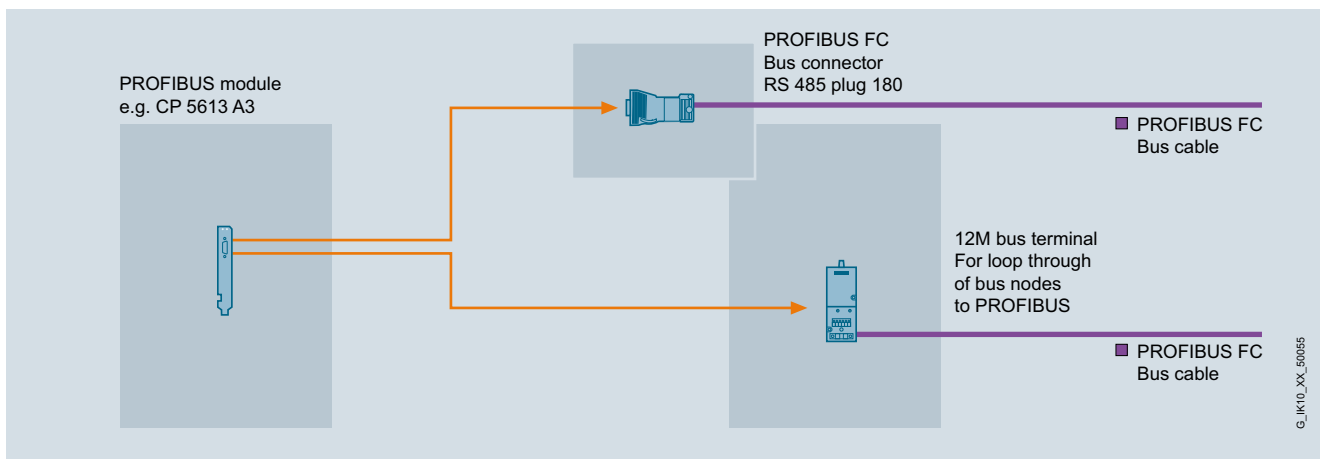

Typical connection for electrical networking with PROFIBUS FastConnect RS485 bus connector or bus terminal

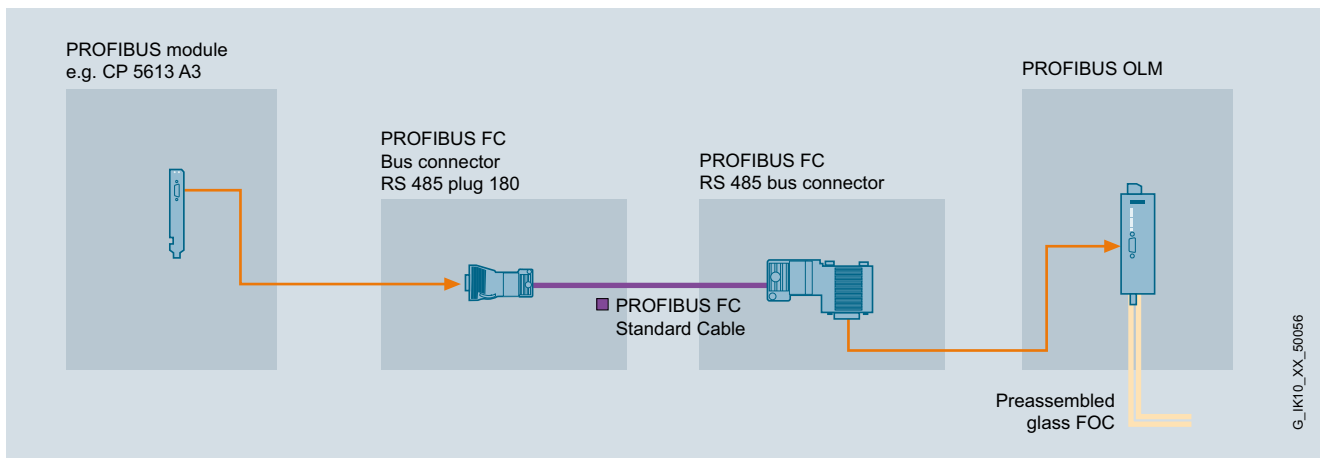

Connection example of optical networking

Integration (continued)

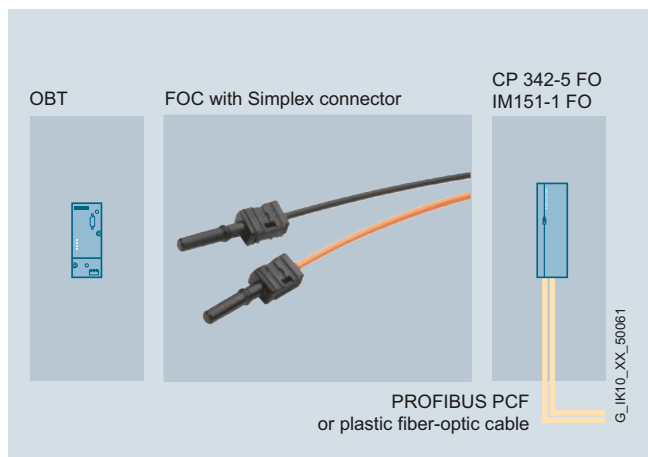

Connection example of optical networking with fiber-optic cables and Simplex connectors

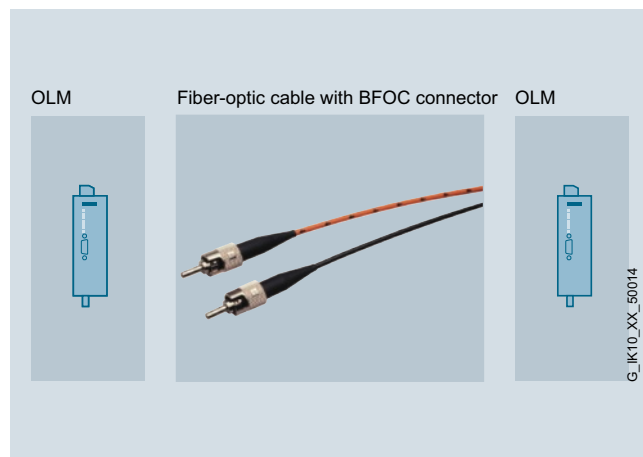

Connection example of optical networking with fiber-optic cables and BFOC connectors

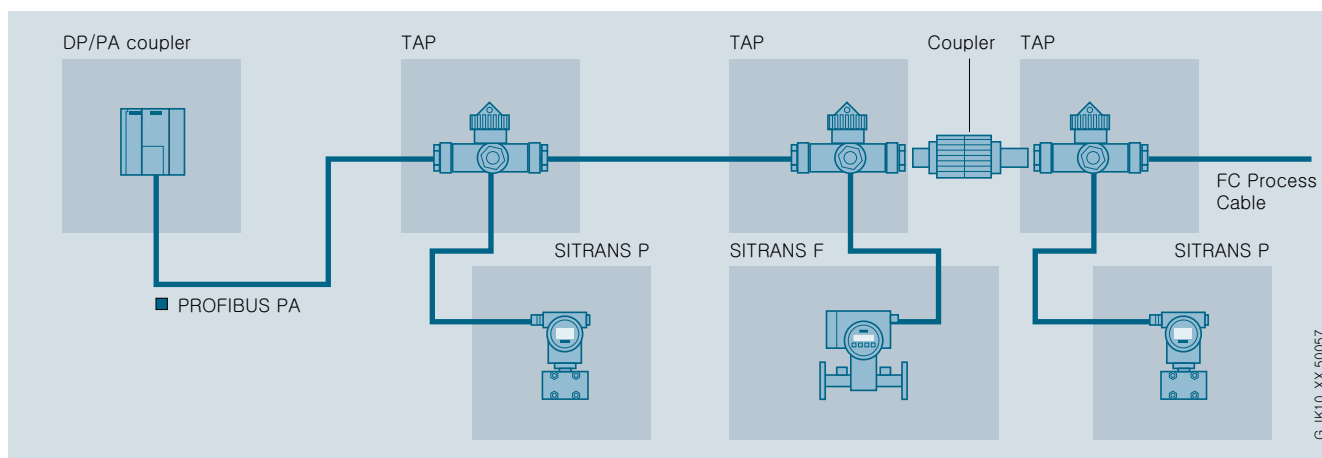

Connection example of an intrinsically-safe network with PROFIBUS PA

PROFIBUS

Electrical networks (RS485)

PROFIBUS FastConnect

Overview



- Quick and easy assembly of PROFIBUS copper cables
- Assembly mistakes such as short-circuits between the shield and core are excluded

Benefits

get **Designed for Industry**

- Shorter connection times for terminals by stripping of the outer cladding and woven shield in one step
- Installation faults, such as short-circuits between the shield and cores, are excluded
- Easy assembly due to preset insulation stripping tool (FC stripping tool)
- Termination can be checked in the assembled state through the transparent cover for the insulation piercing terminals thanks to color coding.

Design

The system comprises 3 compatible components:

- FastConnect bus cables for rapid installation
- FastConnect stripping tool
- FastConnect bus connector for PROFIBUS

The PROFIBUS FastConnect bus cables can also be connected to conventional bus connectors.

Function

The FastConnect stripping method enables fast and easy connection of PROFIBUS connectors to the PROFIBUS cables.

The special structure of the FastConnect bus cables enables the use of the FastConnect stripping tool with which the outer casing and the woven shield can be stripped in one operation with perfect precision. The cable prepared in this way is connected in the FastConnect bus connector using the insulation displacement method.

Application

PROFIBUS FastConnect is a system for fast and easy assembly of PROFIBUS copper cables.

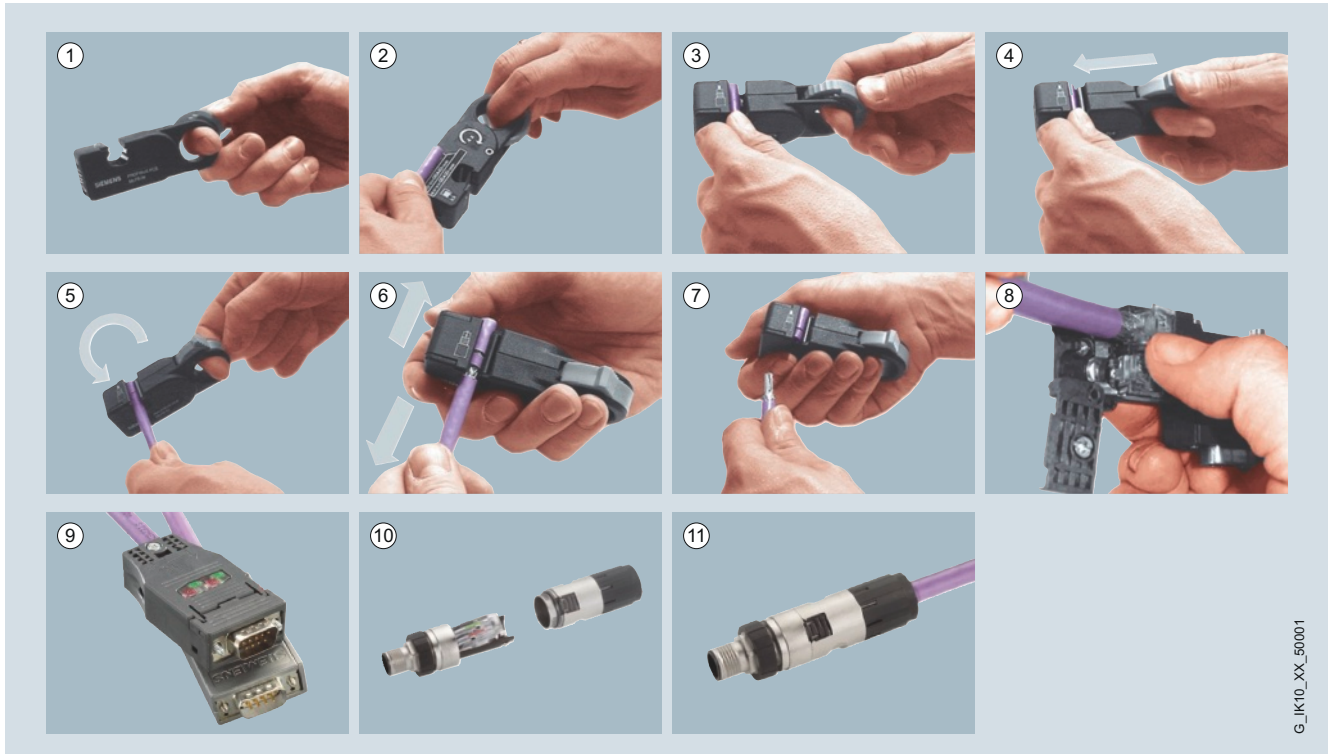

Steps in assembling PROFIBUS copper cables with PROFIBUS FastConnect

PROFIBUS

Electrical networks (RS 485)

PROFIBUS bus cables

Overview

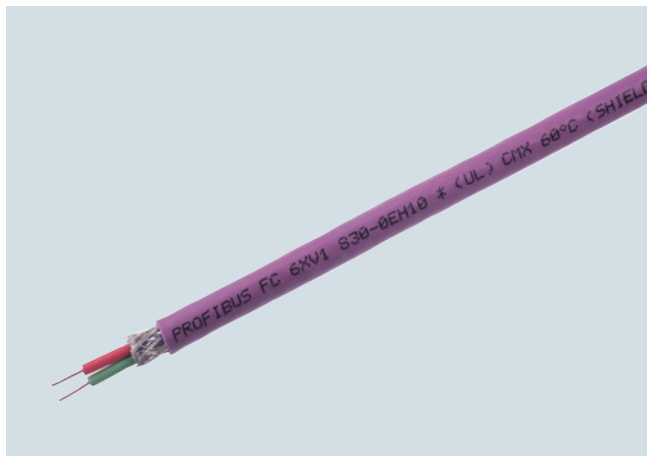

- Different variants for different application areas (e.g. underground cables, trailing cables, hazardous area Zone 1 and Zone 2)
- High interference immunity thanks to double shielding
- Flame-retardant bus cable (halogen-free)
- Easy length measurement thanks to printed meter markings
- UL approvals

Benefits



- Flexible application possibilities thanks to special bus cables
- Network is immune to interference thanks to double shielded cables and a uniform grounding concept
- Time saving due to simple and fast connector assembly with FastConnect cables
- Silicon-free, therefore particularly suitable for use in the automotive industry (e.g. on paint shop conveyors)

Application

For the construction of PROFIBUS DP networks, different cable types are offered to suit the different types of applications. The listed bus cables should always be used. For further information on network configuration, see the PROFIBUS network manual.

UL approvals

UL listing (safety standard) for network cables is especially necessary for the American and Canadian markets. The requirements for the appropriate approvals depend on where the cable is routed within the building. This applies to all cables which have to be routed from a machine to a remote control cabinet and are positioned on cable racks secured on the building. Cables with UL approval have "GP" (General Purpose) added to their name.

Ex approval

Cables for intrinsically safe PROFIBUS DP applications have "IS" (intrinsically safe) added to their names

Design

Shielded, twisted-pair cable with circular cross-section

The following applies for all PROFIBUS bus cables:

- The double shield makes it especially suitable for routing through industrial areas with strong electro-magnetic fields
- System-wide grounding concept can be implemented using the external shield of the bus cable and the grounding terminals on the bus terminal
- Printed meter marks

Cable types

The shape of the FastConnect (FC) bus cables is radially symmetric and allows an insulation stripping tool to be used. This means that bus connectors can be assembled quickly and easily.

- PROFIBUS FC Standard Cable GP: Standard bus cable specially designed for fast installation
- PROFIBUS FC Standard Cable IS GP: Standard bus cable with special design for quick installation for intrinsically safe distributed I/O systems
- PROFIBUS FC Robust Cable: Special cable for use in corrosive atmospheres and under severe mechanical loading
- PROFIBUS FC Food Cable: The PE casing of the cable makes this cable suitable for use in the food and tobacco industry
- PROFIBUS FC Ground Cable: Special cable for laying underground. It differs from the PROFIBUS bus cable in that it has an additional sheath
- PROFIBUS FC Flexible Cable: Flexible (stranded conductors), halogen-free bus cable with PUR sheath for occasional moving
- PROFIBUS FC Trailing Cable: Bus cable specially designed for forced motion control in a trailing cable, e.g. with continuously moving machine parts (stranded core)
- PROFIBUS FC FRNC Cable GP: Two-core, shielded, flame-retardant, halogen-free bus cable with Copolymer outer sheath FRNC (Flame Retardant Non Corrosive)

Bus cables without FastConnect technology (due to type of construction)

- PROFIBUS Festoon Cable GP: Flexible bus cable (stranded cores) specially designed for festoon suspension. For round cables, cable-carrying trolleys are recommended
- PROFIBUS Torsion Cable: Bus cable for highly flexible applications: Special cable (stranded cores) for use on moving parts of machines (5 million torsion movements on 1 m length of cable, $\pm 180^\circ$)
- PROFIBUS Hybrid Cable GP: Rugged hybrid cable suitable for trailing with two copper conductors for data transmission and two copper conductors for the power supply of ET 200pro
- SIENOPYR FR marine cable: Halogen-free, non-crush, flame-retardant, marine-approved cable for permanent installation on ships and offshore platforms indoors and on open deck. Sold by the meter.

Technical specifications

Article No.	6XV1830-0EH10	6XV1831-2A	6XV1830-0JH10	6XV1830-0GH10
Product-type designation	PROFIBUS FC Standard Cable GP	PROFIBUS FC Standard Cable IS GP	PROFIBUS FC Robust Cable	PROFIBUS FC Food Cable
Product description	Standard bus cable (2-core), sold by the meter, in bulk	Standard bus cable (2-core), sold by the meter, in bulk	Standard bus cable (2-core), sold by the meter, in bulk	Standard bus cable (2-core), sold by the meter, in bulk
Acceptability for application	Standard cable specially designed for fast, permanent installation	Used for intrinsically safe distributed I/O systems for permanent installation	For use in chemically and mechanically demanding environments	For use in the food, beverages and tobacco industries
Cable designation	02YSY (ST) CY 1x2x0.64/2.55-150 VI KF 40 FR	02YSY (ST) CY 1x2x0.64/2.55 BL KF40 FR	02YSY (ST) C11Y 1x2x0.64/2.55-150 VI KF 40 FR	02YSY (ST) C2Y 1x2x0.64/2.55-150 KF 40
Electrical data				
Damping ratio per length				
• at 9.6 kHz maximum	2.5 dB/km	2.5 dB/km	2.5 dB/km	2.5 dB/km
• at 38.4 kHz maximum	4 dB/km	4 dB/km	4 dB/km	4 dB/km
• at 4 MHz maximum	22 dB/km	22 dB/km	22 dB/km	22 dB/km
• at 16 MHz maximum	42 dB/km	42 dB/km	42 dB/km	42 dB/km
Impedance				
• Nominal value	150 Ω	150 Ω	150 Ω	150 Ω
• at 9.6 kHz	270 Ω	270 Ω	270 Ω	270 Ω
• at 38.4 kHz	185 Ω	185 Ω	185 Ω	185 Ω
• for frequency range 3 MHz ... 20 MHz	150 Ω	150 Ω	150 Ω	150 Ω
Relative symmetrical tolerance				
• of the surge impedance at 9.6 kHz	10 %	10 %	10 %	10 %
• of the surge impedance at 38.4 kHz	10 %	10 %	10 %	10 %
• of the surge impedance at 3 MHz ... 20 MHz	10 %	10 %	10 %	10 %
Loop resistance per length maximum	110 Ω/km	110 Ω/km	110 Ω/km	110 Ω/km
Shield resistance per length maximum	9.5 Ω/km	9.5 Ω/km	9.5 Ω/km	9.5 Ω/km
Capacity per length at 1 kHz	28.5 pF/m	28.5 pF/m	28.5 pF/m	28.5 pF/m
Operating voltage RMS value	100 V	100 V	100 V	100 V
Mechanical data				
Number of electrical wires	2	2	2	2
Design of shield	Overlapped aluminum-clad foil, sheathed in a braided screen of tin-plated copper wires	Overlapped aluminum-clad foil, sheathed in a braided screen of tin-plated copper wires	Overlapped aluminum-clad foil, sheathed in a braided screen of tin-plated copper wires	Overlapped aluminum-clad foil, sheathed in a braided screen of tin-plated copper wires
Design of the electrical connection FastConnect	Yes	Yes	Yes	Yes
Outer diameter				
• of the inner conductor	0.65 mm	0.64 mm	0.65 mm	0.65 mm
• of the wire insulation	2.55 mm	2.55 mm	2.55 mm	2.55 mm
• of the inner sheath of the cable	5.4 mm	5.4 mm	5.4 mm	5.4 mm
• of the cable sheath	8 mm	8 mm	8 mm	8 mm
Symmetrical tolerance of outer diameter of cable sheath	0.4 mm	0.4 mm	0.4 mm	0.4 mm
Material				
• of the wire insulation	PE	PE	PE	PE
• of the inner sheath of the cable	PVC	PVC	PVC	PVC
• of the cable sheath	PVC	PVC	-	PE
- Note	-	-	-	Outer PE sheath particularly suitable for the food sector

PROFIBUS**Electrical networks (RS 485)****PROFIBUS bus cables****Technical specifications (continued)**

Article No.	6XV1830-0EH10	6XV1831-2A	6XV1830-0JH10	6XV1830-0GH10
Product-type designation	PROFIBUS FC Standard Cable GP	PROFIBUS FC Standard Cable IS GP	PROFIBUS FC Robust Cable	PROFIBUS FC Food Cable
Color				
• of the insulation of data wires	red / green	red / green	red / green	red / green
• of the cable sheath	Violet	Blue	Violet	Black
Bending radius				
• with single bend	37.5 mm	37.5 mm	37.5 mm	30 mm
• with multiple bends	75 mm	75 mm	75 mm	60 mm
Traction stress maximum	100 N	100 N	100 N	100 N
Weight per length	80 kg/km	80 kg/km	71 kg/km	67 kg/km
Permitted ambient conditions				
Ambient temperature				
• during operating	-40 ... +75 °C	-40 ... +75 °C	-40 ... +60 °C	-40 ... +60 °C
• during storage	-40 ... +75 °C	-40 ... +75 °C	-40 ... +60 °C	-40 ... +60 °C
• during transport	-40 ... +75 °C	-40 ... +75 °C	-40 ... +60 °C	-40 ... +60 °C
• during installation	-40 ... +75 °C	-40 ... +75 °C	-40 ... +60 °C	-40 ... +60 °C
Burning behaviour	flame resistant according to IEC 60332-3-24 (Category C) and UL 1685 (CSA FT 4)	flame resistant according to IEC 60332-3-24 (Category C)	flame resistant according to IEC 60332-1	inflammable
Chemical resistance				
• to mineral oil	oil resistant according to IEC 60811-2-1 (4 hours / 70°C)	oil resistant according to IEC 60811-2-1 (4 hours / 70°C)	oil resistant according to IEC 60811-2-1 (7x24 hours / 90°C)	oil resistant according to IEC 60811-2-1 (4 hours / 70°C)
• to grease	Conditional resistance	Conditional resistance	Resistant	Conditional resistance
• to water	Conditional resistance	Conditional resistance	Conditional resistance	Conditional resistance
Radiological resistance to UV radiation	Resistant	Resistant	Resistant	Resistant
Product properties, functions, components general				
Product feature				
• halogen-free	No	No	No	No
• silicon-free	Yes	Yes	Yes	Yes
Cable length				
Standards, specifications, approvals				
UL/ETL listing with 300 V rating	Yes: c(UL)us, CMG / CL3 / Sun Res	Yes: CMG / CL3 / Sun Res	Yes: c(UL)us, CMX	No
UL/ETL style with 600 V rating	Yes	Yes	No	No
Verification of suitability				
• CE mark	Yes	Yes	Yes	Yes
• UL-registration	Yes	-	-	-
• RoHS conformity	Yes	Yes	Yes	Yes
Marine classification association				
• Germanische Lloyd (GL)	No	No	No	No
• Lloyds Register of Shipping (LRS)	No	No	No	No

Technical specifications (continued)

Article No.	6XV1830-3FH10	6XV1831-2K	6XV1830-3EH10	6XV1831-2L
Product-type designation	PROFIBUS FC Ground Cable	PROFIBUS FC Flexible Cable	PROFIBUS FC Trailing Cable	PROFIBUS FC Trailing Cable
Product description	Special bus cable (2-core) with additional outer shield, sold by the meter, in bulk	Flexible bus cable (4-core), sold by the meter, in bulk	Highly flexible bus cable (2-core), sold by the meter, in bulk	Highly flexible bus cable (2-core), sold by the meter, in bulk
Acceptability for application	Used for buried cables	For occasionally moved machine parts	Continuous motion control in a cable carrier	Continuous motion control in a cable carrier
Cable designation	02YSY (ST) CY2Y 1x2x0.64/2.55-150 SW KF 40	02YH (ST) C11Y 1x2x0.65/2.56-150 LI KF40 FRNC FC VI	02YY (ST) C11Y 1x2x0.65/2.56-150 LI KF 40 FR petrol	02YY (ST) C11Y 1x2x0.65/2.56-150 LI KF 40 FR VT FC
Electrical data				
Damping ratio per length				
• at 9.6 kHz maximum	2.5 dB/km	3 dB/km	3 dB/km	3 dB/km
• at 38.4 kHz maximum	4 dB/km	4 dB/km	4 dB/km	4 dB/km
• at 4 MHz maximum	22 dB/km	25 dB/km	25 dB/km	25 dB/km
• at 16 MHz maximum	42 dB/km	49 dB/km	49 dB/km	49 dB/km
Impedance				
• Nominal value	150 Ω	150 Ω	150 Ω	150 Ω
• at 9.6 kHz	270 Ω	270 Ω	270 Ω	270 Ω
• at 38.4 kHz	185 Ω	185 Ω	185 Ω	185 Ω
• for frequency range 3 MHz ... 20 MHz	150 Ω	150 Ω	150 Ω	150 Ω
Relative symmetrical tolerance				
• of the surge impedance at 9.6 kHz	10 %	10 %	10 %	10 %
• of the surge impedance at 38.4 kHz	10 %	10 %	10 %	10 %
• of the surge impedance at 3 MHz ... 20 MHz	10 %	10 %	10 %	10 %
Loop resistance per length maximum	110 Ω/km	133 Ω/km	133 Ω/km	133 Ω/km
Shield resistance per length maximum	9.5 Ω/km	15 Ω/km	14 Ω/km	14 Ω/km
Capacity per length at 1 kHz	28.5 pF/m	28 pF/m	28 pF/m	28 pF/m
Operating voltage RMS value	100 V	100 V	100 V	100 V
Mechanical data				
Number of electrical wires	2	2	2	2
Design of shield	Overlapped aluminum-clad foil, sheathed in a braided screen of tin-plated copper wires	Overlapped aluminum-clad foil, sheathed in a braided screen of tin-plated copper wires	Overlapped aluminum-clad foil, sheathed in a braided screen of tin-plated copper wires	Overlapped aluminum-clad foil, sheathed in a braided screen of tin-plated copper wires
Design of the electrical connection FastConnect	Yes	Yes	Yes	Yes
Outer diameter				
• of the inner conductor	0.65 mm	0.67 mm	0.67 mm	0.67 mm
• of the wire insulation	2.55 mm	2.56 mm	2.56 mm	2.56 mm
• of the inner sheath of the cable	5.4 mm	5.4 mm	5.4 mm	5.4 mm
• of the cable sheath	10.8 mm	8 mm	8 mm	8 mm
Symmetrical tolerance of outer diameter of cable sheath	0.5 mm	0.4 mm	0.4 mm	0.4 mm
Outer diameter of the cable sheath Note	The cable (diameter 8.0 mm +/-0.4 mm) has an additional, black, outer sheath (diameter 10.8 mm +/-0.5 mm) as protection against damage caused by routing underground. Due to outer diameter > 8 mm: Bus connectors can only be connected after the outer sheath has been stripped	-	-	-

PROFIBUS

Electrical networks (RS 485)

PROFIBUS bus cables

Technical specifications (continued)

Article No.	6XV1830-3FH10	6XV1831-2K	6XV1830-3EH10	6XV1831-2L
Product-type designation	PROFIBUS FC Ground Cable	PROFIBUS FC Flexible Cable	PROFIBUS FC Trailing Cable	PROFIBUS FC Trailing Cable
Material				
• of the wire insulation	PE	PE	PE	PE
• of the inner sheath of the cable	PVC	FRNC	PVC	PVC
• of the cable sheath	PE/PVC	PUR	PUR	PUR
- Note	PVC (cable casing), PE (additional outer sheath)	-	-	-
Color				
• of the insulation of data wires	red / green	red / green	red / green	red / green
• of the cable sheath	Black	Violet	Petrol	Violet
Bending radius				
• with single bend	41 mm	40 mm	40 mm	40 mm
• with multiple bends	81 mm	120 mm	-	-
• with continuous bending	-	-	120 mm	120 mm
Number of bending cycles	-	-	3 000 000	3 000 000
• Note	-	-	-	For use in cable carriers, for 3 million bending cycles with a bending radius of 120 mm (15x D) and an acceleration of 4 m/s ²
Traction stress maximum	100 N	100 N	100 N	100 N
Weight per length	117 kg/km	70 kg/km	77 kg/km	77 kg/km
Permitted ambient conditions				
Ambient temperature				
• during operating	-40 ... +60 °C	-20 ... +60 °C	-40 ... +60 °C	-40 ... +60 °C
• during storage	-40 ... +60 °C	-40 ... +60 °C	-40 ... +60 °C	-40 ... +60 °C
• during transport	-40 ... +60 °C	-40 ... +60 °C	-40 ... +60 °C	-40 ... +60 °C
• during installation	-40 ... +60 °C	-40 ... +60 °C	-40 ... +60 °C	-40 ... +60 °C
Ambient condition for (standard) operation mode	-	Limited segment length (see manual for PROFIBUS networks)	Limited segment length (see manual for PROFIBUS networks)	Limited segment length (see manual for PROFIBUS networks)
Burning behaviour	inflammable	flame resistant according to IEC 60332-1-2	flame resistant according to IEC 60332-1-2	flame resistant according to IEC 60332-1-2
Chemical resistance				
• to mineral oil	oil resistant according to IEC 60811-2-1 (4 hours / 70°C)	oil resistant according to IEC 60811-2-1 (7x24h/90°C)	oil resistant according to IEC 60811-2-1 (7x24h/90°C)	oil resistant according to IEC 60811-2-1 (7x24h/90°C)
• to grease	Conditional resistance	Resistant	Resistant	Resistant
• to water	Conditional resistance	Conditional resistance	Conditional resistance	Conditional resistance
Radiological resistance to UV radiation	Resistant	Resistant	Resistant	Resistant
Product properties, functions, components general				
Product feature				
• halogen-free	No	Yes	No	No
• silicon-free	Yes	Yes	Yes	Yes
Standards, specifications, approvals				
UL/ETL listing with 300 V rating	No	Yes: c(UL)us, CMX	Yes: c(UL)us, CMX	Yes: CMX
UL/ETL style with 600 V rating	No	No	No	No
Verification of suitability				
• CE mark	Yes	Yes	Yes	Yes
• RoHS conformity	Yes	Yes	Yes	Yes
Marine classification association				
• Germanische Lloyd (GL)	No	No	No	No
• Lloyds Register of Shipping (LRS)	No	No	No	No

Technical specifications (continued)

Article No.	6XV1830-0LH10	6XV1830-3GH10	6XV1830-0PH10	6XV1830-0MH10
Product-type designation	PROFIBUS FC FRNC Cable GP	PROFIBUS Festoon Cable GP	PROFIBUS Torsion Cable	SIENOPYR FR Marine Cable
Product description	Highly flamed retardant, halogen-free bus cable (2-core), sold by the meter, in bulk	Flexible bus cable (2-core), sold by the meter, in bulk	Highly flexible bus cable (2-core), sold by the meter, in bulk	Bus cable (2-core), sold by the meter, in bulk
Acceptability for application	Halogen-free cable, suitable for use in buildings	Specially for festoon attachment	For use in moving machine components	
Cable designation	02YSH (ST) CH 1x2x0.64/2.55-150 VI KF 25 FRNC FC	02YS (ST) CY 1x2x0.65/2.56 LI petrol FR	02Y (ST) C 11Y 1x2x0.8/2.56-150 LI FR VI	M-02Y (ST) CH X 1 x 2 x 0.35 100 V
Electrical data				
Damping ratio per length				
• at 9.6 kHz maximum	2.5 dB/km	3 dB/km	2.5 dB/km	3 dB/km
• at 38.4 kHz maximum	4 dB/km	4 dB/km	3 dB/km	5 dB/km
• at 4 MHz maximum	22 dB/km	25 dB/km	25 dB/km	22 dB/km
• at 16 MHz maximum	42 dB/km	49 dB/km	49 dB/km	45 dB/km
Impedance				
• Nominal value	150 Ω	150 Ω	150 Ω	150 Ω
• at 9.6 kHz	270 Ω	270 Ω	270 Ω	250 Ω
• at 38.4 kHz	185 Ω	185 Ω	185 Ω	185 Ω
• for frequency range 3 MHz ... 20 MHz	150 Ω	150 Ω	150 Ω	150 Ω
Relative symmetrical tolerance				
• of the surge impedance at 9.6 kHz	10 %	10 %	10 %	10 %
• of the surge impedance at 38.4 kHz	10 %	10 %	10 %	10 %
• of the surge impedance at 3 MHz ... 20 MHz	10 %	10 %	10 %	10 %
Loop resistance per length maximum	110 Ω/km	133 Ω/km	98 Ω/km	110 Ω/km
Shield resistance per length maximum	9.5 Ω/km	19 Ω/km	14 Ω/km	-
Capacity per length at 1 kHz	28.5 pF/m	28 pF/m	29 pF/m	-
Operating voltage RMS value	100 V	100 V	100 V	100 V
Mechanical data				
Number of electrical wires	2	2	2	2
Design of shield	Overlapped aluminum-clad foil, sheathed in a braided screen of tin-plated copper wires	Overlapped aluminum-clad foil, sheathed in a braided screen of tin-plated copper wires	Overlapped aluminum-clad foil, sheathed in a braided screen of tin-plated copper wires	Overlapped aluminum-clad foil, sheathed in a braided screen of tin-plated copper wires
Design of the electrical connection FastConnect	Yes	No	No	No
Outer diameter				
• of the inner conductor	0.65 mm	0.67 mm	0.8 mm	0.67 mm
• of the wire insulation	2.55 mm	2.56 mm	2.56 mm	-
• of the inner sheath of the cable	5.4 mm	5.8 mm	6 mm	8 mm
• of the cable sheath	8 mm	8 mm	8 mm	9.8 mm
Symmetrical tolerance of outer diameter of cable sheath	0.4 mm	0.3 mm	0.4 mm	0.5 mm
Outer diameter of the cable sheath Note	-	-	-	Outer diameter > 8 mm: Bus connectors can only be connected after the outer sheath has been stripped
Material				
• of the wire insulation	PE	PE	PE	PE
• of the inner sheath of the cable	FRNC	-	-	Halogen-free polymer (HM4)
• of the cable sheath	FRNC	PVC	-	Halogen-free, cross-linked polymer
Color				
• of the insulation of data wires	red / green	red / green	red / green	red / green
• of the cable sheath	Violet	Petrol	Violet	Black
Bending radius				
• with single bend minimum permissible	60 mm	30 mm	30 mm	98 mm
• with multiple bends minimum permissible	80 mm	70 mm	60 mm	196 mm
• with continuous bending	-	70 mm	60 mm	-
• Note	-	-	Not suitable for installation in festoons	-

PROFIBUS

Electrical networks (RS 485)

PROFIBUS bus cables

Technical specifications (continued)

Article No.	6XV1830-0LH10	6XV1830-3GH10	6XV1830-0PH10	6XV1830-0MH10
Product-type designation	PROFIBUS FC FRNC Cable GP	PROFIBUS Festoon Cable GP	PROFIBUS Torsion Cable	SIENOPYR FR Marine Cable
Number of torsion cycles with torsion by $\pm 180^\circ$ on 1 m cable length	-	-	5 000 000	-
Traction stress maximum	100 N	80 N	100 N	100 N
Weight per length	72 kg/km	64 kg/km	65 kg/km	110 kg/km
Permitted ambient conditions				
Ambient temperature				
• during operating	-25 ... +80 °C	-40 ... +80 °C	-25 ... +75 °C	-35 ... +80 °C
• during storage	-25 ... +80 °C	-40 ... +80 °C	-40 ... +80 °C	-35 ... +80 °C
• during transport	-25 ... +80 °C	-40 ... +80 °C	-40 ... +80 °C	-35 ... +80 °C
• during installation	-25 ... +80 °C	-40 ... +80 °C	-25 ... +75 °C	-15 ... +80 °C
Ambient condition for (standard) operation mode	-	-	-	At ambient temperatures below -15 degrees Celsius, the cable must not be subjected to any movements other than the normal vibration levels encountered on board ship
Burning behaviour	flame resistant according to IEC 60332-3-24 (Category C), IEC 60332-3-22 (Category A), EN 50267-2-1/2, IEC 61034	flame resistant according to IEC 60332-3-24 (Category C)	flame resistant according to IEC 60332-1-2	flame resistant according to IEC 60332-3-24, IEC 607542, IEC 61031
Chemical resistance				
• to mineral oil	oil resistant according to IEC 60811-2-1 (4 h / 70°C)	Conditional resistance	oil resistant according to IEC 60811-2-1 (7x24h/90°C)	Resistant to diesel fuel according to DIN VDE 51601, ASTM oil No. 2 according to DIN 53521, oil, NATOCode 0178, BWTL 91500031/2 according to VG 95214 Part 4, hydraulic fluid, NATOCode H515, BWTL 91500020 according to VG 95214 Part 4, cold cleaning solvent, BW-TL 68500017 according to VG 95214 Part 4, deionized water according to VG 95214 Part 4, deionized water with 3.5% NaCl
• to grease	Conditional resistance	Conditional resistance	Resistant	Resistant
• to water	Conditional resistance	Conditional resistance	Conditional resistance	Conditional resistance
Radiological resistance to UV radiation	Resistant	Resistant	Resistant	Resistant
Product properties, functions, components general				
Product feature				
• halogen-free	Yes	No	Yes	Yes
• silicon-free	Yes	Yes	Yes	Yes
Standards, specifications, approvals				
UL/ETL listing with 300 V rating	Yes: c(UL)us, CM / CL3 / Sun Res	Yes: CMG / PLCT / Sun Res / Oil Res	Yes: CMX	No
UL/ETL style with 600 V rating	Yes	Yes	No	No
Verification of suitability				
• CE mark	Yes	Yes	Yes	-
• RoHS conformity	Yes	-	Yes	-
Marine classification association				
• Germanische Lloyd (GL)	No	No	No	Yes
• Lloyds Register of Shipping (LRS)	No	No	No	Yes

Technical specifications (continued)

Article No.	6XV1860-2R	6XV1860-2S
Product-type designation	PROFIBUS Hybrid Standard Cable GP	PROFIBUS Hybrid Robust Cable
Product description	Hybrid cable (data and power cores), sold by the meter, in bulk	Hybrid cable (data and power cores), sold by the meter, in bulk
Acceptability for application	Trailing-type, hybrid cable used for supplying data and power to ET 200pro	Rugged cable for supplying data and power to ET 200pro under conditions of high mechanical loading. Cable resistance to weld spatter according to HD22.2 S3 / 5
Cable designation	02Y(ST)C 1x2x0.65/2.56-150LI LIY-Z Y 2x1x1.5 VI	02Y(ST)C 1x2x0.65/2.56-150LI LIH-Z 11Y 2x1x1.5 VI FRNC
Electrical data		
Damping ratio per length		
• at 9.6 kHz maximum	4 dB/km	4 dB/km
• at 38.4 kHz maximum	4 dB/km	4 dB/km
• at 4 MHz maximum	25 dB/km	25 dB/km
• at 16 MHz maximum	49 dB/km	49 dB/km
Impedance		
• Nominal value	150 Ω	150 Ω
• at 9.6 kHz	270 Ω	270 Ω
• at 38.4 kHz	185 Ω	185 Ω
• for frequency range 3 MHz ... 20 MHz	150 Ω	150 Ω
Relative symmetrical tolerance		
• of the surge impedance at 9.6 kHz	10 %	10 %
• of the surge impedance at 38.4 kHz	10 %	10 %
• of the surge impedance at 3 MHz ... 20 MHz	10 %	10 %
Loop resistance per length maximum	138 Ω/km	138 Ω/km
Shield resistance per length maximum	10 Ω/km	10 Ω/km
Capacity per length at 1 kHz	30 pF/m	30 pF/m
Operating voltage RMS value	300 V	300 V
Conductor cross section of the power wires	1.5 mm ²	1.5 mm ²
Continuous current of the power wires	7.5 A	7.5 A
Mechanical data		
Design of shield	Overlapped aluminum-clad foil, sheathed in a braided screen of tin-plated copper wires	Overlapped aluminum-clad foil, sheathed in a braided screen of tin-plated copper wires
Number of electrical wires	4	4
Design of the electrical connection FastConnect	No	No
Outer diameter		
• of the wire insulation	2.56 mm	2.56 mm
• of the cable sheath	11 mm	11 mm
Symmetrical tolerance of outer diameter of cable sheath	0.5 mm	0.5 mm
Material		
• of the wire insulation	PE	PE
Material	PVC	PUR
Color		
• of the insulation of data wires	red / green	red / green
• of the power wire insulation	Black	Black
• of the cable sheath	Violet	Violet
Bending radius Bending radius		
• with single bend minimum permissible	44 mm	44 mm
• with multiple bends minimum permissible	125 mm	125 mm
Number of bending cycles	1 000 000	3 000 000
• Note	For use in cable carriers, for 1 million bending cycles with a bending radius of 125 mm and an acceleration of 2.5 m/s ²	For use in cable carriers, for 3 million bending cycles with a bending radius of 125 mm and an acceleration of 2.5 m/s ²
Traction stress maximum	450 N	450 N
Weight per length	140 kg/km	135 kg/km

PROFIBUS

Electrical networks (RS 485)

PROFIBUS bus cables

Technical specifications (continued)

Article No.	6XV1860-2R	6XV1860-2S
Product-type designation	PROFIBUS Hybrid Standard Cable GP	PROFIBUS Hybrid Robust Cable
Permitted ambient conditions		
Ambient temperature		
• during operating	-40 ... +75 °C	-40 ... +75 °C
• during storage	-40 ... +75 °C	-40 ... +75 °C
• during transport	-40 ... +75 °C	-40 ... +75 °C
• during installation	-40 ... +75 °C	-40 ... +75 °C
Burning behaviour	flame resistant according to IEC 60332-1-2	flame resistant according to IEC 60332-1-2
Chemical resistance		
• to mineral oil	Conditional resistance	Resistant
• to grease	Conditional resistance	Resistant
Radiological resistance to UV radiation	not resistant	resistant
Product properties, functions, components general		
Product feature		
• halogen-free	No	Yes
• silicon-free	Yes	Yes
Standards, specifications, approvals		
UL/ETL listing with 300 V rating	Yes: CMG	Yes: CMX
UL/ETL style with 600 V rating	No	No
Verification of suitability		
• RoHS conformity	Yes	Yes

Ordering data	Article No.	Article No.	
PROFIBUS FC Standard Cable GP Standard type with special design for fast mounting, 2-core, shielded, Sold by the meter; max. length 1 000 m, minimum order 20 m <u>Not pre-assembled</u> <ul style="list-style-type: none"> • 20 m • 50 m • 100 m • 200 m • 500 m • 1 000 m <u>In spool box</u> <ul style="list-style-type: none"> • 50 m • 100 m 	6XV1830-0EH10 6XV1830-0EN20 6XV1830-0EN50 6XV1830-0ET10 6XV1830-0ET20 6XV1830-0ET50 6XV1830-0EU10 6XV1830-1EN50 6XV1830-1ET10	PROFIBUS Torsion Cable 2-core, shielded Sold by the meter; max. length 1 000 m, minimum order 20 m PROFIBUS Hybrid Standard Cable GP PROFIBUS hybrid cable suitable as trailing cable and resistant to welding spatter, with 2 power conductors (1.5 mm ²) for supply of data and power to ET 200pro PROFIBUS Hybrid Robust Cable Rugged PROFIBUS hybrid cable suitable as trailing cable and resistant to welding spatter, with 2 power conductors (1.5 mm ²) for supply of data and power to ET 200pro	6XV1830-0PH10 6XV1860-2R 6XV1860-2S
PROFIBUS FC Standard Cable IS GP Standard type with special design for quick assembly, 2-core, shielded, for intrinsically safe distributed I/O systems Sold by the meter; max. length 1 000 m, minimum order 20 m	6XV1831-2A	SIENOPYR PROFIBUS shipboard cable Copper cable for ships and offshore units Sold by the meter; max. length 1 000 m, minimum order 20 m	6XV1830-0MH10
PROFIBUS FC Robust Cable 2-core, shielded Sold by the meter; max. length 1 000 m, minimum order 20 m	6XV1830-0JH10	Additional components PROFIBUS FastConnect Stripping Tool Preadjusted stripping tool for fast stripping of PROFIBUS FastConnect bus cables	6GK1905-6AA00
PROFIBUS FC Food Cable 2-core, shielded Sold by the meter; max. length 1 000 m, minimum order 20 m	6XV1830-0GH10	PROFIBUS FastConnect Blade Cassettes Spare blade cassettes for PROFIBUS FastConnect stripping tool, 5 units	6GK1905-6AB00
PROFIBUS FC Ground Cable 2-core, shielded Sold by the meter; max. length 1 000 m, minimum order 20 m	6XV1830-3FH10	PROFIBUS FastConnect bus connector RS485 with 90° cable outlet With insulation displacement terminals, max. transfer rate 12 Mbit/s <ul style="list-style-type: none"> • Without PG interface • With PG interface 	6ES7972-0BA52-0XA0 6ES7972-0BB52-0XA0
PROFIBUS FC Flexible Cable 2-core, shielded Sold by the meter; max. length 1 000 m, minimum order 20 m	6XV1831-2K	PROFIBUS FastConnect bus connector RS485 Plug 180 With 180° cable outlet, insulation displacement	6GK1500-0FC10
PROFIBUS FC Trailing Cable 2-core, shielded Sold by the meter; max. length 1 000 m, minimum order 20 m <ul style="list-style-type: none"> • Sheath color: Petrol • Sheath color: Violet 	6XV1830-3EH10 6XV1831-2L	Accessories Lightning protection modules for reliable transmission between buildings with overvoltage protection¹⁾ Basic protection <ul style="list-style-type: none"> • Basic section • Protection module Type B • Protective housing • Terminal element Low-voltage protection <ul style="list-style-type: none"> • Basic section • Protection module • Terminal element 	919506 919510 906055 919508 919506 919570 919508
PROFIBUS Festoon Cable GP 2-core, shielded Sold by the meter; max. length 1 000 m, minimum order 20 m	6XV1830-3GH10	SIMATIC NET Manual Collection Electronic manuals for communication systems, communication protocols, and communication products; on DVD; German/English	6GK1975-1AA00-3AA0
PROFIBUS FC FRNC Cable GP 2-core, shielded, nonflammable, with copolymer outer sheath FRNC Sold by the meter; max. length 1 000 m, minimum order 20 m	6XV1830-0LH10		

¹⁾ Order from:
 DEHN & Söhne
 Hans-Dehn-Str.1
 92318 Neumarkt/Opf, Germany

PROFIBUS

Electrical networks (RS 485)

PROFIBUS bus cables

More information

Installation instructions

The bus cables are supplied by the meter. If a bus segment must be assembled using two sections (e.g. > 1 000 m segment length), bushings can be used for this purpose (low-impedance connection between cores with clamps, connect shields over a wide area).

FastConnect

The FastConnect stripping tool can be used to strip the outer sheath and shield of the new FastConnect bus cables to the right length in one step.

In this way, the bus connectors (except 6ES7972-0BA30-0XA0) can be connected easily and quickly to the bus cable.

Migration in discrete automation

For many years, PROFIBUS has been the established fieldbus for machines and plants and with the wider use of Ethernet in IT and PROFINET in industry, production systems today would be unimaginable without either of these systems.

For migration from PROFIBUS to PROFINET or Industrial Ethernet in discrete automation, Siemens offers a solution in which the existing two-wire cabling for Ethernet communication can be used.

For further information on this, please refer to Section 2 and the Internet at: www.siemens.com/vd

Cable routing:

During storage, transport and cable laying, keep both ends sealed with a shrink-on cap.

Comply with the permissible bending radii and tensile load!

An underground cable must be used if cables are laid outside buildings e.g. directly in the ground, in sand or in concrete building blocks or when routed through protective pipes made of steel or plastic above or below ground.

Comply with overvoltage protection guidelines for underground laying.

Note:

You can order components supplementary to the SIMATIC NET cabling range from your local contact.

Technical advice on this subject is available from:

J. Hertlein
 I IA SC CI PRM 4
 Phone: 0911/750 44 65
 E-mail: juergen.hertlein@siemens.com

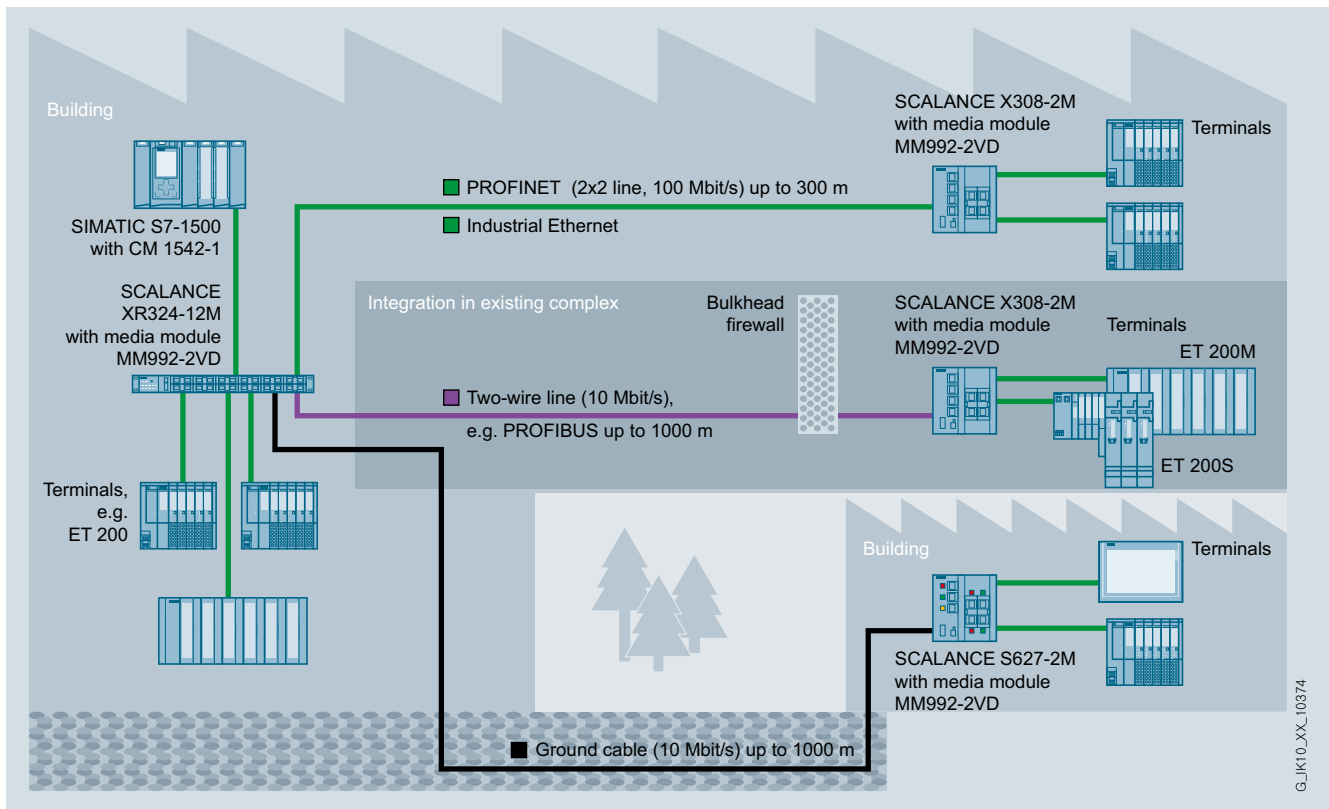

Overview

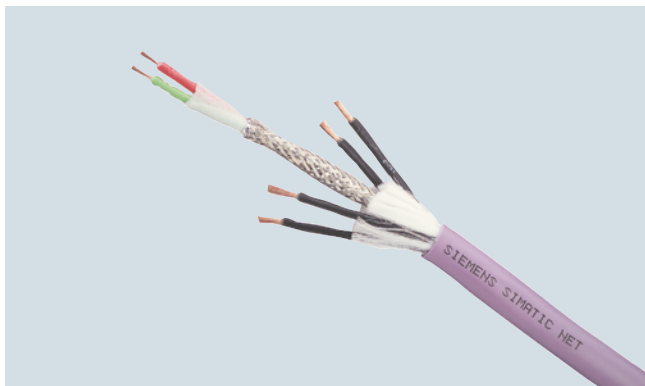

In the ECOFAST system, all devices with bus capability are connected to PROFIBUS DP using the bus cables.

The bus cable is implemented as a hybrid cable and contains:

- PROFIBUS DP in copper RS 485;
- Four additional copper cores for carrying 24 V DC:
 - 24 V DC, not switched (for electronics and inputs)
 - 24 V DC, switched (for outputs, disconnectable e.g. for EMERGENCY OFF)

The ECOFAST hybrid cables are sold by the meter or in fixed lengths preassembled with ECOFAST connector (Han Brid) and socket.

Benefits

- Savings in wiring, installation, commissioning and operation as result of standardized connection system (copper or fiber-optic) with high degree of protection (IP65)
- With ECOFAST, the turnaround times for offers, planning and engineering of machines and plants can be reduced
- ECOFAST permits fast and problem-free startup of automation and drive systems
- Minimization of sources of error by means of standardized interfaces and plug connectors.
- With ECOFAST plants remain highly available: No interruption of power and fieldbus when replacing equipment.

Technical specifications

Article No.	6XV1830-7AH10	6XV1860-2P
Product-type designation	PROFIBUS ECOFAST Hybrid Cable	PROFIBUS ECOFAST Hybrid Cable GP
Product description	ECOFAST hybrid cable (data and power cores), sold by the meter, in bulk	ECOFAST hybrid cable (data and power cores), sold by the meter, in bulk
Acceptability for application	Hybrid cable for connection of ECOFAST stations	Hybrid cable for connection of ECOFAST stations, UL approval
Cable designation	02Y (ST) C 1 x 2 x 0.65/2.56 - 150 LI LIH-Z 11Y 4 x 1 x 1.5 VI FRNC	02Y (ST)C 1x2x0.65/2.56 - 150 LI LIY-Z Y 4x1x1.5 VI
Electrical data		
Damping ratio per length		
• at 9.6 kHz maximum	0.004 dB/m	0.004 dB/m
• at 38.4 kHz maximum	0.004 dB/m	0.004 dB/m
• at 4 MHz maximum	0.025 dB/m	0.025 dB/m
• at 16 MHz maximum	0.049 dB/m	0.049 dB/m
Impedance		
• Nominal value	150 Ω	150 Ω
• at 9.6 kHz	270 Ω	270 Ω
• at 38.4 kHz	185 Ω	185 Ω
• for frequency range 3 MHz ... 20 MHz	150 Ω	150 Ω
Relative symmetrical tolerance		
• of the surge impedance at 9.6 kHz	10 %	10 %
• of the surge impedance at 38.4 kHz	10 %	10 %
• of the surge impedance at 3 MHz ... 20 MHz	10 %	10 %
Loop resistance per length maximum	138 Ω/km	138 Ω/km
Shield resistance per length maximum	15 Ω/km	15 Ω/km
Capacity per length at 1 kHz	30 pF/m	30 pF/m
Inductance per length	-	-
Operating voltage RMS value	100 V	600 V
Conductor cross section of the power wires	1.5 mm ²	1.5 mm ²
Continuous current of the power wires	12 A	12 A

PROFIBUS

Electrical networks (RS485)

ECOFAS^T bus cables

Technical specifications (continued)

Article No.	6XV1830-7AH10	6XV1860-2P
Product-type designation	PROFIBUS ECOFAST Hybrid Cable	PROFIBUS ECOFAST Hybrid Cable GP
Mechanical data		
Design of shield	Overlapped aluminum-clad foil, sheathed in a braided screen of tin-plated copper wires	Overlapped aluminum-clad foil, sheathed in a braided screen of tin-plated copper wires
Number of electrical wires	6	6
Design of the electrical connection FastConnect	No	No
Outer diameter		
• of the wire insulation	2.56 mm	2.56 mm
• of the cable sheath	11 mm	11 mm
Symmetrical tolerance of outer diameter of cable sheath	0.3 mm	0.3 mm
Material		
• of the wire insulation	PE	PE
• of the cable sheath	PUR	PVC
Color		
• of the insulation of data wires	red / green	red / green
• of the power wire insulation	Black	Black
• of the cable sheath	Violet	Violet
Bending radius		
• with multiple bends minimum permissible	82.5 mm	110 mm
Number of bending cycles	5 000 000	1 000 000
• Note	For use in cable carriers, for 5 million bending cycles with a bending radius of 82.5 mm (7.5x D) and an acceleration of 2.5 m/s ²	For use in cable carriers, for 1 million bending cycles with a bending radius of 166 mm (15x D) and an acceleration of 4.0 m/s ²
Traction stress maximum	300 N	300 N
Weight per length	150 kg/km	154 kg/km
Permitted ambient conditions		
Ambient temperature		
• during operating	-40 ... +60 °C	-30 ... +80 °C
• during storage	-40 ... +60 °C	-30 ... +80 °C
• during transport	-40 ... +60 °C	-30 ... +80 °C
• during installation	-40 ... +60 °C	-30 ... +80 °C
Burning behaviour		
Chemical resistance		
• to mineral oil	Conditional resistance	Conditional resistance
• to grease	Conditional resistance	Conditional resistance
Radiological resistance to UV radiation	resistant	resistant
Product properties, functions, components general		
Product feature		
• halogen-free	Yes	Yes
• silicon-free	Yes	Yes
Standards, specifications, approvals		
UL/ETL listing with 300 V rating	No	No
UL/ETL style with 600 V rating	No	Yes: CM / CL3 / SunRes / OilRes
Verification of suitability		
• RoHS conformity	Yes	Yes

Technical specifications (continued)

Article No.	6GK1905-0CA00	6GK1905-0CB00	6GK1905-0CC00	6GK1905-0CD00
Product-type designation	PB ECOFAST Hybrid Plug 180	PB ECOFAST Hybrid Plug 180	PB ECOFAST Hybrid Plug angled	PB ECOFAST Hybrid Plug angled
Product description	ECOFAST Hanbrid connector with pin insert	ECOFAST Hanbrid connector with socket insert	ECOFAST Hanbrid connector with pin insert, angled	ECOFAST Hanbrid connector with socket insert, angled
Acceptability for application	For connection to ECOFAST hybrid cables, transmission of data and power	For connection to ECOFAST hybrid cables, transmission of data and power	For connection to ECOFAST hybrid cables, transmission of data and power	For connection to ECOFAST hybrid cables, transmission of data and power
Transmission rate				
Transfer rate with PROFIBUS	9.6 kbit/s ... 12 Mbit/s	9.6 kbit/s ... 12 Mbit/s	9.6 kbit/s ... 12 Mbit/s	9.6 kbit/s ... 12 Mbit/s
Interfaces				
Number of electrical connections				
• for PROFIBUS cables	1	1	1	1
• for network components and terminal equipment	1	1	1	1
Design of electrical connection				
• for PROFIBUS cables	Integrated crimp contacts for 6-core ECOFAST hybrid cables	Integrated crimp contacts for 6-core ECOFAST hybrid cables	Integrated crimp contacts for 6-core ECOFAST hybrid cables	Integrated crimp contacts for 6-core ECOFAST hybrid cables
• for network components and terminal equipment	Hanbrid connector with male insert	Hanbrid connector with female insert	Hanbrid connector with male insert	Hanbrid connector with female insert
Mechanical data				
Material of the enclosure	plastic	plastic	plastic	plastic
Design, dimensions and weight				
Type of cable outlet	180 degree cable outlet	180 degree cable outlet	90 degree cable outlet	90 degree cable outlet
Width	27 mm	27 mm	27 mm	27 mm
Height	27 mm	27 mm	27 mm	27 mm
Depth	71 mm	71 mm	71 mm	71 mm
Net weight	40 g	40 g	40 g	40 g
Permitted ambient conditions				
Ambient temperature				
• during operating	-20 ... +70 °C	-20 ... +70 °C	-20 ... +70 °C	-20 ... +70 °C
• during storage	-40 ... +80 °C	-40 ... +80 °C	-40 ... +80 °C	-40 ... +80 °C
• during transport	-40 ... +80 °C	-40 ... +80 °C	-40 ... +80 °C	-40 ... +80 °C
Protection class IP	IP65/67	IP65/67	IP65/67	IP65/67
Chemical resistance to water	resistant	resistant	resistant	resistant
Product properties, functions, components general				
Product feature silicon-free	Yes	Yes	Yes	Yes
Product component strain relief	Yes	Yes	Yes	Yes
Standards, specifications, approvals				
Verification of suitability RoHS conformity	Yes	Yes	Yes	Yes

PROFIBUS

Electrical networks (RS485)

ECOFAST bus cables

Technical specifications (continued)

Article No.	6GK1905-0DA10
Product-type designation	PB ECOFAST Terminating Plug
Product description	ECOFAST bus terminating plug connector with pin insert and integral terminating resistors
Acceptability for application	As terminating plug-in connector for PROFIBUS DP
Transmission rate	
Transfer rate with PROFIBUS	9.6 kbit/s ... 12 Mbit/s
Interfaces	
Number of electrical connections	
• for PROFIBUS cables	-
• for network components and terminal equipment	1
Design of electrical connection	
• for PROFIBUS cables	-
• for network components and terminal equipment	Hanbrid connector with female insert
Number of optical interfaces for optical waveguide	-
Design of optical connections for network components or terminal devices	-
Mechanical data	
Design of terminating resistor	Integrated resistor combination
Material of the enclosure	plastic

Article No.	6GK1905-0DA10
Product-type designation	PB ECOFAST Terminating Plug
Design, dimensions and weight	
Type of cable outlet	180 degree cable outlet
Width	27 mm
Height	27 mm
Depth	71 mm
Net weight	40 g
Permitted ambient conditions	
Ambient temperature	
• during operating	-20 ... +70 °C
• during storage	-40 ... +80 °C
• during transport	-40 ... +80 °C
Relative humidity at 25 °C without condensation during operating maximum	-
Protection class IP	IP65/67
Chemical resistance to water	resistant
Product properties, functions, components general	
Product feature silicon-free	Yes
Product component strain relief	Yes
Standards, specifications, approvals	
Verification of suitability RoHS conformity	Yes

Ordering data	Article No.	Article No.
PROFIBUS ECOFAST Hybrid Cable - Cu Trailing cable (PUR sheath), with two shielded Cu wires for PROFIBUS DP plus four Cu wires of 1.5 mm ² Sold by the meter; max. length 1 000 m; minimum order 20 m Pre-assembled with ECOFAST male and female connectors, fixed length <ul style="list-style-type: none"> • 0.5 m • 1.0 m • 1.5 m • 3 m • 5 m • 10 m • 15 m • 20 m Pre-assembled with two ECOFAST connectors, variable length	6XV1830-7AH10 6XV1830-7BH05 6XV1830-7BH10 6XV1830-7BH15 6XV1830-7BH30 6XV1830-7BH50 6XV1830-7BN10 6XV1830-7BN15 6XV1830-7BN20	Additional components PROFIBUS Cu bus connector with 2 x Cu shielded and 4 x Cu 1.5 mm ² ; type of contact: POF, Han D for 24 V; tool: crimping tool, polishing set; 5 units; with assembly instructions <ul style="list-style-type: none"> • with pin insert • with socket insert PROFIBUS ECOFAST Hybrid Plug angled; with 2 x Cu shielded and 4 x Cu 1.5 mm ² ; 5 units; with installation instructions <ul style="list-style-type: none"> • Male pins • Female pins; ECOFAST Terminating Plug Bus termination plug-in connector for PROFIBUS DP; with 2 x Cu and 4 x Cu 1.5 mm ² ; male pins, integrated termination resistors <ul style="list-style-type: none"> • Pack of 1 • Pack of 5 Data T piece For 2 x 24 V auxiliary voltage (switched and non-switched) and PROFIBUS DP <ul style="list-style-type: none"> • for Cu RS485 • for fiber-optic cable Addressing plug For setting the PROFIBUS DP addresses
PROFIBUS ECOFAST Hybrid Cable GP Trailing cable with 4 x Cu and 2 x Cu, shielded, with UL approval Sold by the meter; max. quantity 1 000 m; minimum order 20 m; Pre-assembled with ECOFAST male and female connectors <ul style="list-style-type: none"> • 0.5 m • 1 m • 1.5 m • 3 m • 5 m • 10 m • 15 m • 20 m 	6XV1860-2P 6XV1860-3PH05 6XV1860-3PH10 6XV1860-3PH15 6XV1860-3PH30 6XV1860-3PH50 6XV1860-3PN10 6XV1860-3PN15 6XV1860-3PN20	6GK1905-0CA00 6GK1905-0CB00 6GK1905-0CC00 6GK1905-0CD00 6GK1905-0DA10 6GK1905-0DA00 3RK1911-2AG00 3RK1911-2AH00 6ES7194-1KB00-0XA0

More information

You can order components supplementary to the SIMATIC NET cabling range from your local contact.

Technical advice on this subject is available from:

J. Hertlein
 I IA SC CI PRM 4
 Phone: +49 (911) 750-4465
 E-mail: juergen.hertlein@siemens.com

PROFIBUS

Electrical networks (RS485)

Hybrid fieldbus connections

Overview



Hybrid fieldbus connection with two HanBrid sockets



Control cabinet bushing with two M12 sockets

Hybrid fieldbus connections with HanBrid sockets designed as cabinet bushings transmit data and energy from the control cabinet (IP20) to the field (IP65). They are the interface for jointly routing PROFIBUS DP and the auxiliary voltages into the hybrid fieldbus cable.

On the cabinet bushings with two M12 sockets for the PROFIBUS M12 connecting cables, the 24 V supply of the motor starters is implemented via separate 7/8" connecting cables.

Passive and active hybrid fieldbus connections

The hybrid fieldbus connections are available in two versions which differ in their functionality. These are:

- The passive version
- The active version with signal refresher function to considerably increase the maximum PROFIBUS cable length

Connection methods

The field side is connected using HanBrid or M12 plug-in connectors.

In the case of HanBrid, the following versions are available:

- Socket/socket for infeeding into the field
- Pin/socket for looping in the field

The M12 version is generally configured with socket/socket.

Following connections are available at the rear (cabinet side) in the case of the passive glands:

- Direct connection
- Fast Connect connection

The active gland with refresher function has 9-pole Sub-D sockets for the rear connection.

Auxiliary power infeed

The HanBrid plug-in design offers the possibility of infeeding or looping through not only the Profibus signal but also 2 separate auxiliary voltages of 24 V DC (switched/unswitched) into the field. The terminal block with spring-type terminals at the rear (cabinet side) of the hybrid fieldbus connection provides a variety of interconnecting operations for these auxiliary voltages.

Passive hybrid fieldbus connections

- Gland from the control cabinet (IP20) into the field (IP65)
- HanBrid plug-in design socket/socket or pin/socket
- Direct connection or Fast-Connect connection for PROFIBUS at the rear
- Terminal block with spring-type terminals (0.25 ... 2.5 mm²) for infeeding or looping through the auxiliary voltages

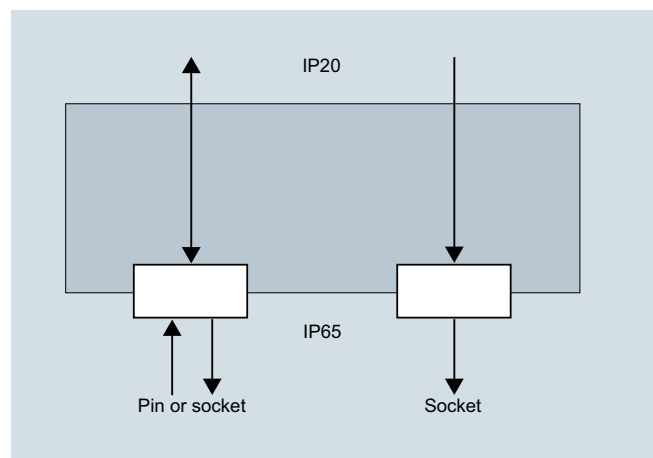

Hybrid fieldbus connection as passive cabinet bushing

Overview (continued)

Active hybrid fieldbus connections with refresher function

- Gland from the control cabinet (IP20) into the field (IP65)
- 3 independent, electrically separated Profibus segments
- Signal refresher function from and to all segments
- Automatic continuous baud rate detection
- Status/diagnostics displays with LEDs
- Cascading depth of a maximum 9 hybrid fieldbus connections
- HanBrid plug-in design socket/socket and pin/socket
- M12 plug-in design socket/socket
- 9-pole Sub D socket connection for PROFIBUS at the rear
- Terminal block with spring-type terminals (0.25 ... 2.5 mm²) for infeeding or looping through the auxiliary voltages

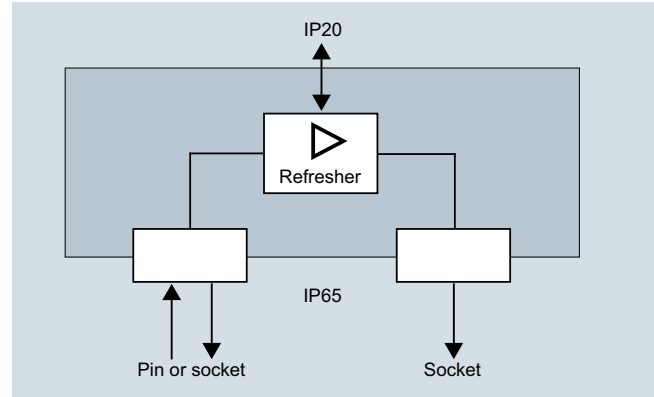

Hybrid fieldbus connection as active control cabinet bushing with refresher function

Selection and ordering data



Hybrid fieldbus connection on the field side:
With socket/socket (HanBrid)



With pin/socket (HanBrid)



Control cabinet bushing on the field side:
With socket/socket (M12)

Link type / function	Connection IP65	Connection IP20 (PROFIBUS)	Article No.
----------------------	-----------------	----------------------------	-------------

Hybrid fieldbus connections

Passive

• Cu/Cu, for feeding into the field	Socket/socket (2 x HanBrid)	Direct connection	3RK1911-1AA22 3RK1911-1AA32 3RK1911-1AF22
• Cu/Cu, for looping through in the field	Pin/socket (2 x HanBrid)	Direct connection	
• Cu/Cu, for feeding into the field	Socket/socket (2 x HanBrid)	PROFIBUS Fast Connect bus connector	
• Cu/Cu, for looping through in the field	Pin/socket (2 x HanBrid)	PROFIBUS Fast Connect bus connector	3RK1911-1AF32

Active (refresher)

• Cu/Cu, for feeding into the field	Socket/socket (2 x HanBrid)	9-pole Sub-D socket	3RK1911-1AJ22 3RK1911-1AJ32 3RK1911-1AK22
• Cu/Cu, for looping through in the field	Pin/socket (2 x HanBrid)	9-pole Sub-D socket	
• Cu/Cu, for feeding into the field	Socket/socket (2 x M12)	9-pole Sub-D socket	

Version	Article No.
---------	-------------

Accessories



6ES7194-1JB10-0XA0

Sealing caps for HanBrid

Protective cover for bus and power supply connections (pack of 10)

6ES7194-1JB10-0XA0

PROFIBUS

Electrical networks (RS485)

Energy cables

Overview

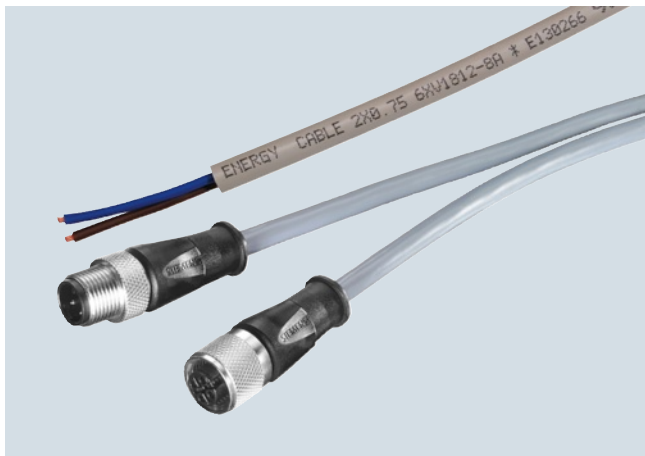

- Different versions (5-core, 2-core) for different fields of application
- Pre-assembled M12 plug-in cables for energy transfer
- Rugged cable design for installation in industrial applications
- UL approvals
- Easy length measurement thanks to printed meter markings

Benefits



- Flexible application possibilities thanks to rugged cable design
- Silicon-free, therefore particularly suitable for use in the automotive industry (e.g. on paint shop conveyors)

Application

Different cable types are needed to supply power to Industrial Ethernet/PROFINET or PROFIBUS. The listed power cables should always be used. They are used for devices with IP65/67 degree of protection to connect the signaling contact or 24-V supply of the SCALANCE X and SCALANCE W components (power cable 2x0.75) and for the power supply (power cable 5x1.5 for ET 200).

In addition, preassembled power connecting cables (4 x 0.75) are available in different lengths for the power supply of the ET 200 (M12 Power Connecting Cable).

UL approvals

As a result of appropriate UL styles, the cables can be used worldwide.

Design

Rugged 2-core, 4-core or 5-core cable with circular cross-section for connection of signaling contact and power supply to IP65/67 components in industrial areas.

Cable types

The following cables with industrial capability are available for connection of the power supply and signaling contact:

- Power cable 2 x 0.75; power cable for connection of signaling contact and 24 V supply voltage to SCALANCE X and SCALANCE W components
- Power cable 5 x 1.5; power cable for connection of 24 V power supply of ET 200 using 7/8" plug connectors
- M12 Power Connecting Cable M12-180/M12-180; 4-core M12 power connecting cables (A-coded) with straight cable outlet for 24 V power supply of the ET 200 (pre-assembled)

Technical specifications

Article No.	6XV1812-8A	6XV1830-8AH10
Product-type designation	Energy Cable 2 x 0,75	Energy Cable 5 x 1,5
Product description	Energy cable (2-core), sold by the meter, in bulk	Energy cable (5-core), sold by the meter, in bulk
Acceptability for application	Connection of signaling contact and 24 V power supply to SCALANCE X and SCALANCE W	Power supply of ET 200 modules with 7/8" power port
Cable designation	L-YY-2x1x0.75 GR	L-Y11Y-Z 5x1x1.5 GR
Electrical data		
Operating voltage RMS value	600 V	600 V
Conductor cross section of the power wires	0.75 mm ²	1.5 mm ²
Continuous current of the power wires	6 A	16 A
Mechanical data		
Number of electrical wires	2	5
Design of the electrical connection FastConnect	-	No
Outer diameter		
• of the inner conductor	1.3 mm	1.55 mm
• of the wire insulation	2.5 mm	2.73 mm
• of the cable sheath	7.4 mm	10.5 mm
Symmetrical tolerance of outer diameter of cable sheath	0.3 mm	0.3 mm
Material		
• of the wire insulation	PVC	PVC
• of the cable sheath	PVC	PUR
Color		
• of the power wire insulation	Brown/blue	4x black, 1x green / yellow
• of the cable sheath	gray	gray
Bending radius		
• with single bend minimum permissible	19 mm	27 mm
• with multiple bends minimum permissible	45 mm	63 mm
• with continuous bending	-	75 mm
Number of bending cycles	-	5 000 000
• Note	-	For use in cable carriers, for 5 million bending cycles with a bending radius of 75 mm, an acceleration of 4 m/s ² and a speed of 180 m/min
Traction stress maximum	100 N	500 N
Weight per length	70 kg/km	149 kg/km
Permitted ambient conditions		
Ambient temperature		
• during operating	-20 ... +80 °C	-40 ... +80 °C
• during storage	-20 ... +80 °C	-40 ... +80 °C
• during transport	-20 ... +80 °C	-40 ... +80 °C
• during installation	-20 ... +80 °C	-40 ... +80 °C
Burning behaviour	flame resistant according to IEC 60332-1-2	flame resistant according to IEC 60332-1-2
Chemical resistance		
• to mineral oil	Conditional resistance	Resistant
• to grease	Conditional resistance	Resistant
• to water	Conditional resistance	Conditional resistance
Radiological resistance to UV radiation	Resistant	Resistant
Product properties, functions, components general		
Product feature		
• halogen-free	No	No
• silicon-free	Yes	Yes
Standards, specifications, approvals		
UL/ETL listing with 300 V rating	Yes: CL3	No
UL/ETL style with 600 V rating	Yes	Yes
Verification of suitability		
• CE mark	Yes	Yes
• RoHS conformity	Yes	Yes

PROFIBUS

Electrical networks (RS485)

Energy cables

Technical specifications (continued)

Article No.	6XV1801-5DH10	Article No.	6XV1801-5DH10
Product-type designation	POWER CONNECTING CABLE M12-180/M12-180	Product-type designation	POWER CONNECTING CABLE M12-180/M12-180
Product description	Flexible connecting cable (4-core), preferred length, preassembled with a 4-pin M12 plug and a 4-pin M12 socket (A-coded)	Permitted ambient conditions	
Acceptability for application	Cable for connecting the 24 V power supply to ET 200eco PN to IP 65/67 degree of protection	Ambient temperature	
Cable designation	LI9YH-Y 4x0.75	• during operating	-25 ... +80 °C
Cable length	1 m	• during storage	-25 ... +80 °C
Electrical data		• during transport	-25 ... +80 °C
Operating voltage RMS value	300 V	• during installation	-5 ... +80 °C
Conductor cross section of the power wires	0.75 mm ²	• Comment	With moving applications, the permissible operating temperature range is -5 to +80 degrees Celsius
Continuous current of the power wires	-	Protection class IP	IP65/67
Mechanical data		Burning behaviour	Flame-retardant in accordance with UL 758 (CSA FT 1)
Number of electrical wires	4	Chemical resistance	
Outer diameter		• to mineral oil	Conditional resistance
• of the inner conductor	1.1 mm	• to grease	Conditional resistance
• of the wire insulation	1.7 mm	• to water	Conditional resistance
• of the cable sheath	5.7 mm	Radiological resistance to UV radiation	Not resistant
Symmetrical tolerance of outer diameter of cable sheath	0.2 mm	Product properties, functions, components general	
Material		Product feature	
• of the wire insulation	PP	• halogen-free	No
• of the cable sheath	PVC	• silicon-free	Yes
Color		Standards, specifications, approvals	
• of the power wire insulation	Brown / white / blue / black gray	Verification of suitability	
• of the cable sheath		• UL-registration	Yes
Bending radius		• RoHS conformity	Yes
• with single bend minimum permissible	57 mm		
• with multiple bends minimum permissible	57 mm		
Traction stress maximum	15 N		
Weight per length	54 kg/km		

Article No.	6GK1905-0FA00	6GK1905-0FB00	6GK1905-0FC00
Product-type designation	7/8-inch connector	7/8-inch connector	7/8-inch Power T-Tap PRO
Product description	7/8" connector with pin insert, 5-pin	7/8" connector with female contact insert, 5-pin	Energy T-piece with two 7/8" female contact inserts and one 7/8" pin insert, each 5-pin
Acceptability for application	For field assembly with ET200	For field assembly with ET200	For power connection and distribution to ET200pro modules
Interfaces			
Number of electrical connections for network components and terminal equipment	1	1	3
Design of electrical connection for network components and terminal equipment	7/8 inch plug (male insert)	7/8 inch plug (female insert)	7/8 inch plug (2 x female insert, 1 x male insert)
Mechanical data			
Material of the enclosure	metal	metal	metal
Design, dimensions and weight			
Type of cable outlet	180 degree cable outlet	180 degree cable outlet	-
Width	27 mm	27 mm	58.5 mm
Height	27 mm	27 mm	73.5 mm
Depth	83 mm	83 mm	26.5 mm
Net weight	50 g	50 g	112 g

Technical specifications (continued)

Article No.	6GK1905-0FA00	6GK1905-0FB00	6GK1905-0FC00
Product-type designation	7/8-inch connector	7/8-inch connector	7/8-inch Power T-Tap PRO
Permitted ambient conditions			
Ambient temperature			
• during operating	-40 ... +70 °C	-40 ... +70 °C	-40 ... +70 °C
• during storage	-40 ... +80 °C	-40 ... +80 °C	-40 ... +80 °C
• during transport	-40 ... +80 °C	-40 ... +80 °C	-40 ... +80 °C
Relative humidity at 25 °C without condensation during operating maximum	-	-	-
Protection class IP	IP65/67	IP65/67	IP65/67
Chemical resistance to water	resistant	resistant	resistant
Product properties, functions, components general			
Product feature silicon-free	Yes	Yes	Yes
Product component strain relief	Yes	Yes	Yes
Standards, specifications, approvals			
Verification of suitability RoHS conformity	Yes	Yes	Yes
Article No.	6GK1908-0DC10-6AA3	6GK1907-0DC10-6AA3	6GK1907-0DB10-6AA3
Product-type designation	Signalling Contact M12 Cable Connector	Power M12 Cable Connector PRO	Power M12 Plug PRO
Product description	M12 connecting socket for signal contact, 5-pin, B-coded	M12 Power connecting socket, 4-pin, A-coded	M12 Power connector, 4-pin, A-coded
Acceptability for application	For connection to SCALANCE X208PRO for signaling contact	For connection to SCALANCE W-700 / X208PRO for 24 V DC voltage supply	For connection to PS791-1PRO power supply for 24 V DC voltage supply
Interfaces			
Number of electrical connections for network components and terminal equipment	1	1	1
Design of electrical connection for network components and terminal equipment	M12 connector (B-coded, 5-pin)	M12 connector (female insert, A-coded, 4-pin)	M12 connector (male insert, A-coded, 4-pin)
Mechanical data			
Material of the enclosure	plastic	plastic	plastic
Design, dimensions and weight			
Type of cable outlet	180 degree cable outlet	180 degree cable outlet	180 degree cable outlet
Width	14 mm	19 mm	19 mm
Height	14 mm	19 mm	19 mm
Depth	59 mm	73 mm	73 mm
Net weight	37 g	40 g	40 g
Permitted ambient conditions			
Ambient temperature			
• during operating	-40 ... +70 °C	-40 ... +70 °C	-40 ... +70 °C
• during storage	-40 ... +80 °C	-40 ... +80 °C	-40 ... +80 °C
• during transport	-40 ... +80 °C	-40 ... +80 °C	-40 ... +80 °C
Protection class IP	IP65/67	IP65/67	IP65/67
Chemical resistance to water	resistant	resistant	resistant
Product properties, functions, components general			
Product feature silicon-free	Yes	Yes	Yes
Product component strain relief	Yes	Yes	Yes
Standards, specifications, approvals			
Verification of suitability RoHS conformity	Yes	Yes	Yes

PROFIBUS**Electrical networks (RS485)****Energy cables**

Ordering data	Article No.
Power cable 2 x 0.75 Power cable with trailing capability with 2 copper cores (0.75 mm ²) for connecting to M12 plug-in connector; <u>sold by the meter</u> ; max. 1 000 m, minimum order quantity 20 m	6XV1812-8A
Power cable 5 x 1.5 Power cable with trailing capability with 5 copper cores (1.5 mm ²) for connecting to 7/8" plug-in connector; <u>sold by the meter</u> ; max. 1 000 m; minimum order quantity 20 m	6XV1830-8AH10
M12 Power Connecting Cable M12-180/M12-180 Flexible 4-core power connecting cable, assembled with A-coded 5-pin M12 connector and A-coded, 5-pin M12 socket to supply the ET 200 with 24 V DC; length: <ul style="list-style-type: none"> • 0.3 m • 0.5 m • 1.0 m • 1.5 m • 2.0 m • 3.0 m • 5.0 m • 10 m • 15 m 	6XV1801-5DE30 6XV1801-5DE50 6XV1801-5DH10 6XV1801-5DH15 6XV1801-5DH20 6XV1801-5DH30 6XV1801-5DH50 6XV1801-5DN10 6XV1801-5DN15
<i>Additional components</i>	
7/8" plug-in connector Plug with axial cable outlet for field assembly for ET 200, 5-core, plastic enclosure, 1 pack = 5 items <ul style="list-style-type: none"> • Male pins • Socket insert 	6GK1905-0FA00 6GK1905-0FB00
7/8" Power T-Tap PRO Power T-piece for ET 200 with two 7/8" socket inserts and one 7/8" pin insert 1 pack = 5 items	6GK1905-0FC00
Signaling Contact M12 Cable Connector PRO Socket for connection of SCALANCE X208PRO for signaling contact; 5-pole, B-coded, with assembly instructions; 3 items	6GK1908-0DC10-6AA3
Power M12 Cable Connector PRO Socket for connection of SCALANCE W-700 for 24 V DC supply voltage; 4-pole, A-coded, with assembly instructions, 3 items	6GK1907-0DC10-6AA3
Power M12 Plug PRO Plug for connection to PS791-1PRO power supply for 24 V DC supply voltage; 4-pole, A-coded, with assembly instructions, 3 items	6GK1907-0DB10-6AA3
SIMATIC NET Manual Collection Electronic manuals for communication systems, communication protocols, and communication products; on DVD, German/English	6GK1975-1AA00-3AA0

More information**Cable routing:**

During storage, transport and cable laying, keep both ends sealed with a shrink-on cap.

Comply with the permissible bending radii and tensile load!

Note:

You can order components supplementary to the SIMATIC NET cabling range from your local contact.

Technical advice on this subject is available from:

J. Hertlein
 I IA SC CI PRM 4
 Phone: +49 (911) 750-4465
 E-mail: juergen.hertlein@siemens.com

Overview



- Used for connecting PROFIBUS nodes to the PROFIBUS bus cable
- Easy installation
- FastConnect plugs ensure extremely short assembly times due to their insulation-displacement technology
- Integrated terminating resistors (not in the case of 6ES7972-0BA30-0XA0)
- Connectors with Sub-D socket permit PG connection without the additional installation of network nodes

Application

The RS485 bus connectors for PROFIBUS are used for connecting a PROFIBUS node or a PROFIBUS network component to the bus cable for PROFIBUS.

Design

Several different versions of the bus connector are available, each optimized for the devices to be connected:

- Bus connector with axial cable outlet (180°), e.g. for PCs and SIMATIC HMI OPs, for transmission rates up to 12 Mbit/s with integrated bus terminating resistor.
- Bus connector with vertical cable outlet (90°);

This connector permits a vertical cable outlet (with or without PG interface) for transmission rates of up to 12 Mbit/s with integral bus terminating resistor. At a transmission rate of 3, 6 or 12 Mbit/s, the SIMATIC S5/S7 plug-in cable is required for the connection between bus connector with PG-interface and programming device.

- Bus connector with 30° cable outlet (low-cost version) without PG interface for transmission rates of up to 1.5 Mbit/s and without integrated bus terminating resistor.
- PROFIBUS FastConnect bus connector RS485 (90° or 180° cable outlet) with transmission rates up to 12 Mbit/s for fast and easy assembly using insulation displacement connection technology (for rigid and flexible wires).

Function

The bus connector is plugged directly into the PROFIBUS interface (9-pin Sub-D socket) of the PROFIBUS station or a PROFIBUS network component.

The incoming and outgoing PROFIBUS cable is connected in the plug using 4 terminals.

By means of an easily accessible switch which is clearly visible from the outside, the line terminator integrated in the bus connector can be connected (not in the case of 6ES7972-0BA30-0XA0). In this process, incoming and outgoing bus cables in the connector are separated (separation function).

This must be done at both ends of a PROFIBUS segment.

PROFIBUS

Electrical networks (RS485)

RS485 bus connector

Technical specifications

Article No.	6ES7972-0BA12-0XA0	6ES7972-0BB12-0XA0	6ES7972-0BA42-0XA0	6ES7972-0BB42-0XA0	6ES7972-0BA30-0XA0
Product-type designation	PROFIBUS bus connector RS 485 without PG interface, 90°	PROFIBUS bus connector RS 485 with PG interface, 90°	PROFIBUS bus connector RS 485 without PG interface, 35°	PROFIBUS bus connector RS 485 with PG interface, 35°	PROFIBUS FastConnect bus connector RS485 with PG interface, 30°
Acceptability for application	For connecting PROFIBUS nodes to the PROFIBUS bus cable	For connecting PROFIBUS nodes to the PROFIBUS bus cable	For connecting PROFIBUS nodes to the PROFIBUS bus cable	For connecting PROFIBUS nodes to the PROFIBUS bus cable	For connecting PROFIBUS nodes to the PROFIBUS bus cable
Transmission rate					
Transfer rate with PROFIBUS	9.6 kbit/s ... 12 Mbit/s	9.6 kbit/s ... 12 Mbit/s	9.6 kbit/s ... 12 Mbit/s	9.6 kbit/s ... 12 Mbit/s	9.6 kbit/s ... 1.5 Mbit/s
Interfaces					
Number of electrical connections					
• for PROFIBUS cables	2	2	2	2	2
• for network components and terminal equipment	1	1	1	1	1
Design of electrical connection					
• for PROFIBUS cables	Screw	Screw	Screw	Screw	Integrated insulation displacement contacts for 2-wire PB FC installation cables
• for network components and terminal equipment	9-pin sub-D socket	9-pin sub-D socket	9-pin sub-D socket	9-pin sub-D socket	9-pin sub-D socket
• FastConnect		No	No	No	Yes
Mechanical data					
Design of terminating resistor	Integrated resistor combination, can be connected via slide switch	Integrated resistor combination, can be connected via slide switch	Integrated resistor combination, can be connected via slide switch	Integrated resistor combination, can be connected via slide switch	No integrated terminating resistor
Material of the enclosure	plastic	plastic	plastic	plastic	plastic
Design, dimensions and weight					
Type of cable outlet	90 degree cable outlet	90 degree cable outlet			
Width	15.8 mm	15.8 mm	15.8 mm	15.8 mm	15 mm
Height	64 mm	64 mm	54 mm	54 mm	57.6 mm
Depth	35.6 mm	35.6 mm	39.5 mm	39.5 mm	39.5 mm
Net weight	10 g	10 g	60 g	67 g	46 g
Permitted ambient conditions					
Ambient temperature					
• during operating	0 ... +60 °C	0 ... +60 °C	0 ... +60 °C	0 ... +60 °C	0 ... +60 °C
• during storage	-40 ... +70 °C	-40 ... +70 °C	-40 ... +70 °C	-40 ... +70 °C	-40 ... +70 °C
• during transport	-40 ... +70 °C	-40 ... +70 °C	-40 ... +70 °C	-40 ... +70 °C	-40 ... +70 °C
Relative humidity at 25 °C without condensation during operating maximum		95 %	95 %	95 %	95 %
Protection class IP	IP20	IP20	IP20	IP20	IP20
Product properties, functions, components general					
Product feature silicon-free	Yes	Yes	Yes	Yes	Yes
Product component					
• PG connection socket	No	Yes	No	Yes	No
• strain relief	Yes	Yes	Yes	Yes	Yes
Standards, specifications, approvals					
Verification of suitability					
• RoHS conformity	Yes	Yes	Yes	Yes	Yes
• UL-registration	Yes	Yes	Yes	Yes	Yes

Technical specifications (continued)

Article No.	6ES7972-0BA52-0XA0	6ES7972-0BB52-0XA0	6ES7972-0BA60-0XA0	6ES7972-0BB60-0XA0
Product-type designation	PROFIBUS FastConnect bus connector RS485 without PG interface, 90°	PROFIBUS FastConnect bus connector RS485 with PG interface, 90°	PROFIBUS FastConnect bus connector RS485 without PG interface, 35°	PROFIBUS FastConnect bus connector RS485 with PG interface, 35°
Acceptability for application	For connecting PROFIBUS nodes to the PROFIBUS bus cable	For connecting PROFIBUS nodes to the PROFIBUS bus cable	For connecting PROFIBUS nodes to the PROFIBUS bus cable	For connecting PROFIBUS nodes to the PROFIBUS bus cable
Transmission rate				
Transfer rate with PROFIBUS	9.6 kbit/s ... 12 Mbit/s	9.6 kbit/s ... 12 Mbit/s	9.6 kbit/s ... 12 Mbit/s	9.6 kbit/s ... 12 Mbit/s
Interfaces				
Number of electrical connections				
• for PROFIBUS cables	2	2	2	2
• for network components and terminal equipment	1	1	1	1
Design of electrical connection				
• for PROFIBUS cables	Integrated insulation displacement contacts for 2-wire PB FC installation cables	Integrated insulation displacement contacts for 2-wire PB FC installation cables	Integrated insulation displacement contacts for 2-wire PB FC installation cables	Integrated insulation displacement contacts for 2-wire PB FC installation cables
• for network components and terminal equipment	9-pin sub-D socket	9-pin sub-D socket	9-pin sub-D socket	9-pin sub-D socket
• FastConnect	Yes	Yes	Yes	Yes
Mechanical data				
	Integrated resistor combination, can be connected via slide switch	Integrated resistor combination, can be connected via slide switch	Integrated resistor combination, can be connected via slide switch	Integrated resistor combination, can be connected via slide switch
Material of the enclosure	plastic	plastic	plastic	plastic
Design, dimensions and weight				
Type of cable outlet	90 degree cable outlet	90 degree cable outlet	35 degree cable outlet	35 degree cable outlet
Width	15.8 mm	15.8 mm	15.8 mm	15.8 mm
Height	59 mm	59 mm	54 mm	54 mm
Depth	35.6 mm	35.6 mm	39.5 mm	39.5 mm
Net weight	10 g	10 g	29 g	34 g
Permitted ambient conditions				
Ambient temperature				
• during operating	0 ... +60 °C	0 ... +60 °C	0 ... +60 °C	0 ... +60 °C
• during storage	-40 ... +70 °C	-40 ... +70 °C	-40 ... +70 °C	-40 ... +70 °C
• during transport	-40 ... +70 °C	-40 ... +70 °C	-40 ... +70 °C	-40 ... +70 °C
Relative humidity at 25 °C without condensation during operating maximum	95 %	95 %	95 %	95 %
Protection class IP	IP20	IP20	IP20	IP20
Product properties, functions, components general				
Product feature silicon-free	Yes	Yes	Yes	Yes
Product component				
• PG connection socket	No	Yes	No	Yes
• strain relief	Yes	Yes	Yes	Yes
Standards, specifications, approvals				
Verification of suitability				
• RoHS conformity	Yes	Yes	Yes	Yes
• UL-registration	Yes	Yes	Yes	Yes

PROFIBUS**Electrical networks (RS485)****RS485 bus connector****Technical specifications (continued)**

Article No.	6ES7972-0BA70-0XA0	6ES7972-0BB70-0XA0	6GK1500-0EA02	6GK1500-0FC10
Product-type designation	PROFIBUS FastConnect bus connector RS485 without PG interface, 90°	PROFIBUS FastConnect bus connector RS485 with PG interface, 90°	PROFIBUS bus connector RS 485	PROFIBUS FC bus connector RS 485
Acceptability for application	For connecting PROFIBUS nodes to the PROFIBUS bus cable	For connecting PROFIBUS nodes to the PROFIBUS bus cable	For connecting PROFIBUS nodes to the PROFIBUS bus cable	For connecting PROFIBUS nodes to the PROFIBUS bus cable
Transmission rate				
Transfer rate with PROFIBUS	9.6 kbit/s ... 12 Mbit/s	9.6 kbit/s ... 12 Mbit/s	9.6 kbit/s ... 12 Mbit/s	9.6 kbit/s ... 12 Mbit/s
Interfaces				
Number of electrical connections				
• for PROFIBUS cables	2	2	2	2
• for network components and terminal equipment	1	1	1	1
Design of electrical connection				
• for PROFIBUS cables	Integrated insulation displacement contacts for 2-wire PB FC installation cables	Integrated insulation displacement contacts for 2-wire PB FC installation cables	Terminal blocks	Integrated insulation displacement contacts for 2-core PB FC installation cables
• for network components and terminal equipment	9-pin Sub-D plug	9-pin Sub-D plug	9-pin Sub-D plug	9-pin Sub-D plug
• FastConnect	Yes	Yes	No	Yes
Mechanical data				
Design of terminating resistor	Integrated resistor combination that can be selected with slide switch. Disconnect function: When the resistor is connected, the outgoing bus is isolated.	Integrated resistor combination that can be selected with slide switch.	Integrated resistor combination that can be selected with slide switch. Disconnect function: When the resistor is connected, the outgoing bus is isolated.	Integrated resistor combination that can be selected with slide switch. Disconnect function: When the resistor is connected, the outgoing bus is isolated.
Material of the enclosure	plastic	plastic	metal	plastic
Design, dimensions and weight				
Type of cable outlet	90 degree cable outlet	90 degree cable outlet	180 degree cable outlet	180 degree cable outlet
Width	15.8 mm	15.8 mm	15 mm	16 mm
Height	72 mm	72 mm	57 mm	62 mm
Depth	36.4 mm	36.4 mm	39 mm	34,5 mm
Net weight	34 g	10 g	100 g	40 g
Permitted ambient conditions				
Ambient temperature				
• during operating	0 ... 60 °C	0 ... 60 °C	0 ... 60 °C	0 ... 60 °C
• during storage	-40 ... +70 °C	-40 ... +70 °C	-25 ... +80 °C	-25 ... +80 °C
• during transport	-40 ... +70 °C	-40 ... +70 °C	-25 ... +80 °C	-25 ... +80 °C
Relative humidity at 25 °C without condensation during operating maximum	75 %	75 %	75 %	75 %
Protection class IP	IP20	IP20	IP20	IP20
Product properties, functions, components general				
Product feature silicon-free	Yes	Yes	Yes	Yes
Product component				
• PG connection socket	No	Yes	No	No
• strain relief	Yes	Yes	Yes	Yes
Standards, specifications, approvals				
Verification of suitability				
• RoHS conformity	Yes	Yes	Yes	Yes
• UL-registration	Yes	Yes	No	Yes

Ordering data	Article No.	Article No.	
RS485 bus connector with axial cable outlet (180°) For industrial PC, SIMATIC HMI OP, OLM; max. transmission rate 12 Mbit/s	6GK1500-0EA02	<i>PROFIBUS bus connector RS485 with FastConnect technology</i> PROFIBUS FastConnect bus connector RS485 with 90° cable outlet with insulation displacement, max. transmission rate 12 Mbps Without PG interface <ul style="list-style-type: none"> • 1 unit • 100 units With PG interface <ul style="list-style-type: none"> • 1 unit • 100 units without PG interface, grounding via control cabinet cover <ul style="list-style-type: none"> • 1 unit with PG interface, grounding via control cabinet cover <ul style="list-style-type: none"> • 1 unit PROFIBUS FastConnect RS485 bus connector with angled cable outlet (35°) with insulation displacement, max. transmission rate 12 Mbps <ul style="list-style-type: none"> • Without PG interface • With PG interface PROFIBUS FastConnect bus connector RS485 Plug 180 with insulation displacement terminals, with 180° cable outlet, for industrial PC, SIMATIC HMI OP, OLM; max. transmission rate 12 Mbit/s	
SIPLUS DP PB RS485 connector with axial cable outlet (180°) for medial stress; Based-on 6GK1 500-0EA02	6AG1500-0EA02-2AA0		
RS485 bus connector with cable outlet (90°) With screw-terminals, max. transmission rate 12 Mbit/s <ul style="list-style-type: none"> • Without PG interface • With PG interface 	6ES7972-0BA12-0XA0 6ES7972-0BB12-0XA0		
SIPLUS DP PB RS485 connector with 90° cable outlet for extended temperature range -25 ... + 60 °C <ul style="list-style-type: none"> • without PG interface Based on 6ES7 972-0BA12-0XA0 • with PG interface Based on 6ES7 972-0BB12-0XA0 	6AG1972-0BA12-2XA0 6AG1972-0BB12-2XA0		
RS485 bus connector with angled cable outlet (35°) With screw-terminals, max. transmission rate 12 Mbit/s <ul style="list-style-type: none"> • Without PG interface • With PG interface 	6ES7972-0BA42-0XA0 6ES7972-0BB42-0XA0		
SIPLUS DP PB RS485 connector with inclined cable outlet (35°) for extended temperature range -25 ... + 60 °C <ul style="list-style-type: none"> • without PG interface Based on 6ES7 942-0BA42-0XA0 • with PG interface Based on 6ES7 942-0BB42-0XA0 	6AG1972-0BA42-7XA0 6AG1972-0BB42-7XA0		
RS485 bus connector with cable outlet (30°) With screw-terminals, low-cost variant, max. transmission rate 1.5 Mbit/s	6ES7972-0BA30-0XA0		
			6ES7972-0BA52-0XA0 6ES7972-0BA52-0XB0
			6ES7972-0BB52-0XA0 6ES7972-0BB52-0XB0
			6ES7972-0BA70-0XA0 6ES7972-0BB70-0XA0
		6ES7972-0BA60-0XA0 6ES7972-0BB60-0XA0	
		6GK1500-0FC10	
		SIMATIC S5/S7 plug-in cable for PROFIBUS Preassembled with two 9-pin sub-D connectors; max. transmission rate 12 Mbit/s; 3 m	
		SIMATIC NET Manual Collection Electronic manuals for communication systems, communication protocols, and communication products; on DVD; German/English	
		6ES7901-4BD00-0XA0	
		6GK1975-1AA00-3AA0	

PROFIBUS

Electrical networks (RS485)

830-1T connecting cable

Overview



- Prefabricated cable for fast and cost-effective connection of PROFIBUS nodes to OLM and OBT
- Flexible PROFIBUS connecting cable

Benefits

get Designed for Industry

- Trouble-free connection of end stations through preassembled connecting leads
- Reliable data transmission to the end station in EMC-exposed environment through direct cable shielding and termination.

Design

The 830-1T connecting cable consists of a twisted-pair cable (wires made of stranded copper) with a woven shield.

It has a 9-pin Sub-D plug at both ends.

Both cable ends are terminated by a resistor combination (cannot be switched off).

Function

The PROFIBUS 830-1T connecting cable is used for connecting the electrical PROFIBUS interface to the PROFIBUS nodes (OLM, OBT and data terminals) for data transmission rates of up to 12 Mbit/s.

Technical specifications

Article No.	6XV1830-1CH15	6XV1830-1CH30
Product-type designation	connecting cable 830-1T	connecting cable 830-1T
Acceptability for application	For connecting PROFIBUS nodes to OLM or OBT	For connecting PROFIBUS nodes to OLM or OBT
Cable length	1.5 m	3 m
Mechanical data		
Net weight	-	-

Ordering data

Article No.

830-1T PROFIBUS connecting cable

for terminal connection, preassembled, with two Sub-D plugs, 9-pin terminated at both ends

- 1.5 m long
- 3 m long

6XV1830-1CH15
6XV1830-1CH30

Overview



- Prefabricated cable for connection of PROFIBUS nodes (e.g. HMI) to PLCs
- Flexible PROFIBUS connection cable for up to 12 Mbit/s

Benefits

get **Designed for Industry**

- Trouble-free connection of end stations through preassembled connecting leads
- Direct connection of a PG through the PG interface without interrupting the connection between the stations.

Design

The 830-2 connecting cable comprises a standard PROFIBUS bus cable. It is preassembled with two 9-pin connectors (6GK1 500-0EA02 and 6ES7 972-0BB11-0XA0). One plug of the preassembled connecting cable is equipped with a PG interface.

Function

The 830-2 connecting cable is used to connect PROFIBUS nodes (e.g. HMI) to automation devices for transmission rates up to 12 Mbit/s.

Technical specifications

Article No.	6XV1830-2AH30	6XV1830-2AH50	6XV1830-2AN10
Product-type designation	PROFIBUS connecting cable 830-2	PROFIBUS connecting cable 830-2	PROFIBUS connecting cable 830-2
Acceptability for application	Cable for connecting PROFIBUS stations (e.g. HMI) to automation devices	Cable for connecting PROFIBUS stations (e.g. HMI) to automation devices	Cable for connecting PROFIBUS stations (e.g. HMI) to automation devices
Cable length	3 m	5 m	10 m
Mechanical data			
Net weight	-	-	-

Ordering data

Article No.

830-2 PROFIBUS connecting cable

Preassembled, with two 9-pin connectors

- 3 m long
- 5 m long
- 10 m long

6XV1830-2AH30
 6XV1830-2AH50
 6XV1830-2AN10

PROFIBUS

Electrical networks (RS485)

PROFIBUS M12 and 7/8" connecting cable/connector

Overview



Flexible connecting cables and FastConnect (FC) plug-in connectors that can be assembled in the field for transmission of data (up to 12 Mbit/s) or for power supply between PROFIBUS nodes with IP65 degree of protection

PROFIBUS M12 plug-in cable

- Preassembled plug-in cable (PROFIBUS FC Trailing Cable) for connecting PROFIBUS nodes (e.g. SIMATIC ET 200) to IP65 degree of protection
- For transmission rates up to 12 Mbit/s

7/8" connecting cable

- Preassembled plug-in cable for supplying power to PROFIBUS nodes (e.g. SIMATIC ET 200) to IP65 degree of protection

PROFIBUS FC M12 Plug PRO (B-coded) and 7/8" plug-in connector

- For establishing direct connections between devices on PROFIBUS installation and power cables with M12 or 7/8" connections
- Excellent EMC shielding and deflection (metal housing)
- Easy assembly due to integrated FastConnect technology (FC M12 Plug)
- Viewable contact area prevents errors

Benefits

get **Designed for Industry**

- Time-saving and fault-free connection of terminal stations by means of prefabricated connection cables
- Easy assembly on site for application-specific M12 and 7/8" plug-in cables by means of FC M12 and 7/8" plug-in connectors that can be assembled in the field

Design

M12 plug-in cable

- Comprises the PROFIBUS Trailing Cable
- Pre-assembled with two 5-pole M12 male/female connectors; B-coded

7/8" plug-in cable

- Comprises the Energy Cable 5 x 1.5 mm²
- Pre-assembled with two 5-pole 7/8" male/female connectors

Technical specifications

Article No.	6XV1830-3DH10	Article No.	6XV1830-3DH10
Product-type designation	PROFIBUS M12 connecting cable	Product-type designation	PROFIBUS M12 connecting cable
Product description	Flexible connecting cable (2-core), preferred length, preassembled with two 5-pin M12 plugs/sockets (B-coded)	Color	red / green Petrol
Acceptability for application	Cable for connecting PROFIBUS stations (e.g. SIMATIC ET 200) to IP 65 degree of protection	Bending radius	40 mm
Cable designation	02YY (ST) C11Y 1x2x0.65/2.56-150 LI KF 40 FR petrol	<ul style="list-style-type: none"> with single bend minimum permissible with multiple bends minimum permissible with continuous bending 	- 120 mm
Cable length	1 m	Number of bending cycles	3 000 000
Electrical data		<ul style="list-style-type: none"> Note 	For use in cable carriers, for 3 million bending cycles with a bending radius of 120 mm (15x D) and an acceleration of 4 m/s ²
Damping ratio per length		Number of torsion cycles with torsion by ± 180° on 1 m cable length	-
<ul style="list-style-type: none"> at 9.6 kHz maximum at 38.4 kHz maximum at 4 MHz maximum at 16 MHz maximum 	0.003 dB/m 0.004 dB/m 0.025 dB/m 0.049 dB/m	Traction stress maximum	100 N
Impedance		Weight per length	77 kg/km
<ul style="list-style-type: none"> Nominal value at 9.6 kHz at 38.4 kHz for frequency range 3 MHz ... 20 MHz 	150 Ω 270 Ω 185 Ω 150 Ω	Permitted ambient conditions	
Relative symmetrical tolerance		Ambient temperature	
<ul style="list-style-type: none"> of the surge impedance at 9.6 kHz of the surge impedance at 38.4 kHz of the surge impedance at 3 MHz ... 20 MHz 	10 % 10 % 10 %	<ul style="list-style-type: none"> during operating during storage during transport during installation 	-40 ... +60 °C -40 ... +60 °C -40 ... +60 °C -40 ... +60 °C
Loop resistance per length maximum	133 Ω/km	Ambient condition for (standard) operation mode	Limited segment length (see manual for PROFIBUS networks)
Shield resistance per length maximum	14 Ω/km	Protection class IP	IP65/67
Capacity per length at 1 kHz	28 pF/m	Burning behaviour	flame resistant according to IEC 60332-1-2
Operating voltage RMS value	100 V	Chemical resistance	
Mechanical data		<ul style="list-style-type: none"> to mineral oil to grease to water 	oil resistant according to IEC 60811-2-1 (7x24h/90°C) Resistant Conditional resistance
Number of electrical wires	2	Radiological resistance to UV radiation	Resistant
Design of shield	Overlapped aluminum-clad foil, sheathed in a braided screen of tin-plated copper wires	Product properties, functions, components general	
Design of the electrical connection FastConnect	Yes	Product feature	
Outer diameter		<ul style="list-style-type: none"> halogen-free silicon-free 	No Yes
<ul style="list-style-type: none"> of the inner conductor of the wire insulation of the inner sheath of the cable of the cable sheath 	0.67 mm 2.56 mm 5.4 mm 8 mm	Cable length	
Symmetrical tolerance of outer diameter of cable sheath	0.4 mm	<ul style="list-style-type: none"> at max. 1.5 Mbit/s at max. 12 Mbit/s 	- -
Outer diameter of the cable sheath Note	-	Standards, specifications, approvals	
Material		UL/ETL listing with 300 V rating	Yes: CMX
<ul style="list-style-type: none"> of the wire insulation of the inner sheath of the cable of the cable sheath - Note 	PE PVC PUR -	UL/ETL style with 600 V rating	No
		Verification of suitability	
		<ul style="list-style-type: none"> CE mark UL-registration - RoHS conformity 	- - Yes
		Marine classification association	
		<ul style="list-style-type: none"> Germanische Lloyd (GL) Lloyds Register of Shipping (LRS) 	No No

PROFIBUS

Electrical networks (RS485)

PROFIBUS M12 and 7/8" connecting cable/connector

Technical specifications (continued)

Article No.	6XV1822-5BH10
Product-type designation	7/8 connecting cable
Product description	Connecting cable (5-core), preferred length, preassembled with two 5-pin 7/8" plugs/sockets
Acceptability for application	Power supply of ET 200 modules with 7/8 inch power port to IP 65 degree of protection
Cable designation	L-Y11Y-Z 5x1x1.5 GR
Cable length	1 m
Electrical data	
Operating voltage RMS value	600 V
Conductor cross section of the power wires	1.5 mm ²
Continuous current of the power wires	16 A
Mechanical data	
Number of electrical wires	5
Design of shield	-
Design of the electrical connection FastConnect	-
Outer diameter	
• of the inner conductor	1.55 mm
• of the wire insulation	2.73 mm
• of the cable sheath	10.5 mm
Symmetrical tolerance of outer diameter of cable sheath	0.3 mm
Outer diameter of the cable sheath Note	-
Material	
• of the wire insulation	PVC
• of the cable sheath	PUR
- Note	-
Color	
• of the power wire insulation	Black
• of the cable sheath	gray
Bending radius	
• with single bend minimum permissible	27 mm
• with multiple bends minimum permissible	63 mm
• with continuous bending	75 mm
Number of bending cycles	5 000 000
• Note	For use in cable carriers, for 5 million bending cycles with a bending radius of 75 mm, an acceleration of 4 m/s ² and a speed of 180 m/min
Number of torsion cycles with torsion by ± 180° on 1 m cable length	-
Traction stress maximum	500 N
Weight per length	149 kg/km

Article No.	6XV1822-5BH10
Product-type designation	7/8 connecting cable
Permitted ambient conditions	
Ambient temperature	
• during operating	-40 ... +80 °C
• during storage	-40 ... +80 °C
• during transport	-40 ... +80 °C
• during installation	-40 ... +80 °C
• Comment	-
Ambient condition for (standard) operation mode	-
Protection class IP	IP65/67
Burning behaviour	Flame-retardant in accordance with IEC 60332-1
Chemical resistance	
• to mineral oil	Resistant
• to grease	Resistant
• to water	-
Radiological resistance to UV radiation	Resistant
Product properties, functions, components general	
Product feature	
• halogen-free	No
• silicon-free	Yes
Standards, specifications, approvals	
UL/ETL listing with 300 V rating	No
UL/ETL style with 600 V rating	Yes
Verification of suitability	
• CE mark	-
• UL-registration	-
• RoHS conformity	Yes

Technical specifications (continued)

Article No.	6GK1905-0EA10	6GK1905-0EB10	6GK1905-0EA00	6GK1905-0EB00
Product-type designation	PB FC M12 Plug PRO	PB FC M12 Cable Connector PRO	PB M12 connector	PB M12 connector
Product description	M12 connector with male contact insert, 5-pin, B-coded	M12 connector with female contact insert, 5-pin, B-coded	M12 connector with male contact insert, 5-pin, B-coded	M12 connector with female contact insert, 5-pin, B-coded
Acceptability for application	For connecting electrical PB FC bus cables to ET200 PRO, suitable for fast assembly with the FastConnect system	For connecting electrical PB FC bus cables to ET200 PRO, suitable for fast assembly with the FastConnect system	For connecting electrical PB bus cables to ET200	For connecting electrical PB bus cables to ET200
Transmission rate				
Transfer rate with PROFIBUS	9.6 kbit/s ... 12 Mbit/s	9.6 kbit/s ... 12 Mbit/s	9.6 kbit/s ... 12 Mbit/s	9.6 kbit/s ... 12 Mbit/s
Interfaces				
Number of electrical connections				
• for PROFIBUS cables	1	1	1	1
• for network components and terminal equipment	1	1	1	1
Design of electrical connection				
• for PROFIBUS cables	Integrated insulation displacement contacts for 2-core PB FC installation cables	Integrated insulation displacement contacts for 2-core PB FC installation cables	Integrated screw-type contacts for 2-core PB installation cables	Integrated screw-type contacts for 2-core PB installation cables
• for network components and terminal equipment	M12 connector (male insert, 4-pin, B-coded)	M12 connector (female insert, 5-pin, B-coded)	M12 connector (male insert, 4-pin, B-coded)	M12 connector (female insert, 5-pin, B-coded)
• FastConnect	Yes	Yes	No	No
Mechanical data				
Design of terminating resistor	-	-	-	-
Material of the enclosure	metal	metal	metal	metal
Design, dimensions and weight				
Type of cable outlet	180 degree cable outlet	180 degree cable outlet	180 degree cable outlet	180 degree cable outlet
Width	19 mm	19 mm	19 mm	19 mm
Height	19 mm	19 mm	19 mm	19 mm
Depth	73 mm	73 mm	73 mm	73 mm
Net weight	40 g	40 g	40 g	40 g
Permitted ambient conditions				
Ambient temperature				
• during operating	-40 ... +85 °C	-40 ... +85 °C	-40 ... +70 °C	-40 ... +70 °C
• during storage	-40 ... +85 °C	-40 ... +85 °C	-40 ... +80 °C	-40 ... +80 °C
• during transport	-40 ... +85 °C	-40 ... +85 °C	-40 ... +80 °C	-40 ... +80 °C
Relative humidity at 25 °C without condensation during operating maximum	-	-	-	-
Protection class IP	IP65/67	IP65/67	IP65/67	IP65/67
Chemical resistance to water	resistant	resistant	resistant	resistant
Product properties, functions, components general				
Product feature silicon-free	Yes	Yes	Yes	Yes
Product component				
• PG connection socket	-	-	-	-
Product component strain relief	Yes	Yes	Yes	Yes
Standards, specifications, approvals				
Verification of suitability				
• RoHS conformity	Yes	Yes	Yes	Yes
• UL-registration	Yes	Yes	No	No

PROFIBUS

Electrical networks (RS485)

PROFIBUS M12 and 7/8" connecting cable/connector

Technical specifications (continued)

Article No.	6GK1905-0FA00	6GK1905-0FB00
Product-type designation	7/8-inch connector	7/8-inch connector
Product description	7/8" connector with pin insert, 5-pin	7/8" connector with female contact insert, 5-pin
Acceptability for application	For field assembly with ET200	For field assembly with ET200
Transmission rate		
Transfer rate with PROFIBUS	-	-
Interfaces		
Number of electrical connections for network components and terminal equipment	1	1
Design of electrical connection for network components and terminal equipment	7/8 inch plug (male insert)	7/8 inch plug (female insert)
Mechanical data		
Material of the enclosure	metal	metal
Design, dimensions and weight		
Type of cable outlet	180 degree cable outlet	180 degree cable outlet
Width	27 mm	27 mm
Height	27 mm	27 mm
Depth	83 mm	83 mm
Net weight	50 g	50 g
Permitted ambient conditions		
Ambient temperature		
• during operating	-40 ... +70 °C	-40 ... +70 °C
• during storage	-40 ... +80 °C	-40 ... +80 °C
• during transport	-40 ... +80 °C	-40 ... +80 °C
Relative humidity at 25 °C without condensation during operating maximum	-	-
Protection class IP	IP65/67	IP65/67
Chemical resistance to water	resistant	resistant
Product properties, functions, components general		
Product feature silicon-free	Yes	Yes
Product component strain relief	Yes	Yes
Standards, specifications, approvals		
Verification of suitability RoHS conformity	Yes	Yes

PROFIBUS M12 and 7/8" connecting cable/connector
Ordering data
PROFIBUS M12 plug-in cable

Pre-assembled with two 5-pole M12 male/female connectors up to 100 m max.; length:

- 0.3 m
- 0.5 m
- 1.0 m
- 1.5 m
- 2.0 m
- 3.0 m
- 5.0 m
- 10 m
- 15 m

Further special lengths with 90° or 180° cable outlet

Article No.

6XV1830-3DE30
6XV1830-3DE50
6XV1830-3DH10
6XV1830-3DH15
6XV1830-3DH20
6XV1830-3DH30
6XV1830-3DH50
6XV1830-3DN10
6XV1830-3DN15

See
<http://support.automation.siemens.com/WWW/view/en/26999294>

7/8" plug-in cable

For power supply; pre-assembled with two 5-pole 7/8" male/female connectors up to 50 m max.; length:

- 0.3 m
- 0.5 m
- 1.0 m
- 1.5 m
- 2.0 m
- 3.0 m
- 5.0 m
- 10 m
- 15 m

Additional special lengths with 90° or 180° cable outlet

6XV1822-5BE30
6XV1822-5BE50
6XV1822-5BH10
6XV1822-5BH15
6XV1822-5BH20
6XV1822-5BH30
6XV1822-5BH50
6XV1822-5BN10
6XV1822-5BN15

See
<http://support.automation.siemens.com/WWW/view/en/26999294>

Article No.
Plug-in connector for assembly in the field
PROFIBUS M12 connectors

5-pole, B-coded, metal casing, 1 pack = 5 items

- Male pins
- Socket insert

6GK1905-0EA00
6GK1905-0EB00

PROFIBUS FC M12 Plug PRO

M12 plug-in connector (B-coded) that can be assembled in the field, 5-pin, metal enclosure, FastConnect technology, pin insert; 1 pack = 5 items

6GK1905-0EA10

PROFIBUS FC M12 Cable Connector PRO

M12 plug-in connector (B-coded) that can be assembled in the field, 5-pin, metal enclosure, FastConnect technology, socket insert;

- 1 pack = 5 items

6GK1905-0EB10

7/8" plug-in connector

5-pole, plastic casing, 1 pack = 5 items

- Male pins
- Socket insert

6GK1905-0FA00
6GK1905-0FB00

Power cables
Energy Cable (5 x 1.5 mm²)

Power cable with trailing capability with 5 copper cores (1.5 mm²) for connecting to 7/8" plug-in connector; sold by the meter; max. 1 000 m; minimum order quantity 20 m

6XV1830-8AH10

7/8" Power T-Tap PRO

Power T-piece for ET 200 with two 7/8" socket inserts and one 7/8" pin insert 1 pack = 5 items

6GK1905-0FC00

PROFIBUS

Electrical networks (RS485)

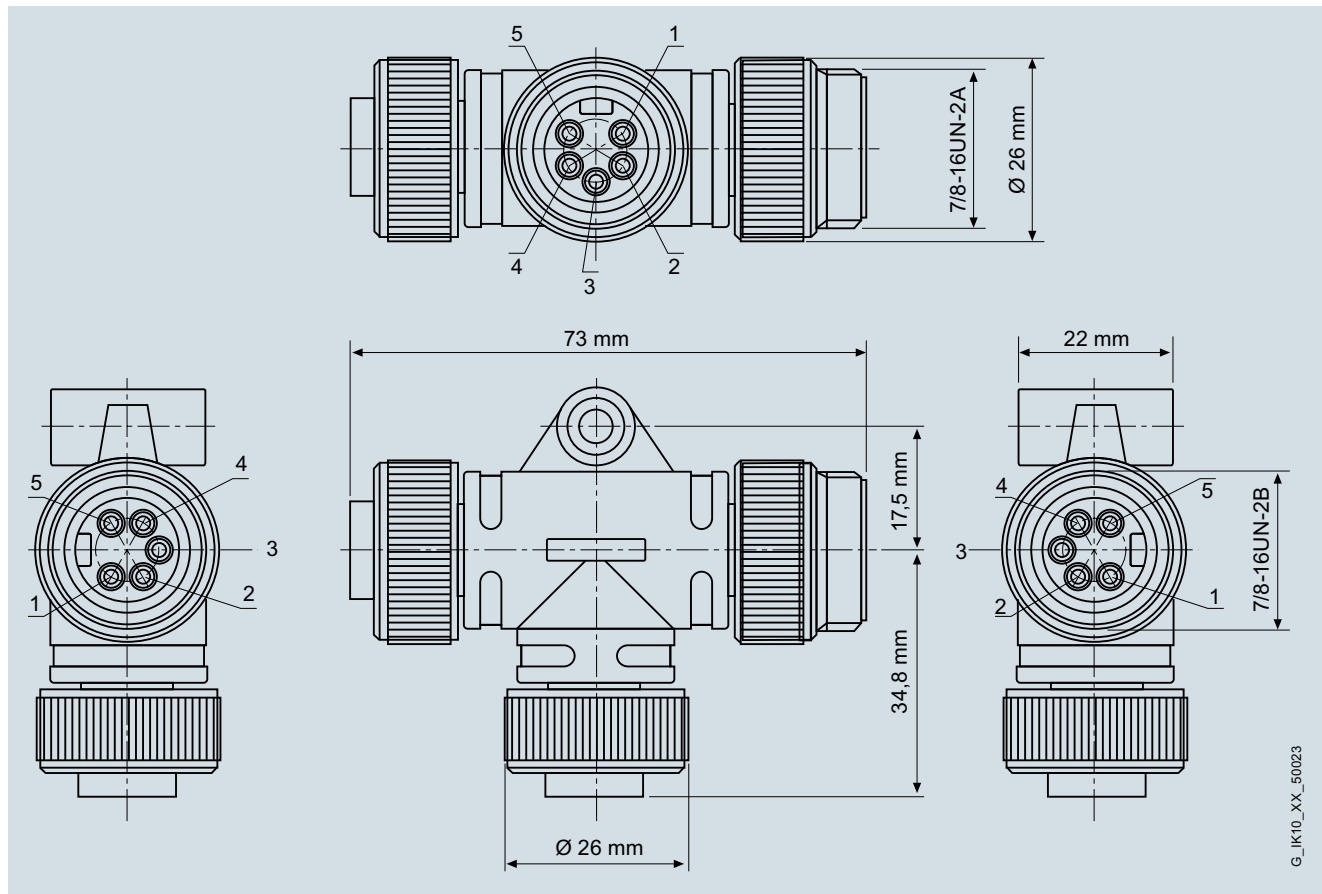
PROFIBUS M12 and 7/8" connecting cable/connector**Dimensional drawings**

7/8" Power T-Tap PRO

More information**Special lengths with 90° or 180° cable outlet**

You can find more information on the Internet at:

<http://support.automation.siemens.com/WW/view/en/26999294>

Overview



- For connecting PROFIBUS nodes with an RS485 interface to a segment
- Versions with transmission rates from 9.6 kbit/s to 12 Mbit/s
- Clear and easy mounting (can be snapped onto DIN rail)
- Clear location of faulty bus termination when bus terminal 12M is used
- PG connection with special bus terminal and PG connecting cable possible without additional installation of network nodes for bus terminal RS485.

Benefits



- Easy and clearly comprehensible connection of PROFIBUS stations thanks to preassembled, integrated connecting cable
- Simple cabinet pre-wiring by connecting the PROFIBUS connecting cable with integrated interfaces

Application

The PROFIBUS bus terminals enable a bus station to be connected to a PROFIBUS network.

- Pre-wired device connection for PROFIBUS node
- Easy connection of stations to PROFIBUS networks through insertion of the radial line with Sub-D plug
- Implementation of multipoint connections by directly interconnecting several bus terminals (up to 32 stations per segment) with the 12M bus terminal.

Design

Different versions are available:

- Up to 1.5 Mbit/s
Bus terminal RS485
- Up to 12 Mbit/s
Bus terminal 12M

Applicable to all versions:

- IP20 enclosure.
- Wall mounting or mounting on deep standard DIN rail possible.
- External 6-pin terminal block for connection of incoming and outgoing bus cable and equipotential bonding conductors.
- Integrated connecting cable with Sub-D plug for connection of nodes.
- Combination of terminating resistors can be connected by means of rotary switch.

The following additionally applies to the bus terminal 12M:

- Ranges for transmission rates can be adjusted by means of rotary switches.
- Supply to the bus terminal 12M by the connected PROFIBUS node (5 V DC/90 mA) via 9-pin Sub-D socket.
- For maximum segment lengths, see Technical Specifications.
- Incoming and outgoing bus cables are disconnected when inserting the terminating resistors.

PROFIBUS

Electrical networks (RS485)

Bus terminals

Function

- Connection of stations by means of integrated connecting cable with Sub-D plug.
- Easy connection of the bus cable by means of terminal block
- No interruption of bus if an end user station is missing
- Bus termination is possible by means of an integrated combination of terminating resistors.

The following additionally applies to the bus terminal 12M:

- Clear location of faulty termination within a segment (incoming and outgoing bus cables are separated when inserting the resistor combination)
- If the bus terminal 12M is used in a segment with RS485 bus terminals, the configuration rules of the RS485 bus terminal apply (see Manual for PROFIBUS Networks).

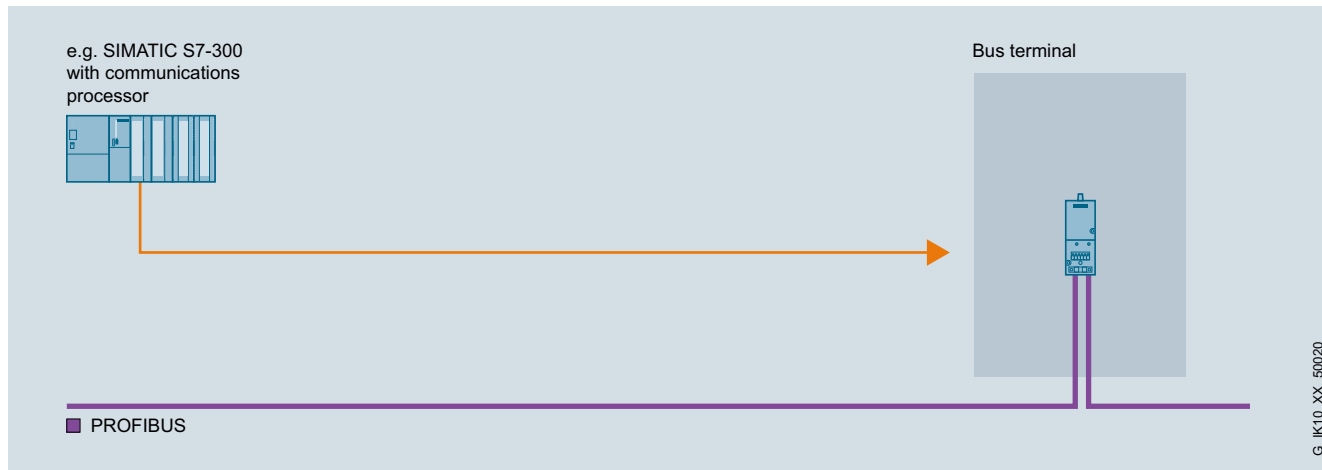

System connection with PROFIBUS bus terminals, e.g. for SIMATIC S7

Technical specifications

Article No.	6GK1500-0AA10	6GK1500-0AB00	6GK1500-0DA00
Product-type designation	PROFIBUS bus terminal 12M	Bus terminal RS 485 (3m)	Bus terminal RS 485 (1.5 m)
Electrical data			
Transfer rate with PROFIBUS			
• minimum	9.6 kbit/s	9.6 kbit/s	9.6 kbit/s
• maximum	12 Mbit/s	1.5 Mbit/s	1.5 Mbit/s
Interfaces			
Number of electrical connections for PROFIBUS cables	2	2	2
Mechanical data			
Material of the enclosure	plastic	plastic	plastic
Design, dimensions and weight			
Width	50 mm	50 mm	50 mm
Height	138 mm	138 mm	138 mm
Depth	53 mm	53 mm	53 mm
Net weight	360 g	360 g	360 g
Mounting type 35 mm DIN rail mounting	Yes	Yes	Yes
Standards, specifications, approvals			
Verification of suitability UL-registration	Yes	-	-

Ordering data

Ordering data	Article No.	Ordering data	Article No.
Bus terminal RS485 for PROFIBUS	6GK1500-0AB00	PROFIBUS bus terminal 12M	6GK1500-0AA10
Transmission rate 9.6 Kbit/s to 1 500 Kbit/s with plug-in cable 3.0 m long		Bus terminal for connection of PROFIBUS stations up to 12 Mbit/s with plug-in cable 1.5 m long	
Bus terminal RS485 for PROFIBUS	6GK1500-0DA00	SIMATIC NET Manual Collection	6GK1975-1AA00-3AA0
With installed programmer port and plug-in cable 1.5 m long		Electronic manuals for communication systems, communication protocols, and communication products; on DVD; German/English	

PROFIBUS

Electrical networks (RS485)

Active RS 485 terminating element

Overview



- Terminates bus segments at data transmission rates of 9.6 kbit/s to 12 Mbit/s
- Power supply independent of bus stations.

Designed for Industry

- Terminal-independent bus termination through onboard power supply

Application

The active RS 485 terminating resistance is used to terminate bus segments. Power supply is independent of the stations. The terminating resistor is supplied with power separately from the other I/O components, either permanently or with a voltage applied ahead of the I/Os. By terminating the bus system the stations (e.g. ET 200S) can be coupled and decoupled selectively without malfunctions.

Design

- 1 terminal block for the segment connection
- Terminal block for power supply (24 V DC external)

Function

The active RS 485 terminating element terminates the PROFIBUS and therefore ensures a defined level of the RS 485 signal and suppression of reflections on the line. Since it is operated independently of the field devices, they can be decoupled from the bus without reactions.

Technical specifications

6ES7972-0DA00-0AA0	
Supply voltage	
24 V DC	Yes
permissible range, lower limit (DC)	20.4 V
permissible range, upper limit (DC)	28.8 V
Input current	
Current consumption, typ.	30 mA
Interfaces	
Bus cables	Screw terminal block
PROFIBUS DP	
• Transmission rate, max.	12 Mbit/s; 9.6 kbit/s to 12 Mbit/s
Degree and class of protection	
IP20	Yes
Ambient conditions	
Operating temperature	
• Min.	0 °C
• max.	60 °C
Storage/transport temperature	
• Min.	-40 °C
• max.	70 °C
Relative humidity	
• max. relative humidity	95 %; at +25 °C
Connection method	
Power supply	Screw terminal block
Dimensions	
Width	60 mm
Height	70 mm
Depth	43 mm
Weights	
Weight, approx.	95 g

Ordering data

Article No.

Active RS 485 terminating element for PROFIBUS

6ES7972-0DA00-0AA0

to complete bus segments for transmission rates of 9.6 kbit/s to 12 Mbit/s

More information

Brochures

Information material for downloading can be found in the Internet:

<http://www.siemens.com/simatic/printmaterial>

Overview



- Automatic detection of transmission rates
- Transmission rates from 9.6 kbit/s to 12 Mbit/s are possible, incl. 45.45 kbit/s
- 24 V DC voltage display
- Indication of bus activity segment 1 and 2
- The separation of segment 1 and segment 2 by means of switches is possible
- Separation of the right segment with an inserted terminating resistor
- Decoupling of segment 1 and segment 2 in the case of static interference

Designed for Industry

- For increasing the expansion
- Electric isolation of segments
- Commissioning support
 - Switches for separation of segments
 - Bus activity display
 - Segment separation in the case of an incorrectly inserted terminating resistor

In this context, please also note the diagnostics repeater that provides extensive diagnostics functions for physical line diagnostics in addition to the normal repeater functionality. This is described in "Distributed I/O / diagnostics / diagnostics repeater for PROFIBUS DP".

Application

The RS 485 IP20 repeater connects two PROFIBUS or MPI bus segments using the RS 485 system with up to 32 stations. Data transmission rates of 9.6 kbit/s to 12 Mbit/s are then possible.

Design

- Housing to degree of protection IP20.
- 2 terminal blocks for connecting the segment
- Terminal block for supply voltage (24 V DC external).
- PG/OP interface.

Function

Mode of operation

- Increasing the number of stations (max. 127) and the expansion
- Regenerating the signals in amplitude and time
- Electrical isolation of the connected bus systems

Data transmission rate	Max. segment length
9.6 kbit/s	1 000 m
19.2 kbit/s	1 000 m
45.45 kbit/s	1 000 m
93.75 kbit/s	1 000 m
187.5 kbit/s	1 000 m
500 kbit/s	400 m
1 500 kbit/s	200 m
3 000 kbit/s	100 m
6 000 kbit/s	100 m
12 000 kbit/s	100 m

PROFIBUS**Electrical networks (RS485)****Repeater RS 485 for PROFIBUS****Technical specifications**

6ES7972-0AA02-0XA0	
Supply voltage	
24 V DC	Yes
permissible range, lower limit (DC)	20.4 V
permissible range, upper limit (DC)	28.8 V
Input current	
Current consumption, max.	100 mA; 100 mA without loads at PG/OP socket; 130 mA load at PG/OP socket (5 V/90 mA); 200 mA load at PG/OP socket (24 V/100 mA)
Interfaces	
Bus cables	2 terminal blocks
PROFIBUS DP	
• Transmission rate, max.	12 Mbit/s; 9.6 kbit/s to 12 Mbit/s
Degree and class of protection	
IP20	Yes
Ambient conditions	
Operating temperature	
• Min.	0 °C
• max.	60 °C
Storage/transport temperature	
• Min.	-40 °C
• max.	70 °C
Relative humidity	
• max. relative humidity	95 %; at 25 °C
Connection method	
Power supply	Terminal block
Dimensions	
Width	45 mm
Height	128 mm
Depth	67 mm
Weights	
Weight, approx.	350 g

Ordering data

RS 485 repeater for PROFIBUS
Transfer rate up to max. 12 Mbit/s,
24 V DC, enclosure IP20

Article No.**6ES7972-0AA02-0XA0****More information****Brochures**

Information material for downloading can be found in the Internet:

<http://www.siemens.com/simatic/printmaterial>

Overview



- RS 485 repeater with online line diagnostics for PROFIBUS DP
- DP standard PROFIBUS slave (DP-V1)
- Automatic determination of fault types and locations
- Data transmission rate 9.6 kbit/s to 12 Mbit/s
- Connection through FastConnect using the insulation displacement method

Application

The diagnostics repeater for PROFIBUS DP connects PROFIBUS DP segments with RS 485 technology. It also physically monitors the copper bus lines in online mode.

If an error occurs, it sends a diagnostic message to the DP master with detailed information on the type and location of the error.

The diagnostics repeater is a standard slave. It can be operated on any DP master that supports the standard RD_REC and WR_REC services. To record the topology, you will need either STEP 7 or COM PROFIBUS.

Design

- Enclosure with degree of protection IP20
- Assembly on S7-300 DIN rails or standard DIN rails
- LEDs to display 24 V DC, bus activity and line errors per segment
- Terminal block for external 24 V DC supply voltage
- 9-pin Sub-D socket for PG connection
- Connections for 3 bus segments with FastConnect insulation displacement connection
- The diagnostics repeater is integrated into the bus system as a PROFIBUS DP standard slave. It enables the following:
 - monitoring of 2 PROFIBUS DP segments
 - max. 31 stations per segment (max. 62 stations per diagnostics repeater)
 - max. segment length 100 m (independent of the baud rate)
 - configuration of up to 9 diagnostics repeaters in a row
- Use only approved bus connectors on the diagnostics-capable segments (see Ordering Information/Accessories)
- Observe the configuration guidelines for 12 MBaud networks

Function

Mode of operation

Repeater functionality

The diagnostics repeater is integrated into the bus system as a RS 485 repeater, but it has its own PROFIBUS DP address:

- Expansion of extension in the bus system
- Regeneration of the signals in edge steepness, amplitude and time (re-timing)
- Isolates connected segments
- Configuration in STEP 7, COM PROFIBUS or also using a GSD file.

As of FW Version V2.0.0, the following additional functions will be supported:

- I&M functions according to PROFIBUS Guideline Order No. 3.502 in version V1.1, dated May 2003
- Time synchronization via S7 mechanisms
- DP cycle time measurement and statistics

PROFIBUS

Electrical networks (RS485)

Diagnostics repeater for PROFIBUS DP

Function (continued)

Diagnostic functionality

Initiated by STEP 7, COM PROFIBUS or the user program (SIMATIC S7-400 / S7-300), the diagnostics repeater identifies the topology of the connected segments and saves this information in the internal diagnostic memory.

If an error occurs, the repeater automatically transmits a standard diagnostic message to the bus master with the following information:

- Affected segment
- Error location (e.g. between station X and Y)
- Distance from stations X and Y as well as from the repeater in meters to the error location
- Type of error

The following errors are diagnosed:

- Break in signal lines A or B
- Short circuit of signal lines A or B on the shield
- Absent terminating resistors
- Unacceptable cascading depth (between any two nodes, no more than 9 repeaters be connected in series)
- Too many stations in a segment
- Station too far from the diagnostics repeater
- Faulty messages

Sporadic errors are also detected.

The error messages are displayed graphically in STEP 7 and COM PROFIBUS. They are completely integrated in the SIMATIC system diagnostics (e.g. overview diagnostics, "Report system error" function).

The display in STEP7 also includes a help text with troubleshooting measures. The help text is written in a way that does not require specific PROFIBUS expertise, so that the error can be quickly localized and removed.

Network topology and statistics display

You can view the topology graphically in Step 7 as of V5.2. The stations and the line lengths are shown in the topology display.

You can also view the bus system quality in the form of statistical information.

Print function

STEP 7 V53.3, SP 3 includes an improved print function. It allows you to preview on the screen and optimize the printout. For instance, you can hide certain details and print out an overview of the topology on DIN A4 or DIN A3 paper.

Configuring

The diagnostics repeater is configured as follows:

- STEP 7 V5.1 or higher, incl. Service Pack 2
- COM PROFIBUS V5.1, incl. Service Pack 2
- External tools: Use GSD file

The topology can be determined using external masters with the help of the COM PROFIBUS. The topology cannot be identified using an external configuration tool. However, if the topology is determined once using the COM PROFIBUS, error location information will also be displayed in the external configuration tool.

Technical specifications

6ES7972-0AB01-0XA0	
Supply voltage	
24 V DC	Yes
permissible range, lower limit (DC)	20.4 V
permissible range, upper limit (DC)	28.8 V
Interfaces	
Bus cables	FastConnect insulation displacement, 10 clamping cycles possible
PROFIBUS DP	
• Transmission rate, max.	12 Mbit/s; 9.6 kbit/s to 12 Mbit/s
Degree and class of protection	
IP20	Yes
Ambient conditions	
Operating temperature	
• Min.	0 °C
• max.	60 °C
Storage/transport temperature	
• Min.	-40 °C
• max.	70 °C
Relative humidity	
• max. relative humidity	95 %; at 25 °C
Connection method	
Power supply	Terminal block
Dimensions	
Width	80 mm
Height	125 mm
Depth	67.5 mm
Weights	
Weight, approx.	300 g

Ordering data	Article No.	Article No.
RS 485 Diagnostic Repeater For connection of 1 or 2 segments to PROFIBUS DP; with online diagnostics functions for monitoring the bus cables	6ES7972-0AB01-0XA0	
Accessories RS 485 bus connector with 90° cable outlet With screw terminals Max. transfer rate 12 Mbit/s <ul style="list-style-type: none"> • Without PG interface • With PG interface 	6ES7972-0BA12-0XA0 6ES7972-0BB12-0XA0	Accessories (continued) PROFIBUS FastConnect RS 485 bus connector with angular cable outlet (35°) With insulation displacement terminals, max. transfer rate 12 Mbit/s <ul style="list-style-type: none"> • Without PG interface • With PG interface
PROFIBUS FastConnect bus connector RS 485 with 90° cable outlet With insulation displacement terminals Max. data transfer rate 12 Mbit/s Without PG interface <ul style="list-style-type: none"> • 1 unit • 100 units With PG interface <ul style="list-style-type: none"> • 1 unit • 100 units without PG interface, grounding via control cabinet cover <ul style="list-style-type: none"> • 1 unit with PG interface, grounding via control cabinet cover <ul style="list-style-type: none"> • 1 unit 	6ES7972-0BA52-0XA0 6ES7972-0BA52-0XB0 6ES7972-0BB52-0XA0 6ES7972-0BB52-0XB0 6ES7972-0BA70-0XA0 6ES7972-0BB70-0XA0	PROFIBUS FastConnect Stripping Tool Preadjusted stripping tool for fast stripping of PROFIBUS FastConnect bus cables
RS 485 bus connector with angled cable outlet (35°) With screw terminals, max. transfer rate 12 Mbit/s <ul style="list-style-type: none"> • Without PG interface • With PG interface 	6ES7972-0BA42-0XA0 6ES7972-0BB42-0XA0	PROFIBUS FC Standard Cable Standard type with special design for quick mounting, 2-core, shielded, sold by the meter, max. delivery unit 1 000 m, minimum order quantity 20 m
		S7 Manual Collection Electronic manuals on DVD, multilingual: S7-200, TD 200, S7-300, M7-300, C7, S7-400, M7-400, STEP 7, Engineering Tools, Runtime Software, SIMATIC DP (Distributed I/O), SIMATIC HMI (Human Machine Interface), SIMATIC NET (Industrial Communication)
		S7 Manual Collection update service for 1 year Scope of delivery: Current DVD "S7 Manual Collection" and the three subsequent updates
		Connecting cable for PROFIBUS 12 Mbit/s, for PG connection to PROFIBUS DP, preassembled with 2 x 9-pin sub D connector, 3.0 m

More information

Brochures

Information material for downloading can be found in the Internet:

<http://www.siemens.com/simatic/printmaterial>

PROFIBUS

Electrical networks (PROFIBUS PA)

Introduction

Overview

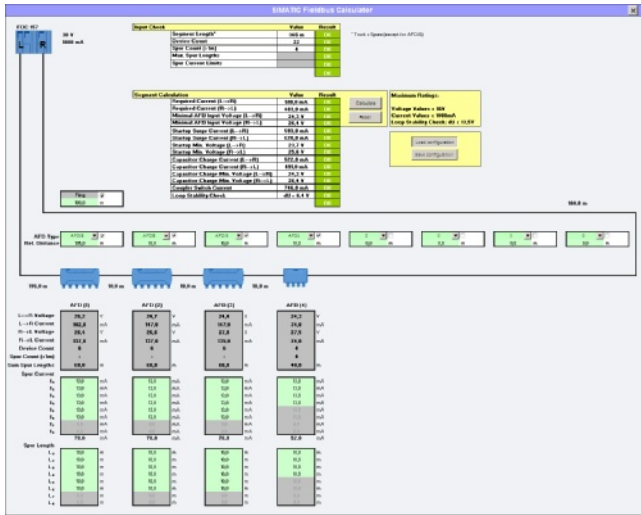

SIMATIC Fieldbus Calculator

Direct interfacing of the devices in the field, especially in the hazardous area, together with the information content of the communication, are of significant importance in the process industry. PROFIBUS PA, which permits both digital data transmission and the power supply on a two-wire line with the intrinsically-safe MBP transmission technology (Manchester Coded; Bus Powered) is tailored to these requirements. It is optimally suitable for direct integration of solenoid valves, sensors, and pneumatic actuators positioned in operating environments up to Ex zone 1/21 or 0/20 into the process control system.

The typical response time of a transmitter of approx. 10 ms indicates that short cycle times can be achieved with the PROFIBUS PA even in the case of a segment configuration with up to 31 devices. Practically all typical applications of the process industry can be implemented, both in small and large plants. Bidirectional communication and high information content allow enhanced diagnostics for fast and exact fault detection and elimination. The standardized communications services guarantee interoperability and replaceability between multi-vendor field devices and remote configuration of the field devices during operation.

Safety communication with the PROFIsafe profile

The PROFIsafe profile allows seamless integration of safety communication into the PROFIBUS PA. You need not configure a separate safety bus for your safety-related applications. The PROFIBUS PA with the PROFIsafe profile is incorporated in "Safety Integrated for Process Automation". This comprehensive range of products and services from Siemens for failsafe, fault-tolerant applications in the process industry offers you attractive and cost-effective alternatives to separate safety systems.

Redundant architectures

You can define the degree of redundancy separately for the controller, fieldbus and I/O levels of your plant depending on the automation task and the derived safety requirements, and match them to the field instrumentation (Flexible Modular Redundancy, FMR). You can find an overview of the redundant architectures of PROFIBUS PA under "Design".

Network transition PROFIBUS PA to PROFIBUS DP

The PA link is preferred as the gateway from PROFIBUS PA to PROFIBUS DP. When using the PA link, the transmission rate on the PROFIBUS DP is independent of the lower-level PROFIBUS PA segments. The configuration of the PA link depends on the fieldbus architecture. The types of coupler described in the section "PA routers" can be used for the configuration. With a small volume of data (small quantity structure) and low time requirements, the DP/PA coupler can also be operated in stand-alone mode as a gateway.

Benefits

Advantages provided by distributed field automation with application of the PROFIBUS PA profile included low hardware overhead, cost-effective engineering, increased operational safety and problem-free maintenance. These advantages are underlined by the following features:

- Modularity and uniformity from the sensor up to the control level permit new plant concepts
- Implementation of intrinsically-safe applications through use of the fieldbus in hazardous areas
- Redundant PROFIBUS PA architectures (ring and line topologies with coupler redundancy) support Flexible Modular Redundancy (FMR) from the automation system (controller) down to a PA field device
- Safety-related and fault-tolerant applications with low device and cabling requirements
- Reduced configuration costs through simple, central engineering of the field devices (PROFIBUS PA and HART with SIMATIC PDM, also cross-vendor)
- Simple installation using two wire cable for common power supply and data transmission
- Reduced commissioning costs through simplified loop check
- Low servicing costs thanks to simple wiring and comprehensive diagnostics facilities

Design

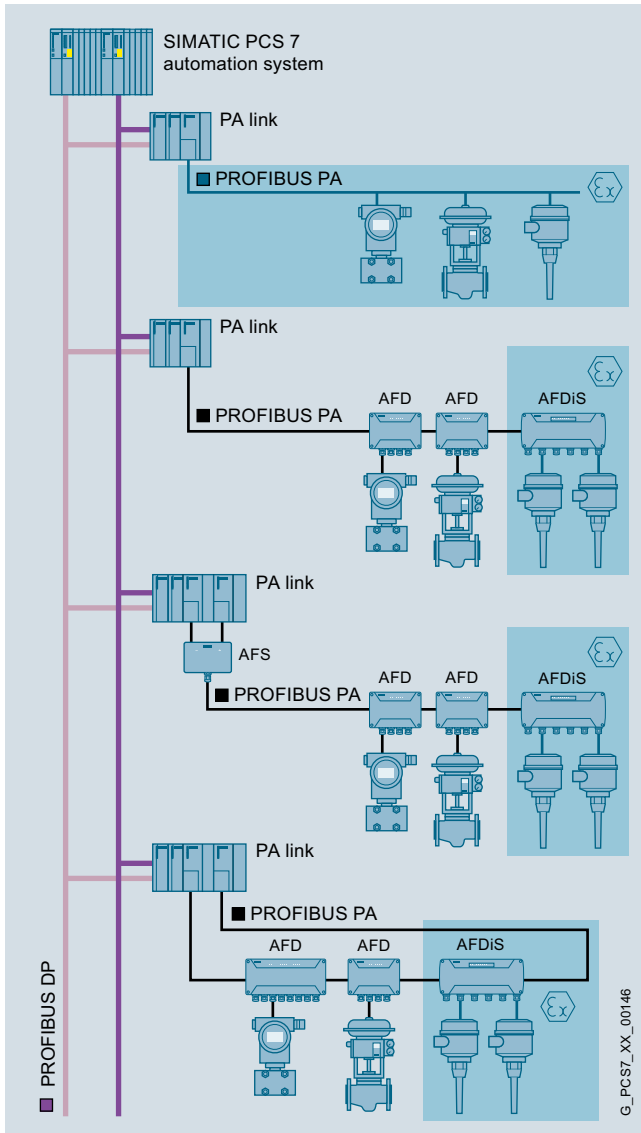

Basic PROFIBUS PA design versions when using the PA link as the PA router

Basic PROFIBUS PA design versions are shown at this point. The PA link is used as the PA router in these configuration examples.

However, the PA router can only be implemented per DP/PA coupler. The PROFIBUS DP connection is then directly on the coupler instead of per interface module.

The number of PROFIBUS PA devices is limited according to the specifications in section "Technical data".

Line architecture with single coupler

Max. 5 PROFIBUS PA lines (line segments) can be operated via single couplers (max. 3 for mixed configurations with ring or coupler redundancy) on a PA link as PA router, equipped with up to 5 DP/PA couplers.

In the line architecture with individual couplers, each line segment is connected to one DP/PA coupler of the PA router. The PA router can be connected to a single or redundant PROFIBUS DP.

The FDC 157-0 the first choice as the DP/PA coupler. When using this coupler, the PA devices can be integrated into the line segment via active field distributors AFD4 and AFD8 (approval for Ex zone 2/22) and AFDiS (approval for Ex zone 1/21). The PA devices are connected to these field distributors via short-circuit-proof spur lines.

Up to 8 field distributors of type AFD4/AFD8, 5 field distributors of type AFDiS, or 5 field distributors of both AFDiS and AFD4/AFD8 types combined can be optionally operated in a line segment. The last field distributor at the end of the line leading away from the DP/PA coupler automatically activates its bus terminating resistor.

Intrinsically-safe PA devices in hazardous areas in accordance with Ex zone 1/21 or 0/20 are primarily integrated into a bus segment by means of active field distributors AFDiS. For PA devices in Ex zone 1/21, the connection via a line segment on the PA router with DP/PA coupler Ex [i] is a possible alternative. The devices are integrated separately into the line segment via SplitConnect Taps (via spur line or directly via SplitConnect M12 outlet). A SplitConnect terminator is required for the bus termination of the segment.

By grouping individual devices in different line segments, Flexible Modular Redundancy is possible at device level.

Line architecture with redundant coupler

The PA link operable as a PA router on a single or redundant PROFIBUS DP can only be equipped with one redundant DP/PA coupler pair (up to 3 single couplers can also be optionally configured). The redundant DP/PA coupler pair can be used either for a line architecture with Active Field Splitter (AFS) or for a ring architecture.

With a line architecture, the AFS is connected to the redundant DP/PA coupler pair (2 x FDC 157-0) in the PA router. It connects the line segment connected to it to the active of the two redundant DP/PA couplers. A DP/PA coupler can be replaced without interrupting the ongoing operation.

The PA devices are integrated in the line segment as for a line architecture with single couplers via active field distributors AFD4, AFD8 or AFDiS. The limits with respect to the number of field distributors are also identical (up to 8 AFD4/AFD8, up to 5 AFDiS or up to 5 AFDiS and AFD4/AFD8 in any combination).

PROFIBUS

Electrical networks (PROFIBUS PA)

Introduction

Design (continued)

Ring architecture with coupler and media redundancy

With the redundant DP/PA coupler pair (2 x FDC 157-0) of a PA router, a ring segment with automatic bus termination can also be implemented instead of a line segment with AFS. Apart from the ring segment, only line segments with individual couplers can be configured on this PA router. The PA router can be connected to a single or a redundant PROFIBUS DP.

Integration of the PA field devices into the ring segment is carried out via active field distributors AFD4, AFD8 or AFDiS, the number of which is limited as with the line architectures (up to 8 AFD4/AFD8, up to 5 AFDiS or up to 5 AFDiS and AFD4/AFD8 in any combination). These field distributors have electrically decoupled, short-circuit-proof spur line connections for connecting the PA devices.

At the device level, flexible modular redundancy is possible by grouping individual devices on different field distributors.

Special advantages of the ring architecture:

- High availability
- Transparent redundancy management of the intelligent DP/PA couplers FDC 157-0 for the host system
- Active bus terminators for automatic bus termination in the DP/PA couplers FDC 157-0 and the active field distributors AFD4, AFD8 and AFDiS enable:
 - Automatic, smooth isolation of faulty subsegments in the event of a short-circuit or open-circuit
 - Modification of the ring configuration or instrumentation during operation, including the addition or removal of ring segments
- Safety-related and fault-tolerant applications with low device and cabling requirements

Cable lengths of bus segments and spur lines

The PROFIBUS PA is based on electrical transmission components. A shielded two-wire cable is used for digital data transmission and for the power supply of the field devices.

With line, tree and ring topologies, bus segments up to approx. 1.9 km can be configured. If AFD4/AFD8 active field distributors are used, the length of the spur lines for connecting devices and the quality of the cable used must also be considered when calculating the total length of the bus segment. Spur lines on the AFDiS are not relevant to the total length of the bus segment.

For bus segments with active field distributors, the spur lines can have the following maximum lengths:

- Up to 120 m in accordance with IEC 61158-2
- Up to 60 m in accordance with IEC 60079-27 (FISCO)

With AFD4/AFD8 active field distributors, these maximum values may be reduced depending on the number of spur lines of the bus segment (for details, see section "Technical specification"). With the active field distributor AFDiS, this reduction is canceled by the integrated repeater function.

The **SIMATIC Fieldbus Calculator** provides help in calculating and designing fieldbus segments:

<http://support.automation.siemens.com/WW/view/en/53842953>

Intrinsically-safe PA devices in hazardous areas are preferably integrated into a bus segment by means of active field distributors AFDiS. For PA devices in Ex zone 1/21, the connection via a line segment on the PA router with DP/PA coupler Ex [i] is a possible alternative. In such a configuration the max. possible length per spur line is reduced to 30 m and per bus segment to 1 km.

Bus segments are terminated either automatically (with architectures with active field distributors AFD4, AFD8, AFDiS) or with the passive terminating element for PROFIBUS PA (SplitConnect terminator).

Technical specifications

PROFIBUS PA

Data transmission	MBP
Transmission rate	31.25 Kbps
Cable	2-wire shielded
Type of protection	EEx(ia/ib)
Topology	Line, tree, ring
Active field distributors per segment/coupler	
• AFD4/AFD8	8
• AFDiS or combinations of AFDiS and AFD4/AFD8	5
PA devices per segment/coupler	31
PA devices per PA link	64
Max. current for all PA field devices of a segment (for PA gateways with FDC 157-0 coupler)	1 A
Cable length per segment, dependent on transmission rate	1 900 m: standard 1 900 m: EEx(ib) 1 000 m: EEx(ia)

Bus segments with AFD4/AFD8

Max. spur line length related to the total number of spur lines

Number of spur lines (1 device per spur line)	
• 1 to 12 spur lines	120 m
• 13 to 14 spur lines	90 m
• 15 to 18 spur lines	60 m
• 19 to 24 spur lines	30 m
• 25 to 31 spur lines	1 m

Bus segments with AFDiS

Max. spur line length independent of total number of spur lines

Number of spur lines (1 device per spur line)	
• 1 to 31 spur lines	
- Not intrinsically-safe	120 m
- Intrinsically-safe acc. to FISCO	60 m

Overview



- Used for constructing fieldbus segments as per IEC 61158-2 (e.g. PROFIBUS PA) with field device interface points
- Easy assembly of the bus cable thanks to the FastConnect system (FastConnect stripping tool, FC process cable compliant with IEC 61158-2)
- The terminal devices can be connected using the FC Process Cable in accordance with IEC 61158-2 or the SplitConnect M12 Outlet/M12 Jack
- Combination of terminating resistors can be integrated (SplitConnect terminator)

Benefits

get **Designed for Industry**

- Easy connection of terminals due to use of the FastConnect system
- Wide variety of applications thanks to modular SplitConnect system
- Reduction in number of types and parts thanks to uniform connection system for PROFIBUS PA

3

Application

- The SplitConnect Tap enables the design of fieldbus segments according to IEC 61158-2 (e.g. PROFIBUS PA) with terminal device connection points.
- The SplitConnect Coupler can be used to construct a PROFIBUS PA hub by connecting SplitConnect Taps in series.
- By replacing the contacting screw with the SplitConnect terminator, the SplitConnect tap can be used as a bus terminating element.

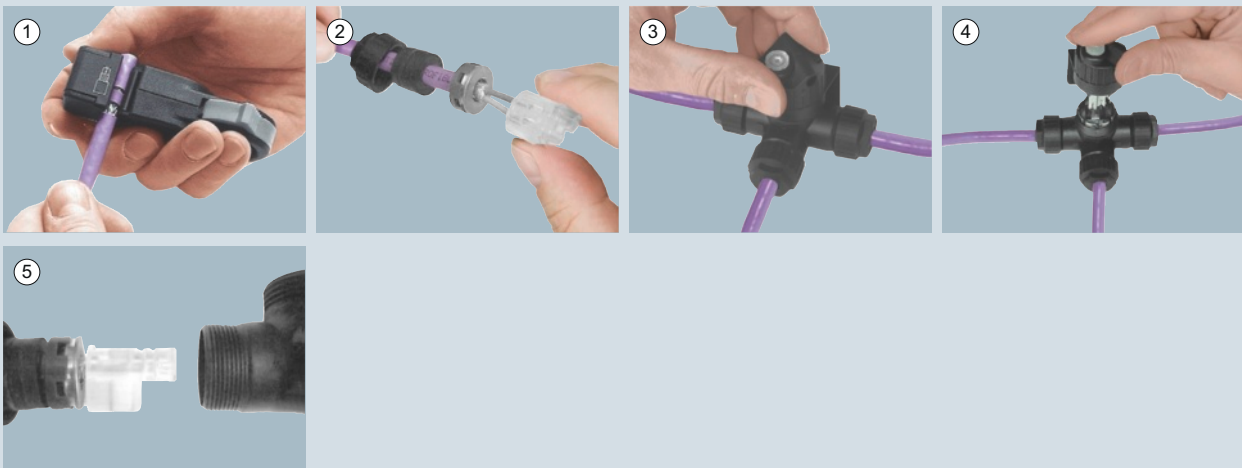

G_IK10_XX_50011

PROFIBUS

Electrical networks (PROFIBUS PA)

SplitConnect

Design



SplitConnect Coupler

SplitConnect M12 Outlet

SplitConnect Terminator

SplitConnect M12 Jack

Function

- The SplitConnect tap enables configuration of fieldbus segments according to IEC 61158-2 (e.g. PROFIBUS PA) and connection of terminals
- Easy pre-assembly of the SplitConnect taps through the FastConnect connection system (FastConnect stripping tool, FC Process Cable)
- Connection of the terminals directly through FC Process Cable or SplitConnect M12 outlet

- Rugged plastic casing made of PBT (polybutylene terephthalate) in IP67 design
- UV-resistant, making it possible to use outdoors
- Complete shielding by means of integrated metal enclosure
- Easier cable connection through the use of FC process cable
- Contacting and connection of the FC process cable by means of ID contacts using contacting screw
- Additional grounding of the SplitConnect tap possible by using a contacting screw
- DIN rail mounting or wall mounting possible

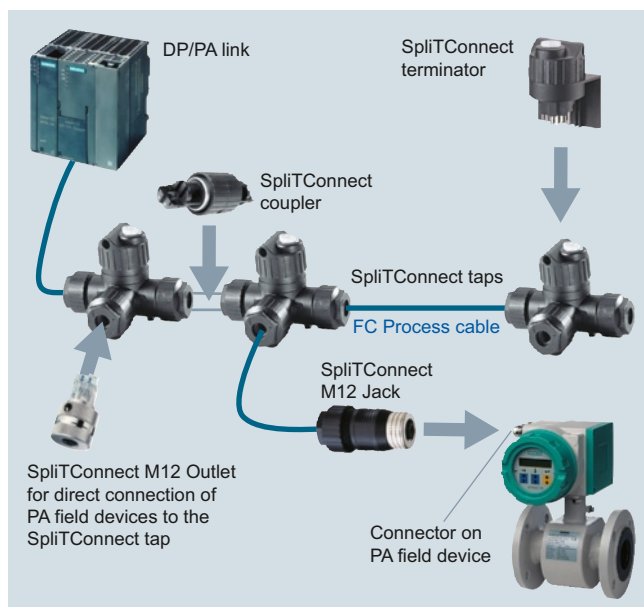

Technical specifications

Article No.	6GK1905-0AA00	6GK1905-0AB10	6GK1905-0AC00
Product-type designation	Split Connect Tap	Split Connect M12 Outlet	Split Connect Coupler
Interfaces			
Number of electrical connections	3	-	-
• for PROFIBUS cables	-	-	-
• for network components and terminal equipment	-	-	-
Design of the electrical connection	integrated insulation displacement contacts	-	-
• for PROFIBUS cables	-	-	-
• FastConnect	-	-	-
Mechanical data			
Cable gland version	-	-	-
Material of the enclosure	PBT (polybutyleneterephthalate)	-	-
Design, dimensions and weight			
Width	84 mm	-	-
Height	54 mm	-	-
Depth	49 mm	-	-
Net weight	170 g	-	-
Mounting type	Yes	-	-
35 mm DIN rail mounting	-	-	-
Mounting type wall mounting	Yes	-	-
Permitted ambient conditions			
Ambient temperature			
• during operating	-40 ... +85 °C	-40 ... +85 °C	-40 ... +85 °C
• during storage	-40 ... +85 °C	-40 ... +85 °C	-40 ... +85 °C
• during transport	-40 ... +85 °C	-40 ... +85 °C	-40 ... +85 °C
Protection class IP	IP67	IP67	IP67
Product properties, functions, components general			
Verification of suitability	Yes	-	-
UL-registration	-	-	-
Article No.	6GK1905-0AD00	6GK1905-0AE00	6GK1905-0AF00
Product-type designation	Split Connect Terminator (Ex)	Split Connect Terminator (non-Ex)	Split Connect M12 Jack
Interfaces			
Number of electrical connections	-	-	1
• for PROFIBUS cables	-	-	-
• for network components and terminal equipment	-	-	-
Design of the electrical connection	-	-	integrated insulation displacement contacts
• for PROFIBUS cables	-	-	-
• FastConnect	-	-	-
Mechanical data			
Material of the enclosure	-	-	-
Design, dimensions and weight			
Width	-	-	-
Height	-	-	-
Depth	-	-	-
Net weight	-	-	-
Mounting type	-	-	-
35 mm DIN rail mounting	-	-	-
Mounting type wall mounting	-	-	-
Permitted ambient conditions			
Ambient temperature			
• during operating	-40 ... +85 °C	-40 ... +85 °C	-40 ... +85 °C
• during storage	-40 ... +85 °C	-40 ... +85 °C	-40 ... +85 °C
• during transport	-40 ... +85 °C	-40 ... +85 °C	-40 ... +85 °C
Protection class IP	IP67	IP67	IP67
Product properties, functions, components general			
Verification of suitability	-	-	-
UL-registration	-	-	-

PROFIBUS**Electrical networks (PROFIBUS PA)****SplitConnect****Ordering data****Article No.****Article No.****SplitConnect Tap**

For assembling PROFIBUS PA segments and connecting PA field devices, insulation displacement method, IP67

Type of delivery:
1 package = 10 items

6GK1905-0AA00**SplitConnect terminator (Ex version)**

For terminating PROFIBUS PA segments, can be used in hazardous areas

Type of delivery:
1 package = 5 items

6GK1905-0AD00**SplitConnect M12 outlet**

Element for direct connection of PROFIBUS PA field devices to the SplitConnect tap through M12 connection

Type of delivery:
1 package = 5 items

6GK1905-0AB10**SplitConnect terminator (non-Ex version)**

For terminating PROFIBUS PA segments, cannot be used in hazardous area

Type of delivery:
1 package = 5 items

6GK1905-0AE00**SplitConnect coupler**

Coupling element for connecting SplitConnect taps in series to configure star points

Type of delivery:
1 package = 10 items

6GK1905-0AC00**SplitConnect M12 jack**

Connector element for direct connection of PROFIBUS PA field devices to the PROFIBUS PA segment through M12 connection

Type of delivery:
1 package = 5 items

6GK1905-0AF00

Overview

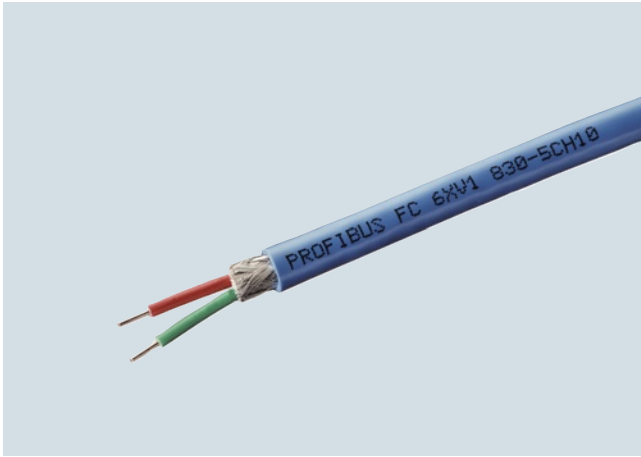

- Bus cable for fieldbus systems according to IEC 61158-2, e.g. PROFIBUS PA
- High interference immunity thanks to double shielding
- Different variants for different applications (hazardous areas, non-hazardous areas)
- Easy length measurement thanks to printed meter markings

Benefits

get **Designed for Industry**

- Length can easily be determined due to meter length markings printed on the cable
- Complete range of cables for hazardous and non-hazardous areas
- Reduction of types and parts thanks to a uniform connection system for PROFIBUS PA

Application

For the construction of fieldbus networks according to IEC 61158-2 (for example PROFIBUS PA), different color-coded cable types are available for the different types of applications (hazardous, non-hazardous areas).

UL approvals

Different cable variants are offered with appropriate UL approvals for laying in cable bundles and cable racks according to the specifications of NEC (National Electrical Code) Article 800/725.

Design

- Shielded, twisted-pair cable with circular cross-section
- System-wide grounding concept can be implemented using the external shield of the bus cable and the grounding terminals of the SplitConnect system.
- Printed meter marks.

Cable types

- FC Process Cable:
Special bus cable compliant with IEC 61158-2 for use in hazardous (Ex) and non-hazardous (non-Ex) areas.
- Bus segments with RS485 and IEC 61158-2 transmission procedures are linked by means of the segment coupler/link.

PROFIBUS

Electrical networks (PROFIBUS PA)

Bus cables

Technical specifications

Article No.	6XV1830-5FH10	6XV1830-5EH10
Product-type designation	PROFIBUS FC Process Cable GP	PROFIBUS FC Process Cable GP
Product description	Bus cable (2-core), sold by the meter, in bulk	Bus cable (2-core), sold by the meter, in bulk
Acceptability for application	For use in fieldbus systems according to IEC 61158-2 (e.g. PROFIBUS PA), suitable for non-Ex applications	For use in fieldbus systems according to IEC 61158-2 (e.g. PROFIBUS PA), suitable for Ex applications
Cable designation	02YSY (ST) CY 1x2x1.0/2.55-100 SW OE FR	02YSY (ST) CY 1x2x1.0/2.55-100 BL OE FR
Cable length	-	-
Electrical data		
Damping ratio per length at 38.4 kHz maximum	3 dB/km	3 dB/km
Impedance		
• Nominal value	100 Ω	100 Ω
• at 31.25 kHz	100 Ω	100 Ω
Relative symmetrical tolerance of surge impedance at 31.25 kHz	20 %	20 %
Loop resistance per length maximum	44 Ω/km	44 Ω/km
Shield resistance per length maximum	6.5 Ω/km	6.5 Ω/km
Capacity per length at 1 kHz	92 pF/m	92 pF/m
Inductance per length	0.65 μH/m	0.65 μH/m
Operating voltage RMS value	100 V	100 V
Mechanical data		
Number of electrical wires	2	2
Design of shield	Overlapped aluminum-clad foil, sheathed in a braided screen of tin-plated copper wires	Overlapped aluminum-clad foil, sheathed in a braided screen of tin-plated copper wires
Design of the electrical connection FastConnect	Yes	Yes
Outer diameter		
• of the inner conductor	1.05 mm	1.05 mm
• of the wire insulation	2.55 mm	2.55 mm
• of the inner sheath of the cable	5.4 mm	5.4 mm
• of the cable sheath	8 mm	8 mm
Symmetrical tolerance of outer diameter of cable sheath	0.4 mm	0.4 mm
Outer diameter of the cable sheath	-	-
Note		
Material		
• of the wire insulation	PE	PE
• of the inner sheath of the cable	PVC	PVC
• of the cable sheath	PVC	PVC
- Note	-	-
Color		
• of the insulation of data wires	red / green	red / green
• of the cable sheath	Black	Blue
Bending radius		
• with single bend minimum permissible	40 mm	40 mm
• with multiple bends minimum permissible	80 mm	80 mm
• with continuous bending	-	-
Number of bending cycles	-	-
• Note	-	-
Number of torsion cycles with torsion by ± 180° on 1 m cable length	-	-
Traction stress maximum	150 N	150 N
Weight per length	103 kg/km	103 kg/km

Technical specifications (continued)

Article No.	6XV1830-5FH10	6XV1830-5EH10
Product-type designation	PROFIBUS FC Process Cable GP	PROFIBUS FC Process Cable GP
Permitted ambient conditions		
Ambient temperature		
• during operating	-40 ... +80 °C	-40 ... +80 °C
• during storage	-40 ... +80 °C	-40 ... +80 °C
• during transport	-40 ... +80 °C	-40 ... +80 °C
• during installation	-20 ... +80 °C	-20 ... +80 °C
Ambient condition for (standard) operation mode	Transfer rate of cable: 31.25 Kbit/s	Transfer rate of cable: 31.25 Kbit/s
Protection class IP	-	-
Burning behaviour	flame resistant according to IEC 60332-3-24 (Category C)	flame resistant according to IEC 60332-3-24 (Category C)
Chemical resistance		
• to mineral oil	Conditional resistance	Conditional resistance
• to grease	Conditional resistance	Conditional resistance
• to water	Conditional resistance	Conditional resistance
Radiological resistance to UV radiation	Resistant	Resistant
Product properties, functions, components general		
Product feature		
• halogen-free	No	No
• silicon-free	Yes	Yes
Standards, specifications, approvals		
UL/ETL listing with 300 V rating	Yes: c(UL)us, CMG / CL3 / Sun Res	Yes: c(UL)us, CMG / CL3 / Sun Res
UL/ETL style with 600 V rating		
Verification of suitability		
• CE mark	Yes	Yes
• UL-registration	-	-
• RoHS conformity	Yes	Yes

Ordering data

Article No.	
PROFIBUS FC Process Cable	
2-core, shielded	
• Blue for Ex applications	6XV1830-5EH10
• Black for non-Ex applications	6XV1830-5FH10
Sold by the meter: Max. quantity 1 000 m; minimum order 20 m	
PROFIBUS FastConnect Stripping Tool	6GK1905-6AA00
Stripping tool for fast stripping of the PROFIBUS FastConnect bus cable	
PROFIBUS FastConnect Blade Cassettes	6GK1905-6AB00
Spare blade cassettes for PROFIBUS FastConnect stripping tool, 5 units	
SIMATIC NET Manual Collection	6GK1975-1AA00-3AA0
Electronic manuals for communication systems, communication protocols, and communication products; on DVD; German/English	

More information

Installation instruction

FastConnect

The FastConnect stripping tool can be used to strip the outer sheath and shield of the FC Process Cable to the required lengths for PROFIBUS PA.

Thus the use of the FastConnect stripping tool and SplitConnect tap permits the easy connection of field devices to, for example, the PROFIBUS PA bus system.

Cable routing

During storage, transport and cable laying, keep both ends sealed with a shrink-on cap.

Comply with the permissible bending radii and tensile load!

Note:

You can order components supplementary to the SIMATIC NET cabling range from your local contact.

Technical advice on this subject is available from:

J. Hertlein
 I IA SC CI PRM 4
 Phone: +49 (911) 750-4465
 E-mail: juergen.hertlein@siemens.com

PROFIBUS

Electrical networks (PROFIBUS PA)

Active field distributors

Overview

Active field distributor (AFD)

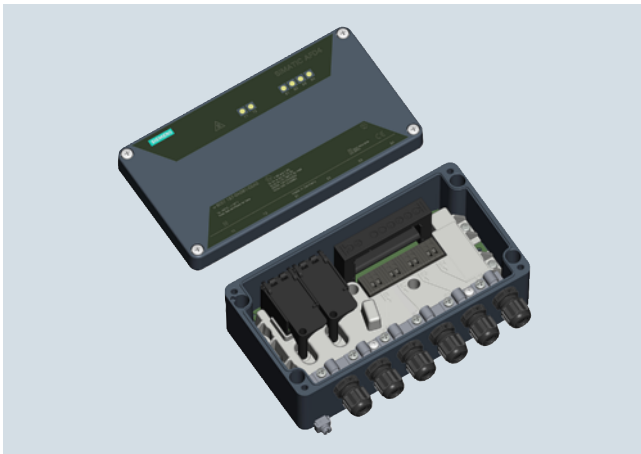

Active field distributor AFD4

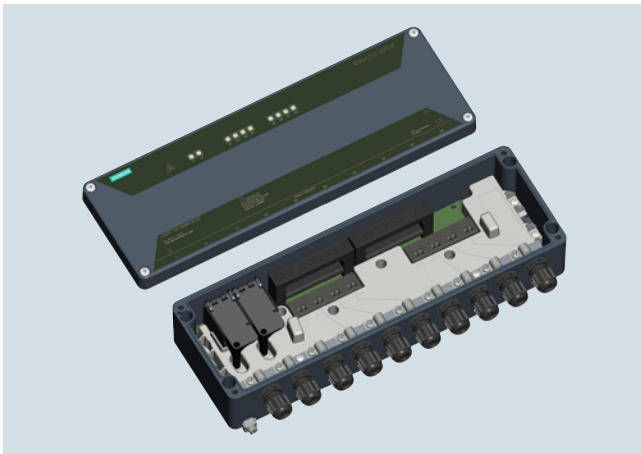

Active field distributor AFD8

Active field distributors (AFD) can be operated in environments in accordance with Ex zone 2/22. They are offered in two versions which differ as follows:

- AFD4 with 4 spur line connections for 1 field device each
- AFD8 with 8 spur line connections for 1 field device each

An AFD4 can therefore connect up to 4 field devices, and an AFD8 can connect up to 8 field devices, via short-circuit proof spur line connections to a fieldbus segment (line/ring) with automatic bus termination. This applies to both PA (PROFIBUS PA) as well as FF (FOUNDATION Fieldbus H1) field devices.

The fieldbus segment can be connected to a single or redundant PROFIBUS DP via a PA or FF router and can thus be seamlessly integrated into the SIMATIC PCS 7 process control system.

Up to 8 active field distributors AFD4/AFD8 with a total of up to 31 connected field devices can be operated per fieldbus segment. The number of field devices is also limited by the current consumption of the field devices. A maximum of 60 mA per spur line and a maximum of 1 A per segment is available for the field devices.

An AFD in a ring segment can be replaced during operation without failure of the segment.

For compliance with IP66 protection, it is necessary to protect unused spur line connections by plugs.

Overview (continued)

Active field distributor AFDiS

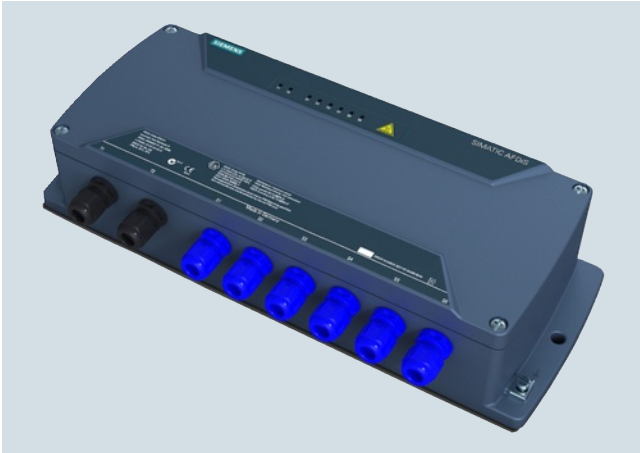

Active field distributor AFDiS

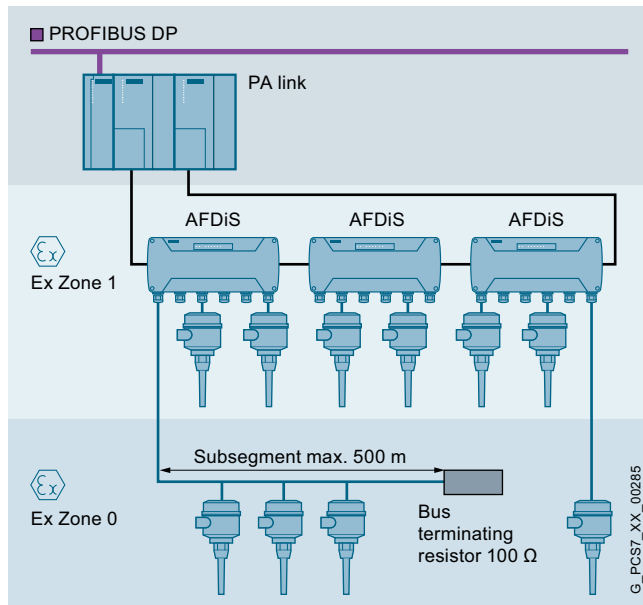

The active field distributor AFDiS (Active Field Distributor intrinsically Safe) can be operated in environments in accordance with Ex zone 1/21 and 2/22. It can integrate up to 6 intrinsically-safe PA or FF field devices into a fieldbus segment (line/ring) via its intrinsically-safe, short-circuit-proof spur line connections. Instead of the spur line, it is also possible to use a subsegment for 3 to 4 devices with a max. length of 500 m at connection S1 of the AFDiS. The spur lines with type of protection Ex [ia] as well as the subsegment can be routed into Zone 0/20.

Up to 5 field distributors AFDiS with a total of up to 31 field devices can be operated in a fieldbus segment. The limitation to 5 field distributors is also mandatory for mixed operation of AFD and AFDiS.

The number of field devices per segment additionally depends on the current consumption of the devices. A current of 1 A is available for all field devices of the segment.

With the integrated repeater function, the AFDiS has the following advantages compared to the AFD:

- Spur line lengths are independent of the total number of spur lines in the bus segment
- Spur line lengths need not be taken into account when determining the total length of the bus segment

Under the following conditions, an AFDiS in a ring segment can be replaced during operation without failure of the segment: Installation in Zone 2/22 or in a non-hazardous area.

For compliance with IP66 protection, it is necessary to protect unused spur line connections by plugs.

Active field splitter AFS

The active field splitter (AFS) connects a PA or FF line segment with a redundant coupler pair of a PA or FF router. The AFS interconnects the line segment with the respective active coupler.

The PA or FF line segment can be connected to the AFS via one or two (center feed) identical Y-connectors out of a total of 4. For the center feed, the line segment is connected via the two Y-connectors (bus termination switch on both FDC 157 couplers set to "OFF").

For compliance with IP66 protection, it is necessary to protect unused connections by plugs.

PROFIBUS

Electrical networks (PROFIBUS PA)

Active field distributors

Technical specifications

Active field distributor (AFD)		Active field distributor (AFD)	
General data		Connections, interfaces	
Connection of field devices	<ul style="list-style-type: none"> Standard-compliant field devices for PROFIBUS PA or FOUNDATION Fieldbus H1 Max. 4 per AFD4 Max. 8 per AFD8 Max. 31 per fieldbus segment Operating environment up to Zone 2 oder 22; Class I Zone 2/ Division 2 The max. current consumption of all fieldbus components of the fieldbus segment is 1 A 	<u>Main line</u>	
Degree of protection	IP66	Number of connections	2
Voltages, currents, potentials		Interfaces	PROFIBUS PA and FOUNDATION Fieldbus H1
Power supply	Via bus, no auxiliary power necessary	Automatic bus terminator	Yes
Rated supply voltage, permissible range	16 ... 32 V DC	<u>Spur cables</u>	
Reverse polarity protection (together with FDC 157)	Yes	Number of connections	
Oversvoltage protection	No	• AFD4	4
Current consumption		• AFD8	8
• Current consumption at idle	AFD4: 24 mA AFD8: 34 mA	Short-circuit-proof	Yes
• Current consumption with connected field devices	AFD4: 24 mA + total current of all field devices AFD8: 34 mA + total current of all field devices 30 mA	Intrinsically-safe acc. to FISCO	No
• Additional current consumption of the AFD at end of line (an open main line connection)		Current I_{max} (DC) on spur lines 1 to 4 (AFD4) or 1 to 8 (AFD8)	60 mA
• Current consumption at max. power output per spur line	AFD4: 264 mA AFD8: 514 mA	Short-circuit current (test current)	6 mA
Power loss	AFD4: Min. 384 mW; max. 3.2 W AFD8: Min. 544 mW; max. 4.1 W	Debounce logic	Yes
Grounding	Direct, via grounding rail	No-load voltage	< 30 V
Electrical isolation between main line and spur lines	No	Current output to field devices	
		• AFD4	Max. 240 mA
		• AFD8	Max. 480 mA
		Status, interrupts, diagnostics	
		Status indicator	Yes
		Diagnostics function	Yes
		Diagnostics LED	Yes
		Interrupts	No
		Climatic conditions	
		Permissible operating temperature	-40 ... +70 °C
		Permissible storage/transport temperature	-40 ... +85 °C
		Relative humidity during operation	Max. 95 %
		Approvals for potentially explosive atmospheres	
		• Gas	Zone 2
		• Dust	Zone 22
		Dimensions and weight	
		Dimensions (W x H x D) in mm (without fittings)	
		• AFD4	220 x 120 x 83
		• AFD8	360 x 120 x 83
		Weight	
		• AFD4	2 000 g
		• AFD8	3 000 g

Technical specifications (continued)

Active field distributor AFDiS		Active field distributor AFDiS	
General data		Status, interrupts, diagnostics	
Connection of field devices	<ul style="list-style-type: none"> Standard-compliant field devices for PROFIBUS PA or FOUNDATION Fieldbus H1 Max. 6 per AFDiS Max. 31 per fieldbus segment Operating environment up to Zone 1 oder 21; Class I Zone 1 The max. current consumption of all fieldbus components of the fieldbus segment is 1 A 	Status indicator	Yes
Degree of protection	IP66	Diagnostics function	Yes
Voltages, currents, potentials		Diagnostics LED	Yes
Power supply	Via bus, no auxiliary power necessary	Interrupts	No
Rated supply voltage, permissible range	16 ... 32 V DC	Climatic conditions	
Reverse polarity protection (together with FDC 157)	Yes; up to 1 A	Permissible operating temperature	-40 ... +70 °C
Overvoltage protection	No	Permissible storage/transport temperature	-40 ... +85 °C
Current consumption		Relative humidity during operation	Max. 95 %
• At 28 V input voltage	≤ 64 mA + (0.838 x aggregate current of all field devices)	Approvals for potentially explosive atmospheres	
• At 24 V input voltage	≤ 67 mA + (1.008 x aggregate current of all field devices)	• Gas	Zone 1 and Zone 2
• At 20 V input voltage	≤ 74 mA + (1.246 x aggregate current of all field devices)	• Dust	Zone 21 and Zone 22
Power loss	Min. 1.4 W; max. 5.9 W	Dimensions and weight	
Grounding	Direct, via connecting bar	Dimensions (W x H x D) in mm	380 x 85 x 170
Electrical isolation between main line and spur lines	Yes	Weight	4 500 g
Test voltage	2550 V DC, 2 s		
Connections, interfaces			
<u>Main line</u>			
Number of connections	2		
Interfaces	PROFIBUS PA and FOUNDATION Fieldbus H1		
Automatic bus terminator	Yes		
<u>Spur cables</u>			
Number of connections	6		
Short-circuit-proof	Yes		
Intrinsically-safe acc. to FISCO	Yes		
Current I_{max}			
• on spur line S1	60 mA		
• on spur line S2 to S6	40 mA		
• in total for all field devices	180 mA		
Short-circuit current (test current)	5 mA		
Debounce logic	Yes		
No-load voltage	Max. 15.3 V		
Current output to field devices	Max. 260 mA		

PROFIBUS

Electrical networks (PROFIBUS PA)

Active field distributors

Technical specifications (continued)

Active field splitter AFS	
General data	
Connection of field devices	<ul style="list-style-type: none"> • 1 fieldbus segment with max. 31 field devices • Operating environment up to Zone 2 oder 22; Class I Zone 2/ Division 2 • The max. current consumption of all fieldbus components of the fieldbus segment is 1 A
Degree of protection	IP66
Voltages, currents, potentials	
Power supply	Via bus, no auxiliary power necessary
Rated supply voltage, permissible range	16 ... 32 V DC
Reverse polarity protection (together with FDC 157)	Yes
Overvoltage protection	No
Current consumption at idle	54 mA
Power loss	Min. 864 mW; max. 2.13 W
Output current for supplying all field devices of the fieldbus segment (for dimensioning the device configuration)	1 A
Grounding	Direct, via connecting bar
Connections, interfaces	
<u>Main lines to the FDC 157 couplers</u>	
Number of connections	2
Automatic bus terminator	No
Maximum permissible continuous main line current	1 A
<u>Y-connectors for fieldbus line segment</u>	
Number of connections	1 or 2 (with center feed)
Interfaces	PROFIBUS PA and FOUNDATION Fieldbus H1
Short-circuit proof (together with FDC 157)	Yes
Intrinsically-safe acc. to FISCO	No
Current I_{max} on Y (limited by FDC 157)	1 A
Debounce logic	No
Continuous output voltage	Max. 32 V
Current output to field devices	Max. 1 A
Status, interrupts, diagnostics	
Status indicator	Yes
Diagnostics function	Yes
Diagnostics LED	Yes
Interrupts	No
Climatic conditions	
Permissible operating temperature	-40 ... +70 °C
Permissible storage/transport temperature	-40 ... +85 °C
Relative humidity during operation	Max. 95 %
Approvals for potentially explosive atmospheres	
• Gas	Zone 2
• Dust	Zone 22
Dimensions and weight	
Dimensions (W x H x D) in mm (without fittings)	220 x 120 x 83
Weight	2 000 g

Ordering data

Article No.

Active field distributor (AFD)

For integration of standard-compliant PA or FF field devices

- AFD4 with 4 short-circuit-proof spur line connections for 1 field device each
- AFD8 with 8 short-circuit-proof spur line connections for 1 field device each

6ES7157-0AG81-0XA0

6ES7157-0AG82-0XA0

Active Field Distributor AFDiS (Active Field Distributor intrinsically safe)

with 6 short-circuit-proof spur line connections for the integration of standard-compliant intrinsically-safe PA or FF field devices

6ES7157-0AG83-0XA0

Active field splitter (AFS)

for the interconnection of a bus line segment with the active coupler of a PA or FF router with redundant coupler pair

6ES7157-0AG80-0XA0

Accessories

Sealing plugs

for unused connections on AFS, AFD and AFDiS (10 units)

6ES7157-0AG80-1XA1

Overview

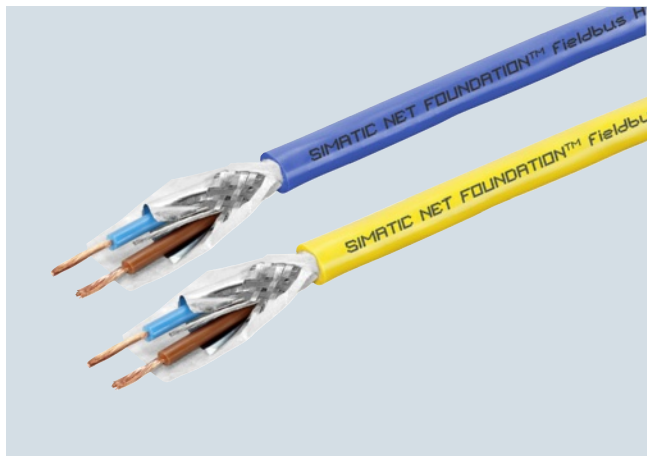

- Bus cable for fieldbus systems according to IEC 61158-2, e.g. FOUNDATION Fieldbus
- High noise immunity due to double shielding
- Different variants for different applications (hazardous, non-hazardous)

Benefits

get **Designed for Industry**

- Easy length measurement with printed meter markers
- Reduction in number of types and parts thanks to uniform connection system for FOUNDATION Fieldbus
- Cable design with shield wire for easy shield contact at the end device

Application

For setting up fieldbus networks according to IEC 61158-2 (e.g. FOUNDATION Fieldbus), different color-coded cable types are available to suit different types of applications (hazardous, non-hazardous areas).

UL approvals

Cable variants are available with appropriate UL approvals for laying in cable bundles and cable racks according to the specifications of NEC (National Electrical Code) Article 800/725.

Design

- Shielded, twisted-pair cable with circular cross-section
- Integrated grounding concept can be achieved with the outer shield of the bus cable
- Printed meter marks.

Cable types

- FOUNDATION Fieldbus cable:
Special bus cable compliant with IEC 61158-2 for use in hazardous and non-hazardous areas.
- Bus segments with RS485 and IEC 61158-2 transmission procedures are linked by the segment SIMATIC FF Link.

PROFIBUS**Electrical networks (FOUNDATION Fieldbus)****Bus cables****Technical specifications**

Article No.	6XV1830-5HH10	6XV1830-5GH10
Product-type designation	Foundation Fieldbus Cable	Foundation Fieldbus Cable
Product description	Bus cable (2-core), sold by the meter, in bulk	Bus cable (2-core), sold by the meter, in bulk
Acceptability for application	For use in fieldbus systems according to IEC 61158-2 (e.g. Foundation Fieldbus), suitable for non-Ex applications	For use in fieldbus systems according to IEC 61158-2 (e.g. Foundation Fieldbus), suitable for Ex applications
Cable designation	2X(ST)CY 1X2X1.1/2.85-100 LI GE FR OE	2X(ST)CY 1X2X1.1/2.85-100 LI GE FR OE
Cable length	-	-
Electrical data		
Damping ratio per length		
• at 9.6 kHz maximum	-	-
• at 38.4 kHz maximum	0.003 dB/m	0.003 dB/m
• at 4 MHz maximum	-	-
• at 16 MHz maximum	-	-
Impedance		
• Nominal value	100 Ω	100 Ω
• at 9.6 kHz	-	-
• at 38.4 kHz	100 Ω	100 Ω
• for frequency range 3 MHz ... 20 MHz	-	-
Relative symmetrical tolerance		
• of the surge impedance at 9.6 kHz	-	-
• of the surge impedance at 38.4 kHz	20 %	20 %
• of the surge impedance at 3 MHz ... 20 MHz	-	-
Loop resistance per length maximum	46 Ω/km	46 Ω/km
Shield resistance per length maximum	10 Ω/km	10 Ω/km
Capacity per length at 1 kHz	65 pF/m	65 pF/m
Operating voltage RMS value	300 V	300 V
Mechanical data		
Number of electrical wires	2	2
Design of shield	Overlapped aluminum-clad foil, sheathed in a braided shield of tin-plated copper wires with shield wire	Overlapped aluminum-clad foil, sheathed in a braided shield of tin-plated copper wires with shield wire
Design of the electrical connection FastConnect	No	No
Outer diameter		
• of the inner conductor	1.17 mm	1.17 mm
• of the wire insulation	2.85 mm	2.85 mm
• of the inner sheath of the cable	6.4 mm	6.4 mm
• of the cable sheath	8.5 mm	8.5 mm
Symmetrical tolerance of outer diameter of cable sheath	0.3 mm	0.3 mm
Outer diameter of the cable sheath Note	-	-
Material		
• of the wire insulation	PE	PE
• of the inner sheath of the cable	-	-
• of the cable sheath	PVC	PVC
- Note	-	-
Color		
• of the insulation of data wires	blue / brown	blue / brown
• of the cable sheath	Yellow	Blue
Bending radius		
• with single bend	34 mm	34 mm
• with multiple bends	68 mm	68 mm
• with continuous bending	-	-
Number of bending cycles	-	-
• Note	-	-
Number of torsion cycles with torsion by ± 180° on 1 m cable length	-	-
Traction stress maximum	100 N	100 N
Weight per length	98 kg/km	98 kg/km

Technical specifications (continued)

Article No.	6XV1830-5HH10	6XV1830-5GH10
Product-type designation	Foundation Fieldbus Cable	Foundation Fieldbus Cable
Permitted ambient conditions		
Ambient temperature		
• during operating	-40 ... +105 °C	-40 ... +105 °C
• during storage	-40 ... +105 °C	-40 ... +105 °C
• during transport	-40 ... +105 °C	-40 ... +105 °C
• during installation	-40 ... +105 °C	-40 ... +105 °C
Ambient condition for (standard) operation mode	Transfer rate of cable: 31.25 Kbit/s	Transfer rate of cable: 31.25 Kbit/s
Protection class IP	-	-
Burning behaviour	flame resistant according to IEC 60332-1-2	flame resistant according to IEC 60332-1-2
Chemical resistance		
• to mineral oil	Conditional resistance	Conditional resistance
• to grease	Conditional resistance	Conditional resistance
• to water	Conditional resistance	Conditional resistance
Radiological resistance to UV radiation	Resistant	Resistant
Product properties, functions, components general		
Product feature		
• halogen-free	No	No
• silicon-free	Yes	Yes
Cable length		
• at max. 12 Mbit/s	-	-
• at max. 1.5 Mbit/s	-	-
Standards, specifications, approvals		
UL/ETL listing with 300 V rating	Yes: c(UL)us, CMG / PLTC / Sun Res	Yes: c(UL)us, CMG / PLTC / Sun Res
UL/ETL style with 600 V rating	No	No
Verification of suitability		
• CE mark	-	-
• UL-registration	-	-
• RoHS conformity	Yes	Yes
Marine classification association		
• Germanische Lloyd (GL)	No	No
• Lloyds Register of Shipping (LRS)	No	No

Ordering data
FOUNDATION Fieldbus Cable

- 2-core, shielded
- Blue for Ex applications
- Orange for non-hazardous applications

Sold by the meter:
 Max. quantity 1 000 m,
 minimum order 20 m

Article No.

6XV1830-5GH10
6XV1830-5HH10

More information
Cable routing

During storage, transport and cable laying, keep both ends sealed with a shrink-on cap.

Comply with the permissible bending radii and tensile load!

Note:

You can order components supplementary to the SIMATIC NET cabling range from your local contact.

Technical advice on this subject is available from:

J. Hertlein
 I IA SC CI PRM 4
 Phone: +49 (911) 750-4465
 E-mail: juergen.hertlein@siemens.com

PROFIBUS

Optical networks with OLM

Overview of FC-FOCs

Overview

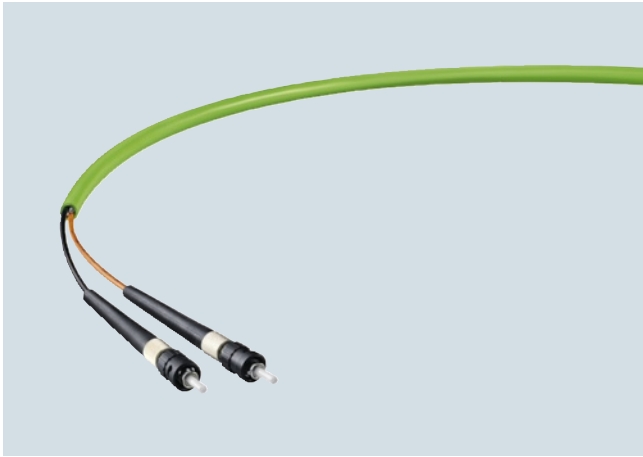

- Simple on-site assembly of glass FOC in the field
- Optical signal transmission
- No radiation emission from the cable
- Unaffected by external noise fields
- No grounding problems
- Electrical isolation
- Low weight
- Simple laying of cables

Design

Fiber-optic cables with glass core (62.5/200/230) are offered for the FastConnect fiber-optic cable system:

- FC glass fiber-optic cable; duplex cable for indoor and outdoor fiber-optic networks

The fiber structure corresponds to that of the PCF. This allows simple assembly on site.

Sheath material	Application
PVC	Standard use in indoor and outdoor areas of industrial applications
PUR	Highly mobile applications (tow chains) for high mechanical or chemical stress in harsh industrial environments
PE	Routing of cables in moist areas indoors and outdoors, and for direct burying in earth
FRNC	Standard applications with high fire protection requirements

Approvals

UL listing (safety standard) for network lines is especially necessary for the American and Canadian markets. The requirements for the appropriate approvals depend on where the cable is routed within the building. This applies to all cables which have to be routed from a machine to a remote control cabinet and are positioned on cable racks secured in the building. These cables are identified by the suffix "GP" (general purpose) in the product name and have the corresponding UL approvals.

Application

The fiber-optic cable (FOC) is used for the transmission of signals in very extensive plants and where there are significant potential differences within a plant. The light beam is guided by total reflection at the transition from core to cladding which has a lower refractive index than the core.

The FastConnect fiber-optic (FC FO) system enables fast on-site assembly of glass fiber-optic cables with the right lengths to suit the respective application.

Assembly with FastConnect for glass fiber-optic cables

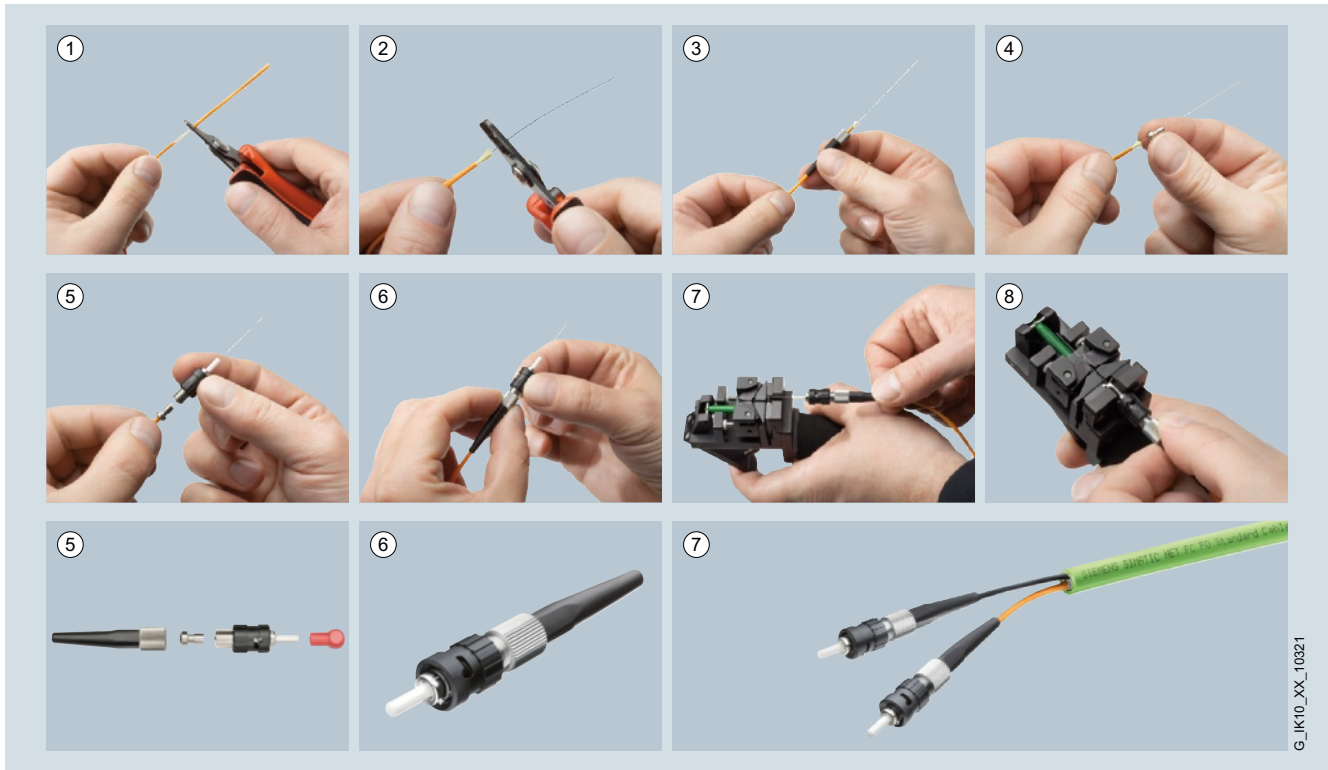

Steps for assembly of Industrial Ethernet fiber-optic cables with Industrial Ethernet FastConnect

PROFIBUS

Optical networks with OLM

FC glass fiber-optic cables

Overview



- FastConnect standard fiber-optic cable for use in optical Industrial Ethernet and PROFIBUS networks
- For all users who want to install and assemble the glass fiber-optic cables themselves over longer distances on site for office or industrial applications.
- Simple FastConnect SC/BFOC connector assembly on site
- Rugged construction for industrial applications both indoors and outdoors
- High interference immunity, as they are not sensitive to electromagnetic interference
- Extensive range of approvals (UL approvals)

Benefits



- Avoidance of excessive cable lengths in the control cabinet, as the fiber-optic cables can be assembled to the right length on site
- Easy installation of cables in buildings, as cables can be pulled in without connectors attached
- Simple extension of installed glass fiber-optic cables via SC and BFOC couplers
- Devices with different connection method (SC or BFOC) can easily be connected to one another using self-assembled adapter cables
- Electrical isolation of Industrial Ethernet/PROFINET/PROFIBUS devices
- Unaffected by electromagnetic interference
- Tap-proof: no radiation from cable

Application

SIMATIC NET FastConnect glass fiber-optic cables are used to construct optical indoor and outdoor Industrial Ethernet/PROFINET and PROFIBUS networks. Devices with integral optical interface (SC or BFOC connection technology) are, for example, optical link modules (OLM) and SCALANCE X Industrial Ethernet switches.

FastConnect glass fiber-optic cables are to be assembled on site using FastConnect SC or FastConnect BFOC connectors. A corresponding assembly kit (FC FO Termination Kit) is available for this purpose. The Termination Kit permits the stripping and the "cleaving" of the fiber in the assembled connector, as is familiar from PCF fiber-optic cables. To extend existing lines, a BFOC or SC coupler may be used depending on the connection technology.

Design

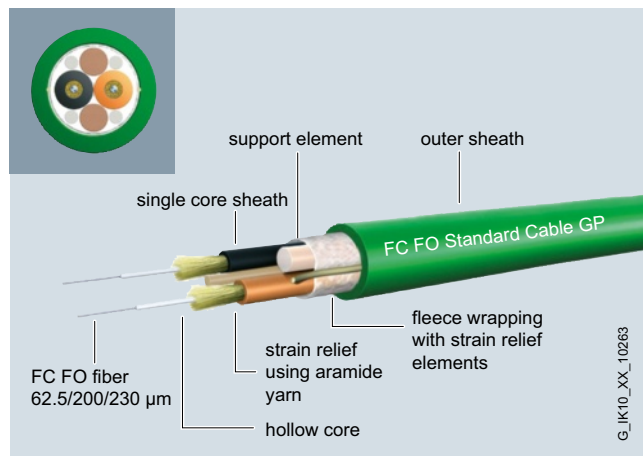

FC FO Standard Cable GP (General Purpose); rugged round cable with green outer sheath, Kevlar strain relief elements, and 62.5/200/230 FC FO fibers for indoor/outdoor applications

FC FO Trailing Cable; rugged round cable with green outer sheath, Kevlar strain relief elements and 62.5/200/230 FC FO fibers for use in tow chains and moving applications

Maximum cable length between two devices:

- 3 000 m for 100 Mbit/s Ethernet or for PROFIBUS
- 350 m for 1 000 Mbit/s Ethernet (1000Base-SX)
- 550 m for 1 000 Mbit/s Ethernet (1000Base-LX)

The maximum cable lengths can be assembled from partial lengths using FastConnect couplings (SC or BFOC; maximum two couplings, approx. 2.5 dB attenuation per coupling). It is also possible to combine existing installed, conventional 62.5/125 μm multimode glass fiber-optic cable sections with the FastConnect fiber-optic cables.

G_JK10_XX_10263

Technical specifications

Article No.	6XV1847-2A	6XV1847-2C
Product-type designation	FC FO standard cable GP	FC FO trailing cable
Product description	Glass fiber-optic cable for assembly in the field, sold by the meter, unassembled	Flexible glass fiber-optic cable for assembly in the field, sold by the meter, unassembled
Acceptability for application	Cable for fixed routing in cable ducts and conduits, UL approval	Cable for high mechanical loading for use in trailing cables indoors and outdoors
Version of the assembled FO cable	Can be fitted with four BFOC or SC connectors	Can be fitted with four BFOC or SC connectors
Cable designation	AT-V(ZN)YY 2GK 62.5/200/230	AT-V(ZN)Y(ZN)11Y 2GK 62.5/200/230
Cable length	-	-
Optical data		
Damping ratio per length		
• at 850 nm maximum	3.2 dB/km	3.2 dB/km
• at 1300 nm maximum	0.9 dB/km	0.9 dB/km
• at 1550 nm maximum	-	-
Bandwidth length product		
• at 850 nm	200 GHz·m	200 GHz·m
• at 1300 nm	500 GHz·m	500 GHz·m
Mechanical data		
Number of fibers per FOC core	1	1
Number of FOC cores per FOC cable	2	2
Version of the FO conductor fiber	Multi-mode gradient fiber 62.5/200/230 µm	Multi-mode gradient fiber 62.5/200/230 µm
Design of the FOC core	Fixed core	Fixed core
Design of the fiber-optic cable	Segmentable cable	Segmentable cable
Outer diameter		
• of optical fibers	62.5 µm	62.5 µm
• of the optical fiber sheath	230 µm	230 µm
• of the FOC core sheath	2.2 mm	2.2 mm
• of the cable	7.2 mm	8.8 mm
Symmetrical deviation		
• of the outer diameter of the FOC core sheath	0.1 mm	0.1 mm
• of the outer diameter of the line	0.5 mm	0.5 mm
Width of the cable sheath	-	-
Symmetrical tolerance of width of cable sheath	-	-
Thickness of the cable sheath	-	-
Symmetrical tolerance of thickness of cable sheath	-	-
Material		
• of the fiber-optic cable core	Quartz glass	Quartz glass
• of the optical fiber sheath	ETFE	ETFE
• of the FOC core sheath	PVC	PVC
• of the fiber-optic cable sheath	PVC	PUR
• of the strain relief	Aramide fibers	Aramide fibers (double-ply)
Color		
• of the FOC core sheath	Orange/black	Orange/black
• of the cable sheath	green	green
Bending radius		
• with single bend minimum permissible	70 mm	88 mm
• with multiple bends minimum permissible	105 mm	88 mm
• with continuous bending	-	88 mm
Number of bending cycles	-	5 000 000
Number of torsion cycles in the case of torsion by ± 360° on 1 m cable length	-	-
Traction stress maximum	100 N	800 N
Short-term shear force per length	500 N/cm	500 N/cm
Continuous lateral force per length	300 N/cm	300 N/cm
Weight per length	49 kg/km	65 kg/km

PROFIBUS

Optical networks with OLM

FC glass fiber-optic cables

Technical specifications (continued)

Article No.	6XV1847-2A	6XV1847-2C
Product-type designation	FC FO standard cable GP	FC FO trailing cable
Permitted ambient conditions		
Ambient temperature		
• during operating	-40 ... +85 °C	-25 ... +75 °C
• during storage	-40 ... +85 °C	-30 ... +75 °C
• during transport	-40 ... +85 °C	-30 ... +75 °C
• during installation	-5 ... +50 °C	-5 ... +50 °C
Ambient condition for (standard) operation mode	-	-
Protection class IP	-	-
Burning behaviour	flame resistant according to IEC 60332-1-2 and IEC 60332-3-22 (Cat. A)	flame resistant according to IEC 60332-1-2
Chemical resistance		
• to mineral oil	Conditional resistance	resistant
• to grease	Conditional resistance	resistant
• to water	Conditional resistance	Conditional resistance
Radiological resistance to UV radiation	resistant	resistant
Product properties, functions, components general		
Product feature		
• halogen-free	No	No
• silicon-free	Yes	Yes
Product component Rodent protection	No	No
Cable length for glass FOC		
• for 100BaseFX for Industrial Ethernet maximum	3 000 m	3 000 m
• for 1000BaseSX for Industrial Ethernet maximum	350 m	350 m
• for 1000BaseLX for Industrial Ethernet maximum	550 m	550 m
• for PROFIBUS maximum	3 000 m	3 000 m
Standards, specifications, approvals		
Verification of suitability	UL approval: OFN (NEC Article 770, UL 1651) / CSA approval: OFN 90 Cel, FT1, FT4 (CSA Standard C22.2 No 232-M1988)	-
• RoHS conformity	Yes	Yes
Marine classification association		
• Bureau Veritas (BV)	-	-
• Germanische Lloyd (GL)	-	-
• Lloyds Register of Shipping (LRS)	-	-

Technical specifications (continued)

Article No.	6GK1900-1LB00-0AC0	6GK1900-1GB00-0AC0	6GK1900-1LP00-0AB0	6GK1900-1GP00-0AB0
Product-type designation	IE SC RJ PCF Plug PRO (Push Pull)	FC FO BFOC Plug	FC FO SC Coupler	FC FO BFOC Coupler
Product description	SC plug for FastConnect assembly	BFOC plug for FastConnect assembly	FC coupler for FastConnect assembly	BFOC coupler for FastConnect assembly
Acceptability for application	For connecting glass fiber-optic cables, suitable for fast assembly with the FastConnect FO system	For connecting glass fiber-optic cables, suitable for fast assembly with the FastConnect FO system	-	-
Transmission rate				
Transfer rate				
• 1 for Industrial Ethernet	10 Mbit/s	10 Mbit/s	10 Mbit/s	10 Mbit/s
• 2 for Industrial Ethernet	100 Mbit/s	100 Mbit/s	100 Mbit/s	100 Mbit/s
• 3 for Industrial Ethernet	1 000 Mbit/s	1 000 Mbit/s	1 000 Mbit/s	1 000 Mbit/s
• with PROFIBUS	9.6 kbit/s ... 12 Mbit/s	9.6 kbit/s ... 12 Mbit/s	9.6 kbit/s ... 12 Mbit/s	9.6 kbit/s ... 12 Mbit/s
Interfaces				
Number of optical interfaces for optical waveguide	1	1	1	1
Design of optical connections for network components or terminal devices	SC connector	BFOC connector	SC duplex coupling	BFOC coupling
Design of the electrical connection FastConnect	Yes	Yes	Yes	Yes
Mechanical data				
Material of the enclosure	Metal and plastic	Metal and plastic	Metal and plastic	Metal and plastic
Design, dimensions and weight				
Type of cable outlet	180 degree cable outlet	180 degree cable outlet	180 degree cable outlet	180 degree cable outlet
Width	8 mm	10 mm	9 mm	11 mm
Height	8 mm	10 mm	35 mm	11 mm
Depth	49 mm	22 mm	28 mm	29.5 mm
Net weight	11 g	9 g	18 g	9 g
Permitted ambient conditions				
Ambient temperature				
• during operating	-40 ... +85 °C	-40 ... +85 °C	-40 ... +85 °C	-40 ... +85 °C
• during storage	-40 ... +85 °C	-40 ... +85 °C	-40 ... +85 °C	-40 ... +85 °C
• during transport	-40 ... +85 °C	-40 ... +85 °C	-40 ... +85 °C	-40 ... +85 °C
Relative humidity at 25 °C without condensation during operating maximum	95 %	95 %	95 %	95 %
Protection class IP	IP20	IP20	IP20	IP20
Chemical resistance to water	-	-	-	-
Product properties, functions, components general				
Product feature silicon-free	Yes	Yes	Yes	Yes
Product component strain relief	Yes	Yes	Yes	Yes
Standards, specifications, approvals				
Verification of suitability RoHS conformity	Yes	Yes	Yes	Yes

PROFIBUS

Optical networks with OLM

FC glass fiber-optic cables

Ordering data	Article No.
FC FO standard cable GP 62.5/200/230 FC FO standard cable for fixed routing indoors with PVC sheath; sold by the meter max. length 1 000 m; minimum order 20 m	6XV1847-2A
FC FO trailing cable FC FO trailing cable for use in tow chains and moving applications; sold by the meter	6XV1847-2C
FC FO termination kit Assembly case for local assembly of FC SC and FC BFOC connectors to FC FO standard cable, comprising a stripping tool, Kevlar cutters, fiber breaking tool and microscope	6GK1900-1GL00-0AA0
FC SC plug Screw connector for on-site assembly on FC fiber-optic cable; (1 pack = 10 duplex plugs + cleaning cloths)	6GK1900-1LB00-0AC0
FC BFOC plug Screw connector for on-site assembly on FC fiber-optic cable; (1 pack = 20 units + cleaning cloths)	6GK1900-1GB00-0AC0
FC SC coupler FC SC duplex coupling; (1 pack = 5 units)	6GK1900-1LP00-0AB0
FC BFOC coupler FC BFOC coupling; (1 pack = 10 units)	6GK1900-1GP00-0AB0
SIMATIC NET Manual Collection Electronic manuals for communication systems, communication protocols, and communication products; on DVD; German/English	6GK1975-1AA00-3AA0

More information

You can order components supplementary to the SIMATIC NET cabling range from your local contact.

Technical advice on this subject is available from:

J. Hertlein
 I IA SC CI PRM 4
 Phone: +49 (911) 750-4465
 E-mail: juergen.hertlein@siemens.com

Overview



- Compact, rugged assembly case for FastConnect glass fiber-optic cables
- Simple fitting of SC and BFOC connectors to FastConnect glass fiber-optic cables
- The quality of the assembly can be checked using the enclosed microscope

Benefits



- Simple installation of the unassembled cable
- Flexible connector assembly possible on site (SC/BFOC connectors)
- Prevention of faults by simply checking the assembled connectors using a microscope
- Simple repair of FC glass fiber-optic cables in the field

Application

SIMATIC NET FC glass fiber-optic cables are used to construct optical indoor and outdoor Industrial Ethernet/PROFINET and PROFIBUS networks. They are easy to assemble on-site using the termination kit with SC or BFOC connectors. The maximum cable length between two Industrial Ethernet/PROFINET or PROFIBUS devices is 3000 m in the case of 100 Mbit/s Ethernet or PROFIBUS.

Design

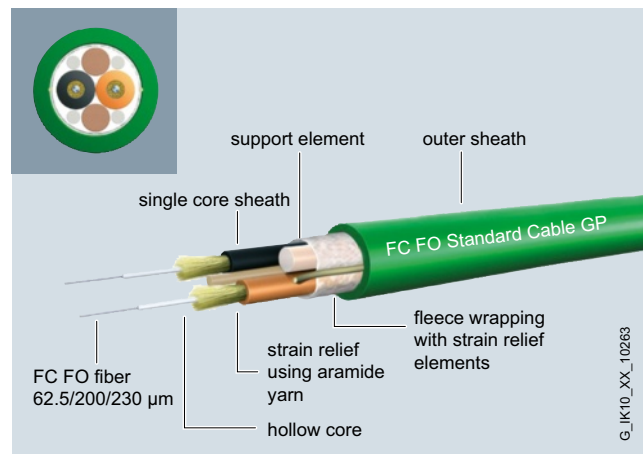

Cable construction FC glass optical fiber

The kit is available in an assembly case for on-site installation of FC SC and FC BFOC connectors on FC glass fiber-optic cables.

It consists of a stripping tool, buffer stripping tool, Kevlar scissors, fiber breaking tool and microscope.

Ordering data

Article No.

FC FO termination kit

Assembly case for local assembly of FC SC and FC BFOC connectors to FC FO standard cable, comprising a stripping tool, Kevlar cutters, fiber breaking tool and microscope

6GK1900-1GL00-0AA0

More information

You can order components supplementary to the SIMATIC NET cabling range from your local contact.

Technical advice on this subject is available from:

J. Hertlein
 I IA SC CI PRM 4
 Phone: +49 (911) 750-4465
 E-mail: juergen.hertlein@siemens.com

PROFIBUS

Optical networks with OLM

Glass fiber-optic cable

Overview



- Used for the optical Industrial Ethernet and PROFIBUS networks
- Rugged design for industrial applications indoors and outdoors
- Halogen-free design for installation inside buildings
- Trailing cable for the special application of forced motion control
- High immunity to noise thanks to insensitivity to electro-magnetic fields
- Available preassembled
- Extensive approvals (UL)

Benefits

get Designed for Industry

- Easy to lay with
 - preassembled cables
 - no grounding problems
 - very light fiber optic cable.
- Tap-proof, no radiation from the cable
- Silicon-free, therefore suitable for use in the automotive industry (e.g. in paintshops)
- Avoidance of overvoltage and equipotential bonding problems

Application

Marine duplex fiber-optic cable SIENOPYR

Halogen-free, non-crush, flame-retardant, marine-approved fiber-optic cable for permanent installation on ships and on off-shore platforms indoors and on open deck. Sold by the meter.

Fiber-optic indoor cable

Halogen-free fiber-optic cable, non-crush, flame-retardant, for installation inside buildings (e.g. in production halls and in building automation). Supplied in fixed lengths, pre-assembled with 4 BFOC connectors.

Standard FOC/FRNC cable

Fiber-optic cables for the following application areas indoors and outdoors

- For routing above ground
- For installation inside buildings.

Sold by the meter and in fixed lengths, pre-assembled with 4 BFOC connectors.

Fiber-optic trailing cable

Fiber-optic cables for the special application of forced motion control, such as in continuously moving machine parts (in trailing cables) indoors and outdoors. Two cable variants are available for this application:

- FO Trailing Cable; Cable for high mechanical stress, PUR outer sheath, no UL approval
- FO Trailing Cable GP (general purpose); Cable for low mechanical stress, PVC outer sheath, with UL approval

Sold by the meter and in fixed lengths, pre-assembled with 4 BFOC connectors.

Fiber-optic outdoor cable

Waterproof cable (lengthwise and sideways) for use outdoors with non-metallic protection against rodents for laying into the ground.

Sold by the meter and in fixed lengths, pre-assembled with 4 BFOC connectors.

Note:

Special tools and specially trained personnel are required for pre-assembling glass fiber-optic cables

Application (continued)

Application Examples

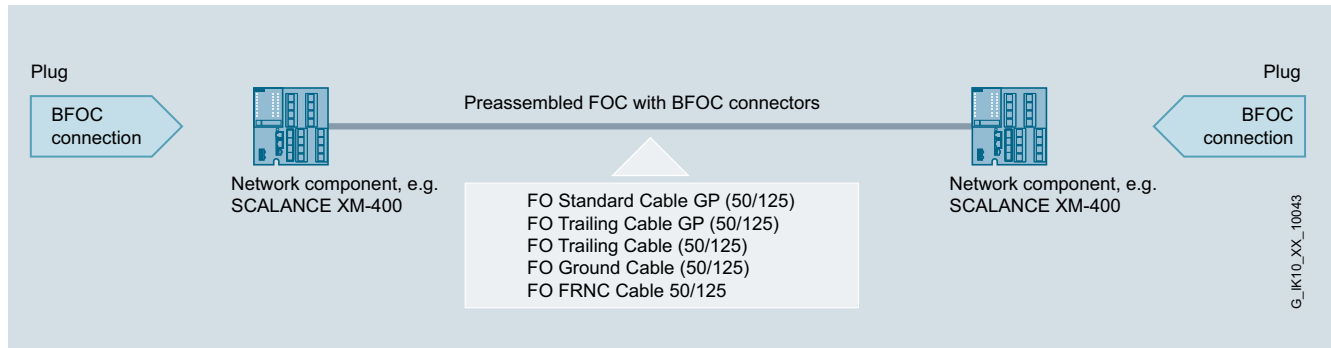

Use of pre-assembled fiber-optic cables with BFOC connectors (12 Mbit/s)

Design

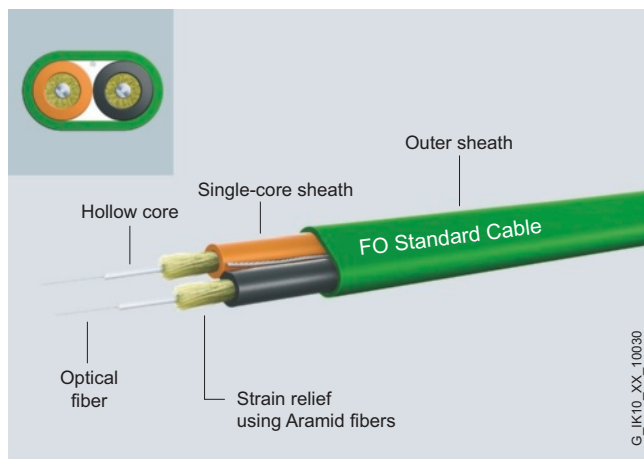

In order to span very long distances, the use of singlemode cables with a 9 μm fiber is recommended.

Cable types	50/125 μm	62.5/125 μm	9/125 μm
FO standard cable GP (50/125/1 400)	●	—	—
FO FRNC cable (50/125/1 400)	●	—	—
FO trailing cable (50/125/1 400)	●	—	—
FO trailing cable GP (50/125/1 400)	●	—	—
FO ground cable (50/125/1 400)	●	—	—
FO robust cable GP (50/125/900)	●	—	—
Fiber-optic standard cable (62.5/125/900)	—	●	—
INDOOR fiber-optic cable (62.5/125/900)	—	●	—
Flexible fiber-optic trailing cable (62.5/125/1400)	—	●	—
SIENOPYR marine duplex fiber-optic cable (62.5/125/900)	—	●	—
FO robust cable GP (4E9/125/900)	—	—	●

PROFIBUS

Optical networks with OLM

Glass fiber-optic cable

Technical specifications

Article No.	6XV1873-2A	6XV1873-2B	6XV1873-2G
Product-type designation	FO Standard Cable GP	FO FRNC Cable GP	FO Ground Cable
Product description	Glass fiber-optic cable, sold by the meter, unassembled	Glass fiber-optic cable, sold by the meter, unassembled	Glass fiber-optic cable, sold by the meter, unassembled
Acceptability for application	Cable for indoor and outdoor use, UL approval	Halogen-free cable for indoor and outdoor use, for fixed installation, UL approval	Cable with longitudinal and lateral water tightness with non-metallic protection against rodents for outdoor use and for direct laying in soil
Version of the assembled FO cable	Can be fitted with four BFOC or SC connectors	Can be fitted with four BFOC or SC connectors	Can be fitted with four BFOC or SC connectors
Cable designation	AT-W(ZN)YY 2x1 G 50/125	AT-W(ZN)HH 2G 50/125 UV	AT-WQ(ZN)Y(ZN)B2Y 2G 50/125
Cable length	-	-	-
Optical data			
Damping ratio per length			
• at 850 nm maximum	2.7 dB/km	2.7 dB/km	2.7 dB/km
• at 1300 nm maximum	0.7 dB/km	0.7 dB/km	0.7 dB/km
• at 1550 nm maximum	-	-	-
Bandwidth length product			
• at 850 nm	600 GHz·m	600 GHz·m	600 GHz·m
• at 1300 nm	1 200 GHz·m	1 200 GHz·m	1 200 GHz·m
Mechanical data			
Number of fibers per FOC core	1	1	1
Number of FOC cores per FOC cable	2	2	2
Version of the FO conductor fiber	Multi-mode gradient fiber 50/125 µm, OM 2	Multi-mode gradient fiber 50/125 µm, OM 2	Multi-mode gradient fiber 50/125 µm, OM 2
Design of the FOC core	Hollow core, filled, diameter 1 400 µm	Hollow core, filled, diameter 1 400 µm	Hollow core, filled, diameter 1 400 µm
Design of the fiber-optic cable	Segmentable	Segmentable	Segmentable
Outer diameter			
• of optical fibers	50 µm	50 µm	50 µm
• of the optical fiber sheath	125 µm	125 µm	125 µm
• of the FOC core sheath	2.9 mm	2.9 mm	2.9 mm
• of the cable	-	9.2 mm	10.5 mm
Symmetrical deviation			
• of the outer diameter of the FOC core sheath	0.1 mm	0.1 mm	0.1 mm
• of the outer diameter of the line	-	0.3 mm	0.5 mm
Width of the cable sheath	7.4 mm	-	-
Thickness of the cable sheath	4.5 mm	-	-
Material			
• of the fiber-optic cable core	Quartz glass	Quartz glass	Quartz glass
• of the optical fiber sheath	Quartz glass	Quartz glass	Quartz glass
• of the FOC core sheath	PVC	FRNC	PVC
• of the fiber-optic cable sheath	PVC	FRNC	PE
• of the strain relief	Aramide fibers	Aramide fibers	Aramide fibers
Color			
• of the FOC core sheath	Orange/black	Orange/black	Orange/black
• of the cable sheath	green	green	Black
Bending radius			
• with single bend minimum permissible	45 mm	90 mm	105 mm
• with multiple bends minimum permissible	65 mm	135 mm	155 mm
• with continuous bending	-	-	-
Number of bending cycles	-	-	-
Number of torsion cycles in the case of torsion by ± 360° on 1 m cable length	-	-	-
Traction stress maximum	500 N	500 N	800 N
Short-term shear force per length	600 N/cm	500 N/cm	500 N/cm
Continuous lateral force per length	400 N/cm	-	300 N/cm
Weight per length	40 kg/km	85 kg/km	90 kg/km

Technical specifications (continued)

Article No.	6XV1873-2A	6XV1873-2B	6XV1873-2G
Product-type designation	FO Standard Cable GP	FO FRNC Cable GP	FO Ground Cable
Permitted ambient conditions			
Ambient temperature			
• during operating	-25 ... +80 °C	-40 ... +85 °C	-40 ... +85 °C
• during storage	-25 ... +80 °C	-40 ... +85 °C	-40 ... +85 °C
• during transport	-25 ... +80 °C	-40 ... +85 °C	-40 ... +85 °C
• during installation	-5 ... +50 °C	-5 ... +50 °C	-5 ... +50 °C
Ambient condition for (standard) operation mode	-	-	-
Protection class IP	-	-	-
Burning behaviour	flame resistant according to IEC 60332-1-2 and IEC 60332-3-22 (Cat. A)	flame resistant according to IEC 60332-1-2 and IEC 60332-3-22 (Cat. A)	flammable
Chemical resistance			
• to mineral oil	Conditional resistance	Conditional resistance	resistant
• to grease	Conditional resistance	Conditional resistance	resistant
• to water	Conditional resistance	Conditional resistance	resistant
Radiological resistance to UV radiation	resistant	resistant	resistant
Product properties, functions, components general			
Product feature			
• halogen-free	No	Yes	No
• silicon-free	Yes	Yes	Yes
Product component Rodent protection	No	No	Yes
Cable length for glass FOC			
• for 100BaseFX for Industrial Ethernet maximum	5 000 m	5 000 m	5 000 m
• for 1000BaseSX for Industrial Ethernet maximum	750 m	750 m	750 m
• for 1000BaseLX for Industrial Ethernet maximum	2 000 m	2 000 m	2 000 m
• for PROFIBUS maximum	3 000 m	3 000 m	3 000 m
Standards, specifications, approvals			
Verification of suitability	UL approval: OFN (NEC Article 770, UL 1651) / CSA approval: OFN 90 Cel, FT1, FT4 (CSA standard C22.2 No 232-M1988)	UL approval: OFN (NEC Article 770, UL 1651) / CSA approval: OFN (CSA standard C22.2 No 232-M1988)	-
• RoHS conformity	Yes	Yes	Yes
Marine classification association			
• Bureau Veritas (BV)	-	-	-
• Germanische Lloyd (GL)	-	-	-
• Lloyds Register of Shipping (LRS)	-	-	-

PROFIBUS**Optical networks with OLM****Glass fiber-optic cable****Technical specifications (continued)**

Article No.	6XV1873-2C	6XV1873-2D
Product-type designation	FO Trailing Cable	FO Trailing Cable GP
Product description	Glass fiber-optic cable, sold by the meter, unassembled	Glass fiber-optic cable, sold by the meter, unassembled
Acceptability for application	Flexible cable for use in trailing cables with high mechanical stress, without UL approval	Flexible cable for use in trailing cables with high mechanical stress, UL approval
Version of the assembled FO cable	Can be fitted with four BFOC or SC connectors	Can be fitted with four BFOC or SC connectors
Cable designation	AT-W(ZN)Y(ZN)11Y 2G 50/125	AT-W(ZN)Y(ZN)Y 2G 50/125
Cable length	-	-
Optical data		
Damping ratio per length		
• at 850 nm maximum	2.7 dB/km	2.7 dB/km
• at 1300 nm maximum	0.7 dB/km	0.7 dB/km
• at 1550 nm maximum	-	-
Bandwidth length product		
• at 850 nm	600 GHz·m	600 GHz·m
• at 1300 nm	1 200 GHz·m	1 200 GHz·m
Mechanical data		
Number of fibers per FOC core	1	1
Number of FOC cores per FOC cable	2	2
Version of the FO conductor fiber	Multi-mode gradient fiber 50/125 µm, OM 2	Multi-mode gradient fiber 50/125 µm, OM 2
Design of the FOC core	Hollow core, filled, diameter 1 400 µm	Hollow core, filled, diameter 1 400 µm
Design of the fiber-optic cable	Segmentable	Segmentable
Outer diameter		
• of optical fibers	50 µm	50 µm
• of the optical fiber sheath	125 µm	125 µm
• of the FOC core sheath	2.9 mm	2.9 mm
• of the cable	10.5 mm	10.5 mm
Symmetrical deviation		
• of the outer diameter of the FOC core sheath	0.1 mm	0.1 mm
• of the outer diameter of the line	0.5 mm	0.5 mm
Material		
• of the fiber-optic cable core	Quartz glass	Quartz glass
• of the optical fiber sheath	Quartz glass	Quartz glass
• of the FOC core sheath	PVC	PVC
• of the fiber-optic cable sheath	PUR	PVC
• of the strain relief	Aramide fibers	Aramide fibers
Color		
• of the FOC core sheath	Orange/black	Orange/black
• of the cable sheath	green	green
Bending radius		
• with single bend minimum permissible	150 mm	150 mm
• with multiple bends minimum permissible	200 mm	200 mm
• with continuous bending	-	-
Number of bending cycles	5 000 000	3 500 000
Number of torsion cycles in the case of torsion by ± 360° on 1 m cable length	-	-
Traction stress maximum	800 N	800 N
Short-term shear force per length	700 N/cm	700 N/cm
Continuous lateral force per length	400 N/cm	400 N/cm
Weight per length	90 kg/km	90 kg/km

Technical specifications (continued)

Article No.	6XV1873-2C	6XV1873-2D
Product-type designation	FO Trailing Cable	FO Trailing Cable GP
Permitted ambient conditions		
Ambient temperature		
• during operating	-40 ... +80 °C	-25 ... +80 °C
• during storage	-40 ... +80 °C	-25 ... +80 °C
• during transport	-40 ... +80 °C	-25 ... +80 °C
• during installation	-5 ... +50 °C	-5 ... +50 °C
Ambient condition for (standard) operation mode	-	-
Protection class IP	-	-
Burning behaviour	flammable	flame resistant according to IEC 60332-1-2 and IEC 60332-3-22 (Cat. A)
Chemical resistance		
• to mineral oil	resistant	Conditional resistance
• to grease	resistant	Conditional resistance
• to water	Conditional resistance	Conditional resistance
Radiological resistance to UV radiation	resistant	resistant
Product properties, functions, components general		
Product feature		
• halogen-free	No	No
• silicon-free	Yes	Yes
Product component Rodent protection	No	No
Cable length for glass FOC		
• for 100BaseFX for Industrial Ethernet maximum	5 000 m	5 000 m
• for 1000BaseSX for Industrial Ethernet maximum	750 m	750 m
• for 1000BaseLX for Industrial Ethernet maximum	2 000 m	2 000 m
• for PROFIBUS maximum	3 000 m	3 000 m
Standards, specifications, approvals		
Verification of suitability	-	UL approval: OFN (NEC Article 770, UL 1651) / CSA approval: OFN 90 °C, FT1, FT4 (CSA standard C22.2 No. 232-M1988)
• RoHS conformity	Yes	Yes
Marine classification association		
• Bureau Veritas (BV)	-	-
• Germanische Lloyd (GL)	-	-
• Lloyds Register of Shipping (LRS)	-	-

PROFIBUS**Optical networks with OLM****Glass fiber-optic cable****Technical specifications (continued)**

Article No.	6XV1820-5AH10	6XV1820-7AH10
Product-type designation	Fiber optic standard cable	INDOOR fiber optic indoor cable
Product description	Flexible glass fiber-optic cable, sold by the meter, unassembled	Glass fiber-optic cable, sold by the meter, unassembled
Acceptability for application	Cable for indoor and outdoor use	Crush-resistant, halogen-free and flame-retardant cable for indoor use
Version of the assembled FO cable	can be fitted with four BFOC connectors	can be fitted with four BFOC connectors
Cable designation	AT-V(ZN)YY 2X1 G 62.5/125	I-V(ZN)HH 2x1 G 62.5/125
Cable length	-	-
Optical data		
Damping ratio per length		
• at 850 nm maximum	3.1 dB/km	3.1 dB/km
• at 1300 nm maximum	0.8 dB/km	0.8 dB/km
• at 1550 nm maximum	-	-
Bandwidth length product		
• at 850 nm	200 GHz·m	200 GHz·m
• at 1300 nm	600 GHz·m	600 GHz·m
Mechanical data		
Number of fibers per FOC core	1	1
Number of FOC cores per FOC cable	2	2
Version of the FO conductor fiber	Multimode graded-index fiber 62.5/125 µm, OM 2	Multimode graded-index fiber 62.5/125 µm, OM 2
Design of the FOC core	Compact core, diameter 900 µm	Solid core, diameter 900 µm
Design of the fiber-optic cable	Segmentable outer conductor	Segmentable inner conductor
Outer diameter		
• of optical fibers	62.5 µm	62.5 µm
• of the optical fiber sheath	125 µm	125 µm
• of the FOC core sheath	3.5 mm	2.9 mm
• of the cable	-	-
Symmetrical deviation		
• of the outer diameter of the FOC core sheath	-	0.1 mm
• of the outer diameter of the line	-	-
Width of the cable sheath	9.8 mm	6.8 mm
Thickness of the cable sheath	6.3 mm	3.9 mm
Material		
• of the fiber-optic cable core	Quartz glass	Quartz glass
• of the optical fiber sheath	Quartz glass	Quartz glass
• of the FOC core sheath	PVC	FRNC
• of the fiber-optic cable sheath	PVC	FRNC
• of the strain relief	Aramide fibers and glass roving	Aramide fibers
Color		
• of the FOC core sheath	Gray	Gray
• of the cable sheath	Black	Orange
Bending radius		
• with single bend minimum permissible	80 mm	30 mm
• with multiple bends minimum permissible	80 mm	50 mm
• with continuous bending	-	-
Number of bending cycles	-	-
Number of torsion cycles in the case of torsion by ± 360° on 1 m cable length	-	-
Traction stress maximum	1 500 N	200 N
Short-term shear force per length	-	300 N/cm
Continuous lateral force per length	200 N/cm	100 N/cm
Weight per length	30 kg/km	30 kg/km

Technical specifications (continued)

Article No.	6XV1820-5AH10	6XV1820-7AH10
Product-type designation	Fiber optic standard cable	INDOOR fiber optic indoor cable
Permitted ambient conditions		
Ambient temperature		
• during operating	-40 ... +85 °C	-20 ... +60 °C
• during storage	-40 ... +85 °C	-25 ... +70 °C
• during transport	-40 ... +85 °C	-25 ... +70 °C
• during installation	-5 ... +50 °C	-5 ... +50 °C
Ambient condition for (standard) operation mode	-	-
Protection class IP	-	-
Burning behaviour	flame resistant according to IEC 60332-1-2 and IEC 60332-3-22 (Cat. A)	flame resistant according to IEC 60332-1-2 and IEC 60332-3-22 (Cat. A)
Chemical resistance		
• to mineral oil	not resistant	not resistant
• to grease	not resistant	not resistant
• to water	Conditional resistance	Conditional resistance
Radiological resistance to UV radiation	resistant	not resistant
Product properties, functions, components general		
Product feature		
• halogen-free	No	Yes
• silicon-free	Yes	Yes
Product component Rodent protection	No	No
Cable length for glass FOC		
• for 100BaseFX for Industrial Ethernet maximum	4 000 m	4 000 m
• for 1000BaseSX for Industrial Ethernet maximum	350 m	350 m
• for 1000BaseLX for Industrial Ethernet maximum	550 m	550 m
• for PROFIBUS maximum	3 000 m	3 000 m
Standards, specifications, approvals		
Verification of suitability	-	-
• RoHS conformity	Yes	Yes
Marine classification association		
• Bureau Veritas (BV)	-	-
• Germanische Lloyd (GL)	-	-
• Lloyds Register of Shipping (LRS)	-	-

PROFIBUS**Optical networks with OLM****Glass fiber-optic cable****Technical specifications (continued)**

Article No.	6XV1820-6AH10	6XV1830-0NH10
Product-type designation	Flexible fiber optic trailing cable	SIENOPYR marine duplex fiber-optic cable
Product description	Flexible glass fiber-optic cable, sold by the meter, unassembled	Glass fiber-optic cable SIENOPYR marine cable, sold by the meter, unassembled
Acceptability for application	Flexible cable for indoor and outdoor use in trailing cables	For fixed installation on ships and offshore units, in all rooms and exposed decks, marine approval assigned
Version of the assembled FO cable	can be fitted with four BFOC connectors	can be fitted with four BFOC connectors
Cable designation	AT-W11Y(ZN)11Y 2 G 62.5/125	MI-VHH 2G 62.5/125 3.1B200 + 0.8F600 + 2x1Cu 300V
Cable length	-	-
Optical data		
Damping ratio per length		
• at 850 nm maximum	3.1 dB/km	3.1 dB/km
• at 1300 nm maximum	0.8 dB/km	0.8 dB/km
• at 1550 nm maximum	-	-
Bandwidth length product		
• at 850 nm	200 GHz·m	200 GHz·m
• at 1300 nm	600 GHz·m	600 GHz·m
Mechanical data		
Number of fibers per FOC core	1	1
Number of FOC cores per FOC cable	2	2
Version of the FO conductor fiber	Multi-mode gradient fiber 62.5/125 µm, OM 2	Multi-mode gradient fiber 62.5/125 µm, OM 2
Design of the FOC core	Hollow core, filled, diameter 1 400 µm	Solid core
Design of the fiber-optic cable	Segmentable outer conductor	Segmentable outer conductor
Outer diameter		
• of optical fibers	62.5 µm	62.5 µm
• of the optical fiber sheath	125 µm	125 µm
• of the FOC core sheath	3.5 mm	2.9 mm
• of the cable	12.9 mm	13.3 mm
Symmetrical deviation		
• of the outer diameter of the FOC core sheath	-	-
• of the outer diameter of the line	-	0.5 mm
Material		
• of the fiber-optic cable core	Quartz glass	Mineral glass
• of the optical fiber sheath	Quartz glass	-
• of the FOC core sheath	PUR	Polyolefine
• of the fiber-optic cable sheath	PUR	SHF1 mixture
• of the strain relief	Aramide fibers, plus central element made of glassreinforced plastic	Aramide fibers
Color		
• of the FOC core sheath	Black	-
• of the cable sheath	Black	Black
Bending radius		
• with single bend minimum permissible	150 mm	133 mm
• with multiple bends minimum permissible	150 mm	266 mm
• with continuous bending	-	-
Number of bending cycles	100 000	-
Number of torsion cycles in the case of torsion by ± 360° on 1 m cable length	-	-
Traction stress maximum	1 000 N	250 N
Short-term shear force per length	-	-
Continuous lateral force per length	-	-
Weight per length	130 kg/km	220 kg/km

Technical specifications (continued)

Article No.	6XV1820-6AH10	6XV1830-0NH10
Product-type designation	Flexible fiber optic trailing cable	SIENOPYR marine duplex fiber-optic cable
Permitted ambient conditions		
Ambient temperature		
• during operating	-30 ... +60 °C	-40 ... +80 °C
• during storage	-30 ... +70 °C	-40 ... +80 °C
• during transport	-30 ... +70 °C	-40 ... +80 °C
• during installation	-30 ... +60 °C	-10 ... +50 °C
Ambient condition for (standard) operation mode	-	At ambient temperatures below -10 degrees Celsius, the cable must not be subjected to any movements other than the normal vibration levels encountered on board ship
Protection class IP	-	-
Burning behaviour	flammable	flame resistant according to IEC 60332-3 (Cat. A)
Chemical resistance		
• to mineral oil	resistant	-
• to grease	resistant	-
• to water	Conditional resistance	Conditional resistance
Radiological resistance to UV radiation	resistant	resistant
Product properties, functions, components general		
Product feature		
• halogen-free	Yes	Yes
• silicon-free	Yes	Yes
Product component Rodent protection	No	No
Cable length for glass FOC		
• for 100BaseFX for Industrial Ethernet maximum	4 000 m	4 000 m
• for 1000BaseSX for Industrial Ethernet maximum	350 m	350 m
• for 1000BaseLX for Industrial Ethernet maximum	550 m	550 m
• for PROFIBUS maximum	3 000 m	3 000 m
Standards, specifications, approvals		
Verification of suitability	-	-
• RoHS conformity	Yes	Yes
Marine classification association		
• Bureau Veritas (BV)	-	Yes
• Germanische Lloyd (GL)	-	Yes
• Lloyds Register of Shipping (LRS)	-	Yes

PROFIBUS**Optical networks with OLM****Glass fiber-optic cable****Technical specifications (continued)**

Article No.	6XV1873-2R	6XV1843-2R
Product-type designation	MM FO Robust Cable GP	SM FO robust cable GP
Product description	Glass fiber-optic cable, sold by the meter, unassembled	Glass fiber-optic cable, sold by the meter, unassembled
Acceptability for application	Cable with longitudinal and lateral water tightness with non-metallic protection against rodents for outdoor and indoor use and for direct laying in soil	Cable with longitudinal and lateral water tightness with non-metallic protection against rodents for outdoor and indoor use and for direct laying in soil
Version of the assembled FO cable	Can be fitted with two BFOC, SC and LC duplex plugs	Can be fitted with two BFOC, SC and LC duplex plugs
Cable designation	AT-V(ZN)H(ZN)BH 2G50/125	AT-V(ZN)H(ZN)BH 4E9/125
Cable length	-	-
Optical data		
Damping ratio per length		
• at 850 nm maximum	2.7 dB/km	-
• at 1300 nm maximum	1 dB/km	0.5 dB/km
• at 1550 nm maximum	-	0.5 dB/km
Bandwidth length product		
• at 850 nm	600 GHz·m	-
• at 1300 nm	1 200 GHz·m	-
Mechanical data		
Number of fibers per FOC core	1	1
Number of FOC cores per FOC cable	2	4
Version of the FO conductor fiber	Multi-mode gradient fiber 50/125/245 µm, OM2	Single mode fiber 4E9/125/900, OS1 and OS2
Design of the FOC core	Solid core, diameter 900 µm	Solid core, diameter 900 µm
Design of the fiber-optic cable	Segmentable	Segmentable
Outer diameter		
• of optical fibers	50 µm	9 µm
• of the optical fiber sheath	125 µm	125 µm
• of the FOC core sheath	2.2 mm	2.2 mm
• of the cable	7.5 mm	9 mm
Symmetrical deviation		
• of the outer diameter of the FOC core sheath	-	-
• of the outer diameter of the line	-	-
Material		
• of the fiber-optic cable core	Quartz glass	Quartz glass
• of the optical fiber sheath	Quartz glass	Quartz glass
• of the FOC core sheath	PE flame retardant	PE flame retardant
• of the fiber-optic cable sheath	PE flame retardant	PE flame retardant
• of the strain relief	Aramide fibers and glass roving	Aramide fibers, plus central support element and glass roving
Color		
• of the FOC core sheath	Orange / black, with directional arrow	Orange / black, with directional arrow (numbering of the core pairs with 1 and 2)
• of the cable sheath	Black	Black
Bending radius		
• with single bend minimum permissible	25 mm	90 mm
• with multiple bends minimum permissible	40 mm	135 mm
• with continuous bending	-	-
Number of bending cycles	-	-
Number of torsion cycles in the case of torsion by ± 360° on 1 m cable length	-	-
Traction stress maximum	1 000 N	1 000 N
Short-term shear force per length	600 N/cm	600 N/cm
Continuous lateral force per length	200 N/cm	200 N/cm
Weight per length	67 kg/km	87 kg/km

Technical specifications (continued)

Article No.	6XV1873-2R	6XV1843-2R
Product-type designation	MM FO Robust Cable GP	SM FO robust cable GP
Permitted ambient conditions		
Ambient temperature		
• during operating	-40 ... +70 °C	-40 ... +70 °C
• during storage	-40 ... +70 °C	-40 ... +70 °C
• during transport	-40 ... +70 °C	-40 ... +70 °C
• during installation	-20 ... +60 °C	-20 ... +60 °C
Ambient condition for (standard) operation mode	-	-
Protection class IP	-	-
Burning behaviour	flame resistant according to IEC 60332-3-24	flame resistant according to IEC 60332-3-24
Chemical resistance		
• to mineral oil	Conditional resistance	Conditional resistance
• to grease	Conditional resistance	Conditional resistance
• to water	resistant	resistant
Radiological resistance to UV radiation	resistant	resistant
Product properties, functions, components general		
Product feature		
• halogen-free	Yes	Yes
• silicon-free	Yes	Yes
Product component Rodent protection	Yes	Yes
Cable length for glass FOC		
• for 100BaseFX for Industrial Ethernet maximum	5 000 m	26 000 m
• for 1000BaseSX for Industrial Ethernet maximum	750 m	-
• for 1000BaseLX for Industrial Ethernet maximum	2 000 m	5 000 m
• for PROFIBUS maximum	3 000 m	15 000 m
Standards, specifications, approvals		
Verification of suitability	-	-
• RoHS conformity	Yes	Yes
Marine classification association		
• Bureau Veritas (BV)	-	-
• Germanische Lloyd (GL)	-	-
• Lloyds Register of Shipping (LRS)	-	-

PROFIBUS

Optical networks with OLM

Glass fiber-optic cable

Technical specifications (continued)

Article No.	6GK1901-0DA20-0AA0
Product-type designation	BFOC Connector Set
Product description	BFOC connector set
Acceptability for application	For connection of fiber-optic cables
Transmission rate	
Transfer rate	
• 1 for Industrial Ethernet	10 Mbit/s
• 2 for Industrial Ethernet	100 Mbit/s
• 3 for Industrial Ethernet	1 000 Mbit/s
• with PROFIBUS	9.6 kbit/s ... 12 Mbit/s
Interfaces	
Number of optical interfaces for optical waveguide	1
Design of optical connections for network components or terminal devices	BFOC connector
Design of the electrical connection FastConnect	No
Mechanical data	
Material of the enclosure	Metal and plastic
Design, dimensions and weight	
Type of cable outlet	180 degree cable outlet
Width	10 mm
Height	10 mm
Depth	10 mm
Net weight	8 g

Article No.	6GK1901-0DA20-0AA0
Product-type designation	BFOC Connector Set
Permitted ambient conditions	
Ambient temperature	
• during operating	-
• during storage	-
• during transport	-
Relative humidity at 25 °C without condensation during operating maximum	-
Protection class IP	IP20
Chemical resistance to water	-
Product properties, functions, components general	
Product feature silicon-free	Yes
Product component strain relief	Yes
Standards, specifications, approvals	
Verification of suitability RoHS conformity	Yes

PROFIBUS

Optical networks with OLM

Glass fiber-optic cable

Ordering data**Article No.****FLEXIBLE FIBER OPTIC CABLE trailing cable**
(62.5/125/1 400), segmentable ²⁾

Multimode cable,
sold by the meter;
max. delivery unit 2 000 m
minimum order 20 m

Preferred lengths;
pre-assembled with
4 BFOC connectors

- 1 m
- 2 m
- 3 m
- 5 m
- 10 m
- 15 m
- 20 m
- 30 m
- 50 m
- 75 m
- 100 m

6XV1820-6AH10

6XV1820-6BH10
6XV1820-6BH20
6XV1820-6BH30
6XV1820-6BH50
6XV1820-6BN10
6XV1820-6BN15
6XV1820-6BN20
6XV1820-6BN30
6XV1820-6BN50
6XV1820-6BN75
6XV1820-6BT10

SIENOPYR marine duplex fiber-optic cable
(62.5/125/900)

Fiber-optic cable for routing on
ships and offshore platforms
Multimode cable,
sold by the meter;
max. delivery unit 1 000 m
minimum order 20 m

6XV1830-0NH10**FO Robust Cable GP**
4E9/125/900 ²⁾

Single-mode cable,
sold by the meter;
max. length 2 000 m;
minimum order 20 m;

6XV1843-2R**Article No.***Accessories***Multimode FO BFOC connector set**

for FO standard cable
(50/125/1 400), FO ground cable
(50/125/1 400), flexible FO trailing
cable, INDOOR FO cable
(62.5/125/900), 20 units

6GK1901-0DA20-0AA0**Multimode FO LC duplex plug**

LC duplex plug (10 units) for
INDOOR FO cable (62.5/125/900),
FO robust cable GP (50/125/900),
FO standard cable (62.5/125/900)

6GK1901-0RB10-2AB0**Singlemode FO LC duplex plug**

LC duplex plug (10 units) for FO
robust cable GP (4E9/125/900)

6GK1901-0SB10-2AB0**PROFIBUS network manual ³⁾**

see
<http://www.siemens.com/automation/csi/net>

SIMATIC NET Manual Collection

Electronic manuals for
communication systems,
communication protocols, and
communication products;
on DVD;
German/English

6GK1975-1AA00-3AA0

- ¹⁾ Special fiber-optic cables, lengths and accessories available on request
- ²⁾ Special tools and specially trained personnel are required for pre-assembling glass fiber-optic cables
- ³⁾ Further manuals can be found for the respective products at <http://www.siemens.com/automation/csi/net>

More information

You can order components and demonstration materials supplementary to the SIMATIC NET cabling range from your local contact.

Technical advice on this subject is available from:

J. Hertlein
I IA SC CI PRM 4
Phone: +49 (911) 750-4465
E-mail: juergen.hertlein@siemens.com

Overview

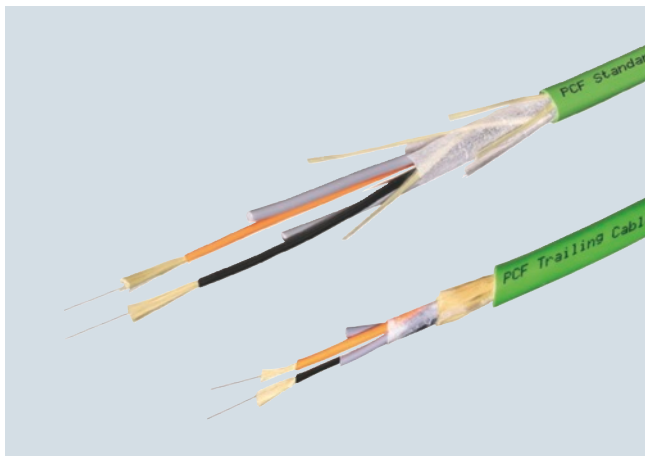

- Electrical isolation of PROFIBUS devices and PROFIBUS segments
- Protection of the transmission path against electromagnetic interference
- Up to 80 m cable length with plastic fiber-optic cables and up to 400 m with PCF fiber-optic cables
- Rugged fiber-optic standard cables, designed for industrial applications
- Extensive approvals (UL)

Benefits



- Plastic and PCF fiber-optic cables can be pre-assembled on site
- Time savings when commissioning thanks to pre-assembled cables
- Protection of the transmission route against electromagnetic interference
- Tap-proof, as the cable does not emit radiation
- Avoidance of overvoltage and equipotential bonding problems

Application

SIMATIC NET plastic and PCF fiber-optic cables are used together with OLM/P for establishing optical PROFIBUS networks or for optical linking of segments using RS 485 technology in indoor and outdoor applications.

Plastic fiber-optic cables and segmented PCF fiber-optic cables can be assembled on-site with 2 x 2 BFOC connectors. The maximum cable length between two OLM/P is 80 m.

Longer cable lengths up to 400 m can be achieved using PCF fiber-optic cables. These cables are also available preassembled with 4 BFOC connectors.

Design

Different types of plastic and PCF fiber-optic cables are offered:

Plastic fiber-optic cables

- **Plastic FOC, standard cable;** rugged round cable with violet PVC outer sheath and Kevlar tension components as well as two plastic fibers with a rugged polyamide inner sheath. For indoor applications; cable lengths up to 80 m.

PCF fiber optic cables

- **PCF fiber-optic cable, standard cables:** Rugged round cables with violet/green PVC outer sheath and Kevlar strain relief elements for applications indoor/outdoors; cable lengths up to 400 m; the following cable versions are available:
 - PCF fiber optic standard cable; with violet PVC outer sheath for indoor applications. The cable is not suitable for assembly in the field; (only available pre-assembled with an insertion tool)
 - PCF Standard Cable GP (general purpose); with green PVC outer sheath for indoor and outdoor applications. The cable is suitable for assembly in the field.
- **PCF fiber optic trailing cable;** rugged round cable with green outer sheath and Kevlar tension elements for trailing cable applications; cable lengths of up to 400 m. The cables are suitable for assembly in the field. The following cable versions are available:
 - PCF Trailing Cable; cable for high mechanical stress, PUR outer sheath, no UL approval
 - PCF Trailing Cable GP (general purpose); cable for low mechanical stress, PVC outer sheath, with UL approval

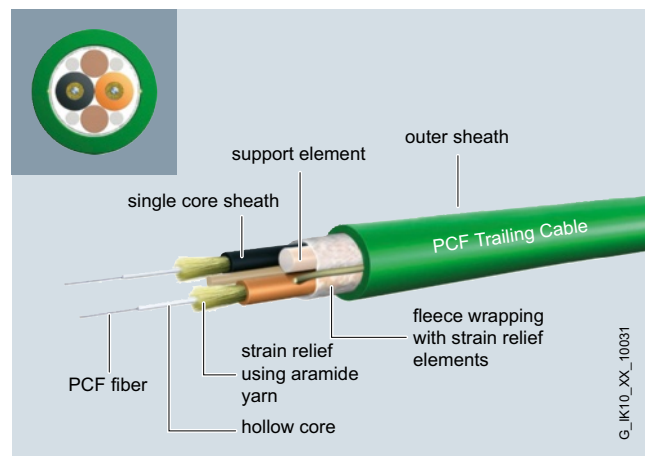

PROFIBUS

Optical networks with OLM

Plastic and PCF fiber-optic cable

Technical specifications

Article No.	6XV1821-0AH10	6XV1821-1BN75
Product-type designation	PROFIBUS Plastic Fiber Optic standard cable	PROFIBUS PCF Fiber Optic standard cable
Product description	Fiber-optic cable with polyoptical fiber, sold by the meter, unassembled	PCF fiber-optic cable with plastic cladding, preferred length, preassembled
Acceptability for application	Cable for indoor applications	Cable for indoor applications
Version of the assembled FO cable	Fitted with four BFOC connectors	Fitted with four BFOC connectors
Cable designation	I-V4Y(ZN)Y 2P 980/1000	I-V(ZN)Y 2K 200/230
Cable length	-	75 m
Optical data		
Damping ratio per length at 650 nm maximum	0.16 dB/m	0.01 dB/m
Bandwidth length product at 650 nm	1 GHz·m	17 GHz·m
Mechanical data		
Number of fibers per FOC core	1	1
Number of FOC cores per FOC cable	2	2
Version of the FO conductor fiber	Step index fiber 980/1 000 µm	Step index fiber 200/230 µm
Design of the FOC core	-	-
Design of the fiber-optic cable	-	-
Outer diameter		
• of optical fibers	980 µm	200 µm
• of the optical fiber sheath	1 000 µm	230 µm
• of the FOC core sheath	2.2 mm	2.2 mm
• of the cable	7.8 mm	4.7 mm
Symmetrical deviation		
• of the outer diameter of the FOC core sheath	0.1 mm	0.1 mm
• of the outer diameter of the line	0.3 mm	-
Material		
• of the fiber-optic cable core	Polymethylmethacrylate (PMMA)	Quartz glass
• of the optical fiber sheath	Fluoridated special polymer	Fluoridated special polymer
• of the FOC core sheath	PA	PVC
• of the fiber-optic cable sheath	PVC	PVC
• of the strain relief	Kevlar fibers	Kevlar fibers
Color		
• of the FOC core sheath	Orange/black	Orange/black
• of the cable sheath	Violet	Violet
Bending radius		
• with single bend minimum permissible	100 mm	47 mm
• with multiple bends minimum permissible	150 mm	70 mm
• with continuous bending	-	-
Number of bending cycles	-	-
Number of torsion cycles in the case of torsion by ± 360° on 1 m cable length	-	-
Traction stress maximum	100 N	200 N
Short-term shear force per length	100 N/cm	100 N/cm
Continuous lateral force per length	-	-
Weight per length	65 kg/km	22 kg/km

Technical specifications (continued)

Article No.	6XV1821-0AH10	6XV1821-1BN75
Product-type designation	PROFIBUS Plastic Fiber Optic standard cable	PROFIBUS PCF Fiber Optic standard cable
Permitted ambient conditions		
Ambient temperature		
• during operating	-30 ... +70 °C	-30 ... +70 °C
• during storage	-30 ... +70 °C	-30 ... +70 °C
• during transport	-30 ... +70 °C	-30 ... +70 °C
• during installation	-5 ... 50 °C	-5 ... +50 °C
Ambient condition for (standard) operation mode	-	-
Protection class IP	-	IP20
Burning behaviour	flame resistant according to IEC 60332-1-2	flame resistant according to IEC 60332-1-2
Chemical resistance		
• to mineral oil	Conditional resistance	Conditional resistance
• to grease	Conditional resistance	Conditional resistance
• to water	-	-
Radiological resistance to UV radiation	Not resistant	Not resistant
Product properties, functions, components general		
Product feature		
• halogen-free	No	No
• silicon-free	Yes	Yes
Product component Rodent protection	No	No
Cable length for POF FOC		
• for Industrial Ethernet maximum	-	-
• for PROFIBUS maximum	80 m	-
Standards, specifications, approvals		
Verification of suitability	UL approval: OFN (NEC Article 770, UL 1651) / CSA approval: OFN (CSA standard C22.2 No232-M1988)	-
• RoHS conformity	Yes	Yes

PROFIBUS**Optical networks with OLM****Plastic and PCF fiber-optic cable****Technical specifications (continued)**

Article No.	6XV1861-2A	6XV1861-2C	6XV1861-2D
Product-type designation	PCF Standard Cable GP	PCF Trailing Cable	PCF Trailing Cable GP
Product description	PCF fiber-optic cable with plastic cladding, sold by the meter, unassembled	PCF fiber-optic cable with plastic cladding, sold by the meter, unassembled	PCF fiber-optic cable with plastic cladding, sold by the meter, unassembled
Acceptability for application	Cable for fixed installation for indoor and outdoor use, UL approval	Cable for use with high mechanical stress and moving applications (e.g. trailing cables), without UL approval	Cable for use with high mechanical stress and moving applications (e.g. trailing cables), UL approval
Version of the assembled FO cable	Can be fitted with SC RJ, SC RJ Plug PRO, BFOC and Simplex connectors	Can be fitted with SC RJ, SC RJ Plug PRO, BFOC and Simplex connectors	Can be fitted with SC RJ, SC RJ Plug PRO, BFOC and Simplex connectors
Cable designation	AT-V(ZN)YY 2K 200/230	AT-V(ZN)Y(ZN)11Y 2K 200/230	AT-V(ZN)Y(ZN)Y 2K 200/230
Cable length	-	-	-
Optical data			
Damping ratio per length at 660 nm maximum	10 dB/km	10 dB/km	10 dB/km
Bandwidth length product at 650 nm	17 GHz·m	17 GHz·m	17 GHz·m
Mechanical data			
Number of fibers per FOC core	1	1	1
Number of FOC cores per FOC cable	2	2	2
Version of the FO conductor fiber	Step index fiber 200/230 µm	Step index fiber 200/230 µm	Step index fiber 200/230 µm
Design of the FOC core	-	-	-
Design of the fiber-optic cable	-	-	-
Outer diameter			
• of optical fibers	200 µm	200 µm	200 µm
• of the optical fiber sheath	230 µm	230 µm	230 µm
• of the FOC core sheath	2.2 mm	2.2 mm	2.2 mm
• of the cable	7.2 mm	8.8 mm	8.8 mm
Symmetrical deviation			
• of the outer diameter of the FOC core sheath	0.1 mm	0.1 mm	0.1 mm
• of the outer diameter of the line	0.5 mm	0.5 mm	0.5 mm
Material			
• of the fiber-optic cable core	Quartz glass	Quartz glass	Quartz glass
• of the optical fiber sheath	Special polymer	Special polymer	Special polymer
• of the FOC core sheath	PVC	PVC	PVC
• of the fiber-optic cable sheath	PVC	PUR	PVC
• of the strain relief	Aramide fibers	Aramide fibers	Aramide fibers
Color			
• of the FOC core sheath	Orange/black	Orange/black	Orange/black
• of the cable sheath	green	green	green
Bending radius			
• with single bend minimum permissible	70 mm	130 mm	130 mm
• with multiple bends minimum permissible	105 mm	175 mm	175 mm
• with continuous bending	-	-	-
Number of bending cycles	-	5 000 000	5 000 000
Number of torsion cycles in the case of torsion by ± 360° on 1 m cable length	-	-	-
Traction stress maximum	100 N	800 N	800 N
Short-term shear force per length	500 N/cm	500 N/cm	500 N/cm
Continuous lateral force per length	300 N/cm	300 N/cm	300 N/cm
Weight per length	45 kg/km	85 kg/km	85 kg/km

Technical specifications (continued)

Article No.	6XV1861-2A	6XV1861-2C	6XV1861-2D
Product-type designation	PCF Standard Cable GP	PCF Trailing Cable	PCF Trailing Cable GP
Permitted ambient conditions			
Ambient temperature			
• during operating	-40 ... +90 °C	-25 ... +75 °C	-25 ... +75 °C
• during storage	-40 ... +90 °C	-30 ... +75 °C	-30 ... +75 °C
• during transport	-40 ... +90 °C	-30 ... +75 °C	-30 ... +75 °C
• during installation	-5 ... +50 °C	-5 ... +50 °C	-5 ... +50 °C
Ambient condition for (standard) operation mode	-	-	-
Protection class IP	-	-	-
Burning behaviour	flame resistant according to IEC 60332-1-2 and IEC 60332-3-22 (Cat. A)	flame-retardant	flame resistant according to IEC 60332-1-2 and IEC 60332-3-22 (Cat. A)
Chemical resistance			
• to mineral oil	Conditional resistance	resistant	Conditional resistance
• to grease	Conditional resistance	resistant	Conditional resistance
• to water	Conditional resistance	Conditional resistance	Conditional resistance
Radiological resistance to UV radiation	resistant	resistant	resistant
Product properties, functions, components general			
Product feature			
• halogen-free	No	No	No
• silicon-free	Yes	Yes	Yes
Product component Rodent protection	No	No	No
Cable length for PCF FOC			
• for Industrial Ethernet maximum	100 m	100 m	100 m
• for PROFIBUS maximum	400 m	400 m	400 m
Standards, specifications, approvals			
Verification of suitability	UL approval: OFN (NEC Article 770, UL 1651) / CSA approval: OFN 90 Cel, FT1, FT4 (CSA standard C22.2 No232-M1988)	-	UL approval: OFN (NEC Article 770, UL 1651) / CSA approval: OFN 90 Cel, FT1, FT4 (CSA standard C22.2 No232-M1988)
• RoHS conformity	Yes	Yes	Yes

PROFIBUS

Optical networks with OLM

Plastic and PCF fiber-optic cable

Technical specifications (continued)

Article No.	6GK 905-1PA00
Product-type designation	PB BFOC Plug POF
Product description	BFOC connector
Acceptability for application	For assembling PB plastic fiber-optic cables for OLM/P..
Transmission rate	
Transfer rate	
• 1 for Industrial Ethernet	-
• 2 for Industrial Ethernet	-
• 3 for Industrial Ethernet	-
• with PROFIBUS	9.6 kbit/s ... 12 Mbit/s
Interfaces	
Number of optical interfaces for optical waveguide	1
Design of optical connections for network components or terminal devices	BFOC connector
Design of the electrical connection FastConnect	No
Mechanical data	
Material of the enclosure	metal
Design, dimensions and weight	
Type of cable outlet	180 degree cable outlet
Width	10 mm
Height	10 mm
Depth	10 mm
Net weight	10 g
Permitted ambient conditions	
Protection class IP	IP20
Chemical resistance to water	-
Product properties, functions, components general	
Product feature silicon-free	Yes
Product component strain relief	Yes
Standards, specifications, approvals	
Verification of suitability RoHS conformity	Yes

Ordering data**Article No.****PROFIBUS Plastic Fiber Optic, standard cable**

Rugged round cable with 2 plastic fiber-optic cores, PVC outer sheath and PA inner sheath, for indoor use

- Without connector
- Sold by the meter
 - 50 m ring
 - 100 m ring

Preferred lengths pre-assembled with 2 x 2 BFOC plugs, lash length 20 cm each, for connecting OLM/P..

- 1 m
- 2 m
- 5 m
- 10 m
- 15 m
- 20 m
- 25 m
- 30 m
- 50 m
- 65 m
- 80 m

6XV1821-0AH10
6XV1821-0AN50
6XV1821-0AT10

6XV1821-0BH10
6XV1821-0BH20
6XV1821-0BH50
6XV1821-0BN10
6XV1821-0BN15
6XV1821-0BN20
6XV1821-0BN25
6XV1821-0BN30
6XV1821-0BN50
6XV1821-0BN65
6XV1821-0BN80

PROFIBUS Plastic Fiber Optic, stripping tool set

Tools for removing the outer sheath or core sheath of PROFIBUS Plastic Fiber Optic cables

6GK1905-6PA10

PROFIBUS Plastic Fiber Optic, BFOC connector set

20 BFOC plugs for assembly of PROFIBUS Plastic Fiber Optic cables for OLM/P..

6GK1905-1PA00

PROFIBUS Plastic Fiber Optic, BFOC crimping tool

For assembly of BFOC plug on PROFIBUS Plastic Fiber Optic cables

6GK1905-6PB00

PROFIBUS Plastic Fiber Optic, BFOC polishing set

Polishing set for grinding and polishing the BFOC plug face for PROFIBUS Plastic Fiber Optic cables with OLM/P..

6GK1905-6PS00

Ordering data	Article No.	Article No.	
PROFIBUS PCF Fiber Optic standard cable PCF fiber-optic cable with 2 cores, PVC outer sheath, for bridging large distances up to 400 m, Preferred lengths pre-assembled with 2 x 2 BFOC plugs, lash length 20 cm each, with insertion tool mounted on one end for connecting OLM/P.. <ul style="list-style-type: none"> • 75 m • 100 m • 150 m • 200 m • 250 m • 300 m • 400 m 	6XV1821-1BN75 6XV1821-1BT10 6XV1821-1BT15 6XV1821-1BT20 6XV1821-1BT25 6XV1821-1BT30 6XV1821-1BT40	PROFIBUS PCF Trailing Cable 200/230 Trailing cable, segmentable, <u>sold by the meter</u> ; max. length 2 000 m; minimum order 20 m; Preferred lengths pre-assembled with 4 BFOC connectors <ul style="list-style-type: none"> • 75 m • 100 m • 150 m • 200 m • 250 m • 300 m • 400 m 	6XV1861-2C 6XV1861-3CN75 6XV1861-3CT10 6XV1861-3CT15 6XV1861-3CT20 6XV1861-3CT25 6XV1861-3CT30 6XV1861-3CT40
PROFIBUS PCF Standard Cable GP 200/230 Standard cable, segmentable, <u>sold by the meter</u> ; max. length 2 000 m; minimum order 20 m; Preferred lengths pre-assembled with 4 BFOC connectors <ul style="list-style-type: none"> • 75 m • 100 m • 150 m • 200 m • 250 m • 300 m • 400 m 	6XV1861-2A 6XV1861-3AN75 6XV1861-3AT10 6XV1861-3AT15 6XV1861-3AT20 6XV1861-3AT25 6XV1861-3AT30 6XV1861-3AT40	PROFIBUS PCF Trailing Cable GP 200/230 Trailing cable, segmentable, <u>sold by the meter</u> ; max. length 2 000 m; minimum order 20 m; Preferred lengths pre-assembled with 4 BFOC connectors <ul style="list-style-type: none"> • 75 m • 100 m • 150 m • 200 m • 250 m • 300 m • 400 m 	6XV1861-2D 6XV1861-3DN75 6XV1861-3DT10 6XV1861-3DT15 6XV1861-3DT20 6XV1861-3DT25 6XV1861-3DT30 6XV1861-3DT40
		SIMATIC NET Manual Collection Electronic manuals for communication systems, communication protocols, and communication products; on DVD; German/English	6GK1975-1AA00-3AA0

More information

You can order components and demonstration materials supplementary to the SIMATIC NET cabling range from your local contact.

Technical advice on this subject is available from:

J. Hertlein
 I IA SC CI PRM 4
 Phone: +49 (911) 750-4465
 E-mail: juergen.hertlein@siemens.com

PROFIBUS

Optical networks with OLM

PCF-FOC termination kit

Overview



- Compact, rugged assembly case for PCF fiber-optic cables
- Special versions for easy assembly of HP Simplex and BFOC plugs on PCF fiber-optic cables
- The quality of the assembly can be checked using the enclosed microscope

Benefits



- Easy installation of the unassembled cables in industrial plants
- Flexible assembly of connectors on PCF fiber-optic cables on site (HP Simplex, BFOC connectors)
- Mistakes are avoided with easy visual inspection of the assembled connector on site using a microscope
- PCF fiber-optic cables are easily repaired on site by installing a new PCF cable

Application

SIMATIC NET PCF fiber-optic conductors are used to construct optical indoor and outdoor PROFIBUS DP networks. They are easy to assemble on site with 2 x 2 Simplex connectors or 2 x 2 BFOC connectors. The maximum cable length between two DP devices is 300 m and between two OLMs 400 m.

PROFIBUS DP devices with integrated optical interface (Simplex connection technology) include, for example, OBT, CP 342-5 FO, CP 5613 FO, IM 153-2 FO, IM 467 FO.

Design

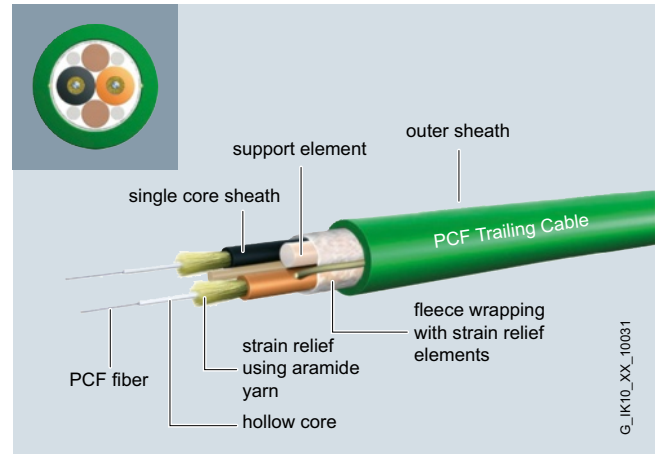

Two versions of the assembly case are available for PCF fiber-optic cables:

- Assembly case for HP Simplex connectors; for on-site pre-assembly of HP Simplex connectors; comprising a stripping tool, buffer stripping tool, Kevlar cutters, fiber breaking tool, crimping tool and microscope
- Assembly case for BFOC connectors; for on-site pre-assembly of BFOC connectors; comprising a stripping tool, buffer stripping tool, Kevlar cutters, fiber breaking tool and microscope

G_IK10_XX_10031

Technical specifications

Article No.	6GK1900-0KB00-0AC0	6GK1900-0HB00-0AC0
Product-type designation	PB Simplex Plug PCF	PB BFOC Plug PCF
Product description	Simplex crimp connector for PCF fiber-optic cables with plastic cladding	BFOC screw connector for PCF fiber-optic cables with plastic cladding
Acceptability for application	For connection of PCF fiber-optic cables	For connection of PCF fiber-optic cables
Transmission rate		
Transfer rate		
• 1 for Industrial Ethernet	-	-
• 2 for Industrial Ethernet	-	-
• 3 for Industrial Ethernet	-	-
• with PROFIBUS	9.6 kbit/s ... 12 Mbit/s	9.6 kbit/s ... 12 Mbit/s
Interfaces		
Number of optical interfaces for optical waveguide	1	1
Design of optical connections for network components or terminal devices	Simplex connector	BFOC connector
Design of the electrical connection FastConnect	No	No
Mechanical data		
Material of the enclosure	plastic	Metal and plastic
Design, dimensions and weight		
Type of cable outlet	180 degree cable outlet	180 degree cable outlet
Width	9.4 mm	10 mm
Height	6.1 mm	10 mm
Depth	29.9 mm	10 mm
Net weight	20 g	8 g
Permitted ambient conditions		
Protection class IP	IP20	IP20
Chemical resistance to water	-	-
Product properties, functions, components general		
Product feature silicon-free	Yes	Yes
Product component strain relief	Yes	Yes
Standards, specifications, approvals		
Verification of suitability RoHS conformity	Yes	Yes

PROFIBUS

Optical networks with OLM

PCF-FOC termination kit

Ordering data**Article No.****Termination Kit****for Simplex connectors**

Assembly case for local assembly of PCF Simplex connectors; comprising a stripping tool, buffer stripping tool, Kevlar cutters, fiber breaking tool, crimping tool and microscope

6GK1900-0KL00-0AA0**Termination Kit****for BFOC connectors**

Assembly case for local assembly of BFOC connectors; comprising a stripping tool, buffer stripping tool, Kevlar cutters, fiber breaking tool, and microscope

6GK1900-0HL00-0AA0**Connector****Simplex connector**

with cleaning materials; 50 crimp connectors for assembly on PCF fiber-optic cables on site

6GK1900-0KB00-0AC0**BFOC connector**

with cleaning materials; 20 screw connectors for assembly on PCF fiber-optic cables on site

6GK1900-0HB00-0AC0**More information**

You can order components supplementary to the SIMATIC NET cabling range from your local contact.

Technical advice on this subject is available from:

J. Hertlein

I IA SC CI PRM 4

Phone: +49 (911) 750-4465

E-mail: juergen.hertlein@siemens.com

Overview



- Construction of optical PROFIBUS networks (line, star, ring) with glass, PCF and plastic fiber optic cables
- High availability can be achieved using a redundant power supply and redundant cable routing
- Function monitoring by means of signaling contact
- All PROFIBUS data transmission rates from 9.6 Kbit/s to 12 Mbit/s inclusive 45.45 Kbit/s for PROFIBUS PA
- Monitoring of the fiber optic cable routes on LEDs for channel monitoring or using a voltmeter across measurement terminals

Benefits

get **Designed for Industry**

- High availability of the network thanks to redundant optical ring
- Fast fault localization due to signaling of the fiber-optic line quality to LEDs and signaling contact (e.g. import of the level value of the fiber-optic line quality via an analog module into a programmable logic controller)
- Large range due to use of glass fiber optic cables in lengths of up to 15 km
- OLM/G12-EEC for outdoor use down to -25 °C

Application

With the PROFIBUS OLM (Optical Link Modules), optical PROFIBUS networks can be established in linear, star and redundant ring topologies.

The data transfer rate of a fiber optic line is independent of the distance and can be up to 12 Mbit/s.

Possible applications for OLMs include:

- System buses based on PROFIBUS
- Networking between buildings using glass fiber optic cable
- Mixed networks with electrical and optical segments
- Networks covering a wide area (road tunnels, traffic control systems)
- Networks with high availability requirements (redundant ring networks)

Design

The OLMs have a compact metal housing. It is suitable for mounting on a standard rail or for wall mounting with a mounting plate.

The 24 V power supply is fed in through a terminal block and can be redundantly connected.

The signaling contact allows a digital signal to be transferred to PLCs or HMI systems for evaluation.

OLMs can be combined with each other and individual stations or complete electrical segments can be integrated into the optical PROFIBUS network through an electrical interface. With the PROFIBUS OLM P22 and OLM G22, two electric PROFIBUS segments can be connected separated from each other.

OLMs are available with one or two fiber optic interfaces with BFOC connectors for different types of fiber optic cables:

- Plastic fiber-optic cables (980/1 000 μm) can be used for single lengths of up to 80 m. They can also be assembled with BFOC cable connectors on site.
- PCF fiber-optic cables (200/230 μm) can be used for single lengths of up to 400 m. They are offered preassembled with four BFOC plugs and an insertion tool.
- Glass fiber multimode fiber-optic cables (62.5/125 μm) such as the SIMATIC NET Fiber Optic cables can be used for long distances of up to 3000 m. They must be ordered preassembled with 4 BFOC plugs or as a FastConnect FO system for assembly on site.
- Singlemode fiber-optic cables (10/125 μm or 9/125 μm fibers) can be used for extremely long distances up to 15 km.

Function

- Automatic detection of all PROFIBUS data transmission rates 9.6 Kbit/s to 12 Mbit/s inclusive 45.45 Kbit/s (PROFIBUS PA)
- Construction of the following network topologies: Line, star, redundant ring
- High availability due to media redundancy. The distance between two OLMs in the redundant ring is only limited by the optical range of the modules
- RS485 interface with segment capability (Sub-D female connector)
- Unrestricted multimaster operation: Expanded segmentation functions for localization of faults to fiber optic and RS485 segments
- Fast localization of faults:
 - Indication of module status through floating signaling contact
 - Checking the fiber optic cable route quality on LEDs
 - Checking the fiber optic cable route quality Measurement output for optical receiver for logging and plausibility checking of the fiber optic path attenuation with a voltmeter
- High cascading depth: Line and redundant ring up to 124 OLM (only limited by monitoring times)

PROFIBUS

Optical networks with OLM

OLM Optical Link Module

Integration

3

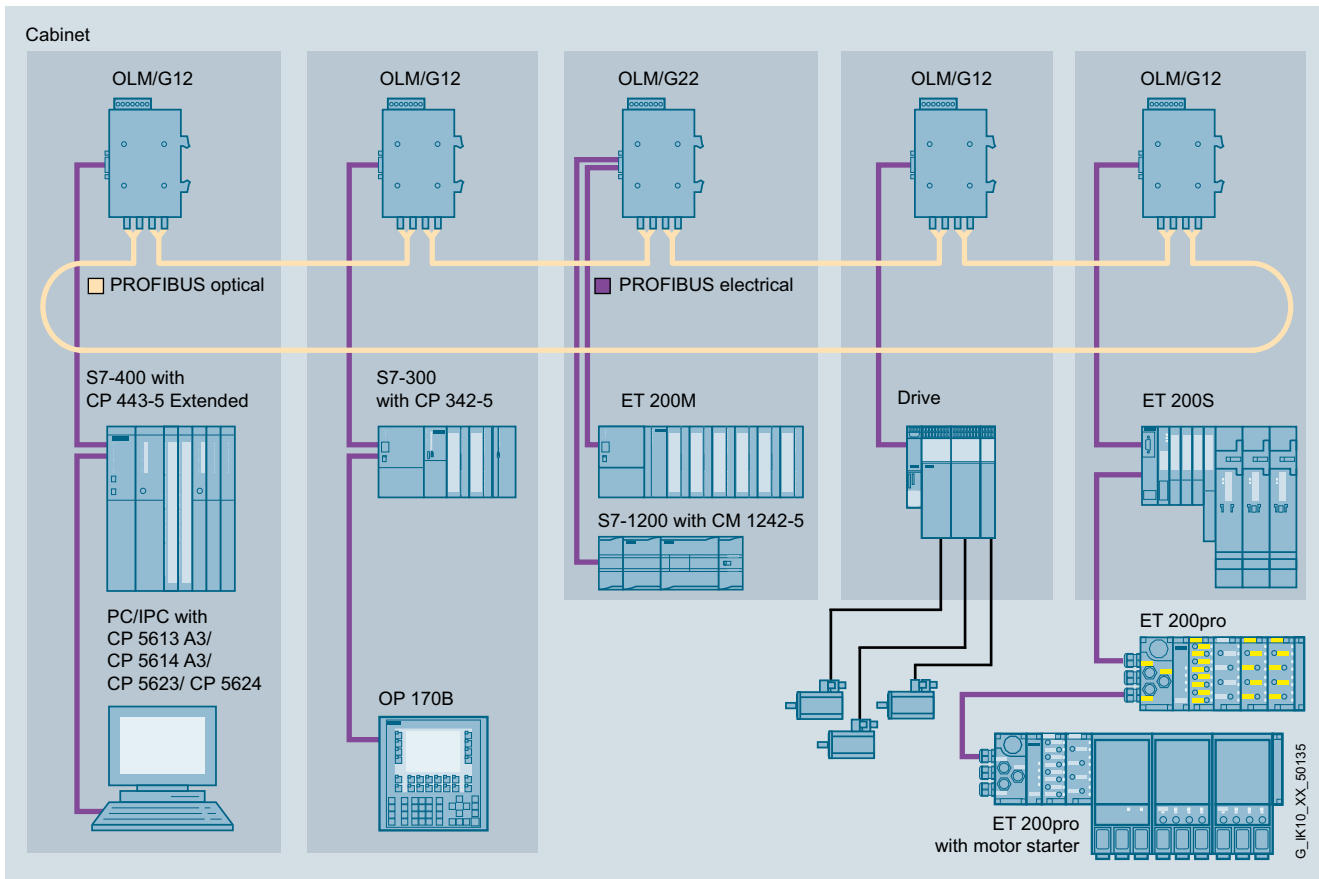

Example of a system configuration with OLM for PROFIBUS in a ring structure

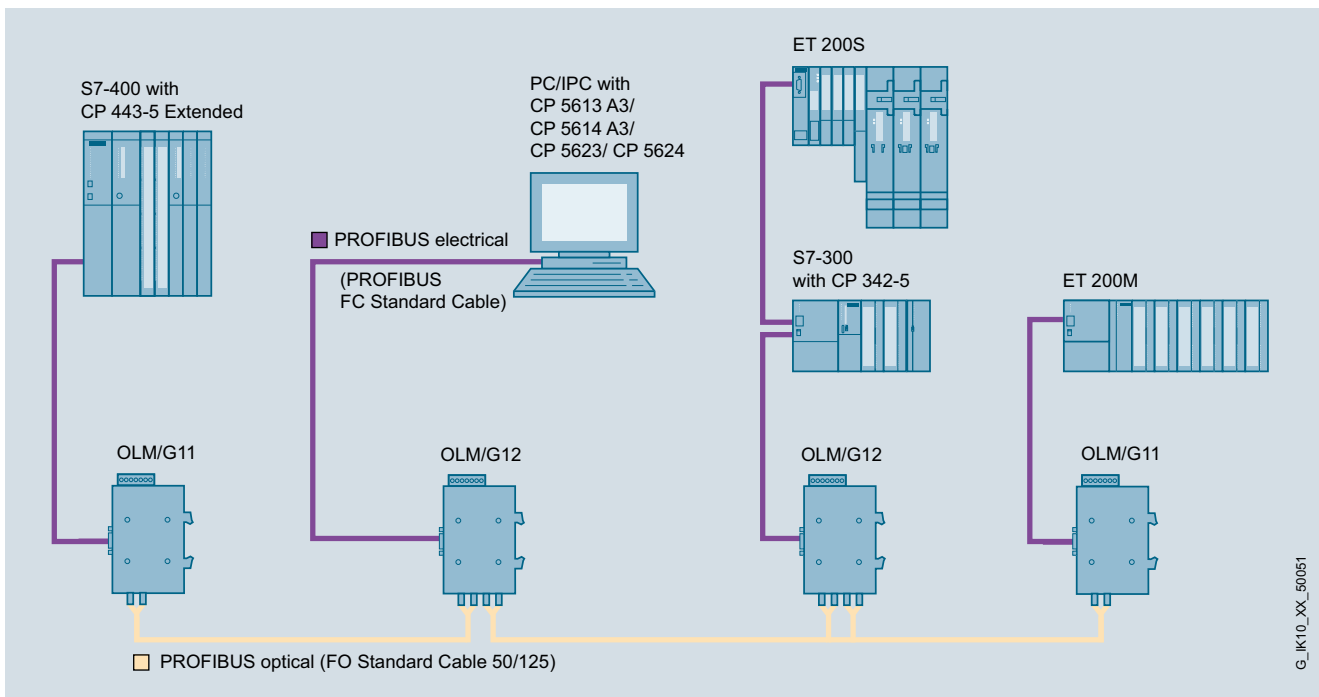

Optical line topology with PROFIBUS OLM G11/G12

Integration (continued)

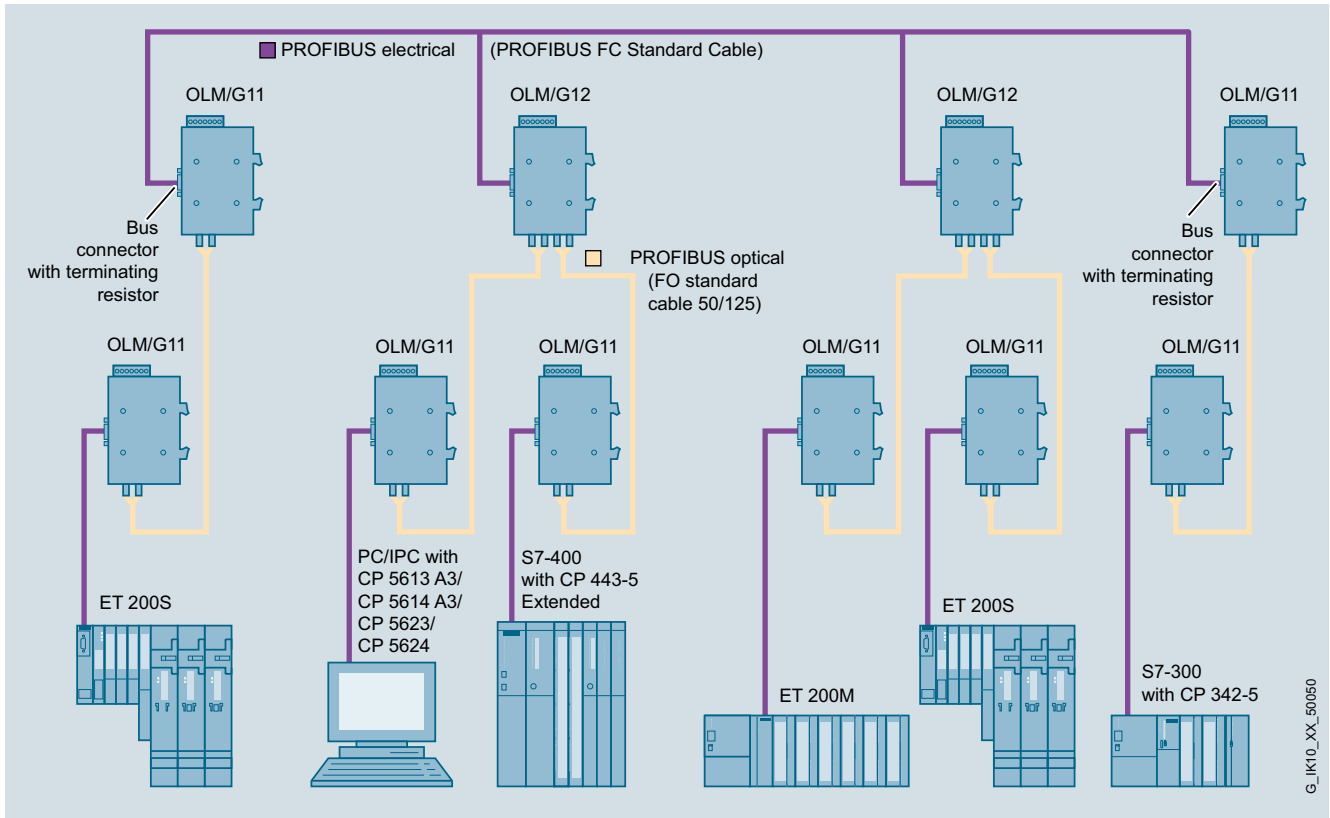

Optical star topology with PROFIBUS OLM G11/G12

PROFIBUS

Optical networks with OLM

OLM Optical Link Module

Technical specifications

Article No.	6GK1503-2CA00	6GK1503-3CA00	6GK1503-4CA00
Product-type designation	PROFIBUS OLM P11	PROFIBUS OLM P12	PROFIBUS OLM P22
Transmission rate			
Transfer rate			
• with PROFIBUS	9.6 kbit/s ... 12 Mbit/s	9.6 kbit/s ... 12 Mbit/s	9.6 kbit/s ... 12 Mbit/s
• With PROFIBUS PA	45.45 kbit/s	45.45 kbit/s	45.45 kbit/s
Interfaces			
Number of electrical/optical connections for network components or terminal equipment maximum	2	3	4
Number of electrical connections			
• for network components and terminal equipment	1	1	2
• for measuring instrument	1	1	1
• for signaling contact	1	1	1
• for power supply	1	1	1
• for redundant power supply	1	1	1
Design of electrical connection			
• for network components and terminal equipment	9-pin Sub-D socket	9-pin Sub-D socket	9-pin Sub-D socket
• for measuring device	2-pole terminal block	2-pole terminal block	2-pole terminal block
• for power supply and signaling contact	5-pole terminal block	5-pole terminal block	5-pole terminal block
Number of optical interfaces for optical waveguide	1	2	2
Design of the optical interface for optical waveguide	BFOC port	BFOC port	BFOC port
Optical data			
Damping ratio of FOC transmission link			
• for glass FOC with 10/125 µm or 9/125 µm at 0.5 dB/km maximum	-	-	-
• for glass FOC with 50/125 µm at 3 dB/km maximum	-	-	-
• for glass FOC with 62.5/125 µm			
- at 1 dB/km maximum	-	-	-
- at 3.5 dB/km maximum	-	-	-
• for PCF FOC with 200/230 µm at 10 dB/km	-	-	-
• for POF FOC with 980/1 000 µm at 230 dB/km	13 dB	13 dB	13 dB
Signal delay time in bit time	6.5 bit	6.5 bit	6.5 bit
Injectable optical power relating to 1 mW			
• for glass FOC with 10/125 µm or 9/125 µm at 0.5 dB/km	-	-	-
• for glass FOC with 50/125 µm at 3 dB/km	-	-	-
• for glass FOC with 62.5/125 µm			
- at 1 dB/km	-	-	-
- at 3.5 dB/km	-	-	-
• of FOC transmission link			
- for PCF FOC with 200/230 µm at 10 dB/km	-17 dB	-17 dB	-17 dB
- for POF FOC with 980/1 000 µm at 230 dB/km	-5 dB	-5 dB	-5 dB

Technical specifications (continued)

Article No.	6GK1503-2CA00	6GK1503-3CA00	6GK1503-4CA00
Product-type designation	PROFIBUS OLM P11	PROFIBUS OLM P12	PROFIBUS OLM P22
Optical sensitivity relating to 1 mW			
• for glass FOC with 10/125 µm or 9/125 µm at 0.5 dB/km	-	-	-
• for glass FOC with 50/125 µm at 3 dB/km	-	-	-
• for glass FOC with 62.5/125 µm			
- at 1 dB/km	-	-	-
- at 3.5 dB/km	-	-	-
• of FOC transmission link			
- for PCF FOC with 200/230 µm at 10 dB/km	-25 dB	-	-
- for POF FOC with 980/1 000 µm at 230 dB/km	-25 dB	-	-
Wavelength			
• for glass FOC with 10/125 µm or 9/125 µm compatible with interface at 0.5 dB/km	-	-	-
• for glass FOC with 50/125 µm compatible with interface at 3 dB/km	-	-	-
• for glass FOC with 62.5/125 µm compatible with interface			
- at 1 dB/km	-	-	-
- at 3.5 dB/km	-	-	-
• of FOC transmission link			
- for PCF FOC with 200/230 µm at 10 dB/km	660 nm	660 nm	660 nm
- for POF FOC with 980/1 000 µm at 230 dB/km	660 nm	660 nm	660 nm
Cable length			
• for glass FOC with 10/125 µm or 9/125 µm at 0.5 dB/km maximum	-	-	-
• for glass FOC with 50/125 µm at 3 dB/km maximum	-	-	-
• for glass FOC with 62.5/125 µm at 1 dB/km maximum	-	-	-
• for glass FOC with 62.5/125 µm at 3.5 dB/km maximum	-	-	-
• for PCF FOC with 200/230 µm at 10 dB/km maximum	400 m	400 m	400 m
• for POF FOC with 980/1 000 µm at 230 dB/km maximum	80 m	80 m	80 m
Signal-Inputs/outputs			
Operating voltage of signaling contacts at DC rated value	24 V	24 V	24 V
Operating current of signaling contacts at DC maximum	0.1 A	0.1 A	0.1 A
Supply voltage, current consumption, power loss			
Type of supply voltage	DC	DC	DC
Supply voltage for DC			
• rated value	24 V	24 V	24 V
• minimum	18.8 V	18.8 V	18.8 V
• maximum	28.8 V	28.8 V	28.8 V
Product component fusing at power supply input	Yes	Yes	Yes
Type of fusing at input for supply voltage	-	-	-
Consumed current At 24 V with DC maximum	0.2 A	0.2 A	0.2 A
Active power loss at 24 V for DC	-	-	-

PROFIBUS

Optical networks with OLM

OLM Optical Link Module

Technical specifications (continued)

Article No.	6GK1503-2CA00	6GK1503-3CA00	6GK1503-4CA00
Product-type designation	PROFIBUS OLM P11	PROFIBUS OLM P12	PROFIBUS OLM P22
Permitted ambient conditions			
Ambient temperature			
• during operating	0 ... 60 °C	0 ... 60 °C	0 ... 60 °C
• during storage	-40 ... +70 °C	-40 ... +70 °C	-40 ... +70 °C
• during transport	-40 ... +70 °C	-40 ... +70 °C	-40 ... +70 °C
Relative humidity at 25 °C without condensation during operating maximum	95 %	95 %	95 %
Protection class IP	IP40	IP40	IP40
Design, dimensions and weight			
Design	compact	compact	compact
Width	39.5 mm	39.5 mm	39.5 mm
Height	112 mm	112 mm	112 mm
Depth	74.5 mm	74.5 mm	74.5 mm
Net weight	340 g	340 g	340 g
Mounting type			
• 35 mm DIN rail mounting	Yes	Yes	Yes
• wall mounting	Yes	Yes	Yes
Product properties, functions, components general			
Product function Ring redundancy	Yes	Yes	Yes
Standards, specifications, approvals			
Standard			
• for EMC from FM	FM3611: Class 1, Divison 2, Group A, B, C, D / T4, Class 1, Zone 2, Group IIC, T4	FM3611: Class 1, Divison 2, Group A, B, C, D / T4, Class 1, Zone 2, Group IIC, T4	FM3611: Class 1, Divison 2, Group A, B, C, D / T4, Class 1, Zone 2, Group IIC, T4
• for hazardous zone	EN 60079-0: 2006, EN60079-15: 2005, EN60079-28: 2007, II 3 (2) G Ex nA [opis] IIC T4 KEMA 09 ATEX 0173X	EN 60079-0: 2006, EN60079-15: 2005, EN60079-28: 2007, II 3 (2) G Ex nA [opis] IIC T4 KEMA 09 ATEX 0173X	EN 60079-0: 2006, EN60079-15: 2005, EN60079-28: 2007, II 3 (2) G Ex nA [opis] IIC T4 KEMA 09 ATEX 0173X
• for safety of CSA and UL	UL 60950-1, CSA C22.2 Nr. 60950-1	UL 60950-1, CSA C22.2 Nr. 60950-1	UL 60950-1, CSA C22.2 Nr. 60950-1
• for hazardous area of CSA and UL	UL 1604 and UL 2279-15 (Hazardous Location), CSA C22.2 No. 213-M1987, Class 1 / Division 2 / Group A, B, C, D / T4, Class 1 / Zone 2 / Group IIC / T4	UL 1604 and UL 2279-15 (Hazardous Location), CSA C22.2 No. 213-M1987, Class 1 / Division 2 / Group A, B, C, D / T4, Class 1 / Zone 2 / Group IIC / T4	UL 1604 and UL 2279-15 (Hazardous Location), CSA C22.2 No. 213-M1987, Class 1 / Division 2 / Group A, B, C, D / T4, Class 1 / Zone 2 / Group IIC / T4
• for emitted interference	EN 61000-6-4 (Class A)	EN 61000-6-4 (Class A)	EN 61000-6-4 (Class A)
• for interference immunity	EN 61000-6-2	EN 61000-6-2	EN 61000-6-2
Verification of suitability	EN 61000-6-2, EN 61000-6-4	EN 61000-6-2, EN 61000-6-4	EN 61000-6-2, EN 61000-6-4
• CE mark	Yes	Yes	Yes
• C-Tick	Yes	Yes	Yes
Marine classification association			
• American Bureau of Shipping Europe Ltd. (ABS)	Yes	Yes	Yes
• Bureau Veritas (BV)	Yes	Yes	Yes
• Det Norske Veritas (DNV)	Yes	Yes	Yes
• Germanische Lloyd (GL)	Yes	Yes	Yes
• Lloyds Register of Shipping (LRS)	Yes	Yes	Yes
• Nippon Kaiji Kyokai (NK)	Yes	Yes	Yes

Technical specifications (continued)

Article No.	6GK1503-2CB00	6GK1503-3CB00	6GK1503-4CB00
Product-type designation	PROFIBUS OLM G11	PROFIBUS OLM G12	PROFIBUS OLM G22
Transmission rate			
Transfer rate			
• with PROFIBUS	9.6 kbit/s ... 12 Mbit/s	9.6 kbit/s ... 12 Mbit/s	9.6 kbit/s ... 12 Mbit/s
• With PROFIBUS PA	45.45 kbit/s	45.45 kbit/s	45.45 kbit/s
Interfaces			
Number of electrical/optical connections for network components or terminal equipment maximum	2	3	4
Number of electrical connections			
• for network components and terminal equipment	1	1	2
• for measuring instrument	1	1	1
• for signaling contact	1	1	1
• for power supply	1	1	1
• for redundant power supply	1	1	1
Design of electrical connection			
• for network components and terminal equipment	9-pin Sub-D socket	9-pin Sub-D socket	9-pin Sub-D socket
• for measuring device	2-pole terminal block	2-pole terminal block	2-pole terminal block
• for power supply and signaling contact	5-pole terminal block	5-pole terminal block	5-pole terminal block
Number of optical interfaces for optical waveguide	1	2	2
Design of the optical interface for optical waveguide	BFOC port	BFOC port	BFOC port
Optical data			
Damping ratio of FOC transmission link			
• for glass FOC with 10/125 µm or 9/125 µm at 0.5 dB/km maximum	-	-	-
• for glass FOC with 50/125 µm at 3 dB/km maximum	10 dB	10 dB	10 dB
• for glass FOC with 62.5/125 µm			
- at 1 dB/km maximum	-	-	-
- at 3.5 dB/km maximum	12 dB	12 dB	12 dB
• for PCF FOC with 200/230 µm at 10 dB/km	-	-	-
• for POF FOC with 980/1 000 µm at 230 dB/km	-	-	-
Signal delay time in bit time	6.5 bit	6.5 bit	6.5 bit
Injectable optical power relating to 1 mW			
• for glass FOC with 10/125 µm or 9/125 µm at 0.5 dB/km	-	-	-
• for glass FOC with 50/125 µm at 3 dB/km	-16 dB	-16 dB	-16 dB
• for glass FOC with 62.5/125 µm			
- at 1 dB/km	-	-	-
- at 3.5 dB/km	-13 dB	-13 dB	-13 dB
• of FOC transmission link			
- for PCF FOC with 200/230 µm at 10 dB/km	-	-	-
- for POF FOC with 980/1 000 µm at 230 dB/km	-	-	-

PROFIBUS

Optical networks with OLM

OLM Optical Link Module

Technical specifications (continued)

Article No.	6GK1503-2CB00	6GK1503-3CB00	6GK1503-4CB00
Product-type designation	PROFIBUS OLM G11	PROFIBUS OLM G12	PROFIBUS OLM G22
Optical sensitivity relating to 1 mW			
• for glass FOC with 10/125 µm or 9/125 µm at 0.5 dB/km	-	-	-
• for glass FOC with 50/125 µm at 3 dB/km	-28 dB	-28 dB	-28 dB
• for glass FOC with 62.5/125 µm			
- at 1 dB/km	-	-	-
- at 3.5 dB/km	-28 dB	-28 dB	-28 dB
• of FOC transmission link			
- for PCF FOC with 200/230 µm at 10 dB/km	-	-	-
- for POF FOC with 980/1 000 µm at 230 dB/km	-	-	-
Wavelength			
• for glass FOC with 10/125 µm or 9/125 µm compatible with interface at 0.5 dB/km	-	-	-
• for glass FOC with 50/125 µm compatible with interface at 3 dB/km	860 nm	860 nm	860 nm
• for glass FOC with 62.5/125 µm compatible with interface			
- at 1 dB/km	-	-	-
- at 3.5 dB/km	860 nm	860 nm	860 nm
• of FOC transmission link			
- for PCF FOC with 200/230 µm at 10 dB/km	-	-	-
- for POF FOC with 980/1 000 µm at 230 dB/km	-	-	-
Cable length			
• for glass FOC with 10/125 µm or 9/125 µm at 0.5 dB/km maximum	-	-	-
• for glass FOC with 50/125 µm at 3 dB/km maximum	3 km	3 km	3 km
• for glass FOC with 62.5/125 µm at 1 dB/km maximum	-	-	-
• for glass FOC with 62.5/125 µm at 3.5 dB/km maximum	3 km	3 km	3 km
• for PCF FOC with 200/230 µm at 10 dB/km maximum	-	-	-
• for POF FOC with 980/1 000 µm at 230 dB/km maximum	-	-	-
Signal-Inputs/outputs			
Operating voltage of signaling contacts at DC rated value	24 V	24 V	24 V
Operating current of signaling contacts at DC maximum	0.1 A	0.1 A	0.1 A
Supply voltage, current consumption, power loss			
Type of supply voltage	DC	DC	DC
Supply voltage for DC			
• rated value	24 V	24 V	24 V
• minimum	18.8 V	18.8 V	18.8 V
• maximum	28.8 V	28.8 V	28.8 V
Product component fusing at power supply input	Yes	Yes	Yes
Type of fusing at input for supply voltage	-	-	-
Consumed current At 24 V with DC maximum	0.2 A	0.2 A	0.2 A
Active power loss at 24 V for DC	-	-	-

Technical specifications (continued)

Article No.	6GK1503-2CB00	6GK1503-3CB00	6GK1503-4CB00
Product-type designation	PROFIBUS OLM G11	PROFIBUS OLM G12	PROFIBUS OLM G22
Permitted ambient conditions			
Ambient temperature			
• during operating	0 ... 60 °C	0 ... 60 °C	0 ... 60 °C
• during storage	-40 ... +70 °C	-40 ... +70 °C	-40 ... +70 °C
• during transport	-40 ... +70 °C	-40 ... +70 °C	-40 ... +70 °C
Relative humidity at 25 °C without condensation during operating maximum	95 %	95 %	95 %
Protection class IP	IP40	IP40	IP40
Design, dimensions and weight			
Design	compact	compact	compact
Width	39.5 mm	39.5 mm	39.5 mm
Height	112 mm	112 mm	112 mm
Depth	74.5 mm	74.5 mm	74.5 mm
Net weight	340 g	340 g	340 g
Mounting type			
• 35 mm DIN rail mounting	Yes	Yes	Yes
• wall mounting	Yes	Yes	Yes
Product properties, functions, components general			
Product function Ring redundancy	Yes	Yes	Yes
Standards, specifications, approvals			
Standard			
• for EMC from FM	FM3611: Class 1, Divison 2, Group A, B, C, D / T4, Class 1, Zone 2, Group IIC, T4	FM3611: Class 1, Divison 2, Group A, B, C, D / T4, Class 1, Zone 2, Group IIC, T4	FM3611: Class 1, Divison 2, Group A, B, C, D / T4, Class 1, Zone 2, Group IIC, T4
• for hazardous zone	EN 60079-0: 2006, EN60079-15: 2005, EN60079-28: 2007, II 3 (2) G Ex nA [opis] IIC T4 KEMA 09 ATEX 0173X	EN 60079-0: 2006, EN60079-15: 2005, EN60079-28: 2007, II 3 (2) G Ex nA [opis] IIC T4 KEMA 09 ATEX 0173X	EN 60079-0: 2006, EN60079-15: 2005, EN60079-28: 2007, II 3 (2) G Ex nA [opis] IIC T4 KEMA 09 ATEX 0173X
• for safety of CSA and UL	UL 60950-1, CSA C22.2 Nr. 60950-1	UL 60950-1, CSA C22.2 Nr. 60950-1	UL 60950-1, CSA C22.2 Nr. 60950-1
• for hazardous area of CSA and UL	UL 1604 and UL 2279-15 (Hazardous Location), CSA C22.2 No. 213-M1987, Class 1 / Division 2 / Group A, B, C, D / T4, Class 1 / Zone 2 / Group IIC / T4	UL 1604 and UL 2279-15 (Hazardous Location), CSA C22.2 No. 213-M1987, Class 1 / Division 2 / Group A, B, C, D / T4, Class 1 / Zone 2 / Group IIC / T4	UL 1604 and UL 2279-15 (Hazardous Location), CSA C22.2 No. 213-M1987, Class 1 / Division 2 / Group A, B, C, D / T4, Class 1 / Zone 2 / Group IIC / T4
• for emitted interference	EN 61000-6-4 (Class A)	EN 61000-6-4 (Class A)	EN 61000-6-4 (Class A)
• for interference immunity	EN 61000-6-2	EN 61000-6-2	EN 61000-6-2
Verification of suitability	EN 61000-6-2, EN 61000-6-4	EN 61000-6-2, EN 61000-6-4	EN 61000-6-2, EN 61000-6-4
• CE mark	Yes	Yes	Yes
• C-Tick	Yes	Yes	Yes
Marine classification association			
• American Bureau of Shipping Europe Ltd. (ABS)	Yes	Yes	Yes
• Bureau Veritas (BV)	Yes	Yes	Yes
• Det Norske Veritas (DNV)	Yes	Yes	Yes
• Germanische Lloyd (GL)	Yes	Yes	Yes
• Lloyds Register of Shipping (LRS)	Yes	Yes	Yes
• Nippon Kaiji Kyokai (NK)	Yes	Yes	Yes

PROFIBUS

Optical networks with OLM

OLM Optical Link Module

Technical specifications (continued)

Article No.	6GK1503-2CC00	6GK1503-3CC00	6GK1503-3CD00
Product-type designation	PROFIBUS OLM G11-1300	PROFIBUS OLM G12-1300	PROFIBUS OLM G12 EEC
Transmission rate			
Transfer rate			
• with PROFIBUS	9.6 kbit/s ... 12 Mbit/s	9.6 kbit/s ... 12 Mbit/s	9.6 kbit/s ... 12 Mbit/s
• With PROFIBUS PA	45.45 kbit/s	45.45 kbit/s	45.45 kbit/s
Interfaces			
Number of electrical/optical connections for network components or terminal equipment maximum	2	3	3
Number of electrical connections			
• for network components and terminal equipment	1	1	1
• for measuring instrument	1	1	1
• for signaling contact	1	1	1
• for power supply	1	1	1
• for redundant power supply	1	1	1
Design of electrical connection			
• for network components and terminal equipment	9-pin Sub-D socket	9-pin Sub-D socket	9-pin Sub-D socket
• for measuring device	2-pole terminal block	2-pole terminal block	2-pole terminal block
• for power supply and signaling contact	5-pole terminal block	5-pole terminal block	5-pole terminal block
Number of optical interfaces for optical waveguide	1	2	2
Design of the optical interface for optical waveguide	BFOC port	BFOC port	BFOC port
Optical data			
Damping ratio of FOC transmission link			
• for glass FOC with 10/125 µm or 9/125 µm at 0.5 dB/km maximum	8 dB	8 dB	-
• for glass FOC with 50/125 µm at 3 dB/km maximum	-	-	10 dB
• for glass FOC with 62.5/125 µm			
- at 1 dB/km maximum	-	-	-
- at 3.5 dB/km maximum	-	-	12 dB
• for PCF FOC with 200/230 µm at 10 dB/km	-	-	-
• for POF FOC with 980/1 000 µm at 230 dB/km	-	-	-
Signal delay time in bit time	6.5 bit	6.5 bit	6.5 bit
Injectable optical power relating to 1 mW			
• for glass FOC with 10/125 µm or 9/125 µm at 0.5 dB/km	-19 dB	-19 dB	-
• for glass FOC with 50/125 µm at 3 dB/km	-	-	-16 dB
• for glass FOC with 62.5/125 µm			
- at 1 dB/km	-	-	-
- at 3.5 dB/km	-	-	-13 dB
• of FOC transmission link			
- for PCF FOC with 200/230 µm at 10 dB/km	-	-	-
- for POF FOC with 980/1 000 µm at 230 dB/km	-	-	-

Technical specifications (continued)

Article No.	6GK1503-2CC00	6GK1503-3CC00	6GK1503-3CD00
Product-type designation	PROFIBUS OLM G11-1300	PROFIBUS OLM G12-1300	PROFIBUS OLM G12 EEC
Optical sensitivity relating to 1 mW			
• for glass FOC with 10/125 µm or 9/125 µm at 0.5 dB/km	-29 dB	-29 dB	-
• for glass FOC with 50/125 µm at 3 dB/km	-	-	-28 dB
• for glass FOC with 62.5/125 µm			
- at 1 dB/km	-	-	-
- at 3.5 dB/km	-	-	-28 dB
• of FOC transmission link			
- for PCF FOC with 200/230 µm at 10 dB/km	-	-	-
- for POF FOC with 980/1 000 µm at 230 dB/km	-	-	-
Wavelength			
• for glass FOC with 10/125 µm or 9/125 µm compatible with interface at 0.5 dB/km	1 310 nm	1 310 nm	-
• for glass FOC with 50/125 µm compatible with interface at 3 dB/km	-	-	860 nm
• for glass FOC with 62.5/125 µm compatible with interface			
- at 1 dB/km	-	-	-
- at 3.5 dB/km	-	-	860 nm
• of FOC transmission link			
- for PCF FOC with 200/230 µm at 10 dB/km	-	-	-
- for POF FOC with 980/1 000 µm at 230 dB/km	-	-	-
Cable length			
• for glass FOC with 10/125 µm or 9/125 µm at 0.5 dB/km maximum	15 km	15 km	-
• for glass FOC with 50/125 µm at 3 dB/km maximum	-	-	3 km
• for glass FOC with 62.5/125 µm at 1 dB/km maximum	-	-	-
• for glass FOC with 62.5/125 µm at 3.5 dB/km maximum	-	-	3 km
• for PCF FOC with 200/230 µm at 10 dB/km maximum	-	-	-
• for POF FOC with 980/1 000 µm at 230 dB/km maximum	-	-	-
Signal-Inputs/outputs			
Operating voltage of signaling contacts at DC rated value	24 V	24 V	24 V
Operating current of signaling contacts at DC maximum	0.1 A	0.1 A	0.1 A
Supply voltage, current consumption, power loss			
Type of supply voltage	DC	DC	DC
Supply voltage for DC			
• rated value	24 V	24 V	24 V
• minimum	18.8 V	18.8 V	18.8 V
• maximum	28.8 V	28.8 V	28.8 V
Product component fusing at power supply input	Yes	Yes	Yes
Type of fusing at input for supply voltage	-	-	-
Consumed current At 24 V with DC maximum	0.2 A	0.2 A	0.2 A
Active power loss at 24 V for DC	-	-	-

PROFIBUS

Optical networks with OLM

OLM Optical Link Module

Technical specifications (continued)

Article No.	6GK1503-2CC00	6GK1503-3CC00	6GK1503-3CD00
Product-type designation	PROFIBUS OLM G11-1300	PROFIBUS OLM G12-1300	PROFIBUS OLM G12 EEC
Permitted ambient conditions			
Ambient temperature			
• during operating	0 ... 60 °C	0 ... 60 °C	-25 ... +60 °C
• during storage	-40 ... +70 °C	-40 ... +70 °C	-40 ... +70 °C
• during transport	-40 ... +70 °C	-40 ... +70 °C	-40 ... +70 °C
Relative humidity at 25 °C without condensation during operating maximum	95 %	95 %	95 %
Protection class IP	IP40	IP40	IP40
Design, dimensions and weight			
Design	compact	compact	compact
Width	39.5 mm	39.5 mm	39.5 mm
Height	112 mm	112 mm	112 mm
Depth	74.5 mm	74.5 mm	74.5 mm
Net weight	340 g	340 g	340 g
Mounting type			
• 35 mm DIN rail mounting	Yes	Yes	Yes
• wall mounting	Yes	Yes	Yes
Product properties, functions, components general			
Product function Ring redundancy	Yes	Yes	Yes
Standards, specifications, approvals			
Standard			
• for EMC from FM	FM3611: Class 1, Division 2, Group A, B, C, D / T4, Class 1, Zone 2, Group IIC, T4	FM3611: Class 1, Division 2, Group A, B, C, D / T4, Class 1, Zone 2, Group IIC, T4	FM3611: Class 1, Division 2, Group A, B, C, D / T4, Class 1, Zone 2, Group IIC, T4
• for hazardous zone	EN 60079-0: 2006, EN60079-15: 2005, II 3 G Ex nA II T4 KEMA 07 ATEX 0003X	EN 60079-0: 2006, EN60079-15: 2005, II 3 G Ex nA II T4 KEMA 07 ATEX 0003X	EN 60079-0: 2006, EN60079-15: 2005, EN60079-28: 2007, II 3 (2) G Ex nA [opis] IIC T4 KEMA 09 ATEX 0173X
• for safety of CSA and UL	UL 60950-1, CSA C22.2 Nr. 60950-1	UL 60950-1, CSA C22.2 Nr. 60950-1	UL 60950-1, CSA C22.2 Nr. 60950-1
• for hazardous area of CSA and UL	UL 1604 and UL 2279-15 (Hazardous Location), CSA C22.2 No. 213-M1987, Class 1 / Division 2 / Group A, B, C, D / T4, Class 1 / Zone 2 / Group IIC / T4	UL 1604 and UL 2279-15 (Hazardous Location), CSA C22.2 No. 213-M1987, Class 1 / Division 2 / Group A, B, C, D / T4, Class 1 / Zone 2 / Group IIC / T4	UL 1604 and UL 2279-15 (Hazardous Location), CSA C22.2 No. 213-M1987, Class 1 / Division 2 / Group A, B, C, D / T4, Class 1 / Zone 2 / Group IIC / T4
• for emitted interference	EN 61000-6-4 (Class A)	EN 61000-6-4 (Class A)	EN 61000-6-4 (Class A)
• for interference immunity	EN 61000-6-2	EN 61000-6-2	EN 61000-6-2
Verification of suitability	EN 61000-6-2, EN 61000-6-4	EN 61000-6-2, EN 61000-6-4	EN 61000-6-2, EN 61000-6-4
• CE mark	Yes	Yes	Yes
• C-Tick	Yes	Yes	Yes
Marine classification association			
• American Bureau of Shipping Europe Ltd. (ABS)	Yes	Yes	Yes
• Bureau Veritas (BV)	Yes	Yes	Yes
• Det Norske Veritas (DNV)	Yes	Yes	Yes
• Germanische Lloyd (GL)	Yes	Yes	Yes
• Lloyds Register of Shipping (LRS)	Yes	Yes	Yes
• Nippon Kaiji Kyokai (NK)	Yes	Yes	Yes

Ordering data	Article No.	Ordering data	Article No.
PROFIBUS OLM/P11 Optical link module with 1 x RS 485 and 1 x plastic fiber-optic interface (2 BFOC sockets), with signaling contact and measuring output incl. 2 BFOC plugs for plastic fiber-optic cables	6GK1503-2CA00	PROFIBUS OLM/G11-1300 Optical link module with 1 x RS 485 and 1 x glass fiber-optic interface (2 BFOC sockets), 1 300 nm wavelength for large distances up to 15 km, with signaling contact and measuring output	6GK1503-2CC00
PROFIBUS OLM/P12 Optical link module with 1 x RS 485 and 2 x plastic fiber-optic interface (4 BFOC sockets), with signaling contact and measuring output incl. 4 BFOC plugs for plastic fiber-optic cables	6GK1503-3CA00	PROFIBUS OLM/G12-1300 Optical link module with 1 x RS 485 and 2 x glass fiber-optic interface (4 BFOC sockets), 1 300 nm wavelength for large distances up to 15 km, with signaling contact and measuring output	6GK1503-3CC00
PROFIBUS OLM/P22 Optical link module with 2 x RS 485 and 2 x plastic fiber-optic interface (4 BFOC sockets), with signaling contact and measuring output incl. 4 BFOC plugs for plastic fiber-optic cables	6GK1503-4CA00	PROFIBUS OLM/G12 EEC Optical link module with 1 x RS 485 and 2 x glass fiber-optic interface (4 BFOC sockets), for standard distances up to 3 000 m, for extended temperature range -25 °C to +60 °C, with signaling contact and measuring output	6GK1503-3CD00
PROFIBUS OLM/G11 Optical link module with 1 x RS 485 and 1 x glass fiber-optic interface (2 BFOC sockets), for standard distances, with signaling contact and measuring output	6GK1503-2CB00	PROFIBUS OLM mounting plate For wall mounting of PROFIBUS OLM V4	6GK1503-8AA00
PROFIBUS OLM/G12 Optical link module with 1 x RS 485 and 2 x glass fiber-optic interface (4 BFOC sockets), for standard distances up to 3 000 m, with signaling contact and measuring output	6GK1503-3CB00	SITOP compact 24 V/ 0.6 A 1-phase power supply with wide-range input 85 – 264 V AC/110 – 300 V DC, stabilized output voltage 24 V, rated output current value 0.6 A, slim design	6EP1331-5BA00
PROFIBUS OLM/G22 Optical link module with 2 x RS 485 and 2 x glass fiber-optic interface (4 BFOC sockets), for standard distances up to 3 000 m, with signaling contact and measuring output	6GK1503-4CB00		

PROFIBUS

Optical networks with OBT and integrated interface

Plastic and PCF fiber-optic cable

Overview



- Electrical isolation of DP devices
- Protection of the transmission path against electromagnetic interference
- Up to 50 m cable length with plastic fiber-optic cables and up to 300 m with PCF fiber-optic cables
- Rugged fiber-optic standard cables, designed for industrial applications
- Hybrid cable for the shared transmission of data and power supply
- Extensive approvals (UL)

Benefits



- Plastic and PCF fiber-optic cables can be pre-assembled on site
- Easy connector assembly on site
- Time savings on start-up thanks to pre-assembled cables
- Protection of the transmission path against electromagnetic interference
- Tap-proof, because the cable does not radiate
- A cable for the shared transmission of data and power

Application

SIMATIC NET plastic and PCF fiber-optic conductors are used to construct optical indoor PROFIBUS DP networks.

Plastic fiber-optic cables and segmented PCF fiber-optic cables can be assembled easily on site with 2 x 2 simplex plugs. The maximum cable length between two DP devices is 50 m.

Longer cable lengths up to 300 m can be achieved using PCF fiber-optic cables. These cables are also available preassembled with 4 simplex plugs.

Devices with integrated optical interface (Simplex connection technology) include, for example, OBT, CP 342-5 FO, CP 5613 FO, IM 153-2 FO, IM 467 FO.

Design

Different types of plastic and PCF fiber-optic cables are offered:

- **Plastic FOC, duplex core;**
Two flat cores with PVC inner sheath and without outer sheath for indoor applications with low mechanical stress such as laboratory setups or inside cabinets. Cable lengths up to 50 m.
- **Plastic FOC, standard cable;**
Rugged round cable with violet PVC outer sheath and Kevlar tension components as well as two plastic fibers with a rugged polyamide inner sheath. For indoor applications with cable lengths up to 50 m.
- **PCF fiber-optic cable, standard cables:**
 - PCF Fiber Optic standard cable;
rugged round cable with violet PVC outer sheath and Kevlar tension components for indoor applications with cable lengths of up to 300 m.
The cable is not suitable for assembly in the field (only available pre-assembled with an insertion tool)
 - PCF Standard Cable GP (general purpose);
rugged round cable with green PVC outer sheath and Kevlar tension elements for indoor and outdoor applications with cable lengths of up to 300 m;
the cable is suitable for assembly in the field.
- **PCF fiber-optic trailing cable;**
Rugged round cable with green outer sheath and Kevlar tension elements for trailing cable applications with cable lengths of up to 300 m. The cable is suitable for assembly in the field.
Two cable variants are available for this application:
 - PCF Trailing Cable;
cable for high mechanical stress, PUR outer sheath, no UL approval
 - PCF Trailing Cable GP (general purpose);
cable for low mechanical stress, PVC outer sheath, with UL approval

Technical specifications

Article No.	6XV1821-2AN50	6XV1821-0AH10	6XV1821-1CN50
Product-type designation	PROFIBUS Plastic Fiber Optic Duplex Core	PROFIBUS Plastic Fiber Optic standard cable	PROFIBUS PCF Fiber Optic standard cable
Product description	Fiber-optic cable with polyoptical fiber (flat dual cores), 50m ring, unassembled	Fiber-optic cable with polyoptical fiber, sold by the meter, unassembled	PCF fiber-optic cable with plastic cladding, preferred length, preassembled
Acceptability for application	Indoor applications with low mechanical stress (e.g. laboratory setups or within cabinets), cable lengths up to 50 m	Cable for indoor applications	Cable for indoor applications
Version of the assembled FO cable	Can be fitted with four Simplex connectors	Can be fitted with four Simplex connectors	Can be fitted with four Simplex connectors
Cable designation	V-2Y 2x1 P 980/1 000	I-V4Y(ZN)Y 2P 980/1 000	I-V(ZN)Y 2K 200/230
Cable length	50 m	-	50 m
Optical data			
Damping ratio per length at 650 nm maximum	0.01 dB/m	0.16 dB/m	0.01 dB/m
Bandwidth length product at 650 nm	1 GHz·m	1 GHz·m	17 GHz·m
Mechanical data			
Number of fibers per FOC core	1	1	1
Number of FOC cores per FOC cable	2	2	2
Version of the FO conductor fiber	Step index fiber 980/1 000 µm	Step index fiber 980/1 000 µm	Step index fiber 200/230 µm
Design of the FOC core	-	-	-
Design of the fiber-optic cable	-	-	-
Outer diameter			
• of optical fibers	980 µm	980 µm	200 µm
• of the optical fiber sheath	1 000 µm	1 000 µm	230 µm
• of the FOC core sheath	2.2 mm	2.2 mm	2.2 mm
• of the cable	-	7.8 mm	4.7 mm
Symmetrical deviation			
• of the outer diameter of the FOC core sheath	0.1 mm	0.1 mm	0.1 mm
• of the outer diameter of the line	-	0.3 mm	-
Width of the cable sheath	-	-	-
Symmetrical tolerance of width of cable sheath	-	-	-
Thickness of the cable sheath	-	-	-
Symmetrical tolerance of thickness of cable sheath	-	-	-
Material			
• of the fiber-optic cable core	Polymethylmethacrylate (PMMA)	Polymethylmethacrylate (PMMA)	Quartz glass
• of the optical fiber sheath	Fluoridated special polymer	Fluoridated special polymer	Fluoridated special polymer
• of the FOC core sheath	PE	PA	PVC
• of the fiber-optic cable sheath	-	PVC	PVC
• of the strain relief	-	Kevlar fibers	Kevlar fibers
Color			
• of the FOC core sheath	Gray	Orange/black	Orange/black
• of the cable sheath	-	Violet	Violet

PROFIBUS

Optical networks with OBT and integrated interface

Plastic and PCF fiber-optic cable

Technical specifications (continued)

Article No.	6XV1821-2AN50	6XV1821-0AH10	6XV1821-1CN50
Product-type designation	PROFIBUS Plastic Fiber Optic Duplex Core	PROFIBUS Plastic Fiber Optic standard cable	PROFIBUS PCF Fiber Optic standard cable
Bending radius			
• with single bend minimum permissible	25 mm	100 mm	47 mm
• with multiple bends minimum permissible	25 mm	150 mm	70 mm
• with continuous bending	-	-	-
Number of bending cycles	-	-	-
Number of torsion cycles in the case of torsion by $\pm 360^\circ$ on 1 m cable length	-	-	-
Traction stress maximum	10 N	100 N	200 N
Short-term shear force per length	30 N/cm	100 N/cm	100 N/cm
Continuous lateral force per length	400 N/m	-	-
Weight per length	7.6 kg/km	65 kg/km	22 kg/km
Permitted ambient conditions			
Ambient temperature			
• during operating	-55 ... +85 °C	-30 ... +70 °C	-30 ... +70 °C
• during storage	-55 ... +85 °C	-30 ... +70 °C	-30 ... +70 °C
• during transport	-55 ... +85 °C	-30 ... +70 °C	-30 ... +70 °C
• during installation	-5 ... +50 °C	-5 ... 50 °C	-5 ... +50 °C
Ambient condition for (standard) operation mode	-	-	-
Protection class IP	-	-	IP20
Burning behaviour	flame-retardant in accordance with flame test VW-1 acc. to UL 1581	flame resistant according to IEC 60332-1-2	flame resistant according to IEC 60332-1-2
Chemical resistance			
• to mineral oil	Conditional resistance	Conditional resistance	Conditional resistance
• to grease	Conditional resistance	Conditional resistance	Conditional resistance
• to water	-	-	-
Radiological resistance to UV radiation	Not resistant	Not resistant	Not resistant
Product properties, functions, components general			
Product feature			
• halogen-free	Yes	No	No
• silicon-free	Yes	Yes	Yes
Product component Rodent protection	No	No	No
Cable length for POF FOC			
• for Industrial Ethernet maximum	-	-	-
• for PROFIBUS maximum	80 m	80 m	-
Standards, specifications, approvals			
Verification of suitability	-	UL approval: OFN (NEC Article 770, UL 1651) / CSA approval: OFN (CSA standard C22.2 No232-M1988)	-
• RoHS conformity	Yes	Yes	Yes

Technical specifications (continued)

Article No.	6XV1861-2A	6XV1861-2C	6XV1861-2D
Product-type designation	PCF Standard Cable GP	PCF Trailing Cable	PCF Trailing Cable GP
Product description	PCF fiber-optic cable with plastic cladding, sold by the meter, unassembled	PCF fiber-optic cable with plastic cladding, sold by the meter, unassembled	PCF fiber-optic cable with plastic cladding, sold by the meter, unassembled
Acceptability for application	Cable for fixed installation for indoor and outdoor use, UL approval	Cable for use with high mechanical stress and moving applications (e.g. trailing cables), without UL approval	Cable for use with high mechanical stress and moving applications (e.g. trailing cables), UL approval
Version of the assembled FO cable	Can be fitted with SC RJ, SC RJ Plug PRO, BFOC and Simplex connectors	Can be fitted with SC RJ, SC RJ Plug PRO, BFOC and Simplex connectors	Can be fitted with SC RJ, SC RJ Plug PRO, BFOC and Simplex connectors
Cable designation	AT-V(ZN)YY 2K 200/230	AT-V(ZN)Y(ZN)11Y 2K 200/230	AT-V(ZN)Y(ZN)Y 2K 200/230
Cable length	-	-	-
Optical data			
Damping ratio per length at 660 nm maximum	10 dB/km	10 dB/km	10 dB/km
Bandwidth length product at 650 nm	17 GHz·m	17 GHz·m	17 GHz·m
Mechanical data			
Number of fibers per FOC core	1	1	1
Number of FOC cores per FOC cable	2	2	2
Version of the FO conductor fiber	Step index fiber 200/230 µm	Step index fiber 200/230 µm	Step index fiber 200/230 µm
Design of the FOC core	-	-	-
Design of the fiber-optic cable	-	-	-
Outer diameter			
• of optical fibers	200 µm	200 µm	200 µm
• of the optical fiber sheath	230 µm	230 µm	230 µm
• of the FOC core sheath	2.2 mm	2.2 mm	2.2 mm
• of the cable	7.2 mm	8.8 mm	8.8 mm
Symmetrical deviation			
• of the outer diameter of the FOC core sheath	0.1 mm	0.1 mm	0.1 mm
• of the outer diameter of the line	0.5 mm	0.5 mm	0.5 mm
Width of the cable sheath	-	-	-
Symmetrical tolerance of width of cable sheath	-	-	-
Thickness of the cable sheath	-	-	-
Symmetrical tolerance of thickness of cable sheath	-	-	-
Material			
• of the fiber-optic cable core	Quartz glass	Quartz glass	Quartz glass
• of the optical fiber sheath	Special polymer	Special polymer	Special polymer
• of the FOC core sheath	PVC	PVC	PVC
• of the fiber-optic cable sheath	PVC	PUR	PVC
• of the strain relief	Aramide fibers	Aramide fibers	Aramide fibers
Color			
• of the FOC core sheath	Orange/black	Orange/black	Orange/black
• of the cable sheath	green	green	green
Bending radius			
• with single bend minimum permissible	70 mm	130 mm	130 mm
• with multiple bends minimum permissible	105 mm	175 mm	175 mm
• with continuous bending	-	-	-
Number of bending cycles	-	5 000 000	5 000 000
Number of torsion cycles in the case of torsion by ± 360° on 1 m cable length	-	-	-
Traction stress maximum	100 N	800 N	800 N
Short-term shear force per length	500 N/cm	500 N/cm	500 N/cm
Continuous lateral force per length	300 N/cm	300 N/cm	300 N/cm
Weight per length	45 kg/km	85 kg/km	85 kg/km

PROFIBUS

Optical networks with OBT and integrated interface

Plastic and PCF fiber-optic cable

Technical specifications (continued)

Article No.	6XV1861-2A	6XV1861-2C	6XV1861-2D
Product-type designation	PCF Standard Cable GP	PCF Trailing Cable	PCF Trailing Cable GP
Permitted ambient conditions			
Ambient temperature			
• during operating	-40 ... +90 °C	-25 ... +75 °C	-25 ... +75 °C
• during storage	-40 ... +90 °C	-30 ... +75 °C	-30 ... +75 °C
• during transport	-40 ... +90 °C	-30 ... +75 °C	-30 ... +75 °C
• during installation	-5 ... +50 °C	-5 ... +50 °C	-5 ... +50 °C
Ambient condition for (standard) operation mode	-	-	-
Protection class IP	-	-	-
Burning behaviour	flame resistant according to IEC 60332-1-2 and IEC 60332-3-22 (Cat. A)	flame-retardant	flame resistant according to IEC 60332-1-2 and IEC 60332-3-22 (Cat. A)
Chemical resistance			
• to mineral oil	Conditional resistance	resistant	Conditional resistance
• to grease	Conditional resistance	resistant	Conditional resistance
• to water	Conditional resistance	Conditional resistance	Conditional resistance
Radiological resistance to UV radiation	resistant	resistant	resistant
Product properties, functions, components general			
Product feature			
• halogen-free	No	No	No
• silicon-free	Yes	Yes	Yes
Product component Rodent protection	No	No	No
Cable length for PCF FOC			
• for Industrial Ethernet maximum	100 m	100 m	100 m
• for PROFIBUS maximum	400 m	400 m	400 m
Standards, specifications, approvals			
Verification of suitability	UL approval: OFN (NEC Article 770, UL 1651) / CSA approval: OFN 90 Cel, FT1, FT4 (CSA standard C22.2 No232-M1988)	-	UL approval: OFN (NEC Article 770, UL 1651) / CSA approval: OFN 90 Cel, FT1, FT4 (CSA standard C22.2 No232-M1988)
• RoHS conformity	Yes	Yes	Yes

Ordering data

Ordering data	Article No.	Ordering data	Article No.
PROFIBUS Plastic Fiber Optic standard cable Rugged round cable with 2 plastic fiber-optic cores, PVC outer sheath and PA inner sheath, for indoor use; without connector <ul style="list-style-type: none"> Sold by the meter 50 m ring 100 m ring 	6XV1821-0AH10 6XV1821-0AN50 6XV1821-0AT10	PROFIBUS Plastic Fiber Optic stripping tool set Tools for removing the outer sheath or core sheath of Plastic Fiber Optic cables	6GK1905-6PA10
PROFIBUS Plastic Fiber Optic duplex core Plastic fiber-optic cable with 2 cores, PVC outer sheath, for use in environments with low mechanical stress; without connector <ul style="list-style-type: none"> 50 m ring 	6XV1821-2AN50	PROFIBUS PCF Fiber Optic standard cable PCF fiber-optic cable with 2 cores, PVC outer sheath, for covering larger distances up to 300 m, for connecting devices to the optical PROFIBUS DP <u>Preferred lengths</u> Precut/preassembled with 2 × 2 Simplex connectors, arm length 30 cm each, with aid for pulling in at one end <ul style="list-style-type: none"> 50 m 75 m 100 m 150 m 200 m 250 m 300 m 	6XV1821-1CN50 6XV1821-1CN75 6XV1821-1CT10 6XV1821-1CT15 6XV1821-1CT20 6XV1821-1CT25 6XV1821-1CT30
PROFIBUS Plastic Fiber Optic simplex plug/polishing set 100 simplex connectors and 5 polishing sets for assembling PROFIBUS plastic fiber optic cables for the optical PROFIBUS DP	6GK1901-0FB00-0AA0		

Ordering data	Article No.		Article No.
PROFIBUS PCF Standard Cable GP 200/230 Standard cable, segmentable, sold by the meter; max. quantity 2 000 m; minimum order 20 m; Preferred lengths; pre-assembled with 4 Simplex connectors <ul style="list-style-type: none"> • 50 m • 75 m • 100 m • 150 m • 200 m • 250 m • 300 m 	6XV1861-2A 6XV1861-7AN50 6XV1861-7AN75 6XV1861-7AT10 6XV1861-7AT15 6XV1861-7AT20 6XV1861-7AT25 6XV1861-7AT30	Plug-in adapter For assembling the plastic Simplex connector in combination with IM 467 FO, CP 342-5 FO, IM 151 FO and IM 153-2 FO, 50 units Termination Kit for Simplex Plug Assembly case for local assembly of PCF Simplex connectors; comprising a stripping tool, buffer stripping tool, Kevlar cutters, fiber breaking tool, crimping tool and microscope Termination Kit for BFOC Plug Assembly case for local assembly of BFOC connectors; comprising a stripping tool, buffer stripping tool, Kevlar cutters, fiber breaking tool, and microscope Simplex Plug Crimp connector with cleaning materials; 50 connectors for assembly on PCF fiber-optic cables on site BFOC Plug Screw connector with cleaning materials; 20 connectors for assembly on PCF fiber-optic cables on site SIMATIC NET Manual Collection Electronic manuals for communication systems, communication protocols, and communication products; on DVD; German/English	6ES7195-1BE00-0XA0 6GK1900-0KL00-0AA0 6GK1900-0HL00-0AA0 6GK1900-0KB00-0AC0 6GK1900-0HB00-0AC0 6GK1975-1AA00-3AA0
PROFIBUS PCF Trailing Cable 200/230 Trailing cable, segmentable, sold by the meter; max. quantity 2 000 m; minimum order 20 m; Preferred lengths; pre-assembled with 4 Simplex connectors <ul style="list-style-type: none"> • 50 m • 75 m • 100 m • 150 m • 200 m • 250 m • 300 m 	6XV1861-2C 6XV1861-7CN50 6XV1861-7CN75 6XV1861-7CT10 6XV1861-7CT15 6XV1861-7CT20 6XV1861-7CT25 6XV1861-7CT30		
PROFIBUS PCF Trailing Cable GP 200/230 Trailing cable, segmentable, sold by the meter; max. length 2 000 m; minimum order quantity 20 m; Preferred lengths; pre-assembled with 4 Simplex connectors <ul style="list-style-type: none"> • 50 m • 75 m • 100 m • 150 m • 200 m • 250 m • 300 m 	6XV1861-2D 6XV1861-7DN50 6XV1861-7DN75 6XV1861-7DT10 6XV1861-7DT15 6XV1861-7DT20 6XV1861-7DT25 6XV1861-7DT30		

More information

You can order components supplementary to the SIMATIC NET cabling range from your local contact.

Technical advice on this subject is available from:

J. Hertlein
 I IA SC CI PRM 4
 Phone: +49 (911) 750-4465
 E-mail: juergen.hertlein@siemens.com

PROFIBUS

Optical networks with OBT and integrated interface

PCF-FOC termination kit

Overview



- Compact, rugged assembly case for PCF fiber-optic cables
- Special versions for easy assembly of HP Simplex and BFOC plugs on PCF fiber-optic cables
- The quality of the assembly can be checked using the enclosed microscope

Benefits



- Easy installation of the unassembled cables in industrial plants
- Flexible assembly of connectors on PCF fiber-optic cables on site (HP Simplex, BFOC connectors)
- Mistakes are avoided with easy visual inspection of the assembled connector on site using a microscope
- PCF fiber-optic cables are easily repaired on site by installing a new PCF cable

Application

SIMATIC NET PCF fiber-optic conductors are used to construct optical indoor and outdoor PROFIBUS DP networks. They are easy to assemble on site with 2 x 2 Simplex connectors or 2 x 2 BFOC connectors. The maximum cable length between two DP devices is 300 m and between two OLMs 400 m.

PROFIBUS DP devices with integrated optical interface (Simplex connection technology) include, for example, OBT, CP 342-5 FO, CP 5613 FO, IM 153-2 FO, IM 467 FO.

Design

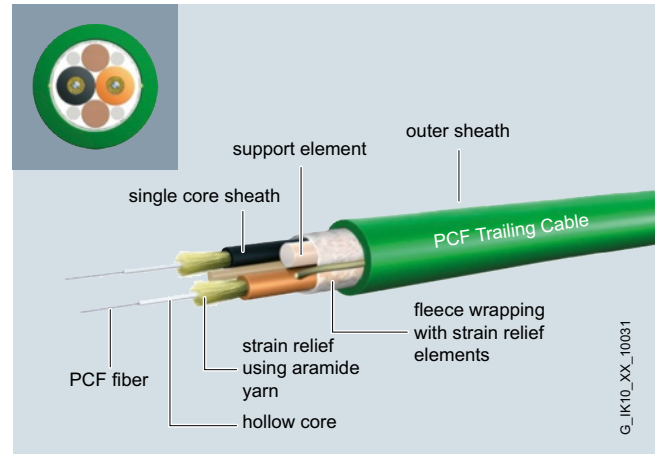

Two versions of the assembly case are available for PCF fiber-optic cables:

- Assembly case for HP Simplex connectors; for on-site pre-assembly of HP Simplex connectors; comprising a stripping tool, buffer stripping tool, Kevlar cutters, fiber breaking tool, crimping tool and microscope
- Assembly case for BFOC connectors; for on-site pre-assembly of BFOC connectors; comprising a stripping tool, buffer stripping tool, Kevlar cutters, fiber breaking tool and microscope

G_IK10_XX_10031

Technical specifications

Article No.	6GK1900-0KB00-0AC0	6GK1900-0HB00-0AC0
Product-type designation	PB Simplex Plug PCF	PB BFOC Plug PCF
Product description	Simplex crimp connector for PCF fiber-optic cables with plastic cladding	BFOC screw connector for PCF fiber-optic cables with plastic cladding
Acceptability for application	For connection of PCF fiber-optic cables	For connection of PCF fiber-optic cables
Transmission rate		
Transfer rate		
• 1 for Industrial Ethernet	-	-
• 2 for Industrial Ethernet	-	-
• 3 for Industrial Ethernet	-	-
• with PROFIBUS	9.6 kbit/s ... 12 Mbit/s	9.6 kbit/s ... 12 Mbit/s
Interfaces		
Number of optical interfaces for optical waveguide	1	1
Design of optical connections for network components or terminal devices	Simplex connector	BFOC connector
Design of the electrical connection FastConnect	No	No
Mechanical data		
Material of the enclosure	plastic	Metal and plastic
Design, dimensions and weight		
Type of cable outlet	180 degree cable outlet	180 degree cable outlet
Width	9.4 mm	10 mm
Height	6.1 mm	10 mm
Depth	29.9 mm	10 mm
Net weight	20 g	8 g
Permitted ambient conditions		
Protection class IP	IP20	IP20
Chemical resistance to water	-	-
Product properties, functions, components general		
Product feature silicon-free	Yes	Yes
Product component strain relief	Yes	Yes
Standards, specifications, approvals		
Verification of suitability RoHS conformity	Yes	Yes

PROFIBUS

Optical networks with OBT and integrated interface

PCF-FOC termination kit

Ordering data**Article No.****Termination Kit for Simplex connectors**

Assembly case for local assembly of PCF Simplex connectors; comprising a stripping tool, buffer stripping tool, Kevlar cutters, fiber breaking tool, crimping tool and microscope

6GK1900-0KL00-0AA0**Termination Kit for BFOC connectors**

Assembly case for local assembly of BFOC connectors; comprising a stripping tool, buffer stripping tool, Kevlar cutters, fiber breaking tool, and microscope

6GK1900-0HL00-0AA0**Connector****Simplex connector**

with cleaning materials; 50 crimp connectors for assembly on PCF fiber-optic cables on site

6GK1900-0KB00-0AC0**BFOC connector**

with cleaning materials; 20 screw connectors for assembly on PCF fiber-optic cables on site

6GK1900-0HB00-0AC0**More information**

You can order components supplementary to the SIMATIC NET cabling range from your local contact.

Technical advice on this subject is available from:

J. Hertlein
 I IA SC CI PRM 4
 Phone: +49 (911) 750-4465
 E-mail: juergen.hertlein@siemens.com

Overview



- For connecting a PROFIBUS station without an integrated fiber-optic cable interface or an RS 485 segment to an optical line
- Quick and easy installation of the plastic fiber-optic cable without the need for special tools

Benefits

get Designed for Industry

- Option of connecting existing devices or an RS 485 segment with electrical interface to the optical PROFIBUS
- "Socket outlet" for connecting mobile devices (e.g. programming devices) without interruption of the bus
- Time saved through simple and fast connector mounting without special tools

Application

The OBT (Optical Bus Terminal) is used to connect a PROFIBUS station without integral optical interface or a PROFIBUS DP RS485 segment to an optical line. Existing DP devices are then provided with the advantages of optical data transmission.

The PROFIBUS station is connected to the RS 485 interface of the OBT via a cable terminated at both ends, e.g. connecting cable 830-1T. The OBT is integrated into the optical line using two optical interfaces.

The following optical transmission media can be connected to the OBT:

- Plastic fiber-optic cables can be used up to an individual segment length of 50 m. They can be configured very easily on site with 2 x 2 Simplex connectors.
- PCF¹⁾ fiber-optic cables can be used for an individual segment length up to 300 m. These cables are preassembled. The OBT supports all PROFIBUS data transmission rates up to 12 Mbit/s.

¹⁾ Also known as HCS[®] fiber-optic cable:
HCS[®] is a registered trademark of Lucent Technologies.

Design

The OBT has a compact plastic housing. It is suitable for mounting on a DIN rail or for wall mounting with a mounting plate with the aid of two holes drilled right through.

The OBT has the following connections:

- 9-pin sub-D socket for connecting the PROFIBUS DP node such as programming device (PG), PC, operator panel (OP), S7-300 or nodes without integral optics, e.g. ET 200S or PROFIBUS DP components from other suppliers or a PROFIBUS DP-RS 485 segment.
- Two optical interfaces for the connection of plastic and PCF fiber-optic cables with Simplex connectors (connection to CP 342-5 FO, CP 5613 FO, IM 153-2 FO, IM 467 FO or to ET 200 with integrated optics)
- 24 V DC infeed for power supply

Function

- Connection of a station with RS 485 interface via connecting cable 830-1T or PROFIBUS cable with bus connectors (terminated at both ends) or an RS 485 segment
- Provision of an electrical connection point on the optical line (e.g. PG connection for startup and diagnostics).
- Support for all PROFIBUS data rates from 9.6 kbit/s to 12 Mbit/s including 45.45 kbit/s for PROFIBUS PA
- Regeneration of the signals in amplitude and time
- Cascade depth when using user-defined bus parameters up to 126 stations
- Galvanic isolation of the station via fiber optic cable
- Simple diagnostics via LED display for operating voltage as well as for receipt of data CH1, CH2 and CH3.

PROFIBUS

Optical networks with OBT and integrated interface

Optical bus terminal OBT

Integration

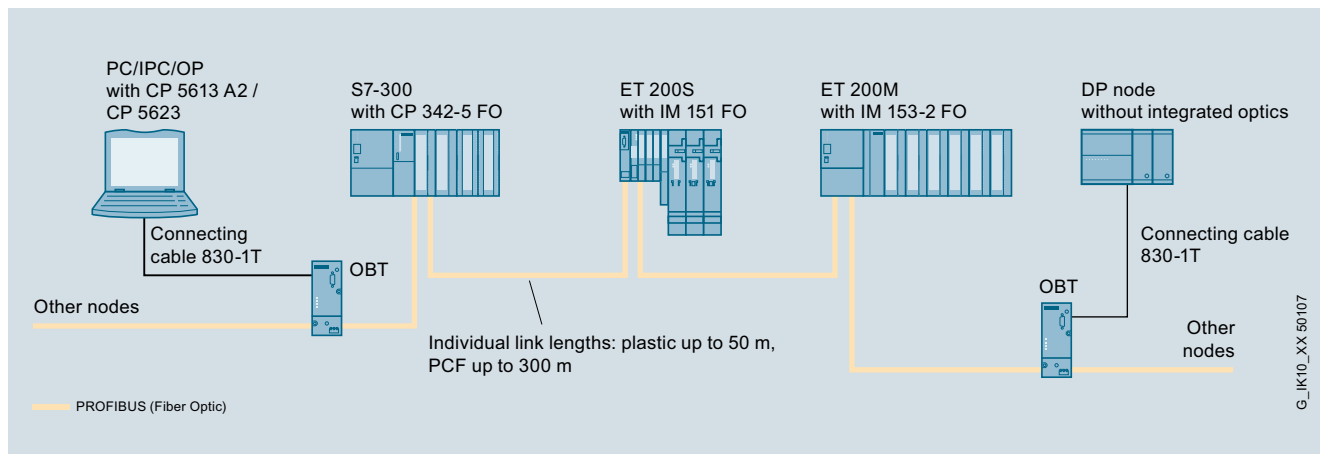

System configuration of optical PROFIBUS DP with PROFIBUS OBT

Technical specifications

Article No.	6GK1500-3AA10	Article No.	6GK1500-3AA10
Product-type designation	PROFIBUS OBT	Product-type designation	PROFIBUS OBT
Transmission rate		Optical sensitivity relating to 1 mW of FOC transmission link	
Transfer rate		• for PCF FOC with 200/230 µm at 10 dB/km	-22 dB
• with PROFIBUS	9.6 kbit/s ... 12 Mbit/s	• for POF FOC with 980/1 000 µm at 230 dB/km	-20 dB
• With PROFIBUS PA	45.45 kbit/s		
Interfaces		Wavelength of FOC transmission link	
Number of electrical/optical connections for network components or terminal equipment maximum	3	• for PCF FOC with 200/230 µm at 10 dB/km	660 nm
Number of electrical connections		• for POF FOC with 980/1 000 µm at 230 dB/km	660 nm
• for network components and terminal equipment	1		
• for power supply	1	Cable length	
Design of electrical connection		• for PCF FOC with 200/230 µm at 10 dB/km maximum	300 m
• for network components and terminal equipment	9-pin Sub-D socket	• for POF FOC with 980/1 000 µm at 230 dB/km maximum	50 m
• for power supply	3-pole terminal block		
Number of optical interfaces for optical waveguide	2	Supply voltage, current consumption, power loss	
Design of the optical interface for optical waveguide	Duplex port	Type of supply voltage	DC
Optical data		Supply voltage for DC	
Damping ratio of FOC transmission link		• rated value	24 V
• for PCF FOC with 200/230 µm at 10 dB/km	3 dB	• minimum	19.2 V
• for POF FOC with 980/1 000 µm at 230 dB/km	13 dB	• maximum	28.8 V
Signal delay time in bit time	6.5 bit	Product component fusing at power supply input	-
Injectable optical power relating to 1 mW of FOC transmission link		Type of fusing at input for supply voltage	-
• for PCF FOC with 200/230 µm at 10 dB/km	-16 dB	Consumed current At 24 V with DC maximum	-
• for POF FOC with 980/1 000 µm at 230 dB/km	-5.9 dB	Active power loss at 24 V for DC	-
		Permitted ambient conditions	
		Ambient temperature	
		• during operating	0 ... 60 °C
		• during storage	-40 ... +70 °C
		• during transport	-40 ... +70 °C
		Relative humidity at 25 °C without condensation during operating maximum	95 %
		Protection class IP	IP30

Technical specifications (continued)

Article No.	6GK1500-3AA10
Product-type designation	PROFIBUS OBT
Design, dimensions and weight	
Design	compact
Width	50.5 mm
Height	138 mm
Depth	78 mm
Net weight	400 g
Mounting type	
• 35 mm DIN rail mounting	Yes
• wall mounting	Yes
Standards, specifications, approvals	
Standard	
• for EMC from FM	FM3611: Class 1, Divison 2, Group A, B, C, D / T4, Class 1, Zone 2, Group IIC, T4
• for hazardous zone	EN 60079-0: 2006, EN60079-15: 2005, II 3 G Ex nA II T4 KEMA 07 ATEX 0145X
• for safety of CSA and UL	UL 60950-1, CSA C22.2 Nr. 60950-1
• for hazardous area of CSA and UL	-
• for emitted interference	EN 61000-6-4 (Class A)
• for interference immunity	EN 61000-6-2
Verification of suitability	EN 61000-6-2, EN 61000-6-4
• CE mark	Yes
• C-Tick	Yes
Marine classification association	
• American Bureau of Shipping Europe Ltd. (ABS)	No
• Bureau Veritas (BV)	No
• Det Norske Veritas (DNV)	No
• Germanische Lloyd (GL)	No
• Lloyds Register of Shipping (LRS)	No
• Nippon Kaiji Kyokai (NK)	No

Ordering data

Article No.

PROFIBUS OBT**6GK1500-3AA10**

Optical bus terminal for connecting a PROFIBUS node or an RS485 segment without an integrated optical interface to the optical PROFIBUS; without a Simplex connector

PROFIBUS plug-in cable 830-1T

For connecting a data terminal, completely pre-assembled with two sub-D connectors, 9-pin

- 1.5 m
- 3 m

6XV1830-1CH15
6XV1830-1CH30

SITOP compact 24 V/ 0.6 A

1-phase power supply with wide-range input 85 – 264 V AC/110 – 300 V DC, stabilized output voltage 24 V, rated output current value 0.6 A, slim design

6EP1331-5BA00

PROFIBUS

System interfaces for SIMATIC S7

Introduction

Overview

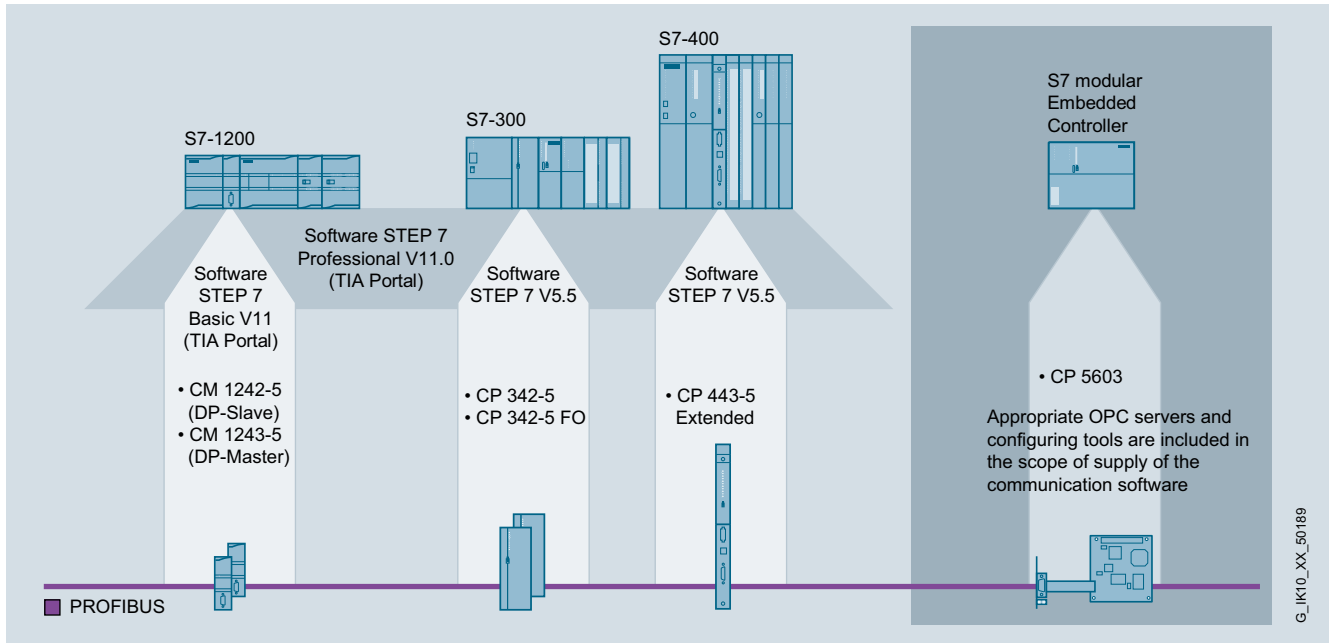

PROFIBUS communication for SIMATIC S7

The communication modules for SIMATIC open up further application cases through additional functions using CPs, such as Fiber Optic, as far as the terminal device. They also support versatile expansion of the SIMATIC with further communication interfaces for PROFIBUS as required, taking the load off the CPU.

Standard functions – PROFIBUS connection for any CPU

- CM 1242-5 and CM 1243-5 for SIMATIC S7-1200 for connection to PROFIBUS as DP slave or DP master
- CM 1542-5 for SIMATIC S7-1500 for connection to PROFIBUS as DP slave or DP master
- CP 342-5 for SIMATIC S7-300 for connection to PROFIBUS as DP master or DP slave
- CM 443-5 Extended for connection to PROFIBUS as DP master or DP slave
- Designed for use in harsh industrial environments
- Shipbuilding certification for use on ships and offshore units
- High-speed data transfer due to transfer rates of up to 12 Mbit/s

CPs with special functions

- CP 342-5 FO with integral optical interface for connecting the SIMATIC S7-300 to the optical PROFIBUS DP
- CP 1542-5 as entry-level module for connecting the S7-1500 to PROFIBUS with limited number of PROFIBUS DP slaves

Overview (continued)

Hardware	PROFIBUS DP			Open communication	S7 communication	PG/OP communication		Usage		Time		
	DP master cl.1	DP master cl.2	DP slave			Send/Receive	S7 routing	F system	H system	Sender	Receiver	Transfer
SIMATIC S7-1200	S7-1200 CPUs	No PB SS integrated !										
	CM 1243-5	• ¹⁾				•	•	•				
	CM 1242-5			•								
SIMATIC S7-1500	CPU 1511-1 PN	No PB SS integrated !										
	CPU 1513-1 PN	No PB SS integrated !										
	CPU 1516-3 PN/DP	•	•			•	•	•	• ³⁾		•	•
	CM 1542-5	•	•	•		•	•	•	•		•	•
	CP 1542-5	• ²⁾	•	•			•	•	•		•	•
SIMATIC S7-300	S7-300 CPUs	•	•	•		○	•		• ³⁾		•	•
	CP 343-5	•	•	•	•	•	•	•				
	CP 343-5 FO	•	•	•	•	•	•	•				
SIMATIC S7-400	S7-400 CPUs	•	•	•		•	•	•	• ³⁾	• ³⁾	•	•
	CP 443-5 Extended	•	•		•	•	•	•	•	•		•
SIMATIC S7mEC	CP 5603	•	•	•	•	•	•					

1) 16 DP slaves maximum
 2) 32 DP slaves maximum
 3) special F- or H-CPU

• applies
 ○ with restrictions

G_IK10_XX_50199

Overview of functions for SIMATIC CPs/CMs and CPUs

PROFIBUS

Communication for SIMATIC S7-1200

CM 1242-5

Overview



DP-M	DP-S	FMS	PG/OP	S7
	●			

The CM 1242-5 communication module is used to connect a SIMATIC S7-1200 to PROFIBUS as a DP slave and has the following characteristics:

- PROFIBUS DPV1 slave in accordance with IEC 61158
- Module replacement without PG supported
- Power is supplied via the backplane bus so that no extra cabling is required
- Support of all standard baud rates from 9.6 Kbit/s to 12 Mbit/s
- Compact industry-standard enclosure in S7-1200 design for mounting on a standard mounting rail
- Fast commissioning thanks to easy configuration using STEP 7 without additional programming overhead

The CM 1242-5 is intended for use in factory automation. Low-cost PROFIBUS-based automation solutions can be created on the basis of the S7-1200 for optimal production.

Benefits



PROFIBUS-based systems can be operated effectively for lower operating and maintenance costs:

- Low costs since an automation solution requires no fixed wiring and less hardware
- Fast response to faults thanks to comprehensive diagnostics options
- Optimized plant and inventory management

The CM 1242-5 also offers further benefits especially for the requirements of micro-automation solutions:

- Uncomplicated connection of the S7-1200 to PROFIBUS without extra power supply
- Low-cost implementation of automation solutions based on PROFIBUS
- Fast commissioning, as no programming overhead is required

Application

The CM 1242-5 is designed for use in factory automation.

With the CM 1242-5, low-cost, distributed automation solutions can be implemented on the basis of the S7-1200, or in simple cases even complete plant automation systems. It can be used in all sectors of discrete automation. These include, for example:

- Automotive
- Pharmaceuticals
- Semiconductors
- Food processing industry

Design



The CM 1242-5 offers all the benefits of the S7-1200 design.

- Rugged, compact plastic enclosure
- Easily accessible connection and diagnostics elements, protected by front flaps
- Removable connecting terminals
- Simple mounting on the mounting rail of the S7-1200
- 9-pin sub-D socket for the bus interface to PROFIBUS

The CM 1242-5 is plugged into the left-hand system bus interface of the S7-1200. Power is supplied via the system bus of the S7-1200 so that no extra cabling is required. The rugged RS485 interface is located on the underside of the module, protected by the lower front flap.

3

Function

The CM 1242-5 provides the communication services for integrating an S7-1200 into an automation solution as a PROFIBUS DP slave.

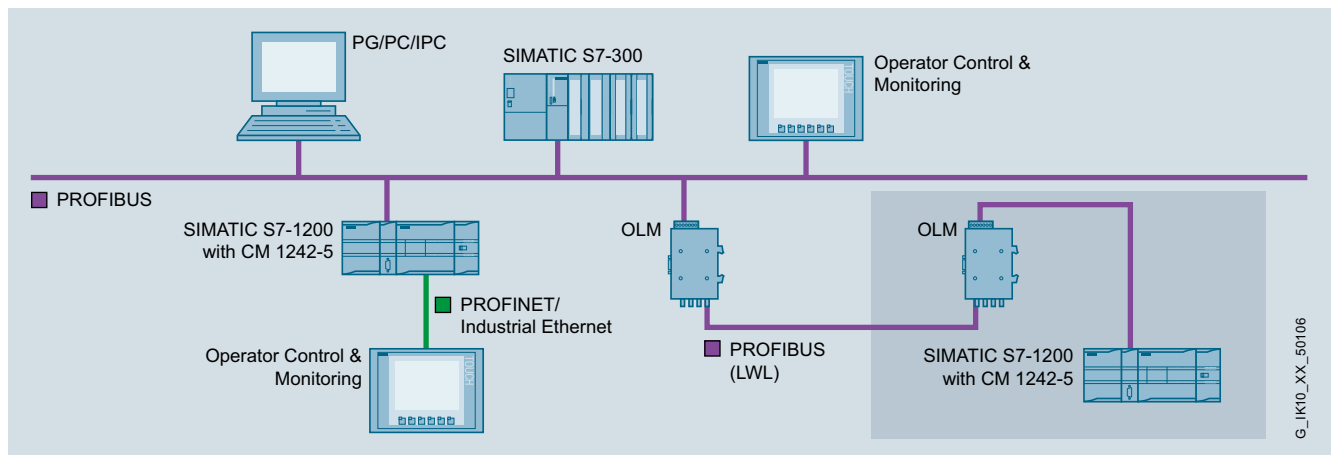

PROFIBUS DP slave

The CM 1242-5 works as a DPV1 slave in accordance with IEC 61158, handles data traffic completely autonomously, and thus relieves the CPU of communication tasks.

The data areas of the distributed I/Os are transferred consistently between CP and CPU.

Diagnosis

Extensive diagnostic options are available via STEP 7, including

- Operating state of the CM
- General diagnostics functions
- Connection diagnostics
- Message buffer

STEP 7 Basic V11 or higher is required for configuring the full functional scope of the CP 1242-5.

PROFIBUS

Communication for SIMATIC S7-1200

CM 1242-5

Technical specifications

Article No.	6GK7242-5DX30-0XE0
Product-type designation	CM 1242-5
Transmission rate	
Transmission rate at interface 1 in accordance with PROFIBUS	9.6 kbit/s ... 12 Mbit/s
Interfaces	
Number of electrical connections	
• at interface 1 in accordance with PROFIBUS	1
• for power supply	0
Design of electrical connection	
• at interface 1 in accordance with PROFIBUS	9-pin Sub-D socket (RS485)
• for power supply	-
Supply voltage, current consumption, power loss	
Type of supply voltage	DC
Supply voltage	
• 1 from backplane bus	5 V
• external	-
Relative positive tolerance at 24 V with DC	-
Relative negative tolerance at 24 V with DC	-
Consumed current	
• from backplane bus at 5 V for DC Typical	0.15 A
• from external supply voltage at 24 V with DC	
- typical	-
- maximum	-
Resistive loss	0.75 W
Permitted ambient conditions	
Ambient temperature	
• for vertical installation during operating phase	0 ... 45 °C
• for horizontal installation during operating phase	0 ... 55 °C
• during storage	-40 ... +70 °C
• during transport	-40 ... +70 °C
• Comment	-
Relative humidity at 25 °C without condensation during operating maximum	95 %
Protection class IP	IP20
Design, dimensions and weight	
Module format	Compact module S7-1200 single width
Width	30 mm
Height	100 mm
Depth	75 mm
Net weight	0.115 kg
Product properties, functions, components general	
Number of modules per CPU maximum	3
Number of modules note	-

Article No.	6GK7242-5DX30-0XE0
Product-type designation	CM 1242-5
Performance data	
<u>Performance data open communication</u>	
Number of possible connections for open communication by means of SEND/RECEIVE blocks maximum	-
Data volume as user data per connection for open communication by means of SEND/RECEIVE blocks maximum	-
<u>Performance data PROFIBUS DP</u>	
Service as DP master DPV1	-
Number of DP slaves on DP master usable	-
Amount of data	
• of the address area of the inputs as DP master overall	-
• of the address area of the outputs as DP master overall	-
• of the address area of the inputs per DP slave	-
• of the address area of the outputs per DP slave	-
• of the address area of the diagnostic data per DP slave	-
Service as DP slave	
• DPV0	Yes
• DPV1	Yes
Amount of data	
• of the address area of the inputs as DP slave overall	240 byte
• of the address area of the outputs as DP slave overall	240 byte
<u>Performance data S7 communication</u>	
Number of possible connections for S7 communication	
• maximum	-
• with PG connections maximum	-
• with PG/OP connections maximum	-
• note	-
<u>Performance data multi-protocol mode</u>	
Number of active connections with multi-protocol mode	
• without DP maximum	-
• with DP maximum	-
Product functions management, configuration	
Configuration software required	STEP 7 Basic/Professional V11 (TIA Portal) or higher

Ordering data	Article No.
CM 1242-5 communication module Communication module for electrical connection of SIMATIC S7-1200 to PROFIBUS as a DPV1 slave	6GK7242-5DX30-0XE0
Accessories	
PROFIBUS FastConnect connection plug RS485 With 90° cable outlet; insulation displacement technology, max. transmission rate 12 Mbit/s <ul style="list-style-type: none"> • Without PG interface • With PG interface 	6ES7972-0BA52-0XA0 6ES7972-0BB52-0XA0
PROFIBUS FC Standard Cable 2-core bus cable, shielded, special design for fast mounting, delivery unit: max. 1 000 m, minimum order 20 m, sold by the meter	6XV1830-0EH10
PROFIBUS FastConnect Stripping Tool Stripping tool for fast stripping of the PROFIBUS FastConnect bus cable	6GK1905-6AA00
PROFIBUS bus terminal 12M Bus terminal for connection of PROFIBUS nodes at up to 12 Mbit/s with connecting cable	6GK1500-0AA10

Note:

For software ordering data, see page 3/178

PROFIBUS

Communication for SIMATIC S7-1200

CM 1243-5

Overview



DP-M	DP-S	FMS	PG/OP	S7
●			●	●

The CM 1243-5 communication module is used to connect a SIMATIC S7-1200 to PROFIBUS as a DP master and has the following characteristics:

- PROFIBUS DPV1 master in accordance with IEC 61158
- Support of up to 16 PROFIBUS DP slaves
- Communication with other S7 controllers based on S7 communication
- Allows the connection of programming devices and operator panels with a PROFIBUS interface to the S7-1200
- Module replacement without PG supported
- Support of all standard baud rates from 9.6 Kbit/s to 12 Mbit/s
- Compact industry-standard enclosure in S7-1200 design for mounting on a standard mounting rail
- Fast commissioning thanks to easy configuration using STEP 7 without additional programming overhead

The CM 1243-5 is intended for use in factory automation. Low-cost PROFIBUS-based automation solutions can be created on the basis of the S7-1200 for optimal production.

Benefits



PROFIBUS-based systems can be operated effectively for lower operating and maintenance costs:

- Low costs since an automation solution requires no fixed wiring and less hardware
- Fast response to faults thanks to excellent diagnostics options
- Optimized plant and inventory management

The CM 1243-5 also offers further benefits especially for the requirements of micro-automation solutions:

- Uncomplicated connection of the S7-1200 to PROFIBUS
- Low-cost implementation of automation solutions based on PROFIBUS
- Fast commissioning, as no programming overhead is required

Use of PROFIBUS-based micro-automation solutions enables optimal operation of the plant and problem-free production.

Application

The CM 1243-5 is designed for use in factory automation, particularly for mechanical engineering

With the CM 1243-5, low-cost, distributed automation solutions can be implemented on the basis of the S7-1200, or in simple cases even complete plant automation systems. It can be used in all sectors of discrete automation. These include, for example:

- Automotive
- Pharmaceuticals
- Semiconductors
- Food processing industry

In mechanical engineering, the S7-1200 can be used with the CM 1243-5 as a central control unit, with sensors, actuators or the HMI devices connected direct via PROFIBUS.

- Pick-and-place machines
- Metalworking machines
- Packaging machinery
- Printing machines
- Textile machines
- Filling machines

Design



The CM 1243-5 offers all the benefits of the S7-1200 design.

- Rugged, compact plastic enclosure
- Easily accessible connection and diagnostics elements, protected by front flaps
- Removable connecting terminals
- Simple mounting on the mounting rail of the S7-1200
- 9-pin sub-D socket for the bus interface to PROFIBUS
- 3-pin plug-in terminal strip for connection of the 24 V DC external supply voltage

The CM 1243-5 is plugged into the left-hand system bus interface of the S7-1200. The power is supplied via a 3-pin terminal strip on top of the module. The rugged RS485 interface is located on the underside of the module, protected by the lower front flap.

3

Function

The CM 1243-5 provides access to different communication services on the basis of PROFIBUS:

- PROFIBUS DP (according to IEC 61158, master)
- PG/OP communication
- S7 communication

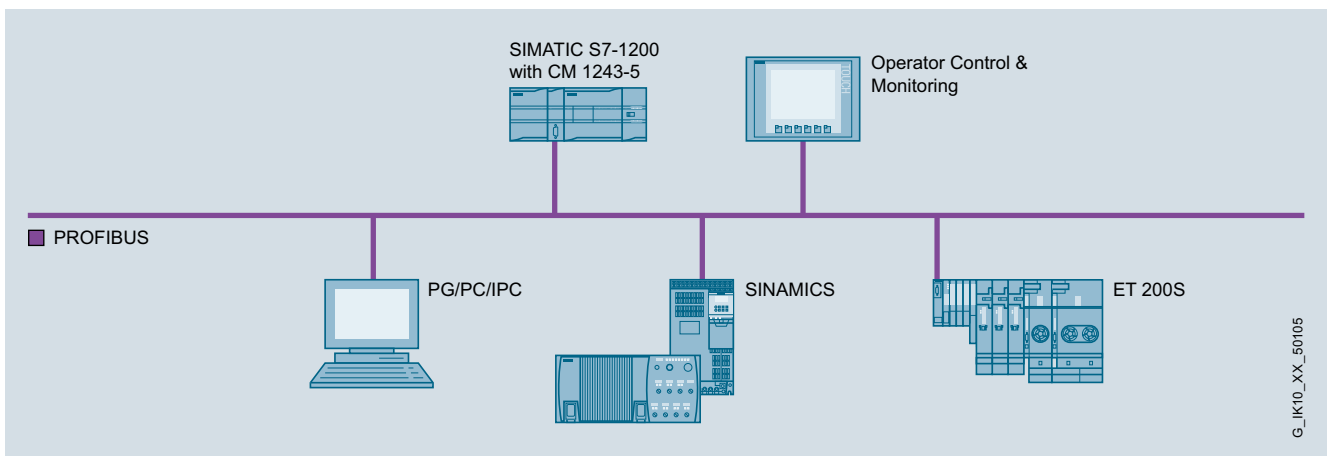

PROFIBUS DP master

The CM 1243-5 works as a DP-V1 master in accordance with IEC 61158, handles data traffic completely autonomously, and thus relieves the CPU of communication tasks.

The data areas of the distributed I/Os are transferred consistently between CP and CPU. As a DP master, it allows the connection of up to 16 PROFIBUS-compliant DP slaves

PG/OP communication

The S7-1200 to which the CM 1243-5 is connected can be programmed with the help of PG/OP communication.

S7 communication

Communication with the following other systems can be implemented with the mechanisms familiar from the S7 world (Put/Get) on the basis of S7 communication:

- To other SIMATIC S7 programmable controllers
- To HMI devices
- To PCs, laptops, field PGs with PROFIBUS cards

Diagnosis

Extensive diagnostic options are available via STEP 7, including

- Operating state of the CM
- General diagnostics and statistics functions
- Connection diagnostics
- Message buffer

STEP 7 Basic V11 or higher is required for configuring the full functional scope of the CP 1243-5.

PROFIBUS

Communication for SIMATIC S7-1200

CM 1243-5

Technical specifications

Article No.	6GK7243-5DX30-0XE0
Product-type designation	CM 1243-5
Transmission rate	
Transmission rate at interface 1 in accordance with PROFIBUS	9.6 kbit/s ... 12 Mbit/s
Interfaces	
Number of electrical connections	
• at interface 1 in accordance with PROFIBUS	1
• for power supply	1
Design of electrical connection	
• at interface 1 in accordance with PROFIBUS	9-pin Sub-D socket (RS485)
• for power supply	3-pin terminal strip
Supply voltage, current consumption, power loss	
Type of supply voltage	DC
Supply voltage	
• 1 from backplane bus	-
• external	24 V
Relative positive tolerance at 24 V with DC	20 %
Relative negative tolerance at 24 V with DC	20 %
Consumed current	
• from backplane bus at 5 V for DC Typical	-
• from external supply voltage at 24 V with DC	
- typical	0.1 A
- maximum	-
Resistive loss	2.4 W
Permitted ambient conditions	
Ambient temperature	
• for vertical installation during operating phase	0 ... 45 °C
• for horizontal installation during operating phase	0 ... 55 °C
• during storage	-40 ... +70 °C
• during transport	-40 ... +70 °C
• Comment	-
Relative humidity at 25 °C without condensation during operating maximum	95 %
Protection class IP	IP20
Design, dimensions and weight	
Module format	Compact module S7-1200 single width
Width	30 mm
Height	100 mm
Depth	75 mm
Net weight	0.134 kg

Article No.	6GK7243-5DX30-0XE0
Product-type designation	CM 1243-5
Product properties, functions, components general	
Number of modules	
• per CPU maximum	1
• note	-
Performance data	
<u>Performance data open communication</u>	
Number of possible connections for open communication by means of SEND/RECEIVE blocks maximum	-
Data volume as user data per connection for open communication by means of SEND/RECEIVE blocks maximum	-
<u>Performance data PROFIBUS DP</u>	
Service as DP master DPV1	Yes
Number of DP slaves on DP master usable	16
Amount of data	
• of the address area of the inputs as DP master overall	512 byte
• of the address area of the outputs as DP master overall	512 byte
• of the address area of the inputs per DP slave	244 byte
• of the address area of the outputs per DP slave	244 byte
• of the address area of the diagnostic data per DP slave	240 byte
Service as DP slave	
• DPV0	No
• DPV1	No
Amount of data	
• of the address area of the inputs as DP slave overall	-
• of the address area of the outputs as DP slave overall	-
<u>Performance data S7 communication</u>	
Number of possible connections for S7 communication	
• maximum	8
• with PG connections maximum	1
• with PG/OP connections maximum	3
• note	max. 4 connections to other S7 stations
<u>Performance data multi-protocol mode</u>	
Number of active connections with multi-protocol mode	
• without DP maximum	8
• with DP maximum	8
Product functions management, configuration	
Configuration software required	STEP 7 Basic/Professional V11 or higher

Ordering data	Article No.
CM 1243-5 communication module Communication module for electrical connection of SIMATIC S7-1200 to PROFIBUS as a DPV1 master	6GK7243-5DX30-0XE0
<i>Accessories</i>	
PROFIBUS FastConnect connection plug RS485 With 90° cable outlet; insulation displacement technology, max. transmission rate 12 Mbit/s <ul style="list-style-type: none"> • Without PG interface • With PG interface 	6ES7972-0BA52-0XA0 6ES7972-0BB52-0XA0
PROFIBUS FC Standard Cable 2-core bus cable, shielded, special design for fast mounting, delivery unit: max. 1 000 m, minimum order 20 m, sold by the meter	6XV1830-0EH10
PROFIBUS FastConnect Stripping Tool Stripping tool for fast stripping of the PROFIBUS FastConnect bus cable	6GK1905-6AA00
PROFIBUS bus terminal 12M Bus terminal for connection of PROFIBUS nodes at up to 12 Mbit/s with connecting cable	6GK1500-0AA10

Note:

For software ordering data, see page 3/178

PROFIBUS

Communication for SIMATIC S7-1500

CM 1542-5

Overview



DP-M	DP-S	FMS	PG/OP	S7	
●	●		●	●	

The CM 1542-5 communication module expands the SIMATIC S7-1500 controller with an additional PROFIBUS connection for communication with lower-level PROFIBUS devices in bandwidths from 9.6 kbps to 12 Mbps. The module also allows the implementation of separate PROFIBUS lines; in other words, the control of multiple field devices via several PROFIBUS segments. The CM 1542-5 assumes all communication tasks, thus reducing the CPU workload.

The CM 1542-5 is suitable for S7 communication as well as for conventional PROFIBUS communication. This makes it possible to establish communication between the S7-1500 controller and other devices, for example those from the SIMATIC S7-300/400 range.

- PROFIBUS DP master or DP slave with electrical interface for connecting the SIMATIC S7-1500 to PROFIBUS at up to 12 Mbit/s (including 45.45 Kbit/s)
- Communication services:
 - PROFIBUS DP
 - PG/OP communication
 - S7 communication
- Time synchronization
- Simple programming and configuration over PROFIBUS
- Cross-network PG communication using S7 routing
- Module replacement without a PG
- Data record routing (PROFIBUS DP)
- Adding or modifying distributed I/O during operation

Benefits

get **Designed for Industry**

- Particularly suitable for closed-loop control tasks thanks to SYNC/FREEZE and constant bus cycle
- Sub-process-oriented design of an automation solution through the use of several CMs
- Universal application of the CM due to the parallel use of different communications services on one CM

Application

The CM 1542-5 is the communications processor of the SIMATIC S7-1500 for the PROFIBUS bus system. It relieves the CPU of communication tasks and supports additional connections.

Communications options of the S7-1500 using communication modules:

- As master for PROFIBUS DP according to IEC 61158/EN 50170
- Communication with programming devices and HMI devices
- Communication with other SIMATIC S7 systems
- Communication with SIMATIC S5 programmable controllers

The number of CMs that can be operated depends on the CPU type and on the communication services used.

Design

The CM 1542-5 communication module features all the advantages of the SIMATIC S7-1500 design:

- Compact design:
 - 9-pin D-sub socket for connection to PROFIBUS DP
 - The module is supplied with power via the integrated backplane bus
 - Three LEDs to indicate the operational and communication status
- Simple installation:
 - The CM 1542-5 is mounted on the rail of the S7-1500 and connected to the other modules of the S7-1500 by means of bus connectors. The slot rules of the S7-1500 system apply.
- User-friendly wiring:
 - the D-sub socket is easily accessible and simple to use.
- The CM 1542-5 can be operated without a fan. A backup battery is not required.
- The module can be replaced without the need for a programming device.

Function

The CM 1542-5 supports the following communication services:

- PROFIBUS DP Master Class 1
 - PROFIBUS DP (according to IEC 61158/61784)
 - SYNC/FREEZE: The outputs and/or inputs can be synchronized from the user program with the DPSYNC_FR system function.
- PROFIBUS DP slave (not when DP master)
- PG/OP communication
- S7 communication
- Time synchronization via PROFIBUS

Master for PROFIBUS DP

The CM 1542-5 operates as DP-V1 master. It handles data transfer independently and allows slaves to be connected, such as the CM 1242-5 as a DP slave, DP slaves of the ET 200 distributed I/O system, etc. This means that the CM 1542-5 is able to connect the S7-1500 station to PROFIBUS DP and is the ideal expansion to the integrated DP master interfaces of the S7-1500 CPUs (CPU 1516 and larger) for establishing additional PROFIBUS DP lines.

The CM 1542-5 is a DP-V1 master; in other words, it also supports the acyclic standard services, including alarm handling. The CM 1542-5 also supports the functions SYNC and FREEZE, constant bus cycle time and data record routing.

During normal operation, it is also possible to activate or deactivate DP slaves. Among other things, this allows the step-by-step commissioning of subprocesses.

A diagnostic repeater allows the line to be diagnosed during operation, enabling line faults to be detected at an early stage. The CM 1542-5 supports operation with a diagnostic repeater (including activation of topology identification on the diagnostic repeater).

The distributed I/O is handled like the central I/O from the user's point of view. This means that there are no differences between the CM 1542-5 and the integrated DP master interface of the S7-1500 CPU in terms of configuration and parameter assignment. Regardless of the scale of the system, the CM 1542-5 has extremely short response times.

PG/OP communication

PG/OP communication allows all S7 stations connected to the network to be remotely programmed.

- S7 routing: With the aid of routing it is possible to use programming device communication across different networks.

S7 communication

S7 communication is used for the coupling

- between SIMATIC S7 automation systems
- and programming devices (PG/OP communication)
- to PCs, e.g. CP 5711 with SOFTNET-PB S7, CP 5623 etc.
- and HMI devices (OPs)

Time synchronization

Time synchronization is used to set the time of day throughout the plant.

The CM 1542-5 is capable of forwarding the time of day of the S7-1500 CPU to PROFIBUS. Conversely, the CM of the S7-1500 CPU can make an existing time on PROFIBUS available.

The CM 1542-5 supports:

- Time status value, daylight-saving time changeover, synchronization status

Data record routing

The CM 1542-5 supports the data record routing function. With this option, the CP can be used as a router for data records that need to be sent to field devices (DP slaves). Data records from devices that are not connected directly to PROFIBUS and therefore have no direct access to the DP slaves are forwarded to the DP slaves by the CM.

Diagnostics

Extensive diagnostic options are available with STEP 7 Professional V13 (TIA Portal), including:

- Operating status of the CM
- General diagnostics and statistics functions
- Connection diagnostics
- Bus statistics
- Alarm buffer
- Support of operation with diagnostic repeater

PROFIBUS

Communication for SIMATIC S7-1500

CM 1542-5

Design (continued)

Configuration

STEP 7 Professional V12 (TIA Portal) or higher is required for configuring the full range of functions of the CM 1542-5. The configuration data of the CM is always saved on the CPU and retained even after a PLC failure. It is therefore possible to replace a module without having to reload the configuration data from a programming device. The CPU transfers the configuration data to the CM during startup.

Configuration and programming of all SIMATIC S7 controllers connected to the network is possible over the network.

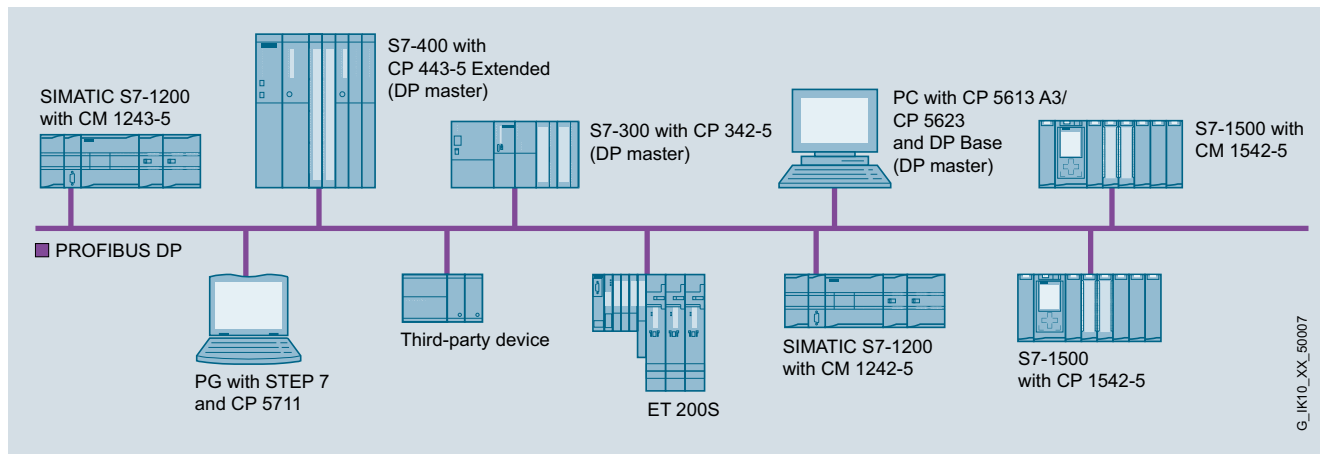

Technical specifications

Article No.	6GK7542-5DX00-0XE0
Product-type designation	CM 1542-5
Transmission rate	
Transmission rate at interface 1 • in accordance with PROFIBUS	9.6 kbit/s ... 12 Mbit/s
Interfaces	
Number of electrical connections at interface 1 • in accordance with PROFIBUS	1
Design of electrical connection at interface 1 • in accordance with PROFIBUS	9-pin Sub-D socket (RS485)
Supply voltage, current consumption, power loss	
Type of supply voltage	DC
Supply voltage 1 • from backplane bus	15 V
Relative symmetrical tolerance at 15 V with DC	3 %
Current consumption from backplane bus at 15 V with DC typical	0.2 A
Resistive loss	3 W
Permitted ambient conditions	
Ambient temperature • for vertical installation during operating phase	0 ... 40 °C
• for horizontal installation during operating phase	0 ... 60 °C
• during storage	-40 ... +70 °C
• during transport	-40 ... +70 °C
• Comment	-
Relative humidity at 25 °C without condensation during operating maximum	95 %
Protection class IP	IP20
Design, dimensions and weight	
Module format	Compact module S7-1500 single width
Width	35 mm
Height	142 mm
Depth	129 mm
Net weight	0.4 kg
Mounting type S7-1500 rail mounting	Yes

Article No.	6GK7542-5DX00-0XE0
Product-type designation	CM 1542-5
Product properties, functions, components general	
Number of modules • per CPU maximum • note	8 depending on CPU type
Performance data	
<u>Performance data PROFIBUS DP</u>	
Service as DP master DPV1	Yes
Number of DP slaves on DP master usable	125
Amount of data	
• of the address area of the inputs as DP master overall	8 192 byte
• of the address area of the outputs as DP master overall	8 192 byte
• of the address area of the inputs per DP slave	244 byte
• of the address area of the outputs per DP slave	244 byte
• of the address area of the diagnostic data per DP slave	-
Service as DP slave	
• DPV0	Yes
• DPV1	Yes
Amount of data	
• of the address area of the inputs as DP slave overall	240 byte
• of the address area of the outputs as DP slave overall	240 byte
<u>Performance data S7 communication</u>	
Number of possible connections for S7 communication	
• maximum	40
• with PG connections maximum	-
• with PG/OP connections maximum	-
• note	depending on the system upper limit
<u>Performance data multi-protocol mode</u>	
Number of active connections with multi-protocol mode	40
Product functions management, configuration	
Configuration software required	STEP 7 Professional V12 (TIA Portal) or higher
Product functions Diagnosis	
Product function Web-based diagnostics • note	Yes Yes, via S7-1500 CPU
Product functions Time	
Product function pass on time synchronization	Yes

PROFIBUS

Communication for SIMATIC S7-1500

CM 1542-5

Ordering data**Article No.****CM 1542-5 communication module**

Communication module for electrical connection of SIMATIC S7-1500 to PROFIBUS as a DP master or DP slave

6GK7542-5DX00-0XE0**Accessories****PROFIBUS FastConnect connector RS485**

With 90° cable outlet; insulation displacement technology, max. transmission rate 12 Mbps

- Without PG interface
- with PG interface

6ES7972-0BA52-0XA0
6ES7972-0BB52-0XA0

PROFIBUS FC Standard Cable

2-core bus cable, shielded, special design for fast mounting, delivery unit: max. 1 000 m, minimum order 20 m, sold by the meter

6XV1830-0EH10**PROFIBUS FastConnect Stripping Tool**

Stripping tool for fast stripping of the PROFIBUS FastConnect bus cable

6GK1905-6AA00**PROFIBUS bus terminal 12M**

Bus terminal for connection of PROFIBUS nodes up to 12 Mbps with plug-in cable

6GK1500-0AA10**More information**

You can find more information on SIMATIC S7-1500 at www.siemens.com/simatic-S7-1500

3

Note:

For software ordering data, see page 3/178

Overview



DP-M	DP-S	FMS	PG/OP	S7/S5	
●	●		●		

The CP 1542-5 communications processor expands the SIMATIC S7-1500 controller with an additional PROFIBUS connection for communication with lower-level PROFIBUS devices in bandwidths from 9.6 kbps to 12 Mbit/s. The processor also allows the implementation of separate PROFIBUS lines; in other words, the control of multiple field devices via several PROFIBUS segments. The CP 1542-5 handles all communication tasks, thus reducing the CPU load.

- PROFIBUS DP master or DP slave with electrical interface for connecting the SIMATIC S7-1500 to PROFIBUS at up to 12 Mbit/s (including 45.45 Kbit/s)

Communication services:

- PROFIBUS DP
- PG/OP communication
- Time synchronization
- Simple programming and configuration over PROFIBUS
- Cross-network PG communication using S7 routing
- Module replacement without a PG

Benefits

get **Designed for Industry**

- Particularly suitable for closed-loop control tasks thanks to SYNC/FREEZE and constant bus cycle
- Sub-process-oriented design of an automation solution through the use of several CPs
- Universal application of the CP due to the parallel use of different communication services on one CP

PROFIBUS DP configuration for SIMATIC S5/S7 and PG/PC

Application

The CP 1542-5 is the communications processor of the SIMATIC S7-1500 for the PROFIBUS bus system. It relieves the CPU from communications tasks.

Communications options of the S7-1500 using communication modules:

- As master for PROFIBUS DP according to IEC 61158/EN 50170 (max. 32 DP slaves)
- Communication with programming devices and HMI devices

The number of CPs that can be operated depends on the CPU type and on the communication services used.

Design

The communications processor CP 1542-5 features all the advantages of the SIMATIC S7-1500 design:

- Compact design:
 - 9-pin D-sub socket for connection to PROFIBUS DP
 - The module is supplied with power via the integrated backplane bus
 - Three LEDs to indicate the operational and communication status
- Simple installation:
 - The CP 1542-5 is mounted on the rail of the S7-1500 and connected to the other modules of the S7-1500 by means of the bus connectors. The slot rules of the S7-1500 system apply.
- User-friendly wiring:
 - the D-sub socket is easily accessible and simple to use.
- The CP 1542-5 can be operated without a fan. A backup battery is not required.
- The module can be replaced without the need for a programming device.

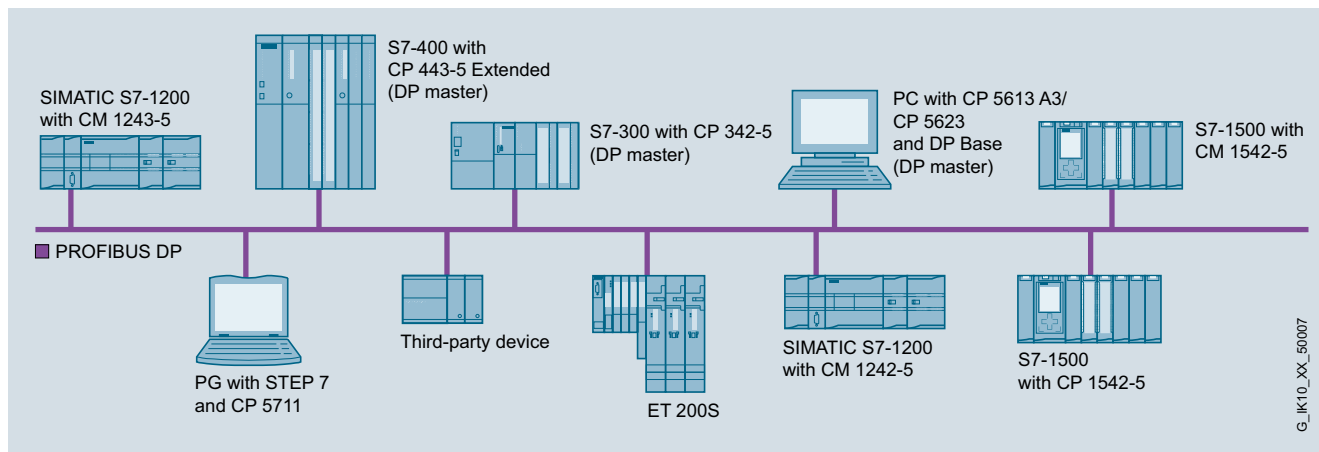

PROFIBUS

Communication for SIMATIC S7-1500

CP 1542-5

Function

The CP 1542-5 supports the following communications services:

- PROFIBUS DP Master Class 1
 - PROFIBUS DP (according to IEC 61158/61784)
 - SYNC/FREEZE: The outputs or inputs can be synchronized from the user program with the DPSYNC_FR system function.
- PROFIBUS DP slave (not when DP master)
- PG/OP communication
- Time synchronization via PROFIBUS

Master for PROFIBUS DP

The CP 1542-5 operates as DP-V1 master. It handles data transfer independently and allows up to 32 slaves to be connected, such as the CM 1242-5 as a DP slave, DP slaves of the ET 200 distributed I/O system, etc. This means that the CP 1542-5 is able to connect the S7-1500 station to PROFIBUS DP and is the ideal expansion to the integrated DP master interfaces of the S7-1500 CPUs (CPU 1516 and larger) for establishing additional PROFIBUS DP lines.

The CP 1542-5 is a DP-V1 master; in other words, it also supports the acyclic standard services, including alarm handling. The CP 1542-5 also supports the functions SYNC, FREEZE, and constant bus cycle time.

During normal operation, it is also possible to activate or deactivate DP slaves. Among other things, this allows the step-by-step commissioning of subprocesses.

A diagnostic repeater allows the line to be diagnosed during operation, enabling line faults to be detected at an early stage. The CP 1542-5 supports operation with a diagnostic repeater (including activation of topology identification on the diagnostic repeater).

There are no differences between the CP 1542-5 and the integral DP master interface of the S7-1500 CPU with regard to configuration and programming. The distributed I/O is therefore handled like the central I/O just as for the CPU. Regardless of the scale of the system, the CP 1542-5 has extremely short response times.

PG/OP communication

PG/OP communication allows all S7 stations connected to the network to be remotely programmed.

- S7 routing: With the aid of routing it is possible to use programming device communication across different networks.

S7 communication

S7 communication is used for coupling to the following devices:

- Programming devices (PG/OP communication)
- HMI devices (OP)

Time synchronization

Time synchronization is used to set the time of day throughout the plant.

The CP 1542-5 is capable of forwarding the time of day of the S7-1500 CPU to PROFIBUS. Conversely, the CP of the S7-1500 CPU can make an existing time of day available on PROFIBUS.

The CP 1542-5 supports:

- Time status value, daylight-saving time changeover, synchronization status

Diagnostics

Extensive diagnostics options are available with STEP 7 Professional of the TIA Portal V12 SP1 or higher, including:

- Status of the CP
- General diagnostics and statistics functions
- Connection diagnostics
- Bus statistics
- Alarm buffer
- Support of operation with diagnostic repeater

Configuration

STEP 7 Professional of the TIA Portal V12 SP1 or higher is required for configuring the full range of functions of the CP 1542-5. The configuring data of the CP are always saved on the CPU and are retained even after a PLC failure. A module can therefore be replaced without having to reload the configuration data from a programming device. The CPU transfers the configuration data to the CP during start-up.

Configuration and programming of all SIMATIC S7 controllers connected to the network is possible over the network.

Technical specifications

Article No.	6GK7542-5FX00-0XE0	Article No.	6GK7542-5FX00-0XE0
Product-type designation	CP 1542-5	Product-type designation	CP 1542-5
Transmission rate		Product properties, functions, components general	
Transmission rate at interface 1 • in accordance with PROFIBUS	9.6 kbit/s ... 12 Mbit/s	Number of modules • per CPU maximum • note	8 depending on CPU type
Interfaces		Performance data	
Number of electrical connections at interface 1 • in accordance with PROFIBUS	1	Performance data <u>PROFIBUS DP</u>	
Design of electrical connection at interface 1 • in accordance with PROFIBUS	9-pin Sub-D socket (RS485)	Service as DP master DPV1	Yes
Supply voltage, current consumption, power loss		Number of DP slaves on DP master usable	32
Type of supply voltage	DC	Amount of data	
Supply voltage 1 • from backplane bus	15 V	• of the address area of the inputs as DP master overall	2 048 byte
Relative symmetrical tolerance at 15 V with DC	3 %	• of the address area of the outputs as DP master overall	2 048 byte
Current consumption from backplane bus at 15 V with DC typical	0.1 A	• of the address area of the inputs per DP slave	244 byte
Resistive loss	1.5 W	• of the address area of the outputs per DP slave	244 byte
Permitted ambient conditions		• of the address area of the diagnostic data per DP slave	-
Ambient temperature		Service as DP slave	
• for vertical installation during operating phase	0 ... 40 °C	• DPV0	Yes
• for horizontal installation during operating phase	0 ... 60 °C	• DPV1	Yes
• during storage	-40 ... +70 °C	Amount of data	
• during transport	-40 ... +70 °C	• of the address area of the inputs as DP slave overall	240 byte
• Comment	-	• of the address area of the outputs as DP slave overall	240 byte
Relative humidity at 25 °C without condensation during operating maximum	95 %	Performance data <u>S7 communication</u>	
Protection class IP	IP20	Number of possible connections for S7 communication	
Design, dimensions and weight		• maximum	16
Module format	Compact module S7-1500 single width	• with PG connections maximum	-
Width	35 mm	• with PG/OP connections maximum	-
Height	142 mm	• note	depending on the system upper limit
Depth	129 mm	Product functions management, configuration	
Net weight	0.27 kg	Configuration software required	STEP 7 Professional V12 SP1 (TIA Portal) or higher
Mounting type S7-1500 rail mounting	Yes	Product functions Diagnosis	
		Product function	Yes
		• note	yes, via S7-1500 CPU
		Product functions Time	
		Product function pass on time synchronization	Yes

PROFIBUS

Communication for SIMATIC S7-1500

CP 1542-5

Ordering data**Article No.****CP 1542-5 communications processor**

Communication module for electrical connection of SIMATIC S7-1500 to PROFIBUS as DP master or DP slave; PG/OP communication, time synchronization, diagnostics

6GK7542-5FX00-0XE0**Accessories****PROFIBUS FastConnect connection plug RS485**

With 90° cable outlet; insulation displacement technology, max. transmission rate 12 Mbit/s

- without programming device interface
- with programming device interface

6ES7972-0BA52-0XA0**6ES7972-0BB52-0XA0****PROFIBUS FC Standard Cable**

2-core bus cable, shielded, special design for fast mounting, delivery unit: max. 1 000 m, minimum order 20 m, sold by the meter

6XV1830-0EH10**PROFIBUS FastConnect Stripping Tool**

Stripping tool for fast stripping of the PROFIBUS FastConnect bus cable

6GK1905-6AA00**PROFIBUS bus terminal 12M**

Bus terminal for connection of PROFIBUS stations for up to 12 Mbit/s with plug-in cable

6GK1500-0AA10Note:

For software ordering data, see page 3/178

More information

You will find more information on SIMATIC S7-1500 at www.siemens.com/simatic-S7-1500

Overview



DP-M	DP-S	FMS	PG/OP	S7/S5	
●	●		●	●	

- PROFIBUS DP master or slave with electrical interface for connecting the SIMATIC S7-300 to PROFIBUS at up to 12 Mbit/s (including 45.45 Kbit/s)
- Communication services:
 - PROFIBUS DP
 - PG/OP communication (OP multiplexing)
 - S7 communication (client, server)
 - Open communication (SEND/RECEIVE)
- Easy configuration and programming over PROFIBUS
- Cross-network programming device communication through S7 routing
- Modules can be replaced without the need for a PG

Benefits



- Expansion of the process I/O to SIMATIC S7-300 with several PROFIBUS DP interfaces
- Flexible use of the process I/O by means of dynamic activation of DP slaves
- Sub-process-oriented design of an automation solution through the use of several CPs
- Optimization of applications and a host of possible uses thanks to active transmission of data with S7 communication
- Extensive operator control and monitoring thanks to multiplex function with OP communication
- Suitable for closed-loop control tasks due to SYNC/FREEZE

Application

The CP 342-5 is the communications processor of the SIMATIC S7-300 for the PROFIBUS DP bus system.

The CP 342-5 relieves the CPU from communication tasks.

Communication possibilities of the S7-300 using communication modules:

- As DP master or slave for PROFIBUS DP V0 according to IEC 61158/EN 50170
- Communication with programming devices and HMI devices
- Communication with other SIMATIC S7 systems
- Communication with SIMATIC S5 programmable controllers

The number of CPs that can be used is dependent on the performance range of the CPU and on the communications services used.

Design

The CP 342-5 offers all the advantages of SIMATIC S7-300 system design:

- Compact design; single standard width of the SM modules of the SIMATIC S7-300
- 9-pin Sub-D socket for connection to PROFIBUS
- 4-pin terminal block for connecting the external supply voltage of 24 V DC
- Simple assembly; The CP 342-5 is mounted on the S7-300 DIN rail and connected to adjacent modules by means of the bus connectors. Slots 4 to 11 in subracks 0 to 3 (coupled through the IM 360/361) can be used for the CP 342-5
- In combination with IM 360/361, the CP 342-5 can also be used in an expansion rack (ER)
- User-friendly wiring; Sub-D socket and the terminal block are easily accessible.
- The CP 342-5 can be operated without a fan; a back-up battery or a memory module is not required

PROFIBUS

Communication for SIMATIC S7-300

CP 342-5

Function

The CP 342-5 provides access to different communication services of the PROFIBUS bus system:

- PROFIBUS DP (according to IEC 61158/61784, master or slave)
- PG/OP communication
- S7 communication (client, server)
- Open communication (SEND/RECEIVE)

PROFIBUS DP master

The CP 342-5 operates as a DP-V0 Master according to IEC 61158/EN 61784 Volume 2 and processes the data transfer completely independently. It supports the services of the Master Classes 1 and 2.

The data areas of the distributed I/Os are transferred consistently between CP and CPU. This applies to the use of the CP as DP Master and as DP Slave. As DP Master, it permits connections to:

- SIMATIC S7-300, such as CP 342-5 as DP slave
- DP slaves of the distributed I/O system ET 200 (integrate as DP-V0 slave)
- PCs, e.g. with CP 5512, CP 5621, CP 5614 A3 and SOFTNET-PB DP

The CP 342-5 also offers the SYNC/FREEZE and shared input/output functions, as well as the activation/deactivation of DP slaves.

PROFIBUS DP slave

The CP 342-5 as a DP-V0 slave permits the SIMATIC S7-300 to exchange data with other PROFIBUS DP masters, which allows a hybrid setup between SIMATIC S5/S7, PCs, ET 200 and other field devices to PROFIBUS DP. Function calls are required for the DP communication. These (DP-SEND/DP-RECV) must be integrated in the STEP 7 user program.

PG/OP communication

PG/OP communication allows all S7 stations connected to the network to be remotely programmed.

- S7 routing
With the aid of S7 routing it is possible to use programming device communication across networks.
Via the CP 342-5 as many as 16 TD/OPs can be merged into one S7-300 station. This requires only one connection resource in the S7-CPU (multiplex channel). The multiplex channel supports the acyclic HMI services.

S7 communication

S7 communication is used for the coupling:

- between SIMATIC S7 automation systems
- to HMI devices (OPs).
- to PCs, e.g. CP 5711 with SOFTNET-PB S7, CP 5623 etc.

Communication with PG and OP takes place without further configuration. In addition, the central controller can also be programmed and configured on a distributed basis via the CP 342-5.

The client functionality is provided by means of loadable communication blocks.

Open communication (SEND/RECEIVE)

Based on Layer 2 (FDL) of PROFIBUS, the CP 342-5 offers a simple, optimized interface for process or field communication.

This interface offers integrated, high-performance communication between SIMATIC S5, SIMATIC S7, SIMATIC 505 and PC. SEND/RECEIVE provides not only the SDA service (PLC/PLC connections) but also the SDN service (broadcast, multicast).

The communication partners are the automation systems:

- SIMATIC S7
with CP 342-5, CP 343-5, CP 443-5 Extended and Basic
- SIMATIC S5
with S5-95U with PROFIBUS interface, S5-115U/H, S5-135U, S5-155U/H with CP 5431 FMS/DP
- SIMATIC 505
with CP 5434-FMS
- PCs
with CP 5512, CP 5611 A2, CP 5621, CP 5613 A3, CP 5613 FO, CP 5614 A3, CP 5623, CP 5624
- Systems of other makes that are equipped with an FDL interface.

To use SEND/RECEIVE, function calls are required (PLC-SEND/PLC-RECEIVE), which must be linked into the STEP 7 user program.

Diagnostics

Extensive diagnostic options are available via STEP 7, including:

- Status of the CP
- General diagnostics and statistics functions
- Connection diagnostics
- Bus statistics
- Message buffer

STEP 7 V5.5 SP2 or higher, or STEP 7 Professional V11 or higher, is required for configuring the full functional scope of the CP 342-5. In Version V5 or higher of STEP 7, the configuration data of the CP can also optionally be stored on the CPU and is retained even if there is a power failure. A module can therefore be replaced without having to reload the configuration data from a programming device. The CPU transfers the configuration data to the CP during start-up. Attention should therefore be paid to the memory capacity of the S7-CPU.

Configuration and programming of all SIMATIC S7 controllers connected to the network is possible over the network.

The function blocks for PROFIBUS DP are included in the standard library of STEP 7. The function blocks for using the open communication (SEND/RECEIVE) and S7 communication (S7 client) can be found in the SIMATIC NET library following installation of STEP 7.

Technical specifications

Article No.	6GK7342-5DA03-0XE0
Product-type designation	CP 342-5
Transmission rate	
Transmission rate at interface 1 in accordance with PROFIBUS	9.6 kbit/s ... 12 Mbit/s
Interfaces	
Number of electrical connections	
• at interface 1 in accordance with PROFIBUS	1
• for power supply	1
Design of electrical connection	
• at interface 1 in accordance with PROFIBUS	9-pin Sub-D socket (RS485)
• for power supply	4-pin terminal strip
Supply voltage, current consumption, power loss	
Type of supply voltage	DC
Supply voltage	
• 1 from backplane bus	5 V
• external	24 V
Relative positive tolerance at 24 V with DC	20 %
Relative negative tolerance at 24 V with DC	15 %
Consumed current	
• from backplane bus at 5 V for DC Typical	0.15 A
• from external supply voltage at 24 V with DC	
- typical	0.25 A
- maximum	-
Resistive loss	6.75 W
Permitted ambient conditions	
Ambient temperature	
• during operating	0 ... 60 °C
• during storage	-40 ... +70 °C
• during transport	-40 ... +70 °C
• Comment	-
Relative humidity at 25 °C without condensation during operating maximum	95 %
Protection class IP	IP20
Design, dimensions and weight	
Module format	Compact module S7-300 single width
Width	40 mm
Height	125 mm
Depth	120 mm
Net weight	0.3 kg

Article No.	6GK7342-5DA03-0XE0
Product-type designation	CP 342-5
Product properties, functions, components general	
Number of modules	
• per CPU maximum	4
• note	-
Performance data	
<u>Performance data open communication</u>	
Number of possible connections for open communication by means of SEND/RECEIVE blocks maximum	16
Data volume as user data per connection for open communication by means of SEND/RECEIVE blocks maximum	240 byte
<u>Performance data PROFIBUS DP</u>	
Service as DP master DPV0	Yes
Number of DP slaves on DP master usable	124
Amount of data	
• of the address area of the inputs as DP master overall	2 160 byte
• of the address area of the outputs as DP master overall	2 160 byte
• of the address area of the inputs per DP slave	244 byte
• of the address area of the outputs per DP slave	244 byte
• of the address area of the diagnostic data per DP slave	240 byte
Service as DP slave	
• DPV0	Yes
• DPV1	-
Amount of data	
• of the address area of the inputs as DP slave overall	240 byte
• of the address area of the outputs as DP slave overall	240 byte
<u>Performance data S7 communication</u>	
Number of possible connections for S7 communication	
• maximum	16
• with PG connections maximum	-
• with PG/OP connections maximum	-
• note	-
<u>Performance data multi-protocol mode</u>	
Number of active connections with multi-protocol mode	
• without DP maximum	32
• with DP maximum	28
Product functions management, configuration	
Configuration software required	STEP 7 V5.1 SP2 or higher/ STEP 7 Professional V12 (TIA Portal) or higher

PROFIBUS

Communication for SIMATIC S7-300

CP 342-5

Ordering data**Article No.****CP 342-5 communications processor**

Communications processor for electrical connection of SIMATIC S7-300 to PROFIBUS at up to 12 Mbit/s, with electronic manual on CD-ROM

6GK7342-5DA03-0XE0**Accessories****PROFIBUS FastConnect connection plug RS485**

With 90° cable outlet; insulation displacement technology, max. transmission rate 12 Mbit/s

- Without PG interface
- With PG interface

6ES7972-0BA52-0XA0
6ES7972-0BB52-0XA0

PROFIBUS bus connector IP20

With connection to PPI, MPI, PROFIBUS

- Without PG interface
- With PG interface

6ES7972-0BA12-0XA0
6ES7972-0BB12-0XA0

PROFIBUS FC Standard Cable

2-core bus cable, shielded, special design for fast mounting, delivery unit: max. 1 000 m, minimum order 20 m, sold by the meter

6XV1830-0EH10**PROFIBUS bus terminal 12M**

Bus terminal for connection of PROFIBUS nodes at up to 12 Mbit/s with connecting cable

6GK1500-0AA10**SIMATIC S7-300 DM 370**

Dummy module; used for module replacement

6ES7370-0AA01-0AA0Note:

For software ordering data, see page 3/178

Overview



DP-M	DP-S	FMS	PG/OP	S7/S5	
●	●		●	●	

- PROFIBUS DP master or slave with optical interface for connecting the SIMATIC S7-300 to PROFIBUS at up to 12 Mbit/s (including 45.45 Kbit/s)
- Direct connection to the optical PROFIBUS network over the integrated fiber-optic interface for plastic and PCF fiber-optic cables
- Communication services:
 - PROFIBUS DP
 - PG/OP communication (OP multiplexing)
 - S7 communication (client, server)
 - Open communication (SEND/RECEIVE)
- Easy configuration and programming over PROFIBUS
- Cross-network programming device communication through S7 routing
- Modules can be replaced without the need for a PG

Benefits



- The fiber-optic technology is used when
 - the environment is subject to strong EMC interference,
 - strong potential differences exist and
 - high transmission rates are required.
- The CP 342-5 FO is connected directly to the optical PROFIBUS and is therefore specially suited to harsh industrial environments
- Expansion of the process I/O at SIMATIC S7-300 by several PROFIBUS DP interfaces
- Optimization of applications and many application options through sending of data with S7 communication
- Comprehensive control and monitoring through multiplex function with OP communication
- Suitable for closed loop control tasks due to SYNC and FREEZE.

Application

The CP 342-5 FO is the communications processor of the SIMATIC S7-300 for the PROFIBUS DP optical bus system.

The CP 342-5 FO has a fiber optic interface that facilitates interference-immune connections even in environments with severe levels of radio interference.

It relieves the CPU of communications tasks.

Communication of the SIMATIC S7-300 with:

- the distributed I/O system ET 200 with integral optical interface
- SIMATIC S7-400 with IM 467 FO and CP 342-5 FO
- PC with CP 5613 FO
- Remaining PROFIBUS nodes via the optical bus terminal (OBT)

The number of CPs that can be used is dependent on the performance range of the CPU and on the communications services used.

Design

The CP 342-5 FO offers all the advantages of SIMATIC S7-300 system design:

- Compact design; single standard width of the SM modules of the SIMATIC S7-300
- Integrated fiber-optic cable interface; 2 female duplex connectors for direct connection to the optical PROFIBUS over 2 x 2 male simplex connectors and 2 plug-in adapters
- 4-pin terminal block for connecting the external supply voltage of 24 V DC
- Easy installation; the CP 342-5 FO is snap-mounted on the S7-300 DIN rail and connected to adjacent modules through the bus connectors. There are no slot rules.
- In combination with IM 360/361, the CP 342-5 FO can also be used in an expansion rack (ER).
- User-friendly wiring; female FOC connector and the terminal block are easily accessible.
- The CP 342-5 FO can be operated without a fan; a back-up battery or a memory module are not required.

PROFIBUS

Communication for SIMATIC S7-300

CP 342-5 FO

Function

The CP 342-5 FO provides access to different communication services of the PROFIBUS bus system:

- PROFIBUS DP (according to IEC 61 158/61784, master or slave)
- PG/OP communication
- S7 communication
- Open communication (SEND/RECEIVE)

PROFIBUS DP master

The CP 342-5 FO operates as a DP-V0 Master according to IEC 61 158/EN 50 170 Volume 2 and processes the data transfer completely independently. It supports the services of the Master Classes 1 and 2.

The data areas of the distributed I/Os are transferred consistently between CP and CPU. This applies to the use of the CP as DP Master and as DP Slave. As DP Master, it permits connections to:

- The distributed IO system ET 200 with integral optical interface (incorporate as DP-V0 Slave)
- SIMATIC S7-300 with CP 342-5 FO as slave
- The remaining DP-V0 slaves via the optical bus terminal (OBT).

The CP 342-5 FO also offers the SYNC, FREEZE and shared input/output functions, as well as the activation/deactivation of slaves.

PROFIBUS DP slave

The CP 342-5 FO as a DP-V0 Slave allows the SIMATIC S7-300 to exchange data with the SIMATIC S7-400 and with other PROFIBUS DP masters via the OBT, which allows a hybrid setup between SIMATIC S5/S7, PCs, ET 200 and other field devices to PROFIBUS DP. Function calls are required for DP communication, both as master and as slave. These (DP-SEND/DP-RECV) are shipped with STEP 7 and must be integrated in the user program.

PG/OP communication

PG/OP communication allows all S7 stations connected to the network to be remotely programmed.

- S7 routing:
With the aid of S7 routing it is possible to use programming device communication across networks.
Via the CP 342-5 FO as many as 16 TD/OPs can be merged into one S7-300 station. This requires only one connection resource in the S7-CPU (multiplex channel). The multiplex channel supports the acyclic HMI services.

S7 communication

S7 communication is used for the coupling

- between SIMATIC S7 automation systems
- to HMI devices (OPs).
- to PCs, e.g. CP 5711 with SOFTNET-PB S7, CP 5623 etc.

Communication with PG and OP takes place without further configuration. In addition, the central controller can also be programmed and configured on a distributed basis via the CP 342-5 FO.

The client functionality is provided by means of loadable communication blocks.

Open communication (SEND/RECEIVE)

Based on Layer 2 (FDL) of PROFIBUS (IEC 61158/EN 50170), the CP 342-5 FO offers a simple, optimized interface for process or field communication. This interface offers integrated, high-performance communication between SIMATIC S5, SIMATIC S7, SIMATIC 505 and PC.

SEND/RECEIVE provides not only the SDA service (PLC/PLC connections) but also the SDN service (broadcast, multicast).

The communication partners are the automation systems:

- SIMATIC S7 with CP 342-5, CP 343-5, CP 443-5 Extended and Basic
- SIMATIC S5 with S5-95U with PROFIBUS interface, S5-115U/H, S5-135U, S5-155U/H with CP 5431 FMS/DP
- SIMATIC 505 with CP 5434-FMS
- PCs CP 5512, CP 5611 A2, CP 5621, CP 5613 A3, CP 5613 FO, CP 5614 A3, CP 5623, CP 5624
- Systems of other makes that are equipped with an FDL interface.

To use SEND/RECEIVE, function calls are required (PLC-SEND/PLC-RECEIVE), which must be linked into the STEP 7 user program.

Diagnostics

Extensive diagnostic options are available via STEP 7, including:

- Status of the CP
- General diagnostics and statistics functions
- Connection diagnostics
- Bus statistics
- Message buffer

STEP 7 V5.1 SP2 or higher, or STEP 7 Professional V12 (TIA Portal) or higher, is required for configuring the full functional scope of the CP 342-5 FO. In Version V5 or higher of STEP 7, the configuration data of the CP can also optionally be stored on the CPU and is retained even if there is a power failure. A module can therefore be replaced without having to reload the configuration data from a programming device. The CPU transfers the configuration data to the CP during start-up. Attention should therefore be paid to the memory capacity of the S7-CPU.

Configuration and programming of all SIMATIC S7 controllers connected to the network is possible over the network.

The function blocks for PROFIBUS DP are included in the standard library of STEP 7. The function blocks for using the open communication (SEND/RECEIVE) and the S7 communication (S7 client) can be found in the SIMATIC NET library following installation of STEP 7.

Function (continued)

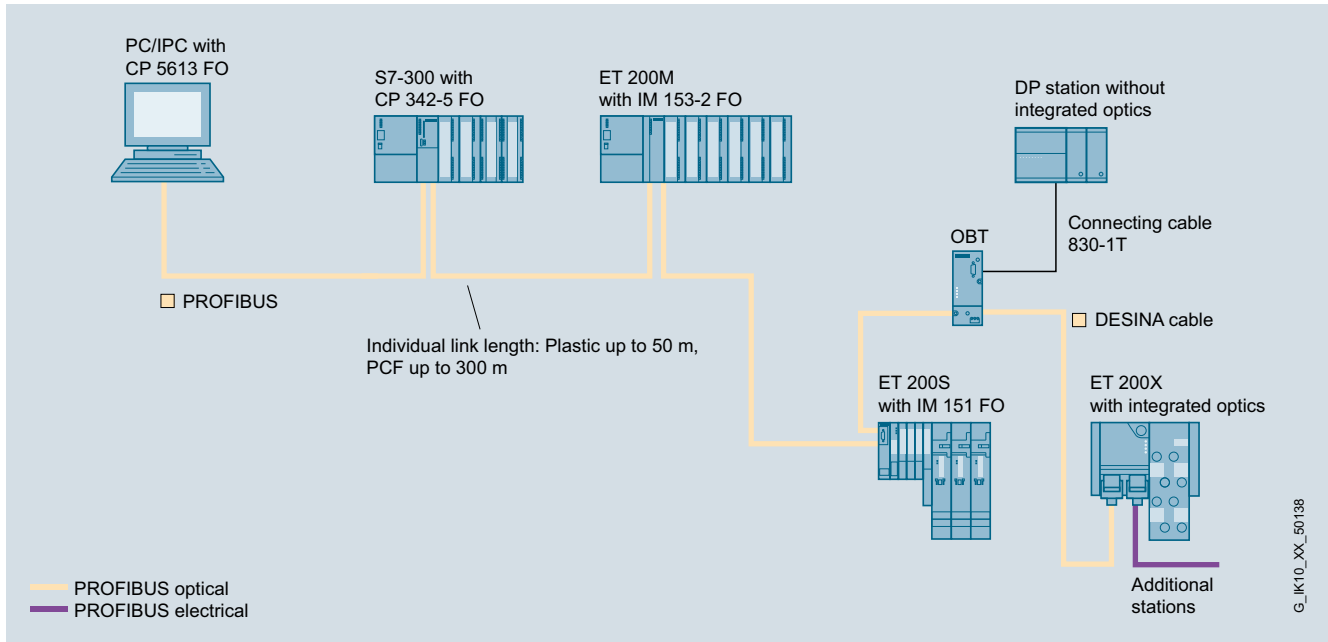

System configuration of optical PROFIBUS DP with CP 342-5 FO

Technical specifications

Article No.	6GK7342-5DF00-0XE0	Article No.	6GK7342-5DF00-0XE0
Product-type designation	CP 342-5 FO	Product-type designation	CP 342-5 FO
Transmission rate		Permitted ambient conditions	
Transmission rate at interface 1 in accordance with PROFIBUS	9.6 kbit/s ... 12 Mbit/s	Ambient temperature	
Interfaces		• during operating	0 ... 60 °C
Number of optical connections at interface 1 in accordance with PROFIBUS	2	• during storage	-40 ... +70 °C
Number of electrical connections for power supply	1	• during transport	-40 ... +70 °C
Design of optical connection at interface 1 in accordance with PROFIBUS	Duplex socket	• Comment	-
Design of the electrical connection for power supply	4-pin terminal strip	Relative humidity at 25 °C without condensation during operating maximum	95 %
Supply voltage, current consumption, power loss		Protection class IP	IP20
Type of supply voltage	DC	Design, dimensions and weight	
Supply voltage		Module format	Compact module
• 1 from backplane bus	5 V	Width	40 mm
• external	24 V	Height	125 mm
Relative positive tolerance at 24 V with DC	20 %	Depth	120 mm
Relative negative tolerance at 24 V with DC	15 %	Net weight	0.3 kg
Consumed current		Product properties, functions, components general	
• from backplane bus at 5 V for DC Typical	0.15 A	Number of modules	
• from external supply voltage at 24 V with DC		• per CPU maximum	4
- typical	0.25 A	• note	-
- maximum	-	Cable length	
Resistive loss	6 W	• with PCF cable maximum	300 m
		• with POF cable maximum	50 m

PROFIBUS

Communication for SIMATIC S7-300

CP 342-5 FO

Technical specifications (continued)

Article No.	6GK7342-5DF00-0XE0	Article No.	6GK7342-5DF00-0XE0
Product-type designation	CP 342-5 FO	Product-type designation	CP 342-5 FO
Performance data		Performance data	
<u>Performance data open communication</u>		<u>Performance data S7 communication</u>	
Number of possible connections for open communication by means of SEND/RECEIVE blocks maximum	16	Number of possible connections for S7 communication	
Data volume as user data per connection for open communication by means of SEND/RECEIVE blocks maximum	240 byte	• maximum	16
<u>Performance data PROFIBUS DP</u>		• with PG connections maximum	-
Service as DP master DPV0	Yes	• with PG/OP connections maximum	-
Number of DP slaves on DP master usable	124	• note	-
Amount of data		<u>Performance data multi-protocol mode</u>	
• of the address area of the inputs as DP master overall	2 160 byte	Number of active connections with multi-protocol mode	
• of the address area of the outputs as DP master overall	2 160 byte	• without DP maximum	32
• of the address area of the inputs per DP slave	244 byte	• with DP maximum	28
• of the address area of the outputs per DP slave	244 byte	Product functions management, configuration	
• of the address area of the diagnostic data per DP slave	240 byte	Configuration software required	STEP 7 V5.1 SP2 or higher / STEP 7 Professional V12 (TIA Portal) or higher
Service as DP slave			
• DPV0	Yes		
• DPV1	-		
Amount of data			
• of the address area of the inputs as DP slave overall	240 byte		
• of the address area of the outputs as DP slave overall	240 byte		

Ordering data

Article No.

CP 342-5 FO communications processor	6GK7342-5DF00-0XE0
Communication processor for optical connection of SIMATIC S7-300 to PROFIBUS to 12 Mbit/s with electronic manual on CD-ROM	
Accessories	
PROFIBUS Plastic Fiber Optic, Simplex Connector/Polishing Set	6GK1901-0FB00-0AA0
100 simplex connectors and 5 polishing sets for assembling PROFIBUS plastic fiber optic cables for the optical PROFIBUS DP	
PROFIBUS Plastic Fiber Optic, stripping tool set	6GK1905-6PA10
Tools for removing the outer sheath or core sheath of Plastic Fiber Optic cables	
Plug-in adapter	6ES7195-1BE00-0XA0
For assembling the plastic Simplex connector in combination with CP 342-5 FO, IM 467 FO, IM 153-2 FO and IM 151 FO	
50 units	

Note:

For software ordering data, see page 3/178

Overview



DP-M	DP-S	FMS	PG/OP	S7/S5	
●			●	●	●

- PROFIBUS DP master with electrical interface for connecting the SIMATIC S7-400 to PROFIBUS at up to 12 Mbit/s (including 45.45 Kbit/s)
- For setting up additional PROFIBUS DP lines
- Communication services:
 - PROFIBUS DP
 - PG/OP communication
 - S7 communication
 - Open communication (SEND/RECEIVE)
- Time synchronization
- Easy programming and configuration over PROFIBUS
- Cross-network programming device communication through S7 routing
- Can be easily integrated into the SIMATIC S7-400 system
- Module replacement without PG
- SIMATIC H system operation for redundant S7 communication or DP master communication
- Data record routing (PROFIBUS DP)
- Adding or modifying distributed I/O during operation

Benefits



- Increased plant availability thanks to redundant connection of the process I/O (e.g. ET 200M) in the SIMATIC S7-400 H system
- Particularly suitable for closed-loop control tasks thanks to SYNC/FREEZE and equidistant bus cycle
- Sub-process-oriented design of an automation solution through the use of several CPs
- Universal application of the CP due to the parallel use of different communication services on one CP
- Lower costs due to flexible and reaction-free commissioning by means of CiR (Configuration in RUN)

Application

The CP 443-5 Extended is the communications processor of the SIMATIC S7-400 for the PROFIBUS bus system.

It relieves the CPU of communication tasks and supports additional connections.

Communication possibilities of the S7-400 using communication modules:

- As master for PROFIBUS DP according to IEC 61158/EN 50170
- Communication with programming devices and HMI devices
- Communication with other SIMATIC S7 systems
- Communication with SIMATIC S5 programmable controllers

The number of CPs that can be used is dependent on the performance range of the CPU and on the communications services used.

Design

The CP 443-5 Extended communications processor features all the advantages of the SIMATIC S7-400 design:

- Compact construction; 9-pin Sub-D socket for connection to PROFIBUS DP
- Single-width module
- Easy installation; the CP 443-5 is mounted on the S7-400 rack and connected to the other modules of the S7-400 by means of the backplane bus.
- User-friendly wiring; the Sub-D socket is easily accessible and simple to operate.
- The CP 443-5 Extended can be operated without a fan. A backup battery or memory module is not required
- A maximum of 14 CPs can be operated.

If the CP 443-5 Extended is used as a DP Master, at least four and as many as 10 additional PROFIBUS DP lines can be set up in the central rack. The number of possible PROFIBUS DP lines depends on the SIMATIC S7-400 CPU that is used.

When using S7-communication, no slot allocation rules apply. The number of operable S7 connections depends on the S7-400 CPU.

When using SEND/RECEIVE, the number of operable DP modules also depends on the S7-400 CPU.

PROFIBUS

Communication for SIMATIC S7-400

CP 443-5 Extended

Function

The CP 443-5 Extended provides access to different communication services of the PROFIBUS bus system:

- PROFIBUS DP (according to IEC 61158/61784)
- PG/OP communication
- S7 communication (S7 controllers)
- Open communication (SEND/RECEIVE)
- Time synchronization

Master for PROFIBUS DP

The CP 443-5 Extended operates as DP-V1 master. It processes data transfer autonomously and allows slaves to be connected, such as CP 342-5 as DP slave, DP slaves of the ET 200 distributed I/O system, etc. This means that the CP 443-5 Extended is able to connect the S7-400 station to PROFIBUS DP and is the ideal expansion to the integral DP master interfaces of the S7-400 CPUs for establishing additional PROFIBUS DP lines.

The CP 443-5 Extended can also be used in the SIMATIC S7 H system as a redundant DP master.

The CP 443-5 Extended is a DP-V1 master, i.e. it also supports the acyclic standard services incl. interrupt handling.

The CP 443-5 Extended also supports the SYNC and FREEZE functions, constant bus cycle time, direct slave-to-slave traffic, data set routing and changes to the configuration of the assigned distributed I/O during normal operation.

During normal operation, it is also possible to activate or deactivate DP slaves. This supports the step-by-step start-up of subprocesses, for example.

A diagnostic repeater allows the line to be diagnosed during operation, enabling line faults to be detected at an early stage. The CP 443-5 Extended supports operation with diagnostic repeater (including activation of topology identification in the diagnostic repeater).

The distributed I/Os are handled like central I/Os from the user's point of view. This means that there are no differences between the CP 443-5 Extended and the integral DP master interface of the S7-400 CPU with regard to configuration and parameterization. Depending on the scale of the system, the CP 443-5 Extended has extremely short response times.

PG/OP communication

PG/OP communication allows all S7 stations connected to the network to be remotely programmed.

- S7 routing
With the aid of routing it is possible to use programming device communication across networks.

S7 communication

S7 communication is used for the coupling

- between SIMATIC S7 programmable controllers
- to programming devices (PG/OP communication)
- to PCs, e.g. CP 5711 with SOFTNET-PB S7, CP 5623 etc.
- to HMI devices (OPs).

For redundant S7 communication, the CP 443-5 Extended can also be used in SIMATIC H systems.

Open communication (SEND/RECEIVE)

SIMATIC S7-400 is integrated into existing systems by means of open communication.

Based on Layer 2 (FDL) of PROFIBUS, the CP 443-5 Extended offers a simple, optimized interface for process or field communication. This interface offers uniform, high-performance communication between SIMATIC S5, SIMATIC S7 and the PC. It provides the services SDA (PLC/PLC connections) and SDN (Broadcast, Multicast).

The communication partners are the programmable controllers

- SIMATIC S7
with CP 342-5, CP 343-5, CP 443-5 Extended and Basic
- SIMATIC S5
with S5-95U with PROFIBUS interface, S5-115U/H, S5-135U, S5-155U/H with CP 5431 FMS/DP
- SIMATIC 505
with CP 5434-FMS
- PCs
with CP 5512, CP 5611 A2, CP 5621, CP 5613 A3, CP 5613 FO, CP 5614 A3, CP 5623, CP 5624
- Non-Siemens systems that are equipped with an FDL interface.

To use SEND/RECEIVE, function calls are required (PLC-SEND/PLC-RECEIVE), which must be linked into the STEP 7 user program.

Function (continued)

Time synchronization

Time synchronization is used to set the time of day throughout the plant.

The CP 443-5 Extended is capable of forwarding the time of day of the S7-400 CPU to PROFIBUS. Conversely, the CP of the S7-400 CPU can make an existing time of day available on PROFIBUS

The CP 443-5 Extended supports

- The time-stamping of distributed process signals in combination with IM 153
- Time status value, daylight-saving time changeover, synchronization status

Data set routing

The CP 443-5 Extended supports the data set routing function. With this option, the CP can be used as a router for data sets that have to be sent to field devices (DP slaves). SIMATIC PDM (Process Device Manager) is a tool that creates data sets of this type for parameterizing and diagnosing field devices.

Application:

It is possible, for example, to use SIMATIC PDM (on the PC) to set parameters and perform diagnostics for a PA field device over Industrial Ethernet, S7-400 (CP 443-1, CP 443-5 Extended) and DP/PA Coupler/Link.

Diagnostics data

Extensive diagnostic options are available via STEP 7, including:

- Status of the CP
- General diagnostics and statistics functions
- Connection diagnostics
- Bus statistics
- Message buffer
- Support of operation with diagnostic repeater

CiR – Configuration in RUN

With CiR, it is possible to add or modify distributed I/O devices during normal operation.

- Adding PROFIBUS DP/PA slaves
- Adding/removing modules (e.g. I/O modules) in a modular DP slave (e.g. ET 200M and DP/PA Link)

Configuration

STEP 7 V5.1 SP2 or higher, or STEP 7 Professional V12 (TIA Portal) or higher, is required for configuring the full functional scope of the CP 443-5 Extended.

DP configuration/programming is performed for the CP 443-5 Extended in the same manner as for DP configuration/programming of the integrated DP interfaces of the SIMATIC S7-400 CPUs with STEP 7.

The configuring data of the CPs are always saved on the CPU and are retained even after a PLC failure. A module can therefore be replaced without having to reload the configuration data from a programming device. The CPU transfers the configuration data to the CP during start-up.

Configuration and programming of all SIMATIC S7 controllers connected to the network is possible over the network.

The function blocks for using the open communication (SEND/RECEIVE) can be found in the SIMATIC NET library following installation of STEP 7.

PROFIBUS

Communication for SIMATIC S7-400

CP 443-5 Extended

Technical specifications

Article No.	6GK7443-5DX05-0XE0	Article No.	6GK7443-5DX05-0XE0
Product-type designation	CP 443-5 Extended	Product-type designation	CP 443-5 Extended
Transmission rate		Performance data	
Transmission rate at interface 1 in accordance with PROFIBUS	9.6 kbit/s ... 12 Mbit/s	<u>Performance data open communication</u>	
Interfaces		Number of possible connections for open communication by means of SEND/RECEIVE blocks maximum	32
Number of electrical connections at interface 1 in accordance with PROFIBUS	1	Data volume as user data per connection for open communication by means of SEND/RECEIVE blocks maximum	240 byte
Design of electrical connection at interface 1 in accordance with PROFIBUS	9-pin Sub-D socket (RS485)	<u>Performance data PROFIBUS DP</u>	
Supply voltage, current consumption, power loss		Service as DP master DPV1	Yes
Type of supply voltage	DC	Number of DP slaves on DP master usable	125
Supply voltage 1 from backplane bus	5 V	Amount of data	
Relative symmetrical tolerance at 5 V with DC	5 %	• of the address area of the inputs as DP master overall	4 096 byte
Consumed current from backplane bus at 5 V for DC Typical	0.6 A	• of the address area of the outputs as DP master overall	4 096 byte
Resistive loss	5.5 W	• of the address area of the inputs per DP slave	244 byte
Permitted ambient conditions		• of the address area of the outputs per DP slave	244 byte
Ambient temperature		<u>Performance data S7 communication</u>	
• during operating	0 ... 60 °C	Number of possible connections for S7 communication	
• during storage	-40 ... +70 °C	• maximum	48
• during transport	-40 ... +70 °C	• with PG connections maximum	-
• Comment	-	• with PG/OP connections maximum	-
Relative humidity at 25 °C without condensation during operating maximum	95 %	• note	-
Protection class IP	IP20	<u>Performance data multi-protocol mode</u>	
Design, dimensions and weight		Number of active connections with multi-protocol mode	
Module format	Compact module S7-400 single width	• without DP maximum	59
Width	25 mm	• with DP maximum	54
Height	290 mm	Product functions management, configuration	
Depth	210 mm	Configuration software required	STEP 7 V5.4 SP4 or higher / STEP 7 Professional V12 (TIA Portal) or higher
Net weight	0.65 kg		
Product properties, functions, components general			
Number of modules			
• per CPU maximum	14		
• note	The number of CPs that can be operated as DP masters depends on the number of CP 443-1 Advanced processors operating in the S7-400 station as PROFINET IO controllers. Up to 10 CPs can be operated in total: up to 4 as PROFINET IO controllers (CP 443-1 Advanced); up to 10 as DP masters (CP 443-5 Extended)		

Ordering data	Article No.
<p>Communications processor CP 443-5 Extended</p> <p>for connection of the SIMATIC S7-400 to PROFIBUS</p> <p>Extended version for PROFIBUS DP; with electronic manual on CD-ROM</p>	6GK7443-5DX05-0XE0
<i>Accessories</i>	
<p>PROFIBUS FastConnect connection plug RS485</p> <p>With 90° cable outlet; insulation displacement technology, max. transmission rate 12 Mbit/s</p> <ul style="list-style-type: none"> • Without PG interface 	6ES7972-0BA52-0XA0
<p>PROFIBUS bus connector IP20</p> <p>With connection to PPI, MPI, PROFIBUS</p> <ul style="list-style-type: none"> • Without PG interface • With PG interface 	6ES7972-0BA12-0XA0 6ES7972-0BB12-0XA0
<p>PROFIBUS FC Standard Cable</p> <p>2-core bus cable, shielded, special design for fast mounting, delivery unit: max. 1 000 m, minimum order 20 m, sold by the meter</p>	6XV1830-0EH10
<p>PROFIBUS bus terminal 12M</p> <p>Bus terminal for connection of PROFIBUS nodes at up to 12 Mbit/s with connecting cable</p>	6GK1500-0AA10

Note:

For software ordering data, see page 3/178

PROFIBUS

Communication for SIMATIC S7

Software

Ordering data

Article No.

Article No.

Software

STEP 7 Professional Engineering Software (TIA Portal)

Target system:
SIMATIC S7-1200, S7-1500, S7-300, S7-400, WinAC

Requirement:
Windows 7 Professional (64 bit),
Windows 7 Enterprise (64 bit),
Windows 7 Ultimate SP1 (64 bit),
Windows 8.1 (64 bit),
Windows 8.1 Professional (64 bit),
Windows 8.1 Enterprise (64 bit),
Windows Server 2008 R2 StdE
(full installation),
Windows Server 2012 StdE
(full installation)

Form of delivery:
German, English, Chinese, Italian,
French, Spanish

*For CM 1242-5, CM 1243-5,
CM 1542-5, CP 1542-5, CP 342-5,
CP 342-5 FO, CP 443-5 Extended*

- STEP 7 Professional V13, Floating License
- STEP 7 Professional V13, Trial License
- Upgrade STEP 7 Professional V12 to STEP 7 Professional V13, Floating License
- Upgrade STEP 7 Professional 2006/2010 to STEP 7 Professional 2010/V13, Floating License
- PowerPack & upgrade from STEP 7 V5.4/V5.5 to STEP 7 Professional 2010/V13, Floating License
- PowerPack STEP 7 Basic V13 to STEP 7 Professional V13, Floating License

6ES7822-1AA03-0YA5

6ES7822-1AA03-0YA7

6ES7822-1AA03-0YE5

6ES7822-1AA03-0XE5

6ES7822-1AA03-0XC5

6ES7822-1AA03-0YC5

STEP 7 Professional engineering software V13; software download incl. license key¹⁾

E-mail address required for the delivery

- STEP 7 Professional V13, Floating License
- Upgrade STEP 7 Professional V12 to STEP 7 Professional V13, Floating License
- Upgrade STEP 7 Professional 2006/2010 to STEP 7 Professional 2010/V13, Floating License
- PowerPack & upgrade from STEP 7 V5.4/V5.5 to STEP 7 Professional 2010/V13, Floating License
- PowerPack STEP 7 Basic V13 to STEP 7 Professional V13, Floating License

6ES7822-1AE03-0YA5

6ES7822-1AE03-0YE5

6ES7822-1AE03-0XE5

6ES7822-1AE03-0XC5

6ES7822-1AA03-0YC5

STEP 7 Basic Engineering Software V13 (TIA Portal)

Target system:
SIMATIC S7-1200, S7-1500, S7-300, S7-400, WinAC

Requirement:
Windows 7 Professional (64 bit),
Windows 7 Enterprise (64 bit),
Windows 7 Ultimate SP1 (64 bit),
Windows 8.1 (64 bit),
Windows 8.1 Professional (64 bit),
Windows 8.1 Enterprise (64 bit),
Windows Server 2008 R2 StdE
(full installation),
Windows Server 2012 StdE
(full installation)

Form of delivery:
German, English, Chinese, Italian,
French, Spanish

For CM 1242-5, CM 1243-5

- STEP 7 Basic V13, Floating License
- STEP 7 Basic V13, Trial License
- Upgrade STEP 7 Basic V12 to STEP 7 Professional V13, Floating License

6ES7822-0AA03-0YA5

6ES7822-0AA03-0YA7

6ES7822-0AA03-0YE5

Software Update Service

For a period of 12 months and for a fixed price, the customer is automatically provided with all upgrades and service packs for each installed software package. The contract is automatically extended by a further year unless canceled at least 12 weeks prior to expiration.

Requires the current software version.

- STEP 7 Basic V1x, Software Update Service Standard, 1 year
- STEP 7 Basic V1x, Software Update Service Compact, 1 year

6ES7822-0AA00-0YL0

6ES7822-0AA00-0YM0

STEP 7 Version 5.5

Target system:
SIMATIC S7-300/400, SIMATIC C7, SIMATIC WinAC

Requirements:
Windows XP Prof.,
Windows 7 Professional/Ultimate

Type of delivery:
German, English, French, Spanish, Italian;
including license key on USB stick, with electronic documentation

For CP 342-5, CP 342-5 FO, CP 443-5 Extended

- Floating License on DVD
- Rental License for 50 hours
- Software Update Service on DVD (requires current software version)
- Floating license upgrade 3.x/4.x/5.x to V5.4; on DVD
- Trial license STEP 7 V5.4; on DVD, operational for 14 days

6ES7810-4CC10-0YA5

6ES7810-4CC10-0YA6

6ES7810-4BC01-0YX2

6ES7810-4CC10-0YE5

6ES7810-4CC10-0YA7

¹⁾ For up-to-date information and download availability, see: <http://www.siemens.com/tia-online-software-delivery>

Overview

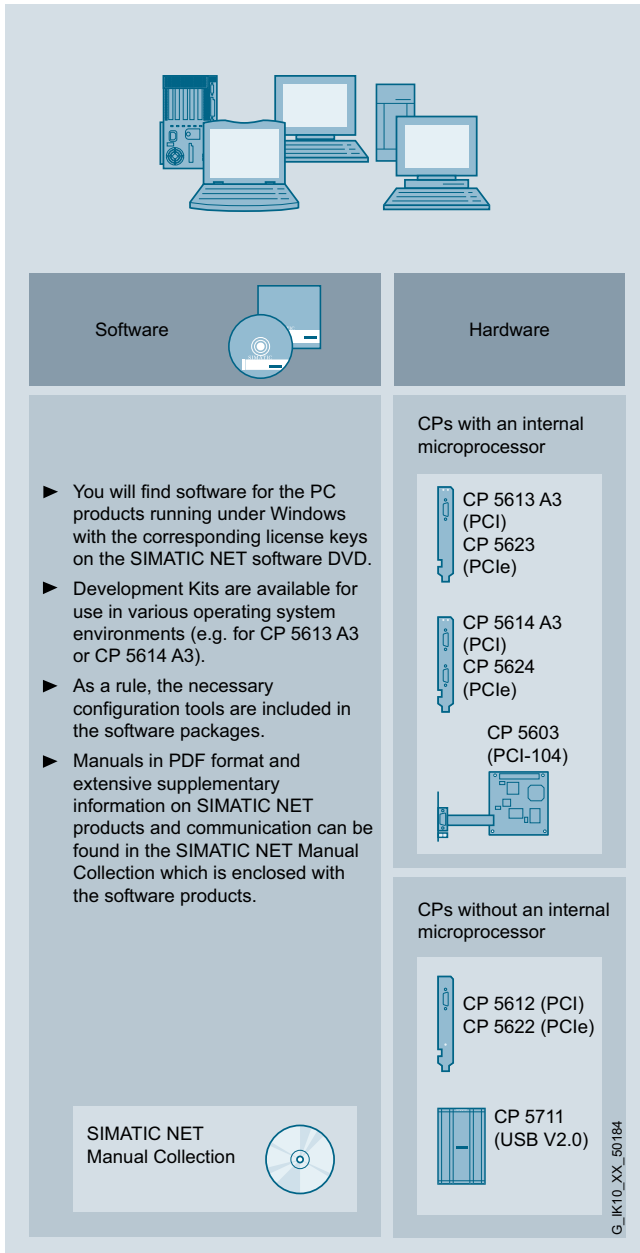

System connection for PG/PC

PC card with an internal microprocessor

Recommended solution for:

- PC-based control systems (Soft Control, PLC, Numeric Control, Robot Control)
- Process control systems
- Operator control and monitoring systems (HMI)
- PROFIBUS DP slave connection (CP 5614 A3, CP 5624)
- PROFIBUS plants with large quantity framework (more than 8 stations)
- Multi-protocol operation
- Use of several CPs in one system

PC card without an internal microprocessor

Recommended solution for:

- Configuring tools (e.g. STEP 7)
- PROFIBUS DP diagnostics station (e.g. as DP master Class 2)
- PROFIBUS DP slave connection
- PROFIBUS systems with up to 8 stations
- Mono protocol mode

PROFIBUS

Communication for PC-based systems

Performance data

Overview

The following communications processors are available for connecting to the programming device or PC:

- CPs with an internal microprocessor:
CP 5613 A3 (PCI), CP 5614 A3 (PCI), CP 5623 (PCle), CP 5624 (PCle), CP 5603 (PCI-104)
- CPs without an internal microprocessor:
CP 5612 (PCI), CP 5622 (PCle), CP 5711 (USB)

Performance of PROFIBUS CPs

The maximum performance specifies how much digital input/output data can be read or written in 1 ms from the PROFIBUS application over the respective PROFIBUS CP (regardless of the physical characteristics of the bus).

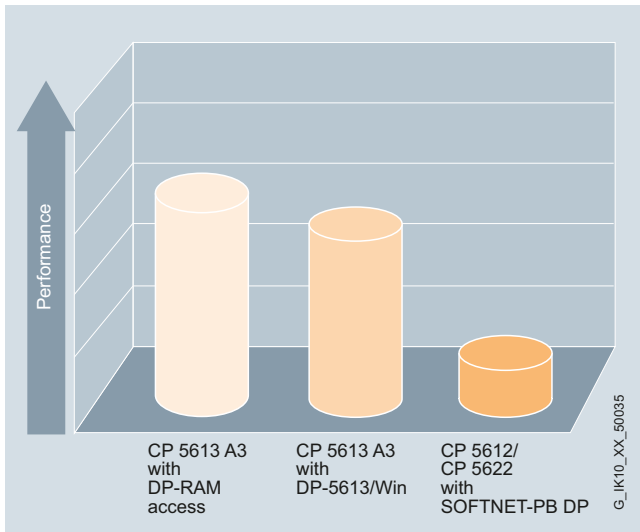

Performance under almost identical CPU loading

CPU loading and access time

If event access (using interrupts) and polling access are compared, it can be shown that the CPU loading can be significantly reduced with the CP 5613 A3 using the event/filter mechanism – for the same data throughput.

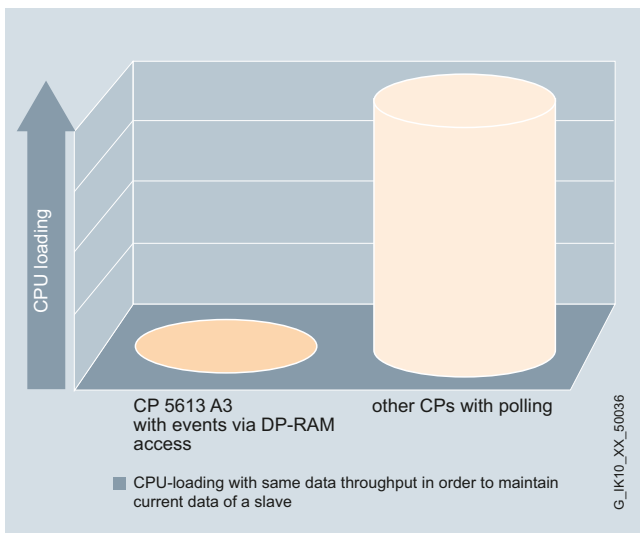

Comparison of loading on the CPU with event access and with polling access

Performance data of PROFIBUS CPs

		CP 5613 A3	CP 5614 A3	CP 5612/ CP 5622
Number of connectable DP slaves	max	124	124	64
Number of FDL tasks waiting	max	80	80	50
Number of PG/OP and S7 connections	max	50 ¹⁾	50 ¹⁾	8

Note:

¹⁾ With credit = 1; PDU size ≤ 480 bytes

Configuration for SIMATIC NET version V12 or higher:

STEP 7 V12 or higher is used for PC configuration. The STEP 7 software is included in the scope of delivery of the SIMATIC NET software products. A STEP 7 license is not required for PC configuration.

Configuration for SIMATIC NET versions up to V8.2:

The PC can be configured either in STEP 7 or in NCM PC Version V5.1+SP2 and higher. Both tools offer the same 'look & feel' and create the same database. This enables integrated configuration of the open communication and S7 communication functions. Data only has to be entered once and data consistency is assured.

- A configuration wizard integrated into NCM PC also supports user-driven configuration of the PC station.
- With NCM PC and STEP 7 from Version V5.1+SP2 upwards, a PC similar to a SIMATIC S7 station can be configured and loaded over a network. This applies both to the local station on which NCM PC or STEP 7 is installed and to the remote station that is addressed over the network.

Note:

NCM PC does not contain a conversion function for LDBs that were created using COM1 S7. Reconfiguration is necessary.

More information

You can find more information on the Internet at:

<http://support.automation.siemens.com/WW/view/en/15227599>

Overview

Communication hardware	Communication software	Operating system environment of the communication software								SIMATIC Industrial PC/ Field PG								Embedded Systems				
		Windows 7 Professional / Ultimate SP1	Windows 8.1 Pro / Enterprise	Windows Server 2008 R2 SP1	Windows Server 2012 R2	Windows Server 2008 + SP1/2	Windows XP Pro + SP3	Windows Server 2003 R2 / SP2	other operating systems	Field PG M4	SIMATIC IPC227D + IPC 277D	SIMATIC IPC427D + IPC 477D	SIMATIC IPC547E	SIMATIC IPC627D	SIMATIC IPC647D	SIMATIC HMI IPC677D	SIMATIC IPC827D	SIMATIC IPC847D	Windows Embedded Standard 2009	Windows Embedded Standard 7 + SP1	SIMATIC IPC427D + 477D + IPC 227D/277D	SIMATIC S7 modular Embedded Controller
CPs and software for PROFIBUS																						
CP 5603 (PCI-104)	CP with DP-Base	●	●	●	●	●	●	●			●								●	●	●	
	HARDNET-PB DP DK 1)	○	○	○	○	○	○	○	○		○								○	○	○	○ ⁵⁾
	HARDNET-PB DP	●	●	●	●	●	●	●	●		●								●	●	●	
	HARDNET-PB S7	●	●	●	●	●	●	●	●		●								●	●	●	
CP 5613 A2, CP 5614 A2 (PCI 32 Bit)	CP with DP-Base	●	●	●	●	●	●	●			●	●	●	●	●	●						
	HARDNET-PB DP DK 1)	○	○	○	○	○	○	○	○		○	○	○	○	○	○			○	○		
	HARDNET-PB DP	●	●	●	●	●	●	●	●		●	●	●	●	●	●						
	HARDNET-PB S7	●	●	●	●	●	●	●	●		●	●	●	●	●	●						
CP 5613 A3, CP 5614 A3 (PCI 32 Bit)	CP with DP-Base	●	●	●	●	●	●	●			●	●	●	●	●	●						
	HARDNET-PB DP DK 1)	○	○	○	○	○	○	○	○		○	○	○	○	○	○			○	○		
	HARDNET-PB DP	●	●	●	●	●	●	●	●		●	●	●	●	●	●						
	HARDNET-PB S7	●	●	●	●	●	●	●	●		●	●	●	●	●	●						
CP 5623, CP 5624 (PCIe x1)	CP with DP-Base	●	●	●	●	●	●	●			●	○ ⁴⁾		○ ⁴⁾	●	● ⁴⁾				●		
	HARDNET-PB DP DK 1)	○	○	○	○	○	○	○	○		○	○		○ ⁴⁾	○	○			○	○		
	HARDNET-PB DP	●	●	●	●	●	●	●	●		●	○ ⁴⁾		○ ⁴⁾	●	● ⁴⁾				●		
	HARDNET-PB S7	●	●	●	●	●	●	●	●		●	○ ⁴⁾		○ ⁴⁾	●	● ⁴⁾				●		
CP 5612 (PCI 32 Bit)	SOFTNET-PB DP	●	●	●	●	●	●	●			●	●	●	●	●	●						
	SOFTNET-PB DP Slave	●	●	●	●	●	●	●			●	●	●	●	●	●						
	SOFTNET-PB S7	●	●	●	●	●	●	●			●	●	●	●	●	●						
	S7 OPC Redundancy for PROFIBUS			●							●		●		●							
CP 5622 (PCIe x1)	SOFTNET-PB DP	●	●	●	●	●	●	●		●	●	○ ⁴⁾		○ ⁴⁾	●	● ⁴⁾				●		
	SOFTNET-PB DP Slave	●	●	●	●	●	●	●		●	●	○ ⁴⁾		○ ⁴⁾	●	● ⁴⁾				●		
	SOFTNET-PB S7	●	●	●	●	●	●	●		●	●	○ ⁴⁾		○ ⁴⁾	●	● ⁴⁾				●		
	S7 OPC Redundancy for PROFIBUS			●							●		●		●							
CP 5711 (USB V2.0)	SOFTNET-PB DP	●	●	●	●	●	●	●		●	●	●	●	●	●	●			●	●	●	●
	SOFTNET-PB DP Slave	●	●	●	●	●	●	●		●	●	●	●	●	●	●			●	●	●	●
	SOFTNET-PB S7	●	●	●	●	●	●	●		●	●	●	●	●	●	●			●	●	●	●
	S7 OPC Redundancy for PROFIBUS			●						●		●		●		●						●
SIMATIC PG/PC	SOFTNET-PB DP	●	●	●	●	●	●	●		●		○ ²⁾		○ ²⁾	○ ²⁾	○ ²⁾	○ ²⁾		●	●	○ ²⁾	
	SOFTNET-PB DP Slave	●	●	●	●	●	●	●		●		○ ²⁾		○ ²⁾	○ ²⁾	○ ²⁾	○ ²⁾		●	●	○ ²⁾	
	SOFTNET-PB S7	●	●	●	●	●	●	●		●		○ ²⁾		○ ²⁾	○ ²⁾	○ ²⁾	○ ²⁾		●	●	○ ²⁾	
	S7 OPC Redundancy for PROFIBUS			●										○ ²⁾								

1) In order to use these CPs in other operating system environments, it is required to port HARDNET DP Development Kits (DK-5613) into the respective operating system. You can request the HARDNET DP DK in the Internet under www.siemens.com/simatic-net/dk5613.
 2) integrated PROFIBUS interface is optional
 3) depending on available memory and processor performance there could be restrictions
 4) Observe restrictions for some PC versions: Number of slots and tolerable maximum heat loss/ power consumption per slot and in total
 5) EM-PCI 104 expansion module is required

Notes
 - Please always note the supplementary conditions for the specified SIMATIC NET products that you can view on the Internet pages shown below.
 - for further details on XP embedded, see <http://support.automation.siemens.com/WWW/view/en/21661049>
 - further details on system requirements and operating environments can be found in the Readme file of the communication products on the SIMATIC NET PC Software DVD
 - Updates and supplements to the catalog entries, as well as the above tables can be viewed at <http://www.siemens.com/simatic-net/ik-info>

● suitable
 ○ not suitable
 ○ suitable under certain conditions

G_IK10_XX_50025

Connection options of PROFIBUS CPs to PG/PC

Note:
 The operating systems listed refer exclusively to the communication products specified!

For the actual operating system that is available and has been released, please refer to the description of the corresponding IPC.



PROFIBUS

Communication for PC-based systems

CP 5603

Overview

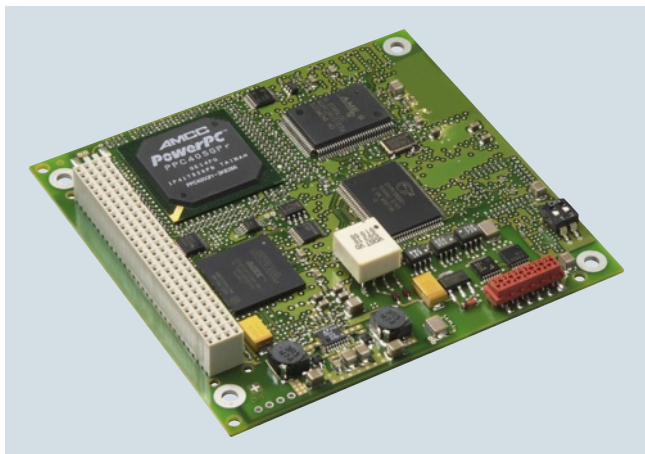

DP-M	DP-S	FMS	OPC	PG/OP	S7/S5
●	●	●	●	●	●

- PCI-104 interface card with own microprocessor for connecting embedded systems with PCI-104 interface to PROFIBUS at up to 12 Mbit/s
- Function compatible with CP 5613 A2
- Communication services:
 - PROFIBUS DP master Class 1 and 2 or DP slave according to IEC 61158/61784
 - PG/OP communication with STEP 5 and STEP 7
 - S7 communication with HARDNET-PB S7 software package
 - Open communication (SEND/RECEIVE) based on the FDL interface
 - PROFIBUS FMS according to IEC 61158/61784 with FMS-5613 software package
- Extensive diagnostics options for installation, commissioning and operation of the module
- Event and filter mechanism for reducing the load on the host CPU
- Multiprotocol operation and parallel operation of up to three CPs
- The appropriate OPC server and configuration tools are included in the scope of delivery of the respective communication software
- Development kit with driver sources for integration into "non-Windows" environments

Note:

FMS-5613 supports up to two CP 5603/CP 5613 A2/5614 A2/CP 5623/CP 5624 processors

Benefits

get **Designed for Industry**

- Fast process data exchange; access to process data by means of direct access to the dual port RAM of the hardware
- High computing performance in the PG/PC; reduces workload of host CPU by preprocessing the communication on the hardware
- Use of different operating system environments; driver as source code for porting to different operating system environments
- Use also in motion control applications; real-time capable data exchange through constant bus cycle time

Application



The CP 5603 allows the connection of embedded systems with a PC/104 Plus interface to PROFIBUS.

The CP 5603 also provides high-performance support to control tasks on the embedded system (PC-based Control, Numeric Control, Robot Control).

Function

PROFIBUS DP

Access to process data with DP-Base

The CP 5603 is operated as PROFIBUS DP master module that keeps the process image (input/output and diagnostics data) in the dual port RAM (memory area on the CP). The hardware of the CP 5603 independently executes the high-performance exchange of data with the PROFIBUS slaves. The user accesses the dual-port RAM directly.

The process data of the slaves is always consistent, i.e. the user receives the data of a slave from one and the same DP cycle.

Parallel operation of the HARDNET-PB DP and DP-Base software is not possible.

Event filter mechanism

The user receives up-to-date data over two access mechanisms:

- Cyclic polling of the DP slaves (higher loading for host CPU)
- Notification through a new type of event/filter mode on changing the input data of a slave (minimal loading for host CPU)

Both alternatives can be combined. This allows users to optimize use of the PC for their applications.

The event/filter mechanism can be used additionally for

- Notification by means of an interrupt of the diagnostic messages from slaves
- During operation with constant bus cycle time, signaling by means of interrupt:
 - Start DP cycle
 - End of cyclic data exchange with DP slaves

FastLogic

FastLogic means that the CP 5603 can react autonomously to as many as 4 plant statuses. This results in a short response time and independence from the host application, e.g. fast shutdown of devices.

DP programming interface

The DP programming interface (DP-Base) of the CP 5603 has the following functionality:

- DP master class 1 including acyclic DP expansions
- DP master class 2 including acyclic DP expansions
- DP slave

The process data is accessed directly through the dual-port RAM. The DP RAM interface not only offers fast access as DP master/slave but also a basis for porting to other operating system environments (e.g. VXWorks, QNX, RMOS, RTX).

Administrative function calls (initialization and management services), as well as diagnostic functions) are provided through a library (DP_BASE.DLL or DPS_BASE.DLL).

HARDNET-PB DP Development Kit

The HARDNET-PB DP Development Kit provides access to the functions DP master Class 1 including acyclic DP expansions

The HARDNET-PB DP Development Kit software enables the CP 5603 communications processor to be integrated into any operating system environments. The kit contains the necessary source code, including the descriptions in PDF format, and can be downloaded free of charge from the Internet.

Access to process data with HARDNET-PB DP

HARDNET-PB DP is available to permit compatibility with older applications that were created with the DP-Lib interface.

Parallel operation of the DP-Base and HARDNET-PB DP software is not possible.

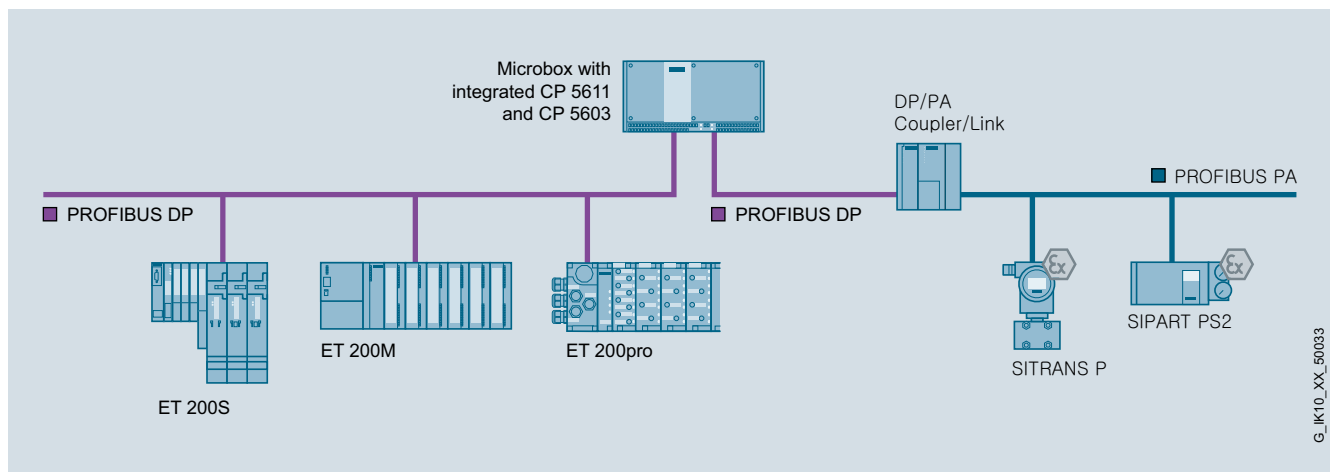

PROFIBUS DP connection with embedded PC SIMATIC Microbox

PROFIBUS

Communication for PC-based systems

CP 5603

Function (continued)

Software for PG/OP communication

This software supports programming of the SIMATIC S5/S7 controllers (with the exception of SIMATIC S5-95U) over PROFIBUS in combination with STEP 5/STEP 7. The PG/OP communication for the CP 5603 is already available following installation of the CP 5603 (DP-Base). No additional software packages are required.

Open communication (SEND/RECEIVE based on the FDL interface)

SEND/RECEIVE (FDL interface) is already available following installation of the CP 5603 (DP-Base) and provides services for data transfer, diagnostics and management. No additional software packages are required.

Software for S7 communication (HARDNET-PB S7)

SIMATIC S7 system components communicate with each other using S7 communication functions. The S7 programming interface provides programming device/PC user programs with access to SIMATIC S7 system components. This provides easy, flexible access to the data of the SIMATIC S7 controller.

The following services are available with S7 communication:

Administrative services

- Connection management
- Mini database
- Trace

Data transfer services

- Read/write variables
- BSEND/BRECEIVE (up to 64 KB per task)

Software for PROFIBUS FMS (FMS-5613)

With the FMS programming interface, PGs/PCs can exchange different manufacturer data with FMS-capable controllers (e.g. S5 and S7) and field devices. Open communication is assured by using the FMS interface.

The FMS interface offers the following services:

- Administrative services
- CRL management services
- FMS connection management services
- Object directory management services for clients and server
- Variable services for clients and servers (Read, Write, Information Report)
- Server functionality
- VFD services (Virtual Field Device) for clients and servers
- Bus access information services (live list)
- Trace and mini database

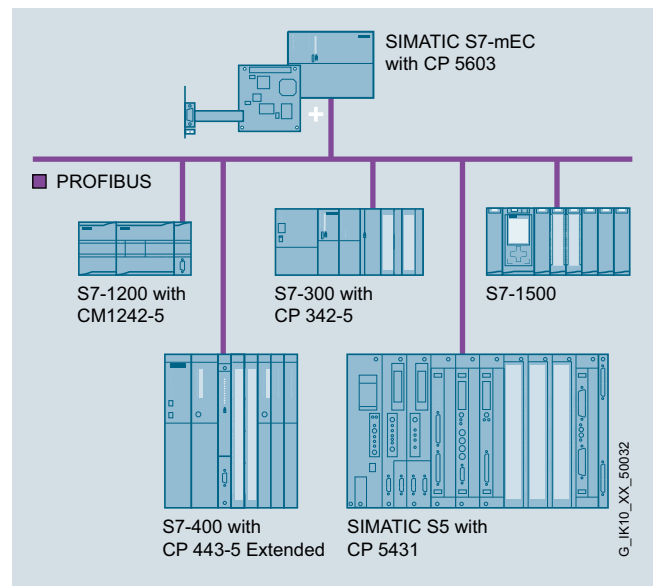

Connecting the SIMATIC to the S7 modular embedded controller via PROFIBUS

Function (continued)

User interfaces

OPC interface

The OPC server included in the respective software package can be used as the standard programming interface for the PROFIBUS DP, open communication, S7 communication and PROFIBUS FMS in order to connect automation technology applications to OPC-compatible Windows applications (Office, HMI systems, etc.)

Programming interface through C library

The programming interfaces for existing applications are implemented as Dynamic Link Libraries (DLL). The released compilers can be found in the readme file of the SIMATIC NET CD products at <http://www.siemens.com/automation/csi/net>.

For Borland programming interfaces (e.g. DELPHI), partner solutions from SoftwareOption are offered.

For solutions for other operating systems, see HARDNET-PB DP Development Kit.

Configuration

- The S7 communication, open communication and DP-V0/DP-V1/DP-V2 protocols are configured in STEP 7 or NCM PC.
- A configuration tool is included in the scope of delivery of the PROFIBUS software packages.

Diagnostics

Comprehensive diagnostic tools are available (for installation, start-up and operation) for the module itself and for the PROFIBUS DP network. These tools can be used for quick and easy start-up of a PROFIBUS network with a CP 5603.

Technical specifications

Article No.	6GK1560-3AA00
Product-type designation	CP 5603
Transmission rate	
Transmission rate at interface 1 in accordance with PROFIBUS	9.6 kbit/s ... 12 Mbit/s
Interfaces	
Number of electrical connections at interface 1 in accordance with PROFIBUS	1
Design of electrical connection	
• at interface 1 in accordance with PROFIBUS	9-pin Sub-D socket (RS 485)
• of the backplane bus	PCI-104 (32Bit)
Supply voltage, current consumption, power loss	
Type of supply voltage	DC
Supply voltage 1 from backplane bus	5 V
Relative symmetrical tolerance at 5 V with DC	5 %
Consumed current 1 from backplane bus with DC maximum	0.66 A
Resistive loss	3.3 W
Permitted ambient conditions	
Ambient temperature	
• during operating	0 ... 70 °C
• during storage	-40 ... +70 °C
• during transport	-40 ... +70 °C
Relative humidity at 25 °C without condensation during operating maximum	85 %
Protection class IP	IP00
Design, dimensions and weight	
Module format	PCI-104
Width	90 mm
Height	21 mm
Depth	96 mm
Net weight	80 g
Mounting type	Screw mounting

Article No.	6GK1560-3AA00
Product-type designation	CP 5603
Product properties, functions, components general	
Number of plug-in cards in the same design can be plugged in per PC station	3
Number of modules note	FMS-5613 supports up to two CP 5603 / CP 5613 A2 / CP 5614 A2 / CP 5623 / CP 5624 processors
Performance data	
<u>Performance data open communication</u>	
Software for open communication by means of SEND/RECEIVE required	FDL driver included in scope of delivery of the CP
Number of possible connections for open communication by means of SEND/RECEIVE maximum	80
<u>Performance data PROFIBUS DP</u>	
Software for DP master function required	No
Service as DP master	
• DPV0	Yes
• DPV1	Yes
• DPV2	Yes
Number of DP slaves on DP master usable	124
Amount of data	
• of the address area of the inputs as DP master overall	30 256 byte
• of the address area of the outputs as DP master overall	30 256 byte
• of the address area of the inputs per DP slave	244 byte
• of the address area of the outputs per DP slave	244 byte
• of the address area of the diagnostic data per DP slave	244 byte

PROFIBUS

Communication for PC-based systems

CP 5603

Technical specifications (continued)

Article No.	6GK1560-3AA00
Product-type designation	CP 5603
Software for DP slave function required	No
Service as DP slave	
• DPV0	Yes
• DPV1	Yes
Amount of data	
• of the address area of the inputs as DP slave overall	244 byte
• of the address area of the outputs as DP slave overall	244 byte
Performance data	
FMS functions	
Software for FMS communication required	Yes, FMS-5613
Number of possible connections for FMS connection maximum	40
Performance data	
S7 communication	
Software for S7 communication required	Yes, HARDNET-PB S7 (S7-5613)
Number of possible connections for S7/PG communication maximum	50
Performance data	
multi-protocol mode	
Number of active connections with multiprotocol mode	50
Number of configurable connections per PC station	207
Product functions management, configuration	
Configuration software required	included in scope of delivery
Product functions Diagnosis	
Product function Port diagnostics	Yes
Standards, specifications, approvals	
Standard	
• for EMC	2004/108/EC
• for safety of CSA and UL	CAN/CSA C22.2 & UL 60950-1, UL 508
• for emitted interference	EN 61000-6-3, EN 61000-6-4
• for interference immunity	EN 61000-6-1, EN 61000-6-2
Verification of suitability	
• CE mark	Yes
• C-Tick	Yes
Accessories	
Accessories	optional: Expansion rack for SIMATIC Microbox and slide-in plate for SIMATIC S7 modular embedded controller

Ordering data

Article No.

CP 5603 communications processor	6GK1560-3AA00
PCI-104 card for connection to PROFIBUS incl. DP-Base software with NCM PC; DP-RAM interface for DP master or DP slave, incl. PG and FDL protocols; single license for one installation, runtime software, software and electronic manual on CD-ROM, Class A, for operating system support see SIMATIC NET software German/English	
CP 5603 Microbox Package	6GK1560-3AU00
for use of CP 5603 in Microbox 420/427B/427C; consisting of CP 5603 module and Microbox expansion frame	
CP 5603 expansion rack	6GK1560-3AA00-0AU0
for use in Microbox 420/427B/427C with mounting material	
CP 5603 mEC Package	6GK1560-3AE00
for use of CP 5603 in SIMATIC S7-MEC; consisting of CP 5603 and withdrawable unit for CP 5603 for installation in the EM PCI-104 expansion module of the SIMATIC S7-MEC	
CP 5603 insert plate	6GK1560-3AA00-0AE0
Metal plate with RS485 cutout for inserting for the S7 modular embedded controller	
Accessories	
PROFIBUS FastConnect bus connector RS485 Plug 180	6GK1500-0FC10
with 180° cable outlet, insulation displacement	
PROFIBUS FC Standard Cable GP	6XV1830-0EH10
Standard type with special design for quick assembly, 2-core, shielded Sold in meter; max. length 1 000 m minimum order 20 m	
PROFIBUS FastConnect Stripping Tool	6GK1905-6AA00
Preset stripping tool for fast stripping of PROFIBUS FastConnect bus cables	
PROFIBUS bus terminal 12M	6GK1500-0AA10
Bus terminal for connection of PROFIBUS stations up to 12 Mbit/s with plug-in cable 1.5 m long	

Note:

For software ordering data, see page 3/227

More information

You can find the HARDNET-PB DP Development Kit on the Internet at:

<http://www.siemens.com/simatic-net/dk5613>

Overview



DP-M	DP-S	FMS	OPC	PG/OP	S7/S5
●	●		●	●	●

- PCI card (universal keyed 5 V/3.3 V) with own microprocessor for connection of PCs and SIMATIC PG/PC to PROFIBUS at up to 12 Mbit/s
- Communication services:
 - PROFIBUS DP master according to IEC 61158/61784 on a PCI card
 - PG/OP communication with STEP 7
 - S7 communication with HARDNET-PB S7 software package
 - Open communication (SEND/RECEIVE) based on the FDL interface
- Comprehensive diagnostics possibilities for installation, commissioning and operation of the module
- High performance over direct dual-port RAM access
- Event and filter mechanisms to reduce the loading on the host CPU
- Multiprotocol operation and parallel operation of up to four CPs
- Implementation in Motion Control applications is possible because a constant bus cycle time is supported
- The appropriate OPC servers and configuration tools are included in the scope of supply of the respective communications software.

Benefits

get **Designed for Industry**

- Fast process data exchange; access to process data by means of direct access to the dual port RAM of the hardware
- High computing performance in the PG/PC; reduces workload of host CPU by preprocessing the communication on the hardware
- Use of different operating system environments; driver as source code for porting to different operating system environments
- Use also in motion control applications; real-time capable data exchange through constant bus cycle time

Application



The CP 5613 A3 supports the connection of a SIMATIC PG/PC and PCs with PCI slot to PROFIBUS.

The CP 5613 A3 provides high-performance support for control tasks on the PC (PC based Control, Numeric Control, Robot Control).

Design

- Short PCI card
- Operation possible in 3.3V and 5V PCI slots (universal keyed)
- 33 MHz or 66 MHz PCI clock
- Operation possible as 32-bit card in a 64-bit PCI X-slot
- 9-pin sub-D socket for connection to PROFIBUS
- Diagnostics LEDs
- Parallel operation of up to four CPs

The module is installed by means of PCI standard mechanisms (Plug&Play).

If the CP 5613 A3 is used as DP master or in a PG/OP on a PROFIBUS DP, the connection is made:

- **to the electrical PROFIBUS** via
 - Bus connector and PROFIBUS bus cable or
 - bus terminal (e.g. bus terminal 12M) and PROFIBUS bus cable
- **to the optical PROFIBUS with OLM** via
 - bus cable with two bus connectors or
 - PROFIBUS plug-in cable 830-1T
- **to the optical PROFIBUS with OBT and integrated interface** via
 - bus cable with two bus connectors or
 - PROFIBUS plug-in cable 830-1T

PROFIBUS

Communication for PC-based systems

CP 5613 A3

Function

PROFIBUS DP

Access to process data with DP-Base

The CP 5613 A3 is operated as a PROFIBUS DP master module that stores the process image (input/output and diagnostic data) in the dual-port RAM (memory area on the CP). High-performance data transfer to and from the PROFIBUS slaves is performed autonomously by the hardware of the CP 5613 A3. The user accesses the dual-port RAM directly.

The process data of the slaves are always consistent, i.e. the user receives the data of a slave from one and the same DP cycle.

Parallel operation of the HARDNET-PB DP and DP-Base software is not possible.

Event filter mechanism

The user receives up-to-date data over two access mechanisms:

- Cyclic polling of the DP slaves (higher loading for host CPU)
- Notification through event/filter mode on changing the input data of a slave (minimal loading for host CPU)

Both alternatives can be combined. This allows users to optimize use of the PC for their applications.

The event/filter mechanism can be used additionally for

- Notification by means of an interrupt of the diagnostic alarms from slaves
- During operation with constant bus cycle time, signaling by means of interrupt:
 - Start DP cycle
 - End of cyclic data communication with DP slaves

FastLogic

FastLogic means that the CP 5613 A3 can react autonomously to 4 plant statuses. This results in a short response time and independence from the host application, e.g. fast shutdown of devices.

DP programming interface

The DP programming interface (DP-Base) of the CP 5613 A3 features the following functions:

- DP master class 1 including acyclic DP expansions
- DP master class 2 including acyclic DP expansions

The process data is accessed directly through the dual-port RAM. The DP RAM interface not only offers fast access as DP master but also a basis for porting to other operating system environments (e.g. VXWorks, QNX, RMOS, RTX).

Administrative function calls (initialization and management services) are offered in a library (DP_BASE.DLL).

HARDNET-PB DP Development Kit

The HARDNET-PB DP Development Kit provides access to the functions DP master Class 1 including acyclic DP expansions.

The HARDNET-PB DP Development Kit is used to integrate the CP 5613 A3 and CP 5614 A3 communications processors into any operating system environment. The kit contains the necessary source code, including the descriptions in PDF format, and can be downloaded free of charge from the Internet.

Access to process data with HARDNET-PB DP

HARDNET-PB DP is available to permit compatibility with older applications that were created with the DP-Lib interface.

Parallel operation of the DP-Base and HARDNET-PB DP software is not possible.

Software for PG/OP communication

This software supports programming of the SIMATIC S7 controllers over PROFIBUS in combination with STEP 7. PG/OP communication is already available after the CP 5613 A3 (DP-Base) has been installed. No additional software packages are required.

Open communication (SEND/RECEIVE) based on the FDL interface

SEND/RECEIVE (FDL interface) is already available following installation of the CP 5613 A3 (DP-Base) and provides services for data transfer, diagnostics and management. No additional software packages are required.

Software for S7 communication (HARDNET-PB S7)

SIMATIC S7 system components communicate with each other using S7 communication functions. The S7 programming interface provides programming device/PC user programs with access to SIMATIC S7 system components. This provides easy, flexible access to the data of the SIMATIC S7 controller.

The following services are available with S7 communication:

Administrative services

- Connection management
- Mini database
- Trace

Data transfer services

- Read/write variables
- BSEND/BRECEIVE (up to 64 KB per task)

User interfaces

- **OPC interface**

The OPC server included in the respective software package can be used as standard programming interface for the PROFIBUS DP, open communication and S7 communication protocols for linking automation technology applications with OPC-capable Windows applications (Office, HMI systems, etc.).

Configuration

- The S7 communication, open communication, DP protocol (DP-V0/DP-V1/DP-V2) protocols are configured in STEP 7 or NCM PC.
- A configuration tool is included in the scope of delivery of the PROFIBUS software packages.

Diagnostics

Comprehensive diagnostic tools are available (for installation, start-up and operation) for the module itself and for the PROFIBUS DP network. These tools can be used for quick and easy start-up of a PROFIBUS network with a CP 5613 A3.

Technical specifications

Article No.	6GK1561-3AA02	Article No.	6GK1561-3AA02
Product-type designation	CP 5613 A3	Product-type designation	CP 5613 A3
Transmission rate		Performance data <u>PROFIBUS DP</u>	
Transmission rate at interface 1 in accordance with PROFIBUS	9.6 kbit/s ... 12 Mbit/s	Software for DP master function required	No
Interfaces		Service as DP master	
Number of electrical connections at interface 1 in accordance with PROFIBUS	1	• DPV0	Yes
Design of electrical connection		• DPV1	Yes
• at interface 1 in accordance with PROFIBUS	9-pin Sub-D socket (RS 485)	• DPV2	Yes
• of the backplane bus		Number of DP slaves on DP master usable	124
Supply voltage, current consumption, power loss		Amount of data	
Type of supply voltage	DC	• of the address area of the inputs as DP master overall	30 256 byte
Supply voltage		• of the address area of the outputs as DP master overall	30 256 byte
• 1 from backplane bus	3.3 V	• of the address area of the inputs per DP slave	244 byte
• 2 from the backplane bus	12 V	• of the address area of the outputs per DP slave	244 byte
Relative symmetrical tolerance		• of the address area of the diagnostic data per DP slave	244 byte
• at 3.3 V with DC	9 %	Software for DP slave function required	No
• at 12 V with DC	8 %	Service as DP slave	
Consumed current		• DPV0	Yes
• 1 from backplane bus with DC maximum	0.15 A	• DPV1	Yes
• 2 from backplane bus with DC maximum	0.25 A	Amount of data	
Resistive loss	3.5 W	• of the address area of the inputs as DP slave overall	244 byte
Permitted ambient conditions		• of the address area of the outputs as DP slave overall	244 byte
Ambient temperature		<u>Performance data</u> <u>S7 communication</u>	
• during operating	5 ... 55 °C	Software for S7 communication required	Yes, HARDNET-PB S7 (S7-5613)
• during storage	-20 ... +60 °C	Number of possible connections for S7/PG communication maximum	50
• during transport	-20 ... +60 °C	<u>Performance data</u> <u>multi-protocol mode</u>	
Relative humidity at 25 °C without condensation during operating maximum	85 %	Number of active connections with multiprotocol mode	50
Protection class IP	IP00	Number of configurable connections per PC station	207
Design, dimensions and weight		Product functions management, configuration	included in scope of delivery
Module format	PCI	Configuration software required	
Width	0.018 m	Product functions Diagnosis	
Height	0.107 m	Product function Port diagnostics	Yes
Depth	0.125 m	Standards, specifications, approvals	
Net weight	0.098 kg	Standard	
Product properties, functions, components general		• for EMC	89/336/EEC
Number of plug-in cards in the same design can be plugged in per PC station	4	• for safety of CSA and UL	CAN/CSA C22.2 & UL 60950-1, UL 1950
Number of modules note	-	• for emitted interference	EN 61000-6-3
Performance data		• for interference immunity	EN 61000-6-2
<u>Performance data</u> <u>open communication</u>		Verification of suitability	
Software for open communication by means of SEND/RECEIVE required	FDL driver included in scope of delivery of the CP	• CE mark	Yes
Number of possible connections for open communication by means of SEND/RECEIVE maximum	80	• C-Tick	Yes

PROFIBUS

Communication for PC-based systems

CP 5613 A3**Ordering data****Article No.****CP 5613 A3
communications processor****6GK1561-3AA02**

PCI card (32-bit; 3.3 V/5 V) for connection to PROFIBUS incl. DP-Base software; DP-RAM interface for DP master, incl. PG and FDL protocols; single license for one installation, runtime software, software and electronic manual on CD-ROM, Class A, for operating system support see SIMATIC NET software V12
English/German

Accessories**PROFIBUS FastConnect
bus connector RS 485 Plug 180****6GK1500-0FC10**

with 180° cable outlet,
insulation displacement

PROFIBUS FC Standard Cable GP**6XV1830-0EH10**

Standard type with special design for quick assembly, 2-core, shielded
Sold in meters

Delivery unit max. 1 000 m
Minimum order 20 m

PROFIBUS bus terminal 12M**6GK1500-0AA10**

Bus terminal for connection of PROFIBUS stations up to 12 Mbit/s with plug-in cable 1.5 m long

**PROFIBUS FastConnect
Stripping Tool****6GK1905-6AA00**

Preset stripping tool for fast stripping of PROFIBUS FastConnect bus cables

More information

You can find the HARDNET-PB DP Development Kit on the Internet at:

<http://www.siemens.com/simatic-net/dk5613>

The CP 5613 A3 module can also be used under the LINUX and UNIX operating systems. Information on the available LINUX distributors and UNIX operating systems can be found at:

<http://www.siemens.com/simatic-net/ik-info>

Note:

For software ordering data, see page 3/227

Overview



DP-M	DP-S	FMS	OPC	PG/OP	S7/S5
●	●		●	●	●

- PCI card (universal keyed 5 V/3.3 V) with own microprocessor for connection of PCs and SIMATIC PG/PC to PROFIBUS at up to 12 Mbit/s
- Communication services:
 - PROFIBUS DP master and slave interface according to IEC 61158/61784 on one PCI card
 - PG/OP communication with STEP 5 and STEP 7
 - S7 communication with HARDNET-PB S7 software package
 - Open communication (SEND/RECEIVE) based on the FDL interface
- Comprehensive diagnostics possibilities for installation, commissioning and operation of the module
- High performance over direct dual-port RAM access
- Event and filter mechanisms to reduce the loading on the host CPU
- Multiprotocol operation and parallel operation of up to four CPs
- Implementation of Motion Control applications is possible because a constant bus cycle time is supported
- The appropriate OPC servers and configuration tools are included in the scope of supply of the respective communications software.

Benefits

get **Designed for Industry**

- Fast access to process data by means of direct access to the dual port RAM of the hardware
- High computing performance in the PG/PC; reduces workload of host CPU by preprocessing the communication on the hardware
- Use of different operating system environments; driver as source code for porting to different operating system environments
- Reduced number of slots; through parallel operation as DP master and DP slave
- Can also be used in typical motion control applications
- Real-time capable data exchange in constant bus cycle time mode

Application



The CP 5614 A3 supports the connection of a SIMATIC PG/PC and PCs with PCI slot to PROFIBUS. It can be either a DP master or a DP slave.

Two different PROFIBUS networks can then be connected in a hierarchic structure on a PC with a PROFIBUS card and data can be transferred between the two.

The CP 5614 A3 provides high-performance support for control tasks on the PC (PC based Control, Numeric Control, Robot Control).

Design

- Short PCI card
- Operation possible in 3.3 V and 5 V PCI slots (universal keyed)
- 33 MHz or 66 MHz PCI clock
- Operation possible as 32-bit card in a 64-bit PCI X-slot
- 2 x 9-pin sub-D socket for connection to PROFIBUS
- Diagnostics LEDs
- Parallel operation of up to four CPs

The module is installed by means of PCI standard mechanisms (Plug&Play).

If the CP 5614 A3 is used as DP master, DP slave, or in a PG/OP on a PROFIBUS DP, the connection is made:

- **to the electrical PROFIBUS** via
 - Bus connector and PROFIBUS bus cable or
 - bus terminal (e.g. bus terminal 12M) and PROFIBUS bus cable
- **to the optical PROFIBUS with OLM** via
 - bus cable with two bus connectors or
 - PROFIBUS plug-in cable 830-1T
- **to the optical PROFIBUS with OBT and integrated interface** via
 - bus cable with two bus connectors or
 - PROFIBUS plug-in cable 830-1T

PROFIBUS

Communication for PC-based systems

CP 5614 A3

Function

PROFIBUS DP

Access to process data

The CP 5614 A3 is operated as a PROFIBUS DP master and DP slave module that stores the process image (input/output and diagnostic data) in the dual-port RAM. High-performance data transfer to and from the PROFIBUS slaves is performed autonomously by the hardware of the CP 5614 A3. The user accesses the dual-port RAM directly.

The process data of the slaves is always consistent, i.e. the user receives the data of a slave from one and the same DP cycle.

Parallel operation of the HARDNET-PB DP software (DP master) and DP-Base software (DP master, DP slave) is not possible.

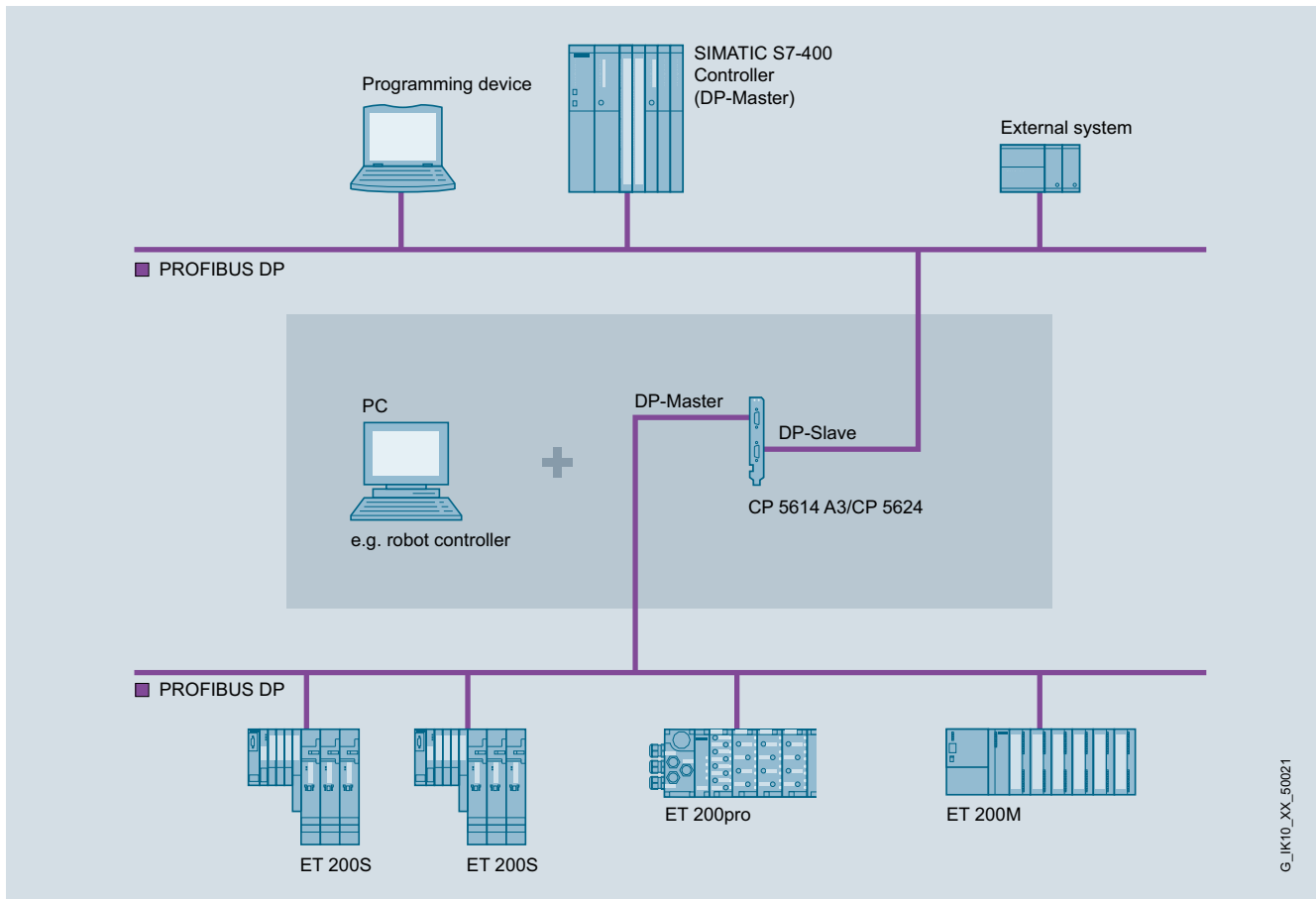

Example configuration of CP 5614 A3 as DP master and DP slave

Event filter mechanism

The user receives up-to-date data over two access mechanisms:

- Cyclic polling of the DP slaves (high loading for host CPU)
- Notification through event/filter mode on changing the input data of a slave (minimal loading for host CPU)

Both alternatives can be combined. This allows users to optimize use of the PC for their applications.

The event/filter mechanism can be used additionally for

- Notification by means of an interrupt of the diagnostic alarms from slaves
- During operation with constant bus cycle time, signaling by means of interrupt:
 - Start DP cycle
 - End cyclic data communication with DP slaves

FastLogic

FastLogic means that the CP 5614 A3 can react autonomously to 4 plant statuses. This results in a short response time and independence from the host application, e.g. fast shutdown of devices.

DP programming interface

The DP master programming interfaces of the CP 5613 A3 and CP 5614 A3 are identical.

The DP programming interface of the CP 5614 A3 features the following functions:

- DP slave
- DP master Class 1 including acyclic DP expansions
- DP master Class 2 including acyclic DP expansions

The process data is accessed directly through the dual-port RAM. The DP RAM interface not only offers fast access as DP master/slave but also a basis for porting to other operating system environments (e.g. VXWorks, QNX, RMOS, RTX).

Function (continued)

Administrative function calls (initialization and management services as well as diagnostic functions) are provided through a DP master and DP slave library (DP_BASE.DLL and DPS_BASE.DLL).

A transfer mechanism (PC application) can be activated in the software as a linking component for data transfer between the master and slave interface.

Defined I/O data can be transferred in this manner between the master interface and the slave interface.

The two connected PROFIBUS networks can be operated with different PROFIBUS bus parameters because they are independent of each other.

HARDNET-PB DP Development Kit

The HARDNET-PB DP Development Kit provides access to the functions DP master Class 1 and DP slave (incl. acyclic DP expansions)

The HARDNET-PB DP Development Kit is used to integrate the CP 5613 A3 and CP 5614 A3 communications processors into any operating system environment. The kit contains the necessary source code, including the descriptions in PDF format, and can be downloaded free of charge from the Internet.

Access to process data with HARDNET-PB DP

HARDNET-PB DP is available to permit compatibility with older applications that were created with the DP-Lib interface.

Parallel operation of the DP-Base and HARDNET-PB DP software is not possible.

Software for PG/OP communication

This software supports programming of the SIMATIC S7 controllers over PROFIBUS in combination with STEP 7. PG/OP communication is already available after the CP 5614 A3 (DP-Base) has been installed. No additional software packages are required.

Open communication (SEND/RECEIVE) based on the FDL interface

SEND/RECEIVE (FDL interface) is already available following installation of the CP 5614 A3 (DP-Base) and provides services for data transfer, diagnostics and management. No additional software packages are required.

Software for S7 communication (HARDNET-PB S7)

SIMATIC S7 system components communicate with each other using S7 communication functions. The S7 programming interface provides programming device/PC user programs with access to SIMATIC S7 system components. This provides easy, flexible access to the data of the SIMATIC S7 controller.

The following services are available with S7 communication:

Administrative services

- Connection management
- Mini database
- Trace

Data transfer services

- Read/write variables
- BSEND/BRECEIVE (up to 64 KB per task)

User interfaces

- **OPC interface**

The OPC server included in the respective software package can be used as the standard programming interface for the PROFIBUS DP (DP master and DP slave), open communication, S7 communication and PROFIBUS FMS protocols for linking automation technology applications to OPC-capable Windows applications (Office, HMI systems, etc.).

Configuration

- The S7 communication, open communication, DP protocol (DP-V0/DP-V1/DP-V2) protocols are configured in STEP 7 or NCM PC.
- A configuration tool is included in the scope of delivery of the PROFIBUS software packages.

Diagnostics

Comprehensive diagnostic tools are available (for installation, start-up and operation) for the module itself and for the PROFIBUS DP network. These tools can be used for quick and easy start-up of a PROFIBUS DP network with a CP 5614 A3.

PROFIBUS

Communication for PC-based systems

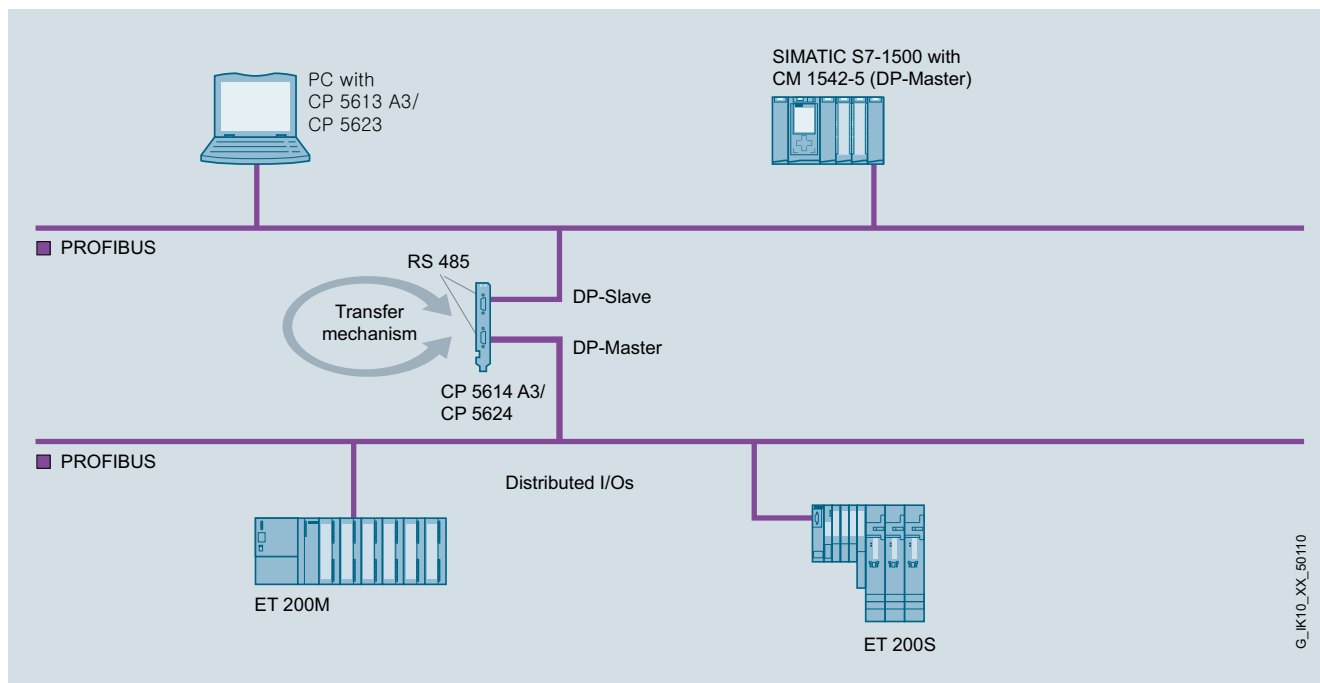
CP 5614 A3**Function** (continued)

Configuration example for CP 5614 A3

Technical specifications

Article No.	6GK1561-4AA02
Product-type designation	CP 5614 A3
Transmission rate	
Transmission rate	
• at interface 1 in accordance with PROFIBUS	9.6 kbit/s ... 12 Mbit/s
• at interface 2 in accordance with PROFIBUS	9.6 kbit/s ... 12 Mbit/s
Interfaces	
Number of electrical connections	
• at interface 1 in accordance with PROFIBUS	1
• at interface 2 in accordance with PROFIBUS	1
Design of electrical connection	
• at interface 1 in accordance with PROFIBUS	9-pin Sub-D socket (RS 485)
• at interface 2 in accordance with PROFIBUS	9-pin Sub-D socket (RS 485)
• of the backplane bus	
Supply voltage, current consumption, power loss	
Type of supply voltage	DC
Supply voltage	
• 1 from backplane bus	3.3 V
• 2 from the backplane bus	12 V
Relative symmetrical tolerance	
• at 3.3 V with DC	9 %
• at 12 V with DC	8 %
Consumed current	
• 1 from backplane bus with DC maximum	0.15 A
• 2 from backplane bus with DC maximum	0.3 A
Resistive loss	4 W

Article No.	6GK1561-4AA02
Product-type designation	CP 5614 A3
Permitted ambient conditions	
Ambient temperature	
• during operating	5 ... 55 °C
• during storage	-20 ... +60 °C
• during transport	-20 ... +60 °C
Relative humidity at 25 °C without condensation during operating maximum	85 %
Protection class IP	IP00
Design, dimensions and weight	
Module format	PCI
Width	18 mm
Height	107 mm
Depth	125 mm
Net weight	0.118 kg
Product properties, functions, components general	
Number of plug-in cards in the same design can be plugged in per PC station	4
Number of modules note	-
Performance data	
<u>Performance data open communication</u>	
Software for open communication by means of SEND/RECEIVE required	FDL driver included in scope of delivery of the CP
Number of possible connections for open communication by means of SEND/RECEIVE maximum	80

Technical specifications (continued)

Article No.	6GK1561-4AA02
Product-type designation	CP 5614 A3
<u>Performance data</u> <u>PROFIBUS DP</u>	
Software for DP master function required	No
Service as DP master	
• DPV0	Yes
• DPV1	Yes
• DPV2	Yes
Number of DP slaves on DP master usable	124
Amount of data	
• of the address area of the inputs as DP master overall	30 256 byte
• of the address area of the outputs as DP master overall	30 256 byte
• of the address area of the inputs per DP slave	244 byte
• of the address area of the outputs per DP slave	244 byte
• of the address area of the diagnostic data per DP slave	244 byte
Software for DP slave function required	No
Service as DP slave	
• DPV0	Yes
• DPV1	Yes
Amount of data	
• of the address area of the inputs as DP slave overall	244 byte
• of the address area of the outputs as DP slave overall	244 byte
<u>Performance data</u> <u>S7 communication</u>	
Software for S7 communication required	Yes, HARDNET-PB S7 (S7-5613)
Number of possible connections for S7/PG communication maximum	50
<u>Performance data</u> <u>multi-protocol mode</u>	
Number of active connections with multiprotocol mode	50
Number of configurable connections per PC station	207
Product functions management, configuration	
Configuration software required	included in scope of delivery
Product functions Diagnosis	
Product function Port diagnostics	Yes
Standards, specifications, approvals	
Standard	
• for EMC	89/336/EEC
• for safety of CSA and UL	CAN/CSA C22.2 & UL 60950-1, UL 1950
• for emitted interference	EN 61000-6-3
• for interference immunity	EN 61000-6-2
Verification of suitability	
• CE mark	Yes
• C-Tick	Yes

Ordering data

Article No.

CP 5614 A3 communications processor	6GK1561-4AA02
PCI card (32-bit; 3.3 V/5 V) master and slave connection to PROFIBUS incl. DP-Base software; DP-RAM interface for DP master, incl. PG and FDL protocols; single license for one installation, runtime software, software and electronic manual on CD-ROM, Class A, for operating system support see SIMATIC NET software V12; German/English	
<i>Accessories</i>	
PROFIBUS FastConnect bus connector RS 485 Plug 180	6GK1500-0FC10
with 180° cable outlet, insulation displacement	
PROFIBUS FC Standard Cable GP	6XV1830-0EH10
Standard type with special design for fast mounting, 2-core, shielded Sold by the meter max. delivery unit 1 000 m minimum order quantity 20 m	
PROFIBUS FastConnect Stripping Tool	6GK1905-6AA00
Preset stripping tool for fast stripping of PROFIBUS FastConnect bus cables	
PROFIBUS bus terminal 12M	6GK1500-0AA10
Bus terminal for connection of PROFIBUS stations up to 12 Mbit/s with plug-in cable 1.5 m long	

Note:

For software ordering data, see page 3/227

More information

You can find the HARDNET-PB DP Development Kit on the Internet at:

<http://www.siemens.com/simatic-net/dk5613>

The CP 5614 A3 module can also be used under the LINUX and UNIX operating systems. Information on the available LINUX distributors and UNIX operating systems can be found at:

<http://www.siemens.com/simatic-net/ik-info>

PROFIBUS

Communication for PC-based systems

CP 5623

Overview



DP-M	DP-S	FMS	OPC	PG/OP	S7/S5
●	●	●	●	●	●

- PCI Express card (PCIe x1) with own microprocessor for connecting PCs and SIMATIC PG/PC to PROFIBUS at up to 12 Mbit/s
- Communication services:
 - PROFIBUS DP master Class 1 and 2 or DP slave according to IEC 61158/61784 on a PCI card
 - PG/OP communication with STEP 5 and STEP 7
 - S7 communication with HARDNET-PB S7 software package
 - Open communication (SEND/RECEIVE) based on the FDL interface
 - PROFIBUS FMS according to IEC 61158/61784 with FMS-5613 software package
- Extensive diagnostics options for installation, commissioning and operation of the module
- Event and filter mechanism for reducing the load on the host CPU
- Multiprotocol operation and parallel operation of up to four CPs
- The appropriate OPC servers and configuration tools are included in the scope of supply of the respective communication software

Benefits

get **Designed for Industry**

- Fast access to process data by means of direct access to the dual port RAM of the hardware
- High computing performance in the PG/PC; reduces workload of host CPU by preprocessing the communication on the hardware
- Use of different operating system environments; driver as source code for porting to different operating system environments
- Preventive maintenance measures; deriving of measures by evaluating system runtime and ambient temperature
- Use also in motion control applications; real-time capable data exchange through constant bus cycle time

Application



The CP 5623 supports the connection of SIMATIC PG/PC and PCs with PCI Express slot to PROFIBUS.

The CP 5623 provides high-performance support for control tasks on the PC (PC based Control, Numeric Control, Robot Control).

Design

- Short PCI Express card
- Can also be operated in PCI Express x4, x8 or x16 slots
- 9-pin sub-D socket for connection to PROFIBUS
- Diagnostic LEDs
- Parallel operation of up to four CPs¹⁾

The module is installed by means of PCI standard mechanisms (Plug&Play).

If the CP 5623 is used as DP master or in a PG/OP on a PROFIBUS DP, the connection is made:

- **to the electrical PROFIBUS** via
 - bus connector and PROFIBUS bus cable or
 - bus terminal (e.g. bus terminal 12M) and PROFIBUS bus cable
- **to the optical PROFIBUS with OLM** via
 - bus cable with two bus connectors or
 - PROFIBUS plug-in cable 830-1T
- **to the optical PROFIBUS with OBT and integrated interface** via
 - bus cable with two bus connectors or
 - PROFIBUS plug-in cable 830-1T

¹⁾ FMS-5613 supports up to two CP 5603/CP 5613 A2/5614 A2/CP 5623/CP 5624 processors

Function

PROFIBUS DP

Access to process data with DP-Base

The CP 5623 is operated as PROFIBUS DP master module that keeps the process image (input/output and diagnostics data) in the dual port RAM (memory area on the CP). The hardware of the CP 5623 independently executes the high-performance exchange of data with the PROFIBUS slaves. The user accesses the dual-port RAM directly.

The process data of the slaves is always consistent, i.e. the user receives the data of a slave from one and the same DP cycle.

Parallel operation of the HARDNET-PB DP and DP-Base software is not possible.

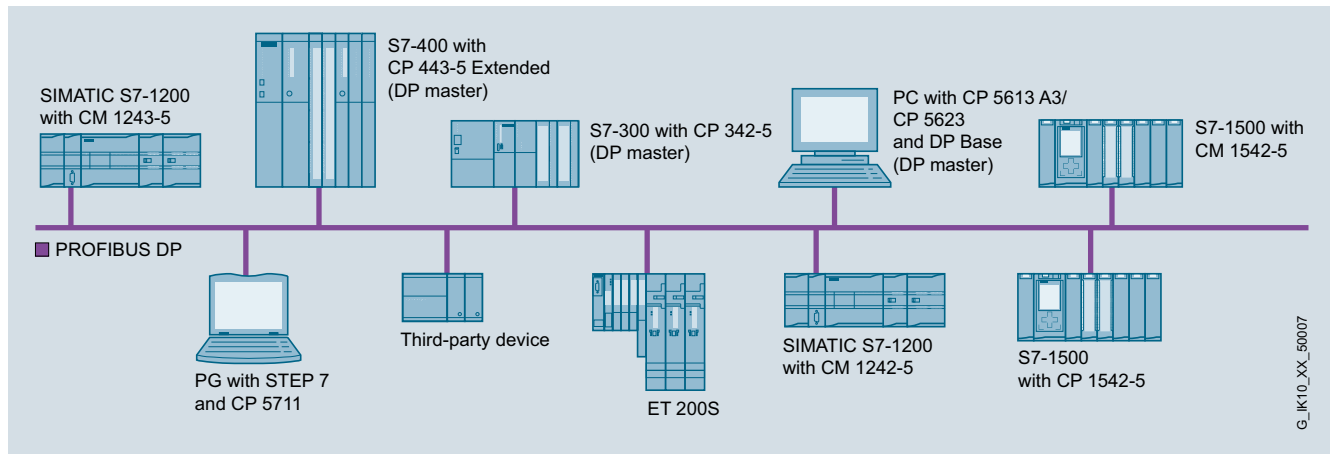

Example configuration of PROFIBUS DP for SIMATIC S5/S7 and PG/PC

Event filter mechanism

The user receives up-to-date data over two access mechanisms:

- Cyclic polling of the DP slaves (higher loading for host CPU)
- Notification by means of event/filter mode when changing the input data of a slave (minimal loading for host CPU)

Both alternatives can be combined. This allows users to optimize use of the PC for their applications.

The event/filter mechanism can be used additionally for

- Notification by means of an interrupt of the diagnostic messages from slaves
- During operation with constant bus cycle time, signaling by means of interrupt:
 - Start DP cycle
 - End of cyclic data exchange with DP slaves

FastLogic

FastLogic means that the CP 5623 can react autonomously to as many as four plant statuses. This results in a short response time and independence from the host application, e.g. fast shutdown of devices.

DP programming interface

The DP programming interface (DP-Base) of the CP 5623 has the following functionality:

- DP master class 1 including acyclic DP expansions
- DP master class 2 including acyclic DP expansions
- DP slave

The process data is accessed directly through the dual-port RAM. The DP RAM interface not only offers fast access as DP master/slave but also a basis for porting to other operating system environments (e.g. VXWorks, QNX, RMOS, RTX).

Administrative function calls (initialization and management services, as well as diagnostic functions) are provided through a library (DP_BASE.DLL or DPS_BASE.DLL).

HARDNET-PB DP Development Kit

The HARDNET-PB DP Development Kit provides access to the functions DP master Class 1 including acyclic DP expansions

The HARDNET-PB DP Development Kit software enables the CP 5623 communications processor to be integrated into any operating system environments. The kit contains the necessary source code, including the descriptions in PDF format, and can be downloaded free of charge from the Internet.

PROFIBUS

Communication for PC-based systems

CP 5623

Function (continued)

Access to process data with HARDNET-PB DP

HARDNET-PB DP is available to permit compatibility with older applications that were created with the DP-Lib interface.

Parallel operation of the DP-Base and HARDNET-PB DP software is not possible.

Software for PG/OP communication

This software supports programming of the SIMATIC S5/S7 controllers (with the exception of SIMATIC S5-95U) over PROFIBUS in combination with STEP 5/STEP 7. The PG/OP communication for the CP 5623 is already available following installation of the CP 5623 (DP-Base). No additional software packages are required.

Open communication (SEND/RECEIVE based on the FDL interface)

SEND/RECEIVE (FDL interface) is already available following installation of the CP 5623 (DP-Base) and provides services for data transfer, diagnostics and management. No additional software packages are required.

Software for S7 communication (HARDNET-PB S7)

SIMATIC S7 system components communicate with each other using S7 communication functions. The S7 programming interface provides programming device/PC user programs with access to SIMATIC S7 system components. This provides easy, flexible access to the data of the SIMATIC S7 controller.

The following services are available with S7 communication:

Administrative services

- Connection management
- Mini database
- Trace

Data transfer services

- Read/write variables
- BSEND/BRECEIVE (up to 64 KB per task)

Software for PROFIBUS FMS (FMS-5613)

With the FMS programming interface, PGs/PCs can exchange different manufacturer data with FMS-capable controllers (e.g. S5 and S7) and field devices. Open communication is assured by using the FMS interface.

The FMS interface offers the following services:

- Administrative services
- CRL management services
- FMS connection management services
- Object directory management services for clients and server
- Variable services for clients and servers (Read, Write, Information Report)
- Server functionality
- VFD services (Virtual Field Device) for clients and servers
- Bus access information services (live list)
- Trace and mini database

User interfaces

- **OPC interface**

The OPC server included in the respective software package can be used as the standard programming interface for the PROFIBUS DP, open communication, S7 communication and PROFIBUS FMS in order to connect automation technology applications to OPC-compatible Windows applications (Office, HMI systems, etc.)

- **Programming interface through C library**

The programming interfaces for existing applications are implemented as Dynamic Link Libraries (DLL). The released compilers can be found in the readme file of the SIMATIC NET CD products at <http://www.siemens.com/automation/csi/net>.

For Borland programming interfaces (e.g. DELPHI), partner solutions from SoftwareOption are offered.

For solutions for other operating systems, see HARDNET-PB DP Development Kit.

Configuration

- The S7 communication, open communication and DP-V0/DP-V1/DP-V2 protocols are configured in STEP 7 or NCM/PC.
- A configuration tool is included in the scope of delivery of the PROFIBUS software packages.

Diagnostics

Comprehensive diagnostic tools are available (for installation, start-up and operation) for the module itself and for the PROFIBUS DP network. These tools can be used for quick and easy start-up of a PROFIBUS network with a CP 5623.

Technical specifications

Article No.	6GK1562-3AA00
Product-type designation	CP 5623
Transmission rate	
Transmission rate at interface 1 in accordance with PROFIBUS	9.6 kbit/s ... 12 Mbit/s
Interfaces	
Number of electrical connections at interface 1 in accordance with PROFIBUS	1
Design of electrical connection	9-pin Sub-D socket (RS 485)
• at interface 1 in accordance with PROFIBUS	
• of the backplane bus	PCI Express x1
Supply voltage, current consumption, power loss	
Type of supply voltage	DC
Supply voltage	3.3 V
• 1 from backplane bus	12 V
• 2 from the backplane bus	
Relative symmetrical tolerance	9 %
• at 3.3 V with DC	8 %
• at 12 V with DC	
Consumed current	0.72 A
• 1 from backplane bus with DC maximum	
• 2 from backplane bus with DC maximum	0.25 A
Resistive loss	5.4 W
Permitted ambient conditions	
Ambient temperature	5 ... 60 °C
• during operating	-20 ... +60 °C
• during storage	
• during transport	-20 ... +60 °C
Relative humidity at 25 °C without condensation during operating maximum	85 %
Protection class IP	IP00
Design, dimensions and weight	
Module format	PCI Express x1 (half length)
Width	21.6 mm
Height	126.3 mm
Depth	180.5 mm
Net weight	102 g
Product properties, functions, components general	
Number of plug-in cards in the same design can be plugged in per PC station	4
Number of modules note	FMS-5613 supports up to two CP 5603 / CP 5613 A2 / CP 5614 A2 / CP 5623 / CP 5624 processors
Performance data	
<u>Performance data open communication</u>	
Software for open communication by means of SEND/RECEIVE required	FDL driver included in scope of delivery of the CP
Number of possible connections for open communication by means of SEND/RECEIVE maximum	80

Article No.	6GK1562-3AA00
Product-type designation	CP 5623
<u>Performance data PROFIBUS DP</u>	
Software for DP master function required	No
Service as DP master	
• DPV0	Yes
• DPV1	Yes
• DPV2	Yes
Number of DP slaves on DP master usable	124
Amount of data	
• of the address area of the inputs as DP master overall	30 256 byte
• of the address area of the outputs as DP master overall	30 256 byte
• of the address area of the inputs per DP slave	244 byte
• of the address area of the outputs per DP slave	244 byte
• of the address area of the diagnostic data per DP slave	244 byte
Software for DP slave function required	No
Service as DP slave	
• DPV0	Yes
• DPV1	Yes
Amount of data	
• of the address area of the inputs as DP slave overall	244 byte
• of the address area of the outputs as DP slave overall	244 byte
<u>Performance data FMS functions</u>	
Software for FMS communication required	Yes, FMS-5613
Number of possible connections for FMS connection maximum	40
<u>Performance data S7 communication</u>	
Software for S7 communication required	Yes, HARDNET-PB S7 (S7-5613)
Number of possible connections for S7/PG communication maximum	50
<u>Performance data multi-protocol mode</u>	
Number of active connections with multiprotocol mode	50
Number of configurable connections per PC station	207
Product functions management, configuration	
Configuration software required	included in scope of delivery
Product functions Diagnosis	
Product function Port diagnostics	Yes
Standards, specifications, approvals	
Standard	
• for EMC	2004/108/EC
• for safety of CSA and UL	CAN/CSA C22.2 & UL 60950-1
• for emitted interference	EN 61000-6-3, EN 61000-6-4
• for interference immunity	EN 61000-6-1, EN 61000-6-2
Verification of suitability	
• CE mark	Yes
• C-Tick	Yes

PROFIBUS

Communication for PC-based systems

CP 5623

Ordering data

Article No.

CP 5623**communications processor**

PCI Express x1 card (32 bit) for connection to PROFIBUS incl. DP-Base software with NCM PC; DP-RAM interface for DP master or DP slave, incl. PG and FDL protocols; single license for one installation, runtime software, software and electronic manual on CD-ROM, Class A, for operating system support see SIMATIC NET software German/English

6GK1562-3AA00**Software-Upgrade**

für CP 5603, CP 5613 A2 und CP 5623 auf Edition 2008 oder V8.1

6GK1561-3AA01-3AE0*Accessories***PROFIBUS FastConnect bus connector RS485 Plug 180**

with 180° cable outlet, insulation displacement

6GK1500-0FC10**PROFIBUS FC Standard Cable GP**

Standard type with special design for quick assembly, 2-core, shielded

Sold in meters
max. length 1 000 m
minimum order 20 m

6XV1830-0EH10**PROFIBUS FastConnect Stripping Tool**

Preset stripping tool for fast stripping of PROFIBUS FastConnect bus cables

6GK1905-6AA00**PROFIBUS bus terminal 12M**

Bus terminal for connection of PROFIBUS stations up to 12 Mbit/s with plug-in cable 1.5 m long

6GK1500-0AA10Note:

For software ordering data, see page 3/227

More information

You can find the HARDNET-PB DP Development Kit on the Internet at:

<http://www.siemens.com/simatic-net/dk5613>

The CP 5623 module can also be used under LINUX and UNIX operating systems. Information on the available LINUX distributors and UNIX operating systems can be found at:

www.siemens.com/simatic-net/ik-info

Overview



DP-M	DP-S	FMS	OPC	PG/OP	S7/S5
●	●	●	●	●	●

- PCI Express card (PCIe x1) with own microprocessor for connecting PCs and SIMATIC PG/PC to PROFIBUS at up to 12 Mbit/s
- Two 9-pin sub-D sockets for parallel operation as DP master and DP slave
- Communication services:
 - PROFIBUS DP master and slave interface according to IEC 61158/61784 on one PCI card
 - PG/OP communication with STEP 5 and STEP 7
 - S7 communication with HARDNET-PB S7 software package
 - Open communication (SEND/RECEIVE) based on the FDL interface
 - PROFIBUS FMS according to IEC 61158/61784 with FMS-5613 software package
- Extensive diagnostics options for installation, commissioning and operation of the module
- Event and filter mechanism for reducing the load on the host CPU
- Multiprotocol operation and parallel operation of up to four CPs
- The appropriate OPC servers and configuration tools are included in the scope of supply of the respective communication software

Benefits

get **Designed for Industry**

- Fast access to process data by means of direct access to the dual port RAM of the hardware
- High computing performance in the PG/PC; reduces workload of host CPU by preprocessing the communication on the hardware
- Use of different operating system environments; driver as source code for porting to different operating system environments
- Saving of slots through parallel operation as DP master and DP slave
- Preventive maintenance measures; deriving of measures by evaluating system runtime and ambient temperature
- Use also in motion control applications; real-time capable data exchange through constant bus cycle time204

Application



The CP 5624 supports the connection of SIMATIC PG/PC and PCs with PCI Express slot to PROFIBUS. It can be both DP master and DP slave.

This enables two different PROFIBUS networks to be connected in a hierarchical structure to a PC and to exchange data using one PROFIBUS card.

The CP 5624 provides high-performance support for control tasks on the PC (PC based Control, Numeric Control, Robot Control).

Design

- Short PCI Express card
- Can also be operated in PCI Express x4, x8 or x16 slots
- 2 x 9-pin sub-D socket for connection to PROFIBUS
- Diagnostic LEDs
- Parallel operation of as many as four CPs¹⁾

The module is installed by means of PCI standard mechanisms (Plug&Play).

If the CP 5624 is used as DP master, DP slave, or in a PG/OP on a PROFIBUS DP, the connection is made:

- **to the electrical PROFIBUS** via
 - bus connector and PROFIBUS bus cable or
 - bus terminal (e.g. bus terminal 12M) and PROFIBUS bus cable
- **to the optical PROFIBUS with OLM** via
 - bus cable with two bus connectors or
 - PROFIBUS plug-in cable 830-1T
- **to the optical PROFIBUS with OBT and integrated interface** via
 - bus cable with two bus connectors or
 - PROFIBUS plug-in cable 830-1T

¹⁾ FMS-5613 supports up to two CP 5603/CP 5613 A2/5614 A2/CP 5623/CP 5624 processors

PROFIBUS

Communication for PC-based systems

CP 5624

Function

PROFIBUS DP

Access to process data

The CP 5624 is operated as PROFIBUS DP master and DP slave module, which keeps the process image (input/output and diagnostic data) in the dual port RAM. The hardware of the CP 5624 independently executes the high-performance exchange of data with the PROFIBUS slaves. The user accesses the dual-port RAM directly.

The process data of the slaves is always consistent, i.e. the user receives the data of a slave from one and the same DP cycle.

Parallel operation of the HARDNET-PB DP software (DP master) and DP-Base software (DP master, DP slave) is not possible.

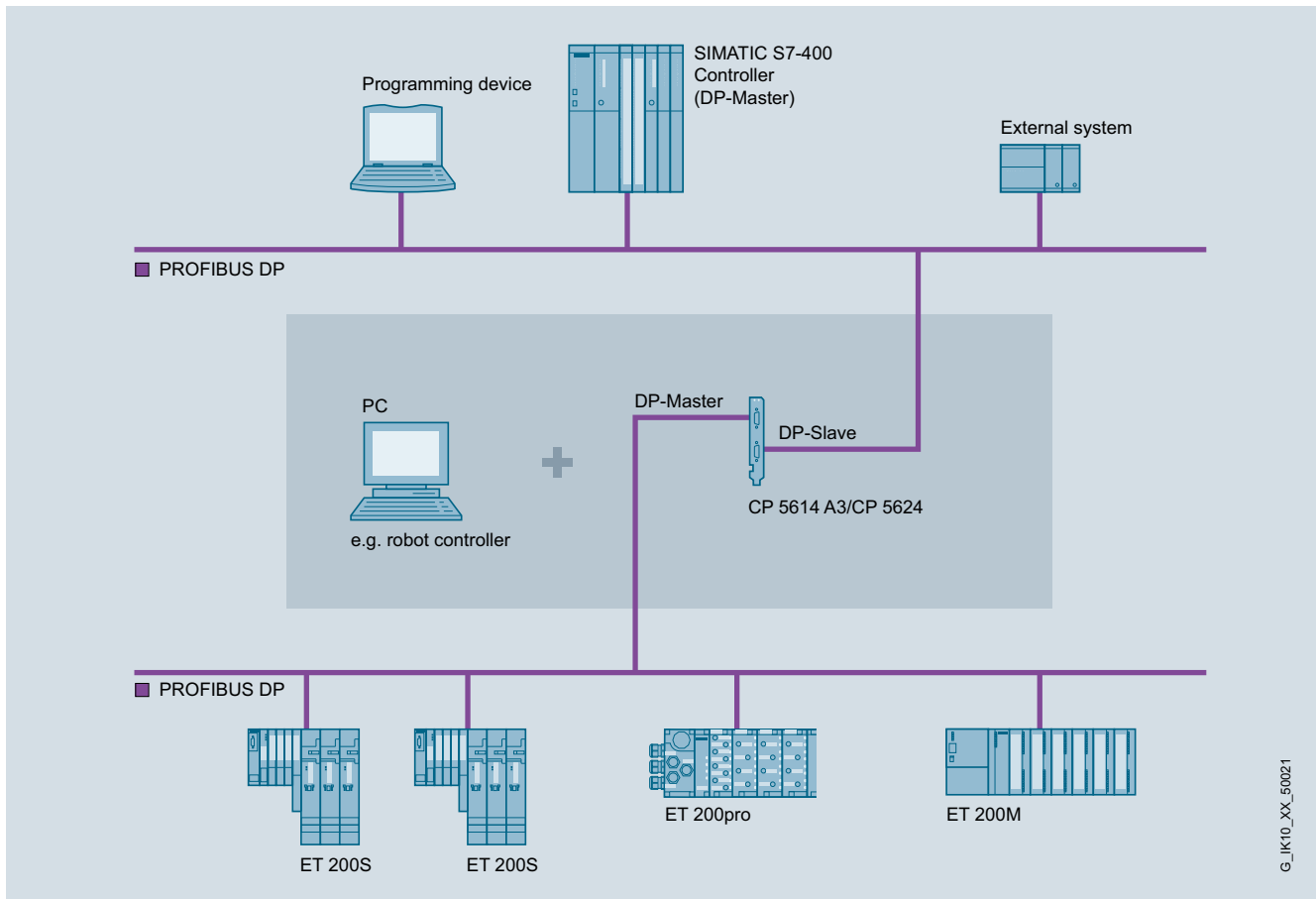

Example configuration of CP 5624 as DP master and DP slave

Event filter mechanism

The user receives up-to-date data over two access mechanisms:

- Cyclic polling of the DP slaves (high loading for host CPU)
- Notification through a new type of event/filter mode on changing the input data of a slave (minimal loading for host CPU)

Both alternatives can be combined. This allows users to optimize use of the PC for their applications.

The event/filter mechanism can be used additionally for

- Notification by means of an interrupt of the diagnostic messages from slaves
- During operation with constant bus cycle time, signaling by means of interrupt:
 - Start DP cycle
 - End cyclic data communication with DP slaves

FastLogic

FastLogic means that the CP 5624 can react autonomously to as many as four plant statuses. This results in a short response time and independence from the host application, e.g. fast shutdown of devices.

DP programming interface

The DP programming interface of the CP 5624 has the following functionality:

- DP slave
- DP master Class 1 including acyclic DP expansions
- DP master Class 2 including acyclic DP expansions

The process data is accessed directly through the dual-port RAM. The DP RAM interface not only offers fast access as DP master/slave but also a basis for porting to other operating system environments (e.g. VXWorks, QNX, RMOS, RTX).

Function (continued)

Administrative function calls (initialization and management services as well as diagnostic functions) are provided through a DP master and DP slave library (DP_BASE.DLL and DPS_BASE.DLL).

A transfer mechanism (PC application) can be activated in the software as a linking component for data transfer between the master and slave interface.

Defined I/O data can be transferred in this manner between the master interface and the slave interface.

The two connected PROFIBUS networks can be operated with different PROFIBUS bus parameters because they are independent of each other.

HARDNET-PB DP Development Kit

The HARDNET-PB DP Development Kit provides access to the functions DP master Class 1 and DP slave (incl. acyclic DP expansions)

The HARDNET-PB DP Development Kit software enables the CP 5624 communications processor to be integrated into any operating system environments. The kit contains the necessary source code, including the descriptions in PDF format, and can be downloaded free of charge via the Internet.

Access to process data with HARDNET-PB DP

HARDNET-PB DP is available to permit compatibility with older applications that were created with the DP-Lib interface.

Parallel operation of the DP-Base and HARDNET-PB DP software is not possible.

Software for PG/OP communication

This software supports programming of the SIMATIC S5/S7 controllers (with the exception of SIMATIC S5-95U) over PROFIBUS in combination with STEP 5/STEP 7. The PG/OP communication for the CP 5624 is already available following installation of the CP 5624 (DP-Base). No additional software packages are required.

Open communication (SEND/RECEIVE based on the FDL interface)

SEND/RECEIVE (FDL interface) is already available following installation of the CP 5624 (DP-Base) and provides services for data transfer, diagnostics and management. No additional software packages are required.

Software for S7 communication (HARDNET-PB S7)

SIMATIC S7 system components communicate with each other using S7 communication functions. The S7 programming interface provides programming device/PC user programs with access to SIMATIC S7 system components. This provides easy, flexible access to the data of the SIMATIC S7 controller.

The following services are available with S7 communication:

Administrative services

- Connection management
- Mini database
- Trace

Data transfer services

- Read/write variables
- BSEND/BRECEIVE (up to 64 KB per task)

Software for PROFIBUS FMS (FMS-5613)

With the FMS programming interface, PGs/PCs can exchange different manufacturer data with FMS-capable controllers (e.g. S5 and S7) and field devices. Open communication is assured by using the FMS interface.

The FMS interface offers the following services:

- Administrative services
- CRL management services
- FMS connection management services
- Object directory management services for clients and server
- Variable services for clients and servers (Read, Write, Information Report)
- Server functionality
- VFD services (Virtual Field Device) for clients and servers
- Bus access information services (live list)
- Trace and mini database

User interfaces

- **OPC interface**

The OPC server included in the respective software package can be used as the standard programming interface for the PROFIBUS DP (DP master and DP slave), open communication, S7 communication and PROFIBUS FMS in order to connect automation technology applications to OPC-compatible Windows applications (Office, HMI systems, etc.).

- **Programming interface through C library**

The programming interfaces for existing applications are implemented as Dynamic Link Libraries (DLL). The released compilers can be found in the readme file of the SIMATIC NET CD products at <http://www.siemens.com/automation/csi/net>.

For Borland programming interfaces (e.g. DELPHI), partner solutions from SoftwareOption are offered.

For solutions for other operating systems, see HARDNET-PB DP Development Kit.

Configuration

- The S7 communication, open communication and DP-V0/DP-V1/DP-V2 protocols are configured in STEP 7 or NCM PC.
- A configuration tool is included in the scope of delivery of the PROFIBUS software packages.

Diagnostics

Comprehensive diagnostic tools are available (for installation, start-up and operation) for the module itself and for the PROFIBUS DP network. These tools can be used for quick and easy start-up of a PROFIBUS DP network with a CP 5624.

PROFIBUS

Communication for PC-based systems

CP 5624

Function (continued)

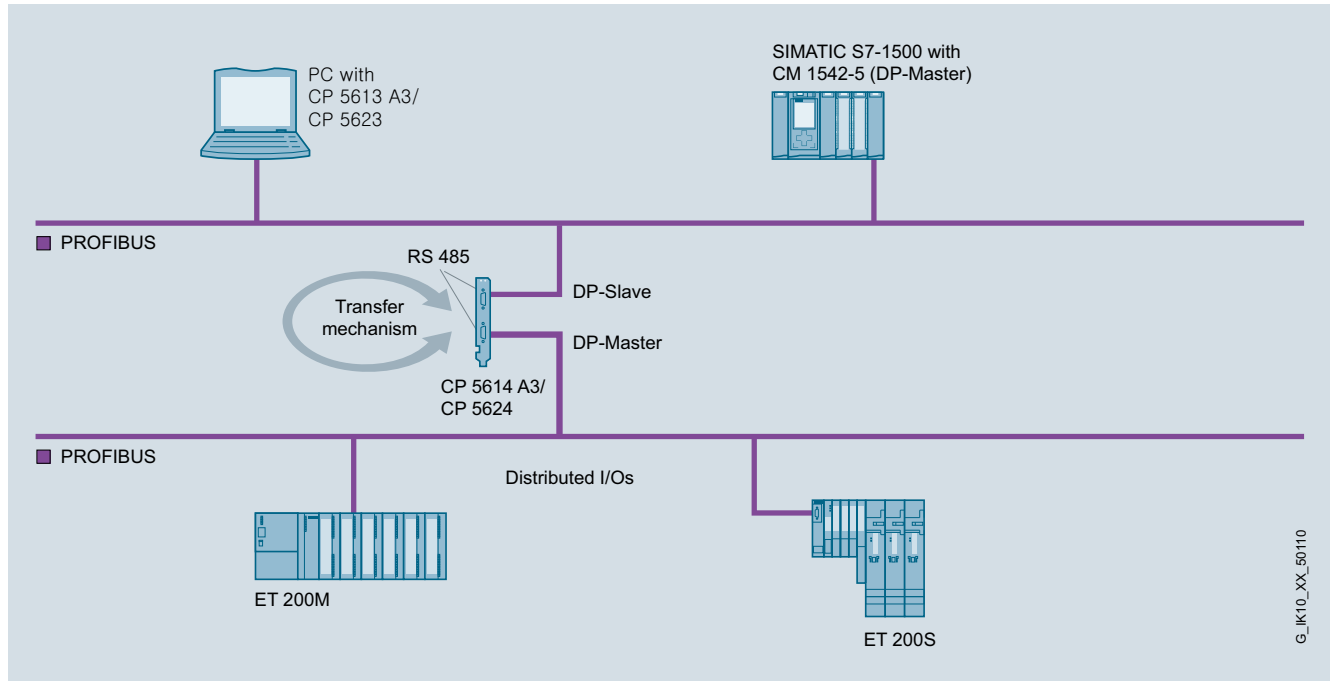

Configuration example for CP 5624

Technical specifications

Article No.	6GK1562-4AA00
Product-type designation	CP 5624
Transmission rate	
Transmission rate	
• at interface 1 in accordance with PROFIBUS	9.6 kbit/s ... 12 Mbit/s
• at interface 2 in accordance with PROFIBUS	9.6 kbit/s ... 12 Mbit/s
Interfaces	
Number of electrical connections	
• at interface 1 in accordance with PROFIBUS	1
• at interface 2 in accordance with PROFIBUS	1
Design of electrical connection	
• at interface 1 in accordance with PROFIBUS	9-pin Sub-D socket (RS 485)
• at interface 2 in accordance with PROFIBUS	9-pin Sub-D socket (RS 485)
• of the backplane bus	PCI Express x1
Supply voltage, current consumption, power loss	
Type of supply voltage	DC
Supply voltage	
• 1 from backplane bus	3.3 V
• 2 from the backplane bus	12 V
Relative symmetrical tolerance	
• at 3.3 V with DC	9 %
• at 12 V with DC	8 %
Consumed current	
• 1 from backplane bus with DC maximum	0.75 A
• 2 from backplane bus with DC maximum	0.3 A
Resistive loss	6.1 W

Article No.	6GK1562-4AA00
Product-type designation	CP 5624
Permitted ambient conditions	
Ambient temperature	
• during operating	5 ... 60 °C
• during storage	-20 ... +60 °C
• during transport	-20 ... +60 °C
Relative humidity at 25 °C without condensation during operating maximum	85 %
Protection class IP	IP00
Design, dimensions and weight	
Module format	PCI Express x1 (half length)
Width	21.6 mm
Height	126.3 mm
Depth	180.5 mm
Net weight	117 g
Product properties, functions, components general	
Number of plug-in cards in the same design can be plugged in per PC station	4
Number of modules note	FMS-5613 supports up to two CP 5603 / CP 5613 A2 / CP 5614 A2 / CP 5623 / CP 5624 processors
Performance data	
<u>Performance data open communication</u>	
Software for open communication by means of SEND/RECEIVE required	FDL driver included in scope of delivery of the CP
Number of possible connections for open communication by means of SEND/RECEIVE maximum	80

G_IK10_XX_50110

Technical specifications (continued)

Article No.	6GK1562-4AA00
Product-type designation	CP 5624
<u>Performance data</u> <u>PROFIBUS DP</u>	
Software for DP master function required	No
Service as DP master	
• DPV0	Yes
• DPV1	Yes
• DPV2	Yes
Number of DP slaves on DP master usable	124
Amount of data	
• of the address area of the inputs as DP master overall	30 256 byte
• of the address area of the outputs as DP master overall	30 256 byte
• of the address area of the inputs per DP slave	244 byte
• of the address area of the outputs per DP slave	244 byte
• of the address area of the diagnostic data per DP slave	244 byte
Software for DP slave function required	No
Service as DP slave	
• DPV0	Yes
• DPV1	Yes
Amount of data	
• of the address area of the inputs as DP slave overall	244 byte
• of the address area of the outputs as DP slave overall	244 byte
<u>Performance data</u> <u>FMS functions</u>	
Software for FMS communication required	Yes, FMS-5613
Number of possible connections for FMS connection maximum	40
<u>Performance data</u> <u>S7 communication</u>	
Software for S7 communication required	Yes, HARDNET-PB S7 (S7-5613)
Number of possible connections for S7/PG communication maximum	50
<u>Performance data</u> <u>multi-protocol mode</u>	
Number of active connections with multiprotocol mode	50
Number of configurable connections per PC station	207
Product functions management, configuration	
Configuration software required	included in scope of delivery
Product functions Diagnosis	
Product function Port diagnostics	Yes
Standards, specifications, approvals	
Standard	
• for EMC	2004/108/EC
• for safety of CSA and UL	CAN/CSA C22.2 & UL 60950-1
• for emitted interference	EN 61000-6-3, EN 61000-6-4
• for interference immunity	EN 61000-6-1, EN 61000-6-2
Verification of suitability	
• CE mark	Yes
• C-Tick	Yes

Ordering data

Article No.

CP 5624 communications processor	6GK1562-4AA00
PCI Express x1 card (32 bit) for master and slave connection to PROFIBUS incl. DP-Base software with NCM PC; DP-RAM interface for DP master, incl. PG and FDL protocols; single license for one installation, runtime software, software and electronic manual on CD-ROM, Class A, for operating system support see SIMATIC NET software; German/English	
<i>Accessories</i>	
PROFIBUS FastConnect bus connector RS485 Plug 180	6GK1500-0FC10
With 180° cable outlet, insulation displacement	
PROFIBUS FC Standard Cable GP	6XV1830-0EH10
Standard type with special design for quick assembly, 2-core, shielded, sold in meters; max. length 1 000 m, minimum order 20 m	
PROFIBUS FastConnect Stripping Tool	6GK1905-6AA00
Preset stripping tool for fast stripping of PROFIBUS FastConnect bus cables	
PROFIBUS bus terminal 12M	6GK1500-0AA10
Bus terminal for connection of PROFIBUS stations up to 12 Mbit/s with plug-in cable 1.5 m long	

Note:

For software ordering data, see page 3/227

More information

You can find the HARDNET-PB DP Development Kit on the Internet at:

<http://www.siemens.com/simatic-net/dk5613>

PROFIBUS

Communication for PC-based systems

CP 5612

Overview



DP-M	DP-S	FMS	OPC	PG/OP	S7/S5
●	●		●	●	●

- PCI card (universal-keyed 5 V/3.3 V) for connecting PCs and SIMATIC PG/PC to PROFIBUS at up to 12 Mbit/s and to the MPI interface of SIMATIC S7
- Communication services:
 - PROFIBUS DP Master Class 1 incl. acyclic DP expansions with SOFTNET-PB DP software package
 - PROFIBUS DP Master Class 2 incl. acyclic DP expansions with SOFTNET-PB DP software package
 - PROFIBUS DP slave with SOFTNET-PB DP Slave software package
 - PG/OP communication with STEP 7
 - S7 communication with SOFTNET-PB S7 software package
 - Open communication (SEND/RECEIVE on basis of the FDL interface) with SOFTNET-PB DP or SOFTNET-PB S7 software package
- Can be used with:
 - STEP 7, STEP 7-Micro/Win, SIMATIC PDM (for PG/OP communication)
 - SOFTNET-PB S7 (for S7 communication)
 - SOFTNET-PB DP, SOFTNET-PB DP slave (for DP)
- The appropriate OPC servers and configuration tools are included in the scope of supply of the respective communications software.

Benefits

get **Designed for Industry**

- Connection for portable PCs (e.g. for diagnostics and commissioning)
- Easy installation and startup
- Optimally coordinated with SOFTNET
- OPC as standard interface
- Uniform procedure and configuration functionality with NCM PC and STEP 7
- Flexible use possible in PG/PC through PCI 3.3/5 V, 33/66 MHz and compatibility with 64-bit PCI X slot

Application



The CP 5612 permits the connection of programming devices (PGs) and PCs to PROFIBUS and to the multipoint interface (MPI) of the SIMATIC S7:

- for PGs/PCs with PCI slot

Design

- Short PCI card
- Operation possible in 3.3 V and 5 V PCI slots (universal keyed)
- 33 MHz or 66 MHz PCI clock
- Operation possible as 32-bit card in a 64-bit PCI X slot
- 9-pin sub-D socket for connection to PROFIBUS

Function

The CP 5612 is operated under various software packages and offers the user the opportunity of performing functions of the programming devices and PCs by means of PROFIBUS and the multipoint interface (MPI).

Only one CP can be used per PG or PC. Similarly only one protocol (PROFIBUS DP, S7 communication or FDL) can be used per CP.

The following software packages support the CP 5612:

- STEP 7 from V5.5 SP3;
Drivers for the CP 5612 are included with STEP 7.
- SOFTNET-S7 V8.2 SP1 and higher;
This package allows the S7 programming interface to be used.
- SOFTNET-DP V8.2 SP1 and higher;
This enables the CP 5612 to be used as PROFIBUS DP master Class 1 or Class 2.
- SOFTNET-DP Slave V8.2 SP1 and higher;
For use of the CP 5612 as PROFIBUS DP slave
- NCM PC;
Drivers for the CP 5612 are included in the scope of supply (SIMATIC NET CD V8.2 SP1 and higher).
- WinCC/WinCC Flexible;
Drivers for the CP 5612 are included in the scope of supply (SIMATIC NET CD V8.2 SP1 and higher).

Technical specifications

Article No.	6GK1561-2AA00	6GK1561-2AM00
Product-type designation	CP 5612	CP 5612 MPI
Transmission rate		
Transmission rate at interface 1 in accordance with PROFIBUS	9.6 kbit/s ... 12 Mbit/s	9.6 kbit/s ... 12 Mbit/s
Interfaces		
Number of electrical connections at interface 1 in accordance with PROFIBUS	1	1
Design of electrical connection <ul style="list-style-type: none"> • at interface 1 in accordance with PROFIBUS • of the backplane bus 	9-pin Sub-D socket (RS 485)	9-pin Sub-D socket (RS 485)
Supply voltage, current consumption, power loss		
Type of supply voltage	DC	DC
Supply voltage <ul style="list-style-type: none"> • 1 from backplane bus • 2 from the backplane bus 	3.3 V 12 V	3.3 V 12 V
Relative symmetrical tolerance <ul style="list-style-type: none"> • at 3.3 V with DC • at 12 V with DC 	9 % 8 %	9 % 8 %
Consumed current <ul style="list-style-type: none"> • 1 from backplane bus with DC maximum • 2 from backplane bus with DC maximum 	0.15 A 0.25 A	0.15 A 0.25 A
Resistive loss	3.5 W	3.5 W
Permitted ambient conditions		
Ambient temperature <ul style="list-style-type: none"> • during operating • during storage • during transport 	5 ... 55 °C -20 ... +60 °C -20 ... +60 °C	5 ... 55 °C -20 ... +60 °C -20 ... +60 °C
Relative humidity at 25 °C without condensation during operating maximum	95 %	95 %
Protection class IP	IP00	IP00
Design, dimensions and weight		
Module format	PCI	PCI
Width	18 mm	18 mm
Height	107 mm	107 mm
Depth	125 mm	125 mm
Net weight	98 g	298 g
Product properties, functions, components general		
Number of plug-in cards in the same design can be plugged in per PC station	1	1
Number of modules note	-	-

PROFIBUS

Communication for PC-based systems

CP 5612**Technical specifications** (continued)

Article No.	6GK1561-2AA00	6GK1561-2AM00
Product-type designation	CP 5612	CP 5612 MPI
Performance data		
<u>Performance data open communication</u>		
Software for open communication by means of SEND/RECEIVE required	Yes, SOFTNET-PB DP / SOFTNET-PB DP Slave / SOFTNET-PB S7	Yes, SOFTNET-PB DP / SOFTNET-PB DP Slave / SOFTNET-PB S7
Number of possible connections for open communication by means of SEND/RECEIVE maximum	50	50
<u>Performance data PROFIBUS DP</u>		
Software for DP master function required	Yes, SOFTNET-PB DP	Yes, SOFTNET-PB DP
Service as DP master		
• DPV0	Yes	Yes
• DPV1	Yes	Yes
• DPV2	No	No
Number of DP slaves on DP master usable	64	64
<u>Amount of data</u>		
• of the address area of the inputs as DP master overall	14 640 byte	14 640 byte
• of the address area of the outputs as DP master overall	14 640 byte	14 640 byte
• of the address area of the inputs per DP slave	244 byte	244 byte
• of the address area of the outputs per DP slave	244 byte	244 byte
• of the address area of the diagnostic data per DP slave	244 byte	244 byte
Software for DP slave function required	Yes, SOFTNET-PB DP slave	Yes, SOFTNET-PB DP slave
Service as DP slave		
• DPV0	Yes	Yes
• DPV1	No	No
<u>Amount of data</u>		
• of the address area of the inputs as DP slave overall	122 byte	122 byte
• of the address area of the outputs as DP slave overall	122 byte	122 byte
<u>Performance data S7 communication</u>		
Software for S7 communication required	Yes, SOFTNET-PB S7	Yes, SOFTNET-PB S7
Number of possible connections for S7/PG communication maximum	8	8
<u>Performance data multi-protocol mode</u>		
Number of configurable connections per PC station	207	207
Product functions management, configuration		
Configuration software required	included in scope of delivery of required software product	included in scope of delivery of required software product

Technical specifications (continued)

Article No.	6GK1561-2AA00	6GK1561-2AM00
Product-type designation	CP 5612	CP 5612 MPI
Standards, specifications, approvals		
Standard	89/336/EEC	89/336/EEC
• for EMC	CAN/CSA C22.2 & UL 60950-1, UL 1950	CAN/CSA C22.2 & UL 60950-1, UL 1950
• for safety of CSA and UL	EN 61000-6-3	EN 61000-6-3
• for emitted interference	EN 61000-6-2	EN 61000-6-2
• for interference immunity		
Verification of suitability		
• CE mark	Yes	Yes
• C-Tick	Yes	Yes
Accessories		
Accessories	optional: MPI cable	included in scope of supply: MPI cable

Ordering data
Article No.

CP 5612 communications processor	
• PCI card (32-bit) for connection of a programming device or PC to PROFIBUS	6GK1561-2AA00
• PCI card (32-bit) CP 5612 and MPI cable, 5 m	6GK1561-2AM00
Accessories	
PROFIBUS FastConnect bus connector RS485 Plug 180	6GK1500-0FC10
With 180° cable outlet, insulation displacement	
PROFIBUS FC Standard Cable GP	6XV1830-0EH10
Standard type with special design for quick assembly, 2-core, shielded, sold in meters; max. length 1 000 m, minimum order 20 m	
PROFIBUS FastConnect Stripping Tool	6GK1905-6AA00
Preset stripping tool for fast stripping of PROFIBUS FastConnect bus cables	
PROFIBUS bus terminal 12M	6GK1500-0AA10
Bus terminal for connection of PROFIBUS stations up to 12 Mbit/s with plug-in cable 1.5 m long	

Note:

For software ordering data, see page 3/227

PROFIBUS

Communication for PC-based systems

CP 5622

Overview

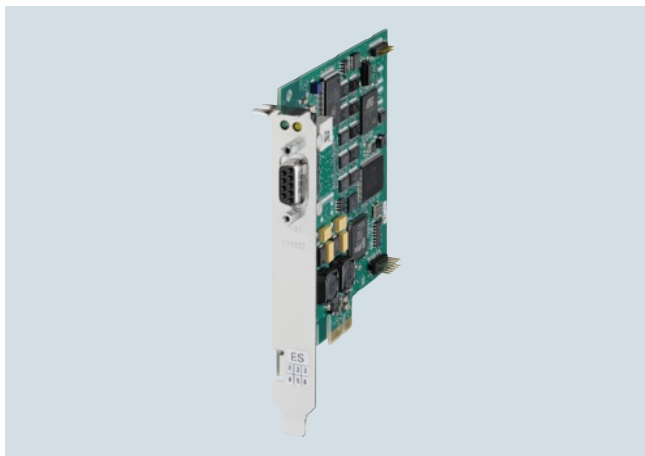

DP-M	DP-S	FMS	OPC	PG/OP	S7/S5
●	●		●	●	●

- PCI Express card (PCIe x1) for connection of PCs and SIMATIC PG/PC to PROFIBUS at up to 12 Mbit/s and to the MPI of the SIMATIC S7
- Communication services:
 - PROFIBUS DP Master Class 1 incl. acyclic DP expansions with SOFTNET-PB DP software package
 - PROFIBUS DP Master Class 2 incl. acyclic DP expansions with SOFTNET-PB DP software package
 - PROFIBUS DP slave with SOFTNET-PB DP Slave software package
 - PG/OP communication with STEP 7
 - S7 communication with SOFTNET-PB S7 software package
 - Open communication (SEND/RECEIVE on basis of the FDL interface) with SOFTNET-PB DP or SOFTNET-PB S7 software package
- Can be used with:
 - STEP 7, STEP 7-Micro/Win, SIMATIC PDM (for PG/OP communication)
 - SOFTNET-PB S7 (for S7 communication)
 - SOFTNET-PB DP, SOFTNET-PB DP slave (for DP)
- The appropriate OPC servers and configuration tools are included in the scope of supply of the respective communications software.

Benefits

get **Designed for Industry**

- Connection for portable PCs (e.g. for diagnostics and commissioning)
- Easy installation and startup
- Optimally coordinated with SOFTNET
- OPC as standard interface
- Uniform procedure and configuration functionality with NCM PC and STEP 7
- Can be used flexibly as PCIe x1 card in PC/IPC with PCI Express x1, x4, x8 or x16 slots

Application



The CP 5622 permits the connection of programming devices (PGs) and PCs to PROFIBUS and to the multipoint interface (MPI) of the SIMATIC S7:

- for PGs/PCs with PCI Express slot

Design

- Short PCI Express card
- 9-pin sub-D socket for connection to PROFIBUS
- Operation in the PCI Express x1, x4, x8 or x16 slots is possible

Function

The CP 5622 is operated under various software packages and offers the user the opportunity of performing functions of the programming devices and PCs by means of PROFIBUS and the multipoint interface (MPI).

Only one CP can be used per PG or PC. Similarly only one protocol (PROFIBUS DP, S7 communication or FDL) can be used per CP.

The following software packages support the CP 5622:

- STEP 7 from V5.5 SP3;
Drivers for the CP 5622 are included with STEP 7.
- SOFTNET-S7 V8.2 SP1 and higher;
This package allows the S7 programming interface to be used.
- SOFTNET-DP V8.2 SP1 and higher;
This enables the CP 5622 to be used as PROFIBUS DP master Class 1 or Class 2.
- SOFTNET-DP Slave V8.2 SP1 and higher;
For use of the CP 5622 as PROFIBUS DP slave
- NCM PC;
Drivers for the CP 5622 are included in the scope of supply (SIMATIC NET CD V8.2 SP1 and higher).
- WinCC/WinCC Flexible;
Drivers for the CP 5622 are included in the scope of supply (SIMATIC NET CD V8.2 SP1 and higher).

Technical specifications

Article No.	6GK1562-2AA00	6GK1562-2AM00
Product-type designation	CP 5622	CP 5622 MPI
Transmission rate		
Transmission rate at interface 1 in accordance with PROFIBUS	9.6 kbit/s ... 12 Mbit/s	9.6 kbit/s ... 12 Mbit/s
Interfaces		
Number of electrical connections at interface 1 in accordance with PROFIBUS	1	1
Design of electrical connection		
• at interface 1 in accordance with PROFIBUS	9-pin Sub-D socket (RS 485)	9-pin Sub-D socket (RS 485)
• of the backplane bus	PCI Express x1	PCI Express x1
Supply voltage, current consumption, power loss		
Type of supply voltage	DC	DC
Supply voltage		
• 1 from backplane bus	3.3 V	3.3 V
• 2 from the backplane bus	12 V	12 V
Relative symmetrical tolerance		
• at 3.3 V with DC	9 %	9 %
• at 12 V with DC	8 %	8 %
Consumed current		
• 1 from backplane bus with DC maximum	0.3 A	0.3 A
• 2 from backplane bus with DC maximum	0.25 A	0.25 A
Resistive loss	4 W	4 W
Permitted ambient conditions		
Ambient temperature		
• during operating	5 ... 55 °C	5 ... 55 °C
• during storage	-20 ... +60 °C	-20 ... +60 °C
• during transport	-20 ... +60 °C	-20 ... +60 °C
Relative humidity at 25 °C without condensation during operating maximum	85 %	85 %
Protection class IP	IP00	IP00
Design, dimensions and weight		
Module format	PCI Express x1	PCI Express x1
Width	18 mm	18 mm
Height	107 mm	107 mm
Depth	101 mm	101 mm
Net weight	87 g	287 g
Product properties, functions, components general		
Number of plug-in cards in the same design can be plugged in per PC station	1	1
Number of modules note	-	-

PROFIBUS

Communication for PC-based systems

CP 5622

Technical specifications (continued)

Article No.	6GK1562-2AA00	6GK1562-2AM00
Product-type designation	CP 5622	CP 5622 MPI
Performance data		
<u>Performance data open communication</u>		
Software for open communication by means of SEND/RECEIVE required	Yes, SOFTNET-PB DP / SOFTNET-PB DP Slave / SOFTNET-PB S7	Yes, SOFTNET-PB DP / SOFTNET-PB DP Slave / SOFTNET-PB S7
Number of possible connections for open communication by means of SEND/RECEIVE maximum	50	50
<u>Performance data PROFIBUS DP</u>		
Software for DP master function required	Yes, SOFTNET-PB DP	Yes, SOFTNET-PB DP
Service as DP master		
• DPV0	Yes	Yes
• DPV1	Yes	Yes
• DPV2	No	No
Number of DP slaves on DP master usable	64	64
<u>Amount of data</u>		
• of the address area of the inputs as DP master overall	14 640 byte	14 640 byte
• of the address area of the outputs as DP master overall	14 640 byte	14 640 byte
• of the address area of the inputs per DP slave	244 byte	244 byte
• of the address area of the outputs per DP slave	244 byte	244 byte
• of the address area of the diagnostic data per DP slave	244 byte	244 byte
Software for DP slave function required	Yes, SOFTNET-PB DP slave	Yes, SOFTNET-PB DP slave
Service as DP slave		
• DPV0	Yes	Yes
• DPV1	No	No
<u>Amount of data</u>		
• of the address area of the inputs as DP slave overall	122 byte	122 byte
• of the address area of the outputs as DP slave overall	122 byte	122 byte
<u>Performance data S7 communication</u>		
Software for S7 communication required	Yes, SOFTNET-PB S7	Yes, SOFTNET-PB S7
Number of possible connections for S7/PG communication maximum	8	8
<u>Performance data multi-protocol mode</u>		
Number of configurable connections per PC station	207	207
Product functions management, configuration		
Configuration software required	included in scope of delivery of required software product	included in scope of delivery of required software product

Technical specifications (continued)

Article No.	6GK1562-2AA00	6GK1562-2AM00
Product-type designation	CP 5622	CP 5622 MPI
Standards, specifications, approvals		
Standard	2004/108/EC	2004/108/EC
• for EMC	CAN/CSA C22.2 & UL 60950-1, UL 508	CAN/CSA C22.2 & UL 60950-1, UL 508
• for safety of CSA and UL	EN 61000-6-3, EN 61000-6-4	EN 61000-6-3, EN 61000-6-4
• for emitted interference	EN 61000-6-1, EN 61000-6-2	EN 61000-6-1, EN 61000-6-2
• for interference immunity		
Verification of suitability		
• CE mark	Yes	Yes
• C-Tick	Yes	Yes
Accessories		
Accessories	optional: MPI cable	included in scope of supply: MPI cable

Ordering data
Article No.

CP 5622 communications processor	
• PCI Express x1 card (32-bit) for connection of a PG or PC to PROFIBUS	6GK1562-2AA00
• PCI Express x1 card (32-bit) CP 5622 and MPI cable, 5 m	6GK1562-2AM00
Accessories	
PROFIBUS FastConnect bus connector RS485 Plug 180	6GK1500-0FC10
With 180° cable outlet, insulation displacement	
PROFIBUS FC Standard Cable GP	6XV1830-0EH10
Standard type with special design for quick assembly, 2-core, shielded, sold in meters; max. length 1 000 m, minimum order 20 m	
PROFIBUS FastConnect Stripping Tool	6GK1905-6AA00
Preset stripping tool for fast stripping of PROFIBUS FastConnect bus cables	
PROFIBUS bus terminal 12M	6GK1500-0AA10
Bus terminal for connection of PROFIBUS stations up to 12 Mbit/s with plug-in cable 1.5 m long	

Note:

For software ordering data, see page 3/227

PROFIBUS

Communication for PC-based systems

CP 5711

Overview



DP-M	DP-S	FMS	OPC	PG/OP	S7/S5
●	●		●	●	●

- USB adapter for the connection of PCs and SIMATIC PG/PC to PROFIBUS DP or MPI via USB 2.0
- Operation in extended temperature range of -20 °C to +60 °C
- Active PROFIBUS termination to supply the PROFIBUS network as end station of a segment
- Robust USB connection due to mechanical locking of the USB connector to the CP 5711 enclosure
- Communication services:
 - PROFIBUS DP master Class 1 and 2 according to IEC 61158/61784 with SOFTNET-PB DP software package
 - PROFIBUS DP slave with SOFTNET-PB DP Slave software package
 - PG/OP communication with STEP 5 or STEP 7 software package
 - S7 communication with SOFTNET-PB S7 software package
 - Open communication (SEND/RECEIVE on basis of the FDL interface) with SOFTNET-PB DP or SOFTNET-PB S7 software package
- PROFIBUS connection with up to 12 Mbit/s
- Can be used with:
 - STEP 7, STEP 7 Micro/WIN, WinCC/WinCC flexible, NCM PC, SIMATIC PDM (for PG/OP communication)
 - SOFTNET-PB S7 (for S7 communication)
 - SOFTNET-PB DP, SOFTNET-PB DP slave (for DP)
- The appropriate OPC servers and configuration tools are included in the scope of supply of the respective communication software

Benefits



- Portability and flexibility
Connection for portable PCs, e.g. for diagnostics and commissioning
- Low-cost PROFIBUS controller and device solutions for embedded PCs (without PCI or PC104 bus)
- Fault-free connection to the PROFIBUS for diagnosis at all times due to permanent installation on Profibus and connection via USB in the event of maintenance and diagnosis
- Easy installation and commissioning due to plug & play technology

Application



The CP 5711 enables the connection of SIMATIC PG/PC and PCs with USB interface to PROFIBUS and to the multi-point interface (MPI) of SIMATIC S7.

Design

- USB V2.0 connection
- Adapter with 9-pin sub-D socket for connection to PROFIBUS

Function

The CP 5711 is a USB V2.0 adapter that can be used on either a USB V2.0 port (bandwidth 480 Mbit/s) or a USB V1.1 port (1.5 Mbit/s). It can be used with various software packages and offers users the ability to perform functions of the programming devices and PCs/OPs via PROFIBUS and the multi-point interface (MPI).

The CP 5711 is powered directly via the USB interface of the PC system. Regardless of whether the USB cable is plugged in or unplugged, the active power supply of the PROFIBUS network is drawn from the external 24 V DC power supply unit.

Optional for the use of the CP 5711 in control cabinets or in the vicinity of SIMATIC S7 controllers, a mounting adapter (DIN rail) is available to attach the CP to the 35 mm DIN rail.

Only one CP per PG/PC/OP can be operated. Likewise, only one protocol (PROFIBUS DP, S7 communication, or FDL) can be used per CP.

The following software packages support the CP 5711:

- STEP 7 from V5.4 SP5;
drivers for the CP 5711 are included with STEP 7.
- SOFTNET-S7 from V7.1;
the S7 programming interface can be used with this package.
- SOFTNET-DP from V7.1;
with this, the CP 5711 can be used as PROFIBUS DP master Class 1 or 2.
- SOFTNET-DP slave from V7.1;
for operating the CP 5711 as PROFIBUS DP slave
- STEP 7-Micro/WIN;
drivers for the CP 5711 are included with STEP 7-Micro/WIN.
- WinCC/WinCC flexible;
the CP 5711 can be used as a hardware basis for the configuration tool for SIMATIC Operator Panels, Touch Panels, and Text Displays.
- NCM PC;
under Windows XP Professional
- SIMATIC PDM;
drivers for the CP 5711 are included with SIMATIC PDM.

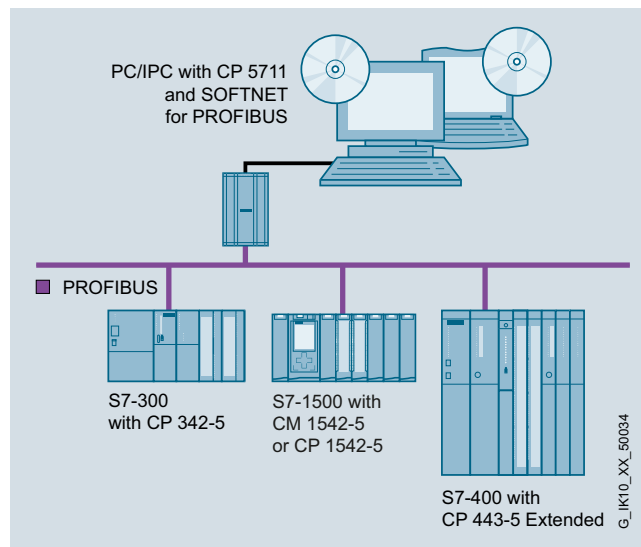

Diagnostics

Numerous diagnostic tools are available for the CP 5711. For support, the module also includes comprehensive LED diagnostics. Operating and signal states can be recognized quickly via five LEDs.

Configuration

- The S7 communication, open communication and DP protocols can be configured in STEP 7 or NCM PC.
- A configuration tool is included in the scope of delivery of the PROFIBUS SOFTNET software packages.

PROFIBUS

Communication for PC-based systems

CP 5711**Technical specifications**

Order No.	6GK1571-1AA00	6GK1571-1AM00
Product-type designation	CP 5711	CP 5711 MPI
Transmission rate		
Transmission rate at interface 1 in accordance with PROFIBUS	9.6 kbit/s ... 12 Mbit/s	9.6 kbit/s ... 12 Mbit/s
Interfaces		
Number of electrical connections at interface 1 in accordance with PROFIBUS	1	1
Number of interfaces according to USB	1	1
Number of electrical connections for power supply	1	1
Design of electrical connection		
• at interface 1 in accordance with PROFIBUS	9-pin Sub-D socket (RS 485)	9-pin Sub-D socket (RS 485)
• for power supply	2-pin terminal block	2-pin terminal block
• of the USB interface	Standard-B socket with mechanical interlock	Standard-B socket with mechanical interlock
Standard for interfaces USB 2.0	Yes	Yes
Supply voltage, current consumption, power loss		
Type of supply voltage	DC	DC
Type of power supply optional external supply	Yes	Yes
Supply voltage		
• from USB	5 V	5 V
• external	24 V	24 V
- minimum	18 V	18 V
- maximum	30 V	30 V
• note	Supplied directly from USB provided that supply from PC is adequate; alternative external supply is possible	Supplied directly from USB provided that supply from PC is adequate; alternative external supply is possible
Relative symmetrical tolerance		
• at 5 V with DC	5 %	5 %
• at 24 V with DC	5 %	5 %
Consumed current		
• from USB	0.5 A	0.5 A
• from external supply voltage at 24 V with DC maximum	0.3 A	0.3 A
Resistive loss	2.5 W	2.5 W
Permitted ambient conditions		
Ambient temperature		
• during operating	0 ... 60 °C	5 ... 60 °C
• during storage	-40 ... +60 °C	-20 ... +60 °C
• during transport	-40 ... +60 °C	-20 ... +60 °C
Relative humidity at 25 °C without condensation during operating maximum	85 %	85 %
Protection class IP	IP20	IP20
Design, dimensions and weight		
Module format	USB V2.0 adapter	USB V2.0 adapter
Width	85 mm	85 mm
Height	137 mm	137 mm
Depth	35 mm	35 mm
Net weight	300 g	500 g
Mounting type 35 mm DIN rail mounting	Yes	Yes
Mounting type	Mounting on DIN rail with optional mounting rail support	Mounting on DIN rail with optional mounting rail support

Technical specifications (continued)

Order No.	6GK1571-1AA00	6GK1571-1AM00
Product-type designation	CP 5711	CP 5711 MPI
Product properties, functions, components general		
Number of plug-in cards in the same design can be plugged in per PC station	1	1
Number of modules note	-	-
Performance data		
<u>Performance data open communication</u>		
Software for open communication by means of SEND/RECEIVE required	Yes, SOFTNET-PB DP / SOFTNET-PB DP Slave / SOFTNET-PB S7	Yes, SOFTNET-PB DP / SOFTNET-PB DP Slave / SOFTNET-PB S7
Number of possible connections for open communication by means of SEND/RECEIVE maximum	50	50
<u>Performance data PROFIBUS DP</u>		
Software for DP master function required	Yes, SOFTNET-PB DP	Yes, SOFTNET-PB DP
Service as DP master		
• DPV0	Yes	Yes
• DPV1	No	No
• DPV2	No	No
Number of DP slaves on DP master usable	64	64
Amount of data		
• of the address area of the inputs as DP master overall	15 616 byte	15 616 byte
• of the address area of the outputs as DP master overall	15 616 byte	15 616 byte
• of the address area of the inputs per DP slave	244 byte	244 byte
• of the address area of the outputs per DP slave	244 byte	244 byte
• of the address area of the diagnostic data per DP slave	244 byte	244 byte
Software for DP slave function required	Yes, SOFTNET-PB DP slave	Yes, SOFTNET-PB DP slave
Service as DP slave		
• DPV0	Yes	Yes
• DPV1	No	No
Amount of data		
• of the address area of the inputs as DP slave overall	122 byte	122 byte
• of the address area of the outputs as DP slave overall	122 byte	122 byte
<u>Performance data S7 communication</u>		
Software for S7 communication required	Yes, SOFTNET-PB S7	Yes, SOFTNET-PB S7
Number of possible connections for S7/PG communication maximum	8	8
<u>Performance data multi-protocol mode</u>		
Number of configurable connections per PC station	207	207
Product functions management, configuration		
Configuration software required	included in scope of delivery of required software product	included in scope of delivery of required software product

PROFIBUS

Communication for PC-based systems

CP 5711

Technical specifications (continued)

Order No.	6GK1571-1AA00	6GK1571-1AM00
Product-type designation	CP 5711	CP 5711 MPI
Product functions Diagnosis		
Product function Port diagnostics	Yes	Yes
Standards, specifications, approvals		
Standard		
• for EMC	2004/108/EC	2004/108/EC
• for safety of CSA and UL	CAN/CSA C22.2 & UL 60950-1	CAN/CSA C22.2 & UL 60950-1
• for emitted interference	EN 61000-6-3, EN 61000-6-4	EN 61000-6-3, EN 61000-6-4
• for interference immunity	EN 61000-6-1, EN 61000-6-2	EN 61000-6-1, EN 61000-6-2
Verification of suitability		
• CE mark	Yes	Yes
• C-Tick	Yes	Yes
Accessories		
Accessories	optional: MPI cable, mounting rail support	included in scope of supply: MPI cable / optional: rail support

Article No.	6GK1571-1AA00-0AD0
Product-type designation	Steckleitung USB für CP 5711
Product description	
Acceptability for application	For connecting a CP 5711 to the USB interface of a PG/PC/IPC or notebook
Cable length	2 m
Mechanical data	
Net weight	0.1 kg

Ordering data	Article No.	Article No.
CP 5711 communications processor for connection of a programming device or notebook to PROFIBUS or MPI, under 32 bit in connection with PROFIBUS SOFTNET software or STEP 7; German/English • USB V2.0 adapter • USB V2.0 adapter CP 5711 and MPI cable, 5 m	6GK1571-1AA00 6GK1571-1AM00	Accessories PROFIBUS FastConnect bus connector RS485 Plug 180 With 180° cable outlet, insulation displacement 6GK1500-0FC10
		PROFIBUS FC Standard Cable GP Standard type with special design for quick assembly, 2-core, shielded, sold in meters; max. length 1 000 m, minimum order 20 m 6XV1830-0EH10
		PROFIBUS FastConnect Stripping Tool Preset stripping tool for fast stripping of PROFIBUS FastConnect bus cables 6GK1905-6AA00
		PROFIBUS bus terminal 12M Bus terminal for connection of PROFIBUS stations up to 12 Mbit/s with plug-in cable 1.5 m long 6GK1500-0AA10
		Mounting rail support Compartment for CP 5711 enclosure; fastened mechanically to 35 mm DIN rail 6GK1571-1AA00-0AH0

Note:

For software ordering data, see page 3/227

Overview

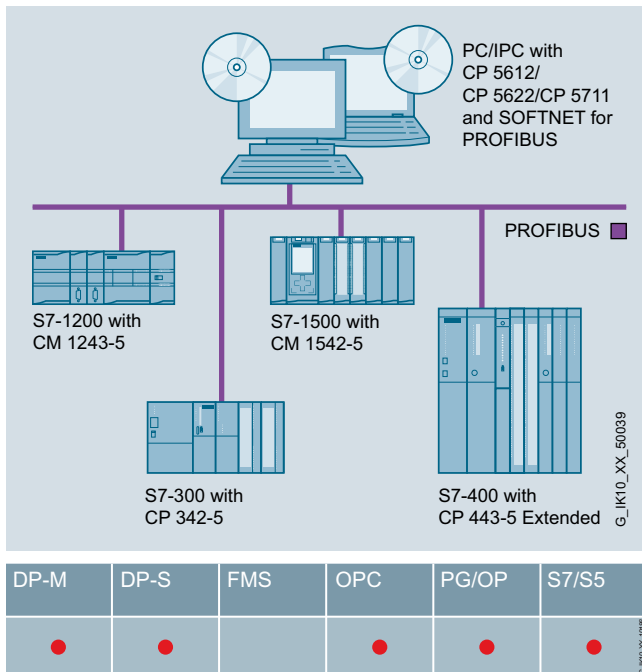

- Software for connecting PCs/programming devices and notebooks to programmable controllers
- Communication services:
 - PROFIBUS DP master Class 1 and 2 with acyclic expansions
 - PROFIBUS DP slave
 - PG/OP communication
 - S7 communication
 - Open communication (SEND/RECEIVE) based on the FDL interface
- The appropriate OPC servers and configuration tools are included in the scope of supply of the respective communications software

Benefits



- Maximum transparency due to integrated communication with SIMATIC via PROFIBUS and OPC as the standard interface
- Low-cost connection
 - as PROFIBUS DP master class 1 or master class 2 with SOFTNET-PB DP
 - as PROFIBUS DP slave with SOFTNET-PB DP slave
 - to S7 communication with SOFTNET-PB S7
- Simple and low-cost commissioning thanks to uniform procedure and configuration functionality with NCM PC and STEP 7

Application



With SOFTNET for PROFIBUS, PCs can be connected to programmable controllers, such as SIMATIC S7, over PROFIBUS.

The following user interfaces are available:

- DP protocol
- PG/OP communication for SIMATIC S7
- S7 communication
- Open communication (SEND/RECEIVE) based on the FDL interface

SOFTNET is available for the following interfaces:

- CP 5612 (PCI, 32 bit)
- CP 5622 (PCIe x1)
- CP 5711 (USB V2.0)

The operating systems that are supported are listed in the ordering data for the SOFTNET software.

PROFIBUS

Communication for PC-based systems

SOFTNET for PROFIBUS

Function

Software for DP protocol (SOFTNET-PB DP)

- **DP Master Class 1**

SOFTNET-PB DP offers DP master class 1 functionality. The central controller exchanges information with the DP slaves (e.g. ET 200S) in a specified, constantly repeating message cycle. The OPC programming interface provides the PC programmer with function calls for data transfer. The DP interface also provides the SYNC and FREEZE functions as well as activation and deactivation of slaves.

The DP function expansions for masters of Class 1 make it possible to perform read and write functions (DS_READ, DS_WRITE) as well as acknowledgement of alarms (ALARM_ACK) at the same time as processing cyclic data communication. Data that are to be transferred in acyclic mode (e.g. parameterization data) are only rarely changed in comparison to the cyclic measured values, and are transferred at lower priority in parallel with the cyclic high-speed user data transfer. Alarm acknowledgement by the master ensures reliable transfer of the alarms from DP slaves.

- **DP Master Class 2**

In addition to DP master Class 1 services, SOFTNET-PB DP also provides DP Master Class 2 services. Devices of this type are used (programming, configuration or control devices) during start-up, for configuring the DP system or for controlling the plant during normal operation (diagnostics). The DP programming interface provides the following services: Reading master diagnostics, slave diagnostics, inputs/outputs of a slave, configuration data and modifying slave addresses. These extended DP functions comprise non-isochronous access to the parameters and measured values of a slave (e.g. field devices of process automation and intelligent HMI devices). This type of slave must be supplied with extensive parameter data during start-up and during normal operation (DS_READ, DS_WRITE).

- **DP slave (SOFTNET-PB DP slave)**

A DP slave is an I/O station that reads in input data and transfers output data to the I/O. The volume of input and output information is determined by the user application and can be a maximum of 122 bytes each. For the slave interface, a simple example GSD file is provided that can be adapted by the user to the slave application. This GSD file can be configured using any configuration tool which complies with the PROFIBUS DP specification IEC 61158/EN 50170, e.g. STEP 7 or NCM PC.

Software for PG/OP communication

Special programming device packages are not required because the drivers are included in the STEP 7 scope of supply.

Software for S7 communication (SOFTNET-PB S7)

SIMATIC S7 system components communicate with each other using S7 communication functions. The S7 programming interface provides programming device/PC user programs with access to SIMATIC S7 system components. This provides easy, flexible access to the data of the SIMATIC S7 controller.

The following services are available with S7 communication:

Administrative services

- Connection management
- Mini database
- Trace

Data transfer services

- Read/write variables
- BSEND/BRECEIVE (up to 64 KB per task)

Software for open communication (SEND/RECEIVE based on the FDL interface)

This interface based on Layer 2 is used for communication between

- PG/PC and SIMATIC S5
- PG/PC and SIMATIC S7
- PG/PC and PG/PC

used

SEND/RECEIVE offers the following services:

- Management services
- Connection establishment services
- Data transfer services

This interface is included in SOFTNET-PB DP and SOFTNET-PB S7. No configuration is necessary.

User interfaces

- **OPC interface**

The OPC server included in the respective software package can be used as the standard programming interface for the PROFIBUS DP, open communication and S7 communication protocols for linking automation technology applications to OPC-capable Windows applications (Office, HMI systems, etc.).

Mode of operation

With SOFTNET, the complete protocol stack is processed in the PC.

This architecture means that in contrast to the CP 5613 or CP 5614 products, the performance of the SOFTNET packages is dependent on the configuration or loading of the PC used.

Configuration

- The S7 communication protocol, open communication protocol and DP protocol are configured in STEP 7/ NCM PC V5.1 + SP2 and higher.
- A configuration tool is included in the scope of delivery of the PROFIBUS software packages.

Technical specifications

Performance data	CP 5612/CP 5622/CP 5711
<u>Mono protocol mode</u>	
Number of connectable DP slaves	max. 60
Number of FDL tasks waiting	max. 50
Number of PG/OP and S7 connections	max. 8
• DP master	DP-V0, DP-V1 with SOFTNET-PB DP
• DP slave	DP-V0, DP-V1 with SOFTNET-PB DP slave

Ordering data

SOFTNET-PB S7

Software for S7 communication, incl. FDL protocol with OPC server and configuration tool, runtime software, software and electronic manual on DVD-ROM, license key on USB stick, Class A; for CP 5612 (Win 7 and higher), CP 5622 (Win 7 and higher), CP 5711

SOFTNET-PB S7 V12

for 32/64-bit:
Windows 7 Professional/Ultimate;
for 32/64-bit: Windows 8 Pro;
for 64-bit: Windows 2008 Server R2;
for 64-bit: Windows 2012 Server;
German/English

- Single License for one installation

Software Update Service

For 1 year, with automatic extension;
requirement:
Current software version

Upgrade

- From Edition 2006 to SOFTNET-S7 Edition 2008 or V12
- From V6.0, V6.1, V6.2 or V6.3 to SOFTNET-S7 Edition 2008 or V12

SOFTNET-PB DP

Software for DP protocol (master Class 1 and 2), incl. FDL protocol with OPC server and configuration tool; runtime software, software and electronic manual on DVD-ROM, license key on USB stick; for CP 5612 (Win 7 and higher), CP 5622 (Win 7 and higher), CP 5711

SOFTNET-PB DP V12

for 32/64-bit:
Windows 7 Professional/Ultimate;
for 32/64-bit: Windows 8 Pro;
for 64-bit: Windows 2008 Server R2;
for 64-bit: Windows 2012 Server;
German/English

- Single License for one installation

Article No.

6GK1704-5CW12-0AA0

6GK1704-5CW00-3AL0

6GK1704-5CW00-3AE0

6GK1704-5CW00-3AE1

6GK1704-5DW12-0AA0

Article No.

Software Update Service

For 1 year, with automatic extension;
requirement:
Current software version

Upgrade

- From Edition 2006 to SOFTNET-DP Edition 2008 or V12
- From V6.0, V6.1, V6.2 or V6.3 to SOFTNET-DP Edition 2008 or V12

SOFTNET-PB DP slave

Software for DP slave, with OPC server and configuration tool, single license for one installation, runtime software, software and electronic manual on DVD-ROM, license key on USB stick, Class A; for CP 5612 (Win 7 and higher), CP 5622 (Win 7 and higher), CP 5711

SOFTNET-PB DP slave V12

for 32/64-bit:
Windows 7 Professional/Ultimate;
for 32/64-bit: Windows 8 Pro;
for 64-bit: Windows 2008 Server R2;
for 64-bit: Windows 2012 Server;
German/English

- Single License for one installation

Software Update Service

For 1 year, with automatic extension;
requirement:
Current software version

Upgrade

- From Edition 2006 to SOFTNET-DP Slave Edition 2008 or V12
- From V6.0, V6.1, V6.2 or V6.3 to SOFTNET-DP Slave Edition 2008 or V12

6GK1704-5DW00-3AL0

6GK1704-5DW00-3AE0

6GK1704-5DW00-3AE1

6GK1704-5SW12-0AA0

6GK1704-5SW00-3AL0

6GK1704-5SW00-3AE0

6GK1704-5SW00-3AE1

Note:

The Windows XP software version is still available for older CPs; see the Industry Mall: <http://www.siemens.com/industrymall>.

PROFIBUS

Communication for PC-based systems

OPC server for PROFIBUS

Overview

- Standardized, open multi-vendor interface
- Interfacing of OPC-capable Windows applications to DP, FMS, S7 communication and open communication (SEND/RECEIVE) based on the FDL interface
- OPC Scout with browser functionality as an OPC client and OX-Data-Control/.NET Data Control for simple OPC client creation
- The relevant OPC servers are supplied with each communication software package

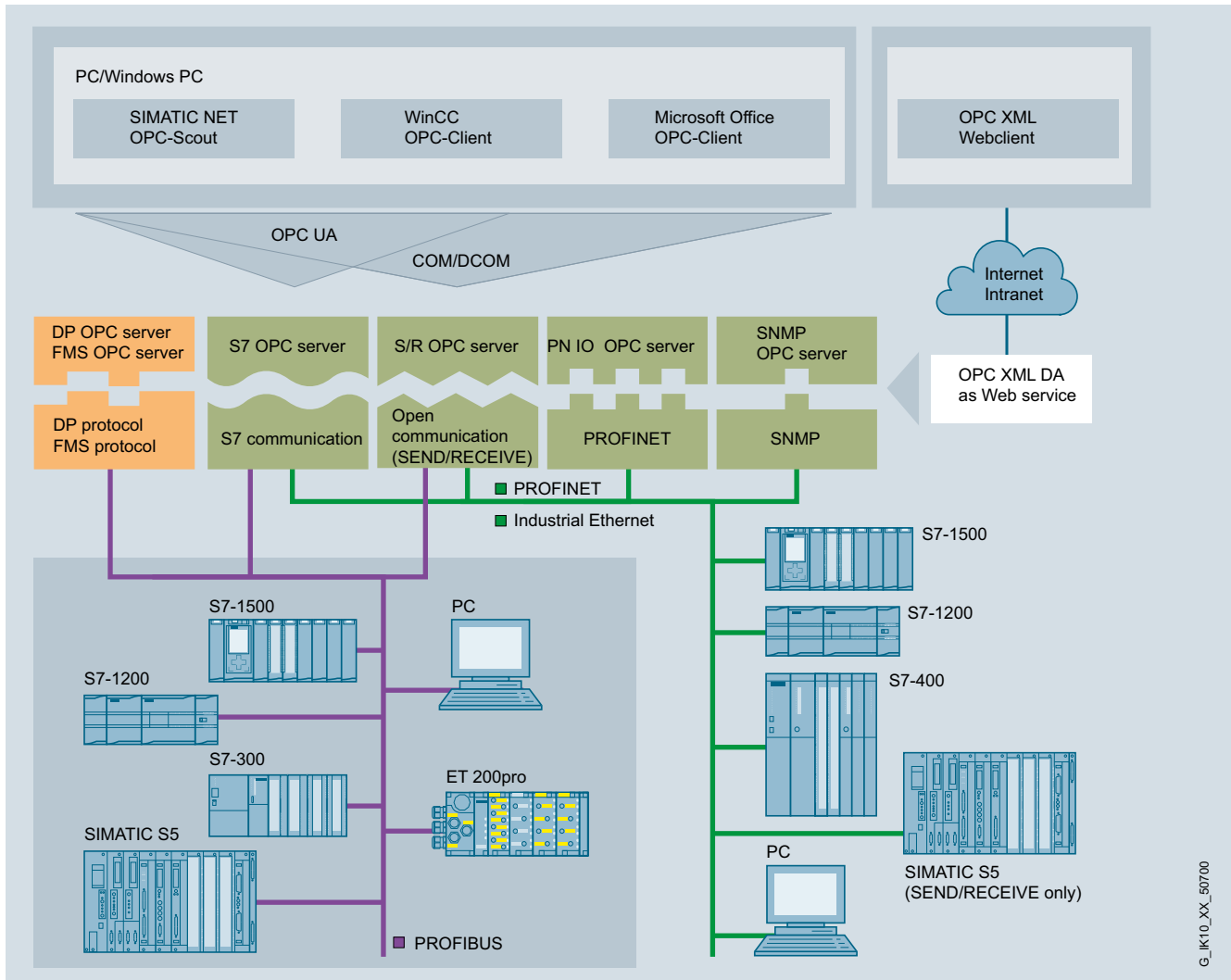

System integration with OPC server

Benefits

get Designed for Industry

- Different networks and protocols can be easily used thanks to the uniform interface
- Reduced training and familiarization costs
- Easy interfacing in the system environment and office applications over C++, Visual Basic and .NET interfaces
- Fast creation of applications
- Easy handling and cost-effective because the corresponding OPC server is included in the scope of supply of the respective communications software

Application



OPC (Openness, Productivity & Collaboration) is a standardized, open, and vendor-independent interface that is widely used in automation.

A fundamental distinction is made between the classic OPC and its consistent further development OPC UA (Unified Architecture). Smooth migration to the new OPC UA standard is easily possible; this offers further value added such as security. The SIMATIC NET OPC servers offer the two interfaces OPC UA and classic OPC for PROFIBUS.

The following communications interfaces are available over OPC for PROFIBUS:

- DP communication for PROFIBUS DP
- DP-V0 Master Class 1 and Master Class 2
DP-V1 Master Class 1 and Master Class 2
PROFIdrive V3 interface for profile server
- FMS communication for PROFIBUS FMS
- S7 communication
- Open communication (SEND/RECEIVE) based on the FDL interface

The OPC server offers:

- Data Access interface 2.05
- Alarm&Event interface 1.1
- OPC XML DA interface 1.0
- Integration of automation products of different manufacturers
- The same, easy-to-use user interface for different components
- Can be accessed from every computer in the LAN
- High-performance data access over the Custom Interface (C++, NET)
- Easy to use with the "Automation Interface" (VB, NET) or the supplied OCX Data Control or .NET Data Control
- Grouping of variables (items); this way large quantities of data can be processed in a short time

Function

- Open standardization of the addressing using logical names for objects from an automation component or an automation system
- Supports STEP 7 symbols
- Efficient data transfer from a process component to an application for further processing
- One client application can use several servers simultaneously
- Simultaneous execution of more than one client is possible on one OPC server
- The communication protocols can be operated in parallel
- Interfaces
 - "Custom Interface" for high-performance C++/NET applications
 - "Automation Interface" for easily created Visual Basic applications (or similar)
 - OCX Data Control or .NET Data Control for simple connection to Windows applications that support COM/DCOM
 - XML DA interface;
Data access to S7 CPUs is therefore possible over the Internet.

Configuration

- The communication parameters are configured using only the tools of the configuration software (configuration console, SIMATIC NCM PC or STEP 7 V5.1 + SP2 and higher)
- A configuration tool is included in the scope of delivery of the PROFIBUS software packages.

PROFIBUS

Communication for PC-based systems

OPC server for PROFIBUS

Function (continued)

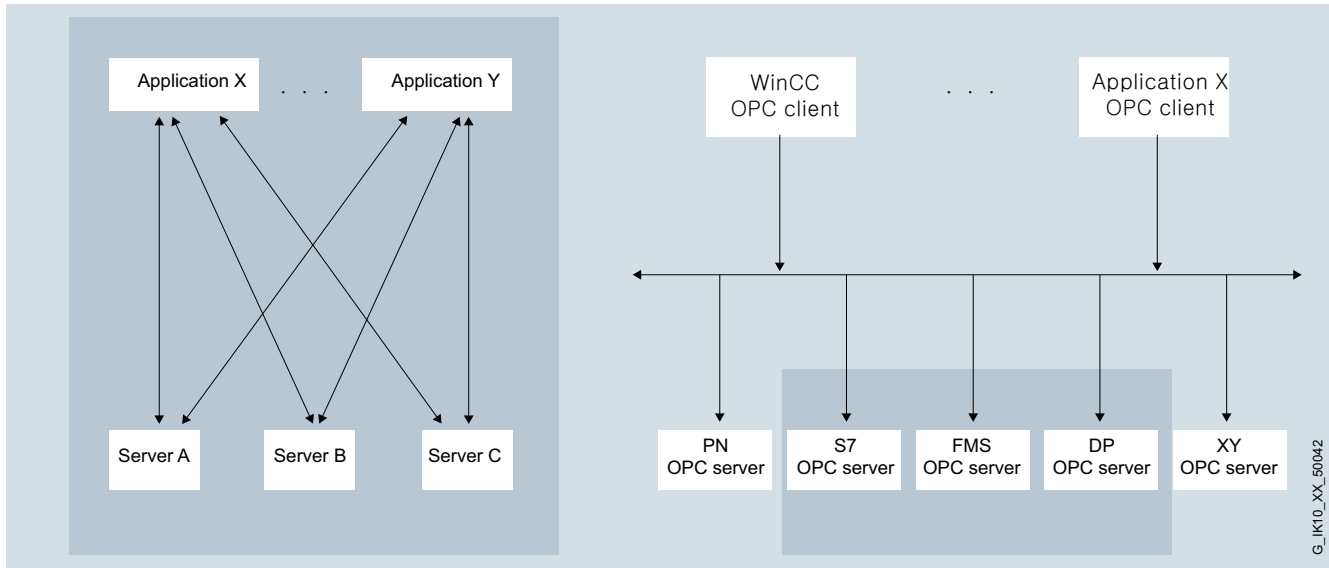

Comparison of conventional client/server architecture with an OPC architecture

Technical specifications

Programming	<ul style="list-style-type: none"> • Synchronous and asynchronous reading and writing of variables • Monitoring of variables using the OPC server with a signal to the client when a change occurs • Use of quantity operations; so a large amount of data can be processed in a short time.
Interfaces	<ul style="list-style-type: none"> • Custom Interface (C++, NET); for high OPC performance • Automation Interface (VB, Excel, Access, Delphi, ...) for ease-of-use • Graphics with OCX or .NET Data Control; for configuring instead of programming • OPC XML-Interface for Data Access
Protocols	<ul style="list-style-type: none"> • S7 communication • Open communication (SEND/RECEIVE) • PROFIBUS DP • PROFIBUS FMS

Product versions	include OPC servers for:
HARDNET-PB DP	PROFIBUS DP, XML-DA
HARDNET-PB S7	S7 communication, XML-DA
FMS-5613	FMS communication, XML-DA
SOFTNET-PB S7	S7 communication, XML-DA
SOFTNET-PB DP	PROFIBUS DP, XML-DA
SOFTNET-PB DP slave	PROFIBUS DP, Slave XML-DA
DP-Base software for HARDNET-PB CPs	Open communication (FDL) PROFIBUS DP Master, Access to DP-slave of the CP 5614 A3/CP 5624, XML-DA

G_IK10_XX_50042

Overview

OPC (**O**penness, **P**roductivity & **C**ollaboration) is a standardized, open, and vendor-independent interface that is widely used in automation. OPC UA (**U**nified **A**rchitecture) is the result of consistent further development of this standard, offering additional functions such as security or redundancy.

S7 OPC Redundancy is a software product compliant with the OPC UA standard that enables the redundant configuration of OPC UA servers to SIMATIC S7. The availability of automation data to operator control and monitoring systems is guaranteed thanks to the redundant use of OPC UA servers. This requires neither additional cabling for synchronizing the redundant OPC UA servers, nor additional programming overhead in the PC. The OPC UA servers are synchronized via high-performance Industrial Ethernet network access points at 10/100 and 1 000 Mbps. S7 OPC Redundancy represents an integrated customer solution for all SIMATIC NET S7 SOFTNET and HARDNET software products in the automation world.

Benefits

- Enhanced plant availability thanks to redundant OPC UA servers that guarantee plant access for operator control and monitoring systems
- Secures investments thanks to the use of existing applications (OPC clients) and flexible application options, regardless of the SIMATIC S7 controller used
- Improved utilization of IT resources thanks to even distribution of the OPC clients among the redundant OPC servers
- Easy and low-cost commissioning thanks to uniform procedure and configuration functionality with NCM PC and STEP 7

Application

The redundant OPC UA server software enables redundant configuration of SIMATIC NET OPC UA servers. Failure of one OPC UA server, as a result of power outage or system failure, for example, results in immediate use of the other OPC UA server, and continuation of the existing OPC UA client connection. This ensures increased availability of automation data to operator control and monitoring systems.

Design

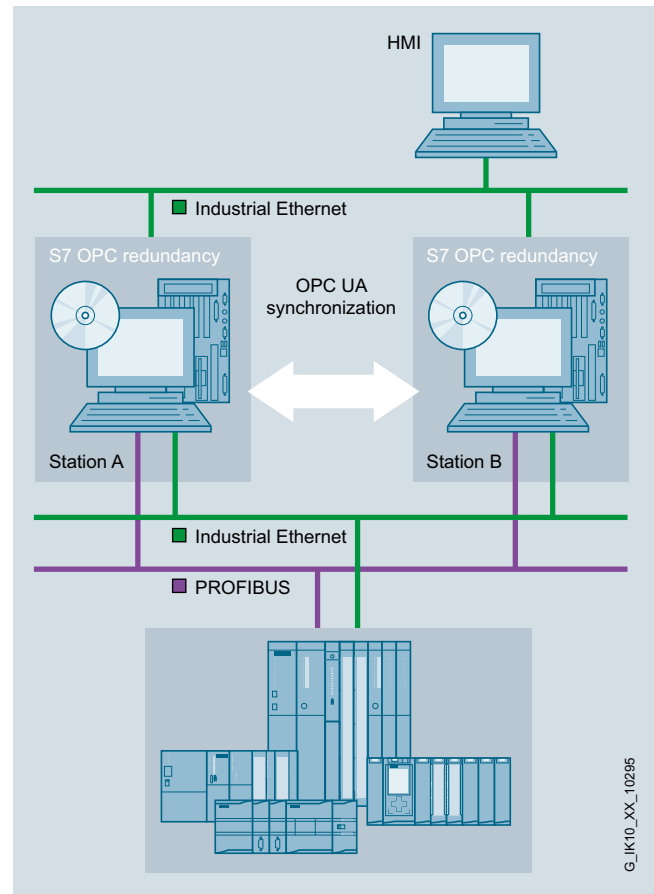

Redundant use of OPC servers

A redundant OPC UA server system comprises the following:

Server PC

with

- Operating system for Windows server
- SOFTNET-PB S7 or HARDNET-PB S7 software based on OPC UA server
- S7 OPC Redundancy software

The redundant operation of up to two OPC UA servers is possible.

Client PC (HMI)

- Software for OPC clients that supports OPC UA (incl. REDCONNECT functionalities in accordance with OPC UA specification)

The communication parameters are configured using STEP 7 or SIMATIC NET NCM PC. A configuration tool is included in the scope of delivery of the SIMATIC NET PC products.

PROFIBUS

Communication for PC-based systems

S7 OPC Redundancy for PROFIBUS

Function

S7 OPC Redundancy enables the setup of redundant OPC UA servers, thus ensuring plant access for the operator control and monitoring systems.

This means, for example, that the information synchronization between two SIMATIC NET S7 OPC servers via the S7 OPC Redundancy software package is guaranteed. This is handled transparently for the OPC Client application so that in the event of a fault, the redundant OPC server takes over the tasks from the failed OPC server system.

Data exchange between the OPC clients and the OPC servers takes place via the standardized OPC UA communication. Communication with the SIMATIC S7 controller takes place using the S7 protocol. This is ensured by the software products SIMATIC NET SOFTNET or HARDNET-S7 for PROFIBUS that are necessary as the basis for SIMATIC NET IE S7 OPC Redundancy.

The S7 OPC Redundancy software package supports:

- High availability;
Failure of one OPC UA server results in immediate use of the other OPC UA server, and continuation of the existing OPC UA client connection. The basis for this is the OPC UA synchronization that ensures synchronization of the necessary client information.
- Load compensation;
Even distribution of OPC clients among the available OPC servers

Configuration

A configuration tool is included in the scope of delivery of the corresponding packages.

Ordering data

Article No.

S7 OPC Redundancy

Software for redundant OPC servers, Runtime software, software and electronic manual on CD-ROM, license key on USB stick, Class A

S7 OPC Redundancy V12 for PROFIBUS

for 64-bit Windows 2008 server R2; English/German

- Single License for one installation

6GK1706-5CW12-0AA0

Software Update Service

For 1 year, with automatic extension; requirement: Current software version

6GK1706-5CW00-3AL0

Ordering data	Article No.	Article No.
HARDNET-PB DP Development Kit Software HARDNET-PB DP Development Kit for integration in other operating system environments <i>For CP 5603, CP 5613 A2, CP 5614 A2, CP 5613 A3, CP 5614 A3, CP 5623, CP 5624</i>	see http://www.siemens.com/simatic-net/dk5613	
Software upgrade <i>For CO 5603, CO 5613 A, CO 5614 A, CO 5613 A3, CP 5614 A3, CP 5623, CP 5624 to Edition 2008 or V12</i>	6GK1561-3AA01-3AE0	
HARDNET-PB DP Software for DP, incl. PG and FDL protocol, OPC server and configuration tool; runtime software, software and electronic manual on DVD-ROM, license key on USB flash drive, Class A <i>For CP 5603, CP 5613 A2, CP 5614 A2, , CP 5613 A3, CP 5614 A3, CP 5623, CP 5624</i>		
HARDNET-PB DP V12 for 32/64-bit: Windows 7 Professional/Ultimate for 32/64-bit: Windows 8 Pro for 64-bit: Windows 2008 Server R2 for 64-bit: Windows 2012 Server German/English • Single License for one installation	6GK1713-5DB12-0AA0	
Software Update Service for 1 year with automatic extension Requirement: current software version	6GK1713-5DB00-3AL0	
Upgrade • from Edition 2006 or 2007 to DP-5613 Edition 2008 or HARDNET-PB DP V12 • from V6.0, V6.1, V6.2 or V6.3 to DP-5613 Edition 2008 or HARDNET-PB DP V12	6GK1713-5DB00-3AE0 6GK1713-5DB00-3AE1	
		HARDNET-PB S7 Software for S7 communication incl. PG and FDL protocol, OPC server and configuration tool; runtime software, software and electronic manual on DVD-ROM, license key on USB flash drive, Class A <i>for CP 5603, CP 5613 A2, CP 5614 A2, , CP 5613 A3, CP 5614 A3, CP 5623, CP 5624</i>
		HARDNET-PB S7 V12 for 32/64-bit: Windows 7 Professional/Ultimate for 32/64-bit: Windows 8 Pro for 64-bit: Windows 2008 Server R2 for 64-bit: Windows 2012 Server German/English • Single License for one installation
		6GK1713-5CB12-0AA0
		Software Update Service for 1 year with automatic extension Requirement: current software version
		6GK1713-5CB00-3AL0
		Upgrade • from Edition 2006 or 2007 to S7-5613 Edition 2008 or HARDNET-PB S7 V12 • from V6.0, V6.1, V6.2 or V6.3 to S7-5613 Edition 2008 or HARDNET-PB S7 V12
		6GK1713-5CB00-3AE0
		6GK1713-5CB00-3AE1
		SOFTNET-PB S7 Software for S7 communication, including FDL protocol with OPC server and configuration tool, runtime software, software and electronic manual on DVD-ROM, license key on USB flash drive, Class A <i>for CP 5612 (Win 7 or higher), CP 5622 (Win 7 or higher), CP 5711</i>
		SOFTNET-PB S7 V12 for 32/64-bit: Windows 7 Professional/Ultimate for 32/64-bit: Windows 8 Pro for 64-bit: Windows 2008 Server R2 for 64-bit: Windows 2012 Server German/English • Single License for one installation
		6GK1704-5CW12-0AA0
		Software Update Service For 1 year with automatic extension; requirement: current software version
		6GK1704-5CW00-3AL0
		Upgrade • from Edition 2006 to SOFTNET-S7 Edition 2008 or V12 • from V6.0, V6.1, V6.2 or V6.3 to SOFTNET-S7 Edition 2008 or V12
		6GK1704-5CW00-3AE0
		6GK1704-5CW00-3AE1

PROFIBUS

Communication for PC-based systems

Software

Ordering data**Article No.****Article No.****SOFTNET-PB DP**

Software for DP protocol (Master Class 1 and 2), including FDL protocol with OPC server and configuration tool; runtime software, software and electronic manual on DVD-ROM, license key on USB flash drive

for CP 5612 (Win 7 or higher), CP 5622 (Win 7 or higher), CP 5711

SOFTNET-PB DP V12

for 32/64-bit:
Windows 7 Professional/Ultimate
for 32/64-bit: Windows 8 Pro
for 64-bit: Windows 2008 Server R2
for 64-bit: Windows 2012 Server
German/English

- Single License for one installation

Software Update Service

for 1 year with automatic extension
Requirement: current software version

Upgrade

- from Edition 2006 to SOFTNET-DP Edition 2008 or V12
- from V6.0, V6.1, V6.2 or V6.3 to SOFTNET-DP Edition 2008 or V12

6GK1704-5DW12-0AA0**6GK1704-5DW00-3AL0****6GK1704-5DW00-3AE0****6GK1704-5DW00-3AE1****SOFTNET-PB DP slave**

Software for DP slave, with OPC server and configuration tool, Single License for one installation, runtime software, software and electronic manual on DVD-ROM, license key on USB flash drive, Class A

for CP 5612 (Win 7 or higher), CP 5622 (Win 7 or higher), CP 5711

SOFTNET-PB DP slave V12

for 32/64-bit:
Windows 7 Professional/Ultimate
for 32/64-bit: Windows 8 Pro
for 64-bit: Windows 2008 Server R2
for 64-bit: Windows 2012 Server
German/English

- Single License for one installation

Software Update Service

for 1 year with automatic extension
Requirement: current software version

Upgrade

- from Edition 2006 to SOFTNET-DP Slave Edition 2008 or V12
- from V6.0, V6.1, V6.2 or V6.3 to SOFTNET-DP Slave Edition 2008 or V12

6GK1704-5SW12-0AA0**6GK1704-5SW00-3AL0****6GK1704-5SW00-3AE0****6GK1704-5SW00-3AE1**Note:

The Windows XP software version is still available for older CPs; see the Industry Mall: <http://www.siemens.com/industrymall>

Overview

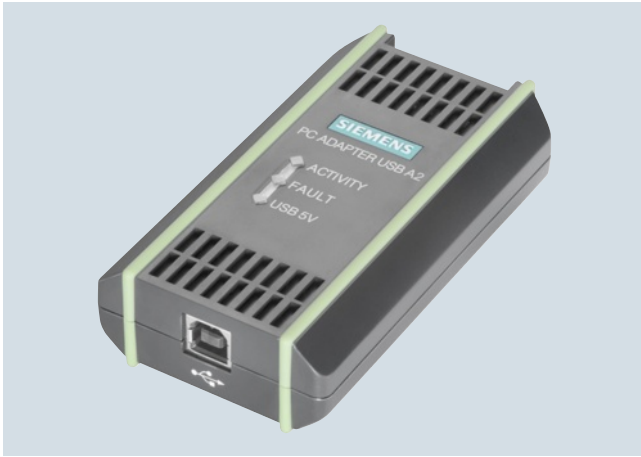

DP-M	DP-S	FMS	PG/OP	S7/S5	
			●		

USB adapter for the connection of PCs/Notebooks and SIMATIC PG/PC to the SIMATIC S7 automation system via USB interface.

- For connection to USB 1.1, 2.0 and 3.0 interfaces
- Power supply from the USB interface
- PROFIBUS connection with up to 12 Mbit/s
- Support for routing
- Automatic transmission rate and profile search
- Can be used as of Windows XP SP2
- As of Windows 7, can also be used with 64-bit system
- Scope of delivery:
 - PC adapter USB A2
 - CD with drivers for the PC adapter USB A2
 - USB cable
 - MPI cable 0.3 m

Benefits

get **Designed for Industry**

- Portability and flexibility; Connection for portable PCs, e.g. for diagnostics and commissioning
- Easy installation and commissioning due to plug & play technology
- Power supply via the USB interface

Application

The PC adapter USB A2 enables the connection of SIMATIC PG/PC and PCs with USB interface to PROFIBUS and to the multi-point interface (MPI) of SIMATIC S7.

It can be used with Windows XP SP2 and higher and supports all MPI and PROFIBUS baud rates.

Design

- USB port
- Adapter with 9-pin sub-D socket for connection to PROFIBUS or MPI

Function

The PC adapter USB A2 can be operated both on a USB V1.1 port and on a USB V2.0 or USB V3.0 port. It offers users the ability to perform both programming device and PC/OP functions via PROFIBUS and the multi-point interface (MPI). Only one USB A2 PC adapter can be operated per PG/PC/OP.

The USB A2 PC adapter is powered directly via the USB interface of the PC system.

The following software packages support the USB A2 PC adapter:

- STEP 7
- TIA Portal
- NCM PC
- SIMATIC PDM
- Drive ES

Diagnostics

Three LEDs are available for diagnosing the USB A2 PC adapter. These LEDs allow quick detection of various operating states and signal states.

PROFIBUS

Communication for PC-based systems

PC adapter USB A2**Technical specifications**

Article No.	6GK1571-0BA00-0AA0
Product-type designation	PC adapter USB A2
Transmission rate	
Transmission rate at interface 1 in accordance with PROFIBUS	9.6 kbit/s ... 12 Mbit/s
Interfaces	
Number of electrical connections at interface 1 in accordance with PROFIBUS	1
Number of interfaces according to USB	1
Design of electrical connection	
• at interface 1 in accordance with PROFIBUS	9-pin Sub-D socket (RS 485)
• of the USB interface	Standard-B socket
Supply voltage, current consumption, power loss	
Type of supply voltage	DC
Type of power supply optional external supply	No
Supply voltage	
• from USB	5 V
• note	Supply direct from USB
Relative symmetrical tolerance at 5 V with DC	5 %
Consumed current from USB	0.2 A
Resistive loss	1 W

Article No.	6GK1571-0BA00-0AA0
Product-type designation	PC adapter USB A2
Permitted ambient conditions	
Ambient temperature	
• during operating	0 ... 60 °C
• during storage	-40 ... +70 °C
• during transport	-40 ... +70 °C
Relative humidity at 30 °C during the operating phase maximum	95 %
Protection class IP	IP20
Design, dimensions and weight	
Module format	USB V2.0 adapter
Width	58 mm
Height	26 mm
Depth	105 mm
Net weight	365 g
Mounting type 35 mm DIN rail mounting	No
Product properties, functions, components general	
Number of plug-in cards in the same design can be plugged in per PC station	1
Number of modules note	-
Product functions Diagnosis	
Product function Port diagnostics	Yes
Standards, specifications, approvals	
Standard	
• for EMC	2004/108/EC
• for safety of CSA and UL	cULus, UL 60950-1, CSA22.2
• for emitted interference	EN 61000-6-3, EN 61000-6-4
• for interference immunity	EN 61000-6-1, EN 61000-6-2
Verification of suitability	
• CE mark	Yes
• C-Tick	Yes
Accessories	
Accessories	-

Ordering data**Article No.****PC adapter USB A2****6GK1571-0BA00-0AA0**

for connecting a PG/PC or Notebook to PROFIBUS or MPI; USB cable included in scope of delivery

Overview

The SIMATIC Basic Panel, Comfort Panel and Mobile Panel offer HMI functionality for the control systems:

- SIMATIC S7
- Non-Siemens controllers:
 - Allen Bradley
 - Mitsubishi
 - Modicon
 - Omron

For more detailed information, refer to the WinCC (TIA Portal) user manual, the "Windows-based systems communication" manual, or the WinCC (TIA Portal) online help.

OPC communication and HTTP communication are offered for all Panels with an integrated Ethernet interface. Both OPC and HTTP communication can be used in parallel with the process links to SIMATIC S7 or non-Siemens PLCs.

Note:

Interface options for HMI devices: See the individual device descriptions.

OPC communication

OPC Data Access is an open standard for exchanging both local and remote variables between various applications via Industrial Ethernet.

HTTP communication for variable exchange between SIMATIC HMI systems

Communication based on HTTP message frames enables variables to be exchanged between SIMATIC HMI systems.

Communication standard	SIMATIC HMI			
Version	Comfort Panel	Mobile Panel 177 PN MP 177	Mobile Panel 277	WinCC Runtime Advanced
<i>OPC Data Access V2.05a + OPC UA Data Access V1.01 + OPC Data Access XML V1.00</i>				
OPC DA client (COM/DCOM)	–	–	–	•
OPC DA server (COM/DCOM)	–	–	–	•
OPC UA DA client	•	–	–	•
OPC UA DA server	•	–	–	–
<i>HTTP communication for variable exchange between SIMATIC HMI systems</i>				
HTTP client	•	•	•	•
HTTP server	•	•	•	•

- System interface possible
- System interface not possible

PROFIBUS

System interfaces for SIMATIC HMI

System interfaces with WinCC (TIA Portal)

SIMATIC S7

Overview

The following types of interface are differentiated in respect of the link between the SIMATIC Panels and SIMATIC S7 controllers:

- **PROFINET interface:**
Coupling of SIMATIC Panel to SIMATIC S7 controllers via Industrial Ethernet TCP/IP using the integrated PROFINET interface of the CPU or, alternatively, a PROFINET interface module.
- **MPI/PROFIBUS interface:**
Coupling of SIMATIC Panel to SIMATIC S7 controllers via MPI/PROFIBUS using the integrated MPI/PROFIBUS interface of the CPU or the integrated PPI interface of the CPU in the case of S7-200 or, alternatively, a PROFIBUS interface module in the case of S7-1200, S7-1500, S7-300 and S7-400.
- **PPI interface:**
Coupling of SIMATIC Panel to SIMATIC S7-200 via PPI network using the integrated PPI interface of the CPU

The maximum possible number of S7 connections of one CPU is determined by its performance capacity (see Catalog ST 70); from the point of view of SIMATIC Panel, the following restrictions apply:

- Basic Panel, Comfort Panel 4", Mobile Panel 177: max. 4 connections
- Comfort Panel 7" - 22": max. 8 connections
- Mobile Panel 277: max. 6 connections
- PC with WinCC Runtime Advanced: max. 8 connections

PPI interface

The PPI interface is a point-to-point connection between a SIMATIC Panel (PPI master) or alternatively a PG (PPI master) and an S7-200 (PPI slave).

MPI/PROFIBUS interface or PROFINET interface

The corresponding multipoint-enabled communication interfaces of SIMATIC Panels and SIMATIC S7 are used. The following are possible:

- Interface between one or more SIMATIC Panels (MPI master) and one or more S7-1200/S7-1500/S7-300/S7-400s or WinAC (MPI master) (possible network topology: MPI/PROFIBUS or Industrial Ethernet, TCP/IP)
- Interface between one or a number of SIMATIC Panels (MPI master) and one or a number of S7-200s (MPI slave)¹⁾ (possible network topology: PPI, MPI/PROFIBUS)

Unlike PPI connections, MPI connections are static connections that are set up during booting and then monitored.

The original format of a master/master link has been joined by a master/slave link, which has enabled integration of the S7-200 (except CPU 212).¹⁾

In principle this type of information exchange between SIMATIC Panels and SIMATIC S7 is independent of the network used, PPI, MPI/PROFIBUS or Industrial Ethernet: SIMATIC Panels are S7 clients and SIMATIC S7 CPUs are S7 servers.

¹⁾ With regard to restricted baud transmission rates for S7-200, see Catalog ST 70.

Overview (continued)

Controller	SIMATIC HMI				
	Basic Panel	Comfort Panel	Mobile Panel 177 DP ¹⁾ Mobile Panel 177 PN ¹⁾	Mobile Panel 277 ¹⁾	WinCC Runtime Advanced
Target hardware (PROTOCOL) (physics)					
<i>SIMATIC S7-200</i> ²⁾					
over Ethernet (TCP/IP) (MPI protocol) an max. 4 x S7-200	• ³⁾	•	• ³⁾	•	•
over MPI or PROFIBUS network (MPI-Protokoll) an max. 4 x S7-200	• ⁴⁾	• ⁶⁾	• ^{4) 6)}	• ⁶⁾	• ^{5) 6)}
over PPI network (MPI protocol) an max. 4 x S7-200	• ⁴⁾	–	•	–	–
over PPI network (PPI protocol) an max. 1 x S7-200	–	• ⁷⁾	• ⁷⁾	• ⁷⁾	• ^{5) 7)}

- System interface possible
- System interface not possible

¹⁾ Mobile Panel connection via special connecting cable and junction box (see Mobile Panel), see Manual for cable layout

²⁾ Controllers can be combined as desired

³⁾ Basic Panel PN and Mobile Panel 177 PN only

⁴⁾ Not Basic Panel PN or Mobile Panel 177 PN

⁵⁾ Connection via integrated MPI/PROFIBUS interface; in the case of a standard PC, a communications processor (CP) is to be used (e.g. CP 5611 A2)

⁶⁾ Only on passive S7-200; OP 77B auch an aktive S7-200

⁷⁾ Can be interfaced via PPI to max. 1 x S7-200 (PPI); network operation (parallel PG, etc.) is possible

Note:

Detailed information regarding cable layout can be found in the online help for WinCC.

PROFIBUS

System interfaces for SIMATIC HMI

System interfaces with WinCC (TIA Portal)

SIMATIC WinCC (TIA Portal) Runtime

Overview

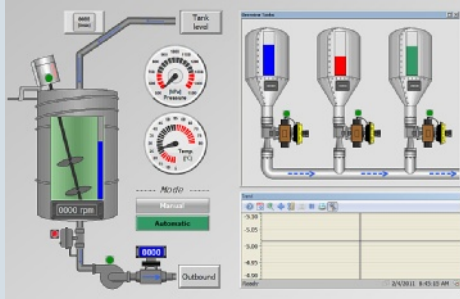

SIMATIC WinCC Runtime Advanced visualization software

- PC-based HMI solution for single-user systems directly at the machine
- Basic package for visualization, reporting and logging, user administration, can be expanded flexibly with VB scripts
- Basic package expandable by means of option packages
- Can be integrated into automation solutions based on TCP/IP networks
- Expanded service concepts with remote operation, diagnostics and administration over the intranet and Internet in combination with email communication

SIMATIC WinCC Runtime Professional visualization software

- PC-based operator control and monitoring system for visualization and operator control of processes, production flows, machines and plants in all sectors – from the simple single-user station through to distributed multi-user systems and cross-location solutions with web clients. WinCC Runtime Professional is the information hub for corporation-wide vertical integration.
- Industry-standard functions for signaling and acknowledging events, archiving of messages and measured values, logging of all process and configuration data, user administration, can be expanded flexibly with VB and C scripts
- Basic package expandable by means of option packages
- Also included are APIs for the Runtime to utilize the open programming interfaces

Overview**Communication – SIMATIC WinCC Runtime Advanced**

WinCC Advanced is an open visualization system and offers the option of connecting the most diverse control systems.

Number of connectable controllers

WinCC Advanced permits the parallel coupling of up to 8 controllers.

Connection to third-party controllers

The following "Coupling overview" table lists third-party protocols and controllers which are directly supported by WinCC Advanced. Generally it is also possible to connect third-party controllers via OPC (OLE for Process Control).

Current notes and information about OPC servers from many different suppliers can be found at: <http://www.opcfoundation.org/>

WinCC Advanced supports the standards:

- OPC Data Access 2.05a
- OPC UA Data Access 1.01
- OPC XML Data Access 1.00 (client via DCOM/XML gateway)

Coupling overview for WinCC Runtime Advanced

Protocol	Description	PC interface
<i>SIMATIC S7</i>		
MPI, PROFIBUS (S7 communication)	Channel for communication via MPI, PROFIBUS with max. 8 x SIMATIC S7 controllers S7-1200 with CM 1243-5 (DP master), S7-1500 S7-300, S7-400, S7-200 (passive S7-200 only)	CP 5611 A2 CP 5612 CP 5621 CP 5622 CP 5711 CP 5613 A2 CP 5613 A3 CP 5623
PPI (PPI protocol)	Channel for communication via PPI with 1 x SIMATIC S7-200 (network operation, e.g. parallel PG possible)	CP 5611 A2 CP 5612 CP 5621 CP 5622 CP 5711 CP 5613 A2 CP 5613 A3 CP 5623
Software interface (S7 communication)	Channel for communication via software interface with WinAC	
<i>SINUMERIK ¹⁾</i>		
MPI (S7 communication)	Channel for communication via MPI with SINUMERIK 840D sl	CP 5611 A2 CP 5612 CP 5621 CP 5622 CP 5711 CP 5613 A2 CP 5613 A3 CP 5623

¹⁾ "SINUMERIK Operate WinCC RT Advanced" license required; for further information, see NC 60 Catalog.

PROFIBUS

System interfaces for SIMATIC HMI

System interfaces with WinCC (TIA Portal)

WinCC Runtime Communication

Overview (continued)

Communication – SIMATIC WinCC Runtime Professional

WinCC Professional is an open process visualization system and offers the option of connecting the most diverse control systems.

Released communication software

Only communication software with the listed (or higher) product versions should be used. Corresponding SIMATIC NET upgrades are available for the upgrading of older versions.

Number of connectable controllers

With CP 1613/CP 1623, a maximum of 64 S7 controllers can be connected via Industrial Ethernet; with CP 5612/CP 5622 a maximum of 8, and with CP 5613 A3 a maximum of 44 S7 controllers can be connected via PROFIBUS. With approx. 10 or more controllers, the use of Industrial Ethernet is recommended.

Client-server communication

Communication between the clients and the server is implemented using the TCP/IP protocol. The construction of a separate PC-LAN is recommended. For small projects with correspondingly small message frame advent, a SIMATIC NET Industrial Ethernet can be used for both process communication (WinCC/server ↔ PLC) and for PC-PC communication (WinCC/client ↔ WinCC/server)

Connection to third-party controllers

The following "Coupling overview" table lists third-party protocols and controllers which are directly supported by WinCC Professional. Generally it is also possible to connect third-party controllers via OPC (OLE for Process Control).

Current notes and information about OPC servers from many different suppliers can be found at: <http://www.opcfoundation.org/>

WinCC Professional supports the standards:

- OPC Data Access 2.05a
- OPC Data Access 3.00
- OPC UA Data Access 1.01
- OPC XML Data Access 1.00
- OPC HDA 1.20
- OPC A&E 1.10

Coupling overview for WinCC Runtime Professional

Protocol	Description	PC interface
SIMATIC S7		
SIMATIC S7	Protocol Suite with channel units for communication with SIMATIC S7 via <ul style="list-style-type: none"> • Ethernet TCP/IP (S7 communication) to S7-1200, S7-1500, S7-300, S7-400 • MPI, PROFIBUS (S7 communication) to S7-1200 with CM 1243-5 (DP master), S7-1500, S7-300, S7-400 • Software interface (S7 communication) to Win AC 	CP 5612 CP 5622 CP 5711 CP 5613 A3 CP 5623

Communications examples

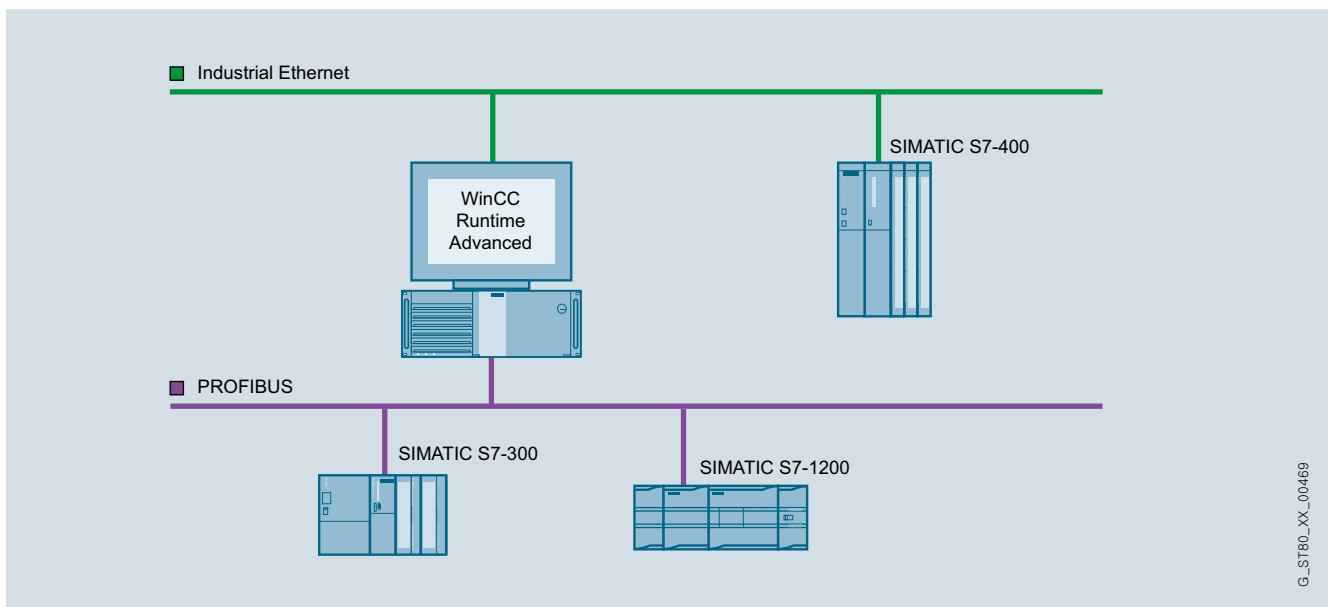

WinCC Runtime Advanced single-user system

G_ST80_XX_00469

Overview (continued)

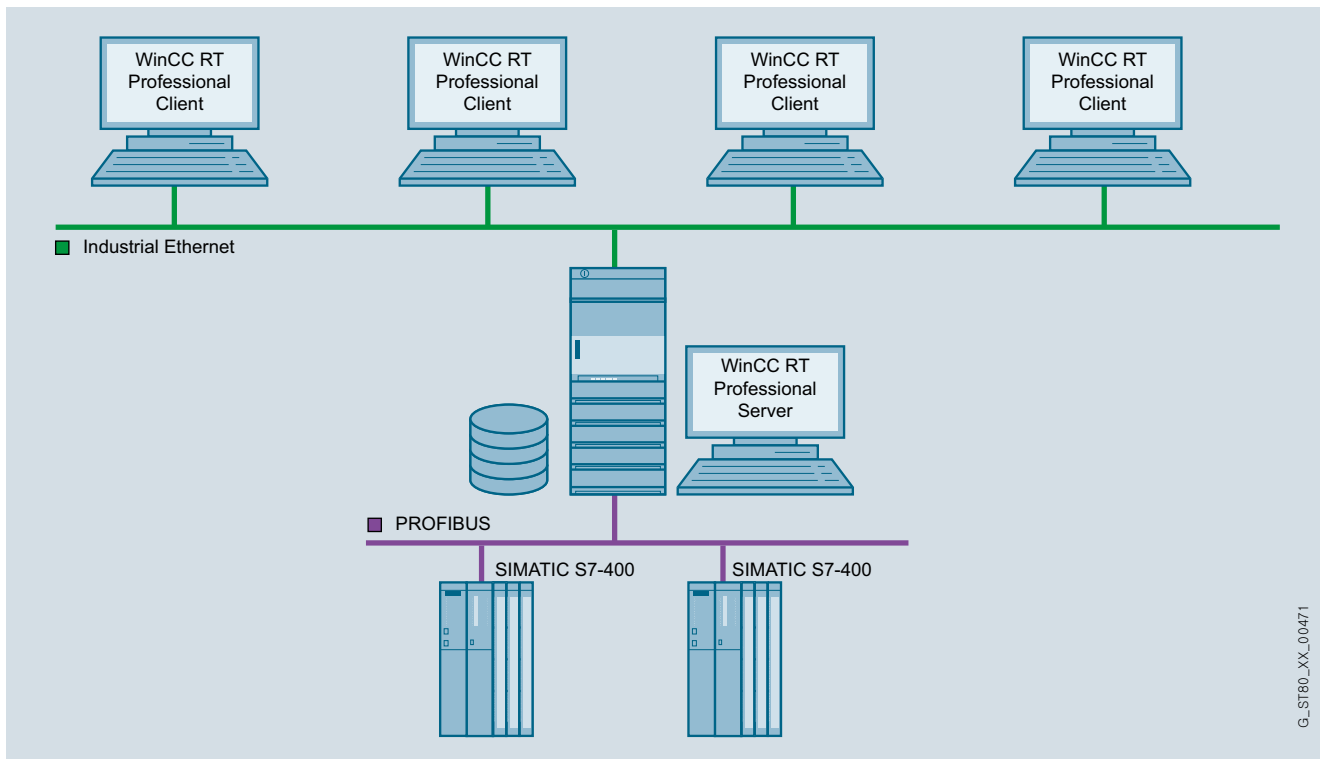

G_STB0_XX_00471

WinCC Runtime Professional multi-user system with operable Server

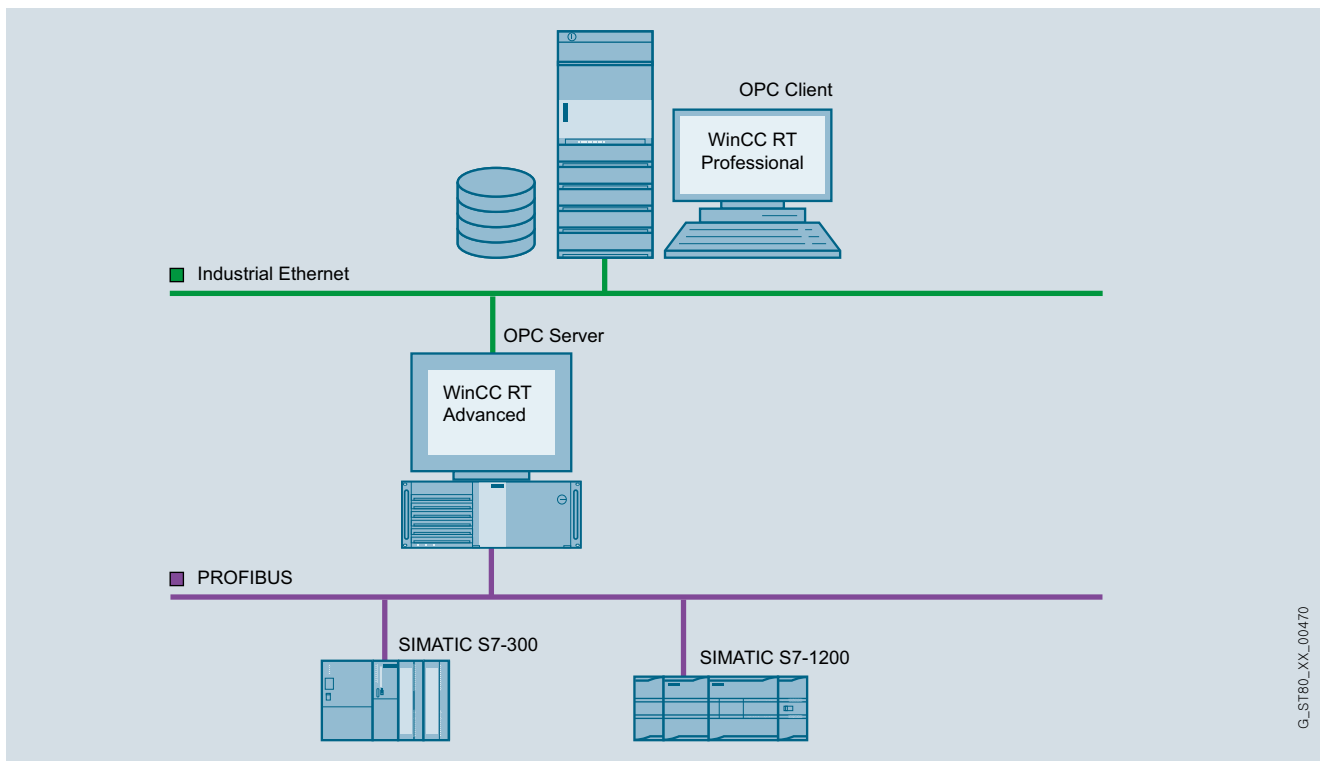

G_STB0_XX_00470

OPC coupling

PROFIBUS

System interfaces for SIMATIC HMI System interfaces with WinCC flexible

SIMATIC WinCC flexible RT

Overview

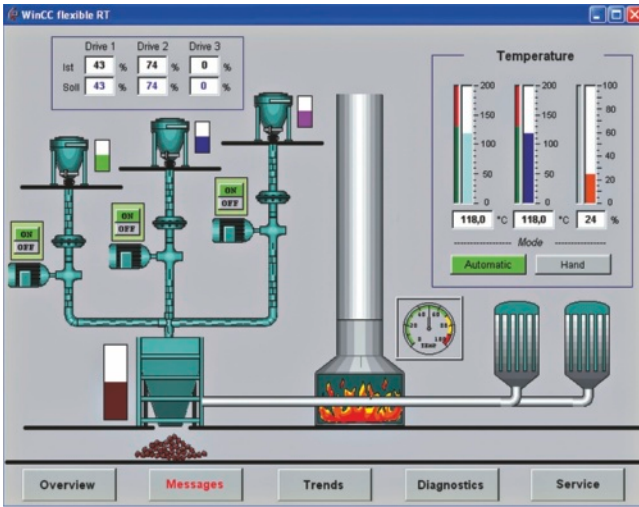

PC-based visualization software for single-user systems directly at the machine.

- Runs under Windows XP Professional and Windows 7 Professional, Ultimate, Enterprise
- Current version: SIMATIC WinCC flexible 2008 SP3 Runtime

SIMATIC WinCC flexible Runtime is configured with the SIMATIC WinCC flexible Advanced configuration software.

Benefits

- Optimum price/performance ratio thanks to individually scalable system functionality
- Functions for all visualization tasks: Operator functions, graphical and trend displays, signaling system, log system, archiving (option), recipe management (option), Audit Trail (option), process fault diagnostics (option)
- Flexible runtime functionality thanks to Visual Basic scripts
- Innovative service concepts with remote operation, diagnostics and administration via intranet and Internet as well as e-mail communication to increase availability (option)
- Support for simple distributed automation solutions based on TCP/IP networks at the machine level (option)

Application

SIMATIC WinCC flexible Runtime is the high-performance visualization software for simple visualization tasks at machine level. It can be used as a single-user solution for all automation applications in factory automation, process automation and building services automation.

SIMATIC WinCC flexible Runtime can be used in combination with the following operator panels:

- SIMATIC Panel PCs
 - PC IL 70/77
 - Microbox 420
 - Panel PC 477
 - Panel PC 577
 - Panel PC 670/677
 - Panel PC 870/877
- SIMOTION Panel PCs
 - P012, P015
 - PCR, PCR-Touch
- SINUMERIK Panel PCs
 - HT8; OP08T
 - OP010, OP012, OP015
 - TP012, TP015, OP015A
- Standard PCs with resolutions (W x H in pixels) of:
 - 4:3 format: 640 x 480, 800 x 600, 1 024 x 768, 1 280 x 1 024, 1 600 x 1 200
 - Widescreen format: 800 x 480, 1 280 x 800, 1 366 x 768, 1 440 x 900, 1 680 x 1 050, 1 920 x 1 080, 1 920 x 1 200, 1 980 x 1 080

Design

SIMATIC WinCC flexible Runtime is available as a software package with 128, 512, 2048 or 4096 PowerTags. The term PowerTags is used exclusively to identify process variables and range pointers that have a process link to the controller. Variables without process link, constant limit values of variables, and messages (up to 4000 bit-triggered messages) are also available for additional system performance.

The range of functions of WinCC flexible Runtime includes the centralized HMI components for visualizing and reporting, and it can be expanded to suit requirements and costs by using optional packages.

SIMATIC WinCC flexible Runtime is configured with the SIMATIC WinCC flexible Advanced configuration software.

Function

Visualization via Windows-compliant operator interface

made up of parameterizable screen objects and image blocks created on a project-specific basis:

- Numeric and alphanumeric input/output fields
- Static text and graphic display plus vector graphics
- Dynamizable graphics from HMI symbol library
- Bar graph, trend curve graph with scroll and zoom function as well as read line
- Signal-specific text and graphic lists
- Buttons and switches for operator-process communication
- Editing fields for process values (signals)
- Analog display, slider as example for further screen objects
- Project-specific image blocks created from system basic objects
- Graphic displays for various standard graphic formats, e.g. bitmaps, .jpg, .wmf

Alarms and messages

- Discrete alarms and analog alarms as well as event-driven Alarm-S/Alarm-D message procedure with SIMATIC S7 and SIMOTION
- Freely-definable message classes for definition of acknowledgment response and display of message events

Logging of alarms and process values ¹⁾

- Archiving in files (e.g. CSV or TXT file) and Microsoft SQL databases
- Online evaluation of process value archives and alarm logs
- Evaluation of process value archives and alarm logs using standard Microsoft tools such as Excel

Recipes ¹⁾

- Generation of data records for machine or production data
- Display or entry of data records via a configurable screen object or via process images when distributed within the project
- Transmission of data records from or to the PLC
- Import/export for data records from/to CSV files

Documentation of process data, alarm events and recipes

- Time- or event-driven report output
- User-definable layout

Flexible expansion of system function

- thanks to Visual Basic Script

Language support for multilingual projects

- Up to 16 online languages (incl. Asian and Cyrillic)
- Language-dependent texts and graphics
- Language selection during runtime

User-oriented access protection according to requirements of regulated sectors

- Authentication with user ID and password
- User-group-specific rights
- Central system-wide user administration based on SIMATIC Logon ¹⁾
- Monitoring of changes by operators in runtime operation ¹⁾
- Recording of operator actions in an Audit Trail ¹⁾

PLC link for a wide variety of PLCs on-board

- Simultaneous connection using several protocols: OPC Client or SIMATIC HMI HTTP protocol are additive, i.e. can be used in conjunction with other PLC links
- Communication via native drivers and standard OPC channel

Open communication between HMI systems and with higher-level systems ¹⁾

- OPC server
- Sm@rtAccess for communication between HMI systems based on Ethernet networks, or via the intranet/Internet:
- Read and write access to variables; WinCC flexible Runtime or SIMATIC Panels make data (variables) available to other SIMATIC HMI systems or Office applications.
- A SIMATIC HMI system can be used to control or monitor another system remotely; entry level for client/server configurations for distributed operator stations or for solutions with headend or control room.

Sm@rtService for remote control, diagnostics and administration via intranet and Internet ¹⁾

- Display and control of process images on remote PC or Panel
- Sending of e-mails on demand or event-driven
- System diagnostics visualized via device-specific HTML pages

¹⁾ Option for SIMATIC WinCC flexible Runtime; runtime licenses must be purchased separately. For further information, refer to "WinCC flexible options".

System requirements	WinCC flexible Runtime
Operating system	Windows XP Professional SP3 (32 bit) Windows XP Embedded ¹⁾ Windows 7 Professional / Ultimate / Enterprise (32 bit and 64 bit)
Processor ⁴⁾	
• Minimum	Windows XP: 300 MHz Windows 7: 1 GHz
• Recommended	Windows XP: ≥ Pentium III, 500 MHz Windows 7: ≥ 1 GHz
Graphics	
• Minimum	SVGA
• Resolution	640 x 480 to 1 600 x 1 200 or 800 x 480 to 1 980 x 1 080
RAM ²⁾	
• Minimum	Windows XP: 128 MB Windows 7: 1 GB
• Recommended	Windows XP: ≥ 512 MB Windows 7: ≥ 1 GB
Hard disk (free memory space) ³⁾	≥ 250 MB

¹⁾ Only for enabled platforms (e.g. Panel PC 477). You can get information from your Siemens contact.

²⁾ RAM requirements are determined primarily by the size of the graphics used.

³⁾ Without taking archives into account. In addition to the space needed by WinCC flexible, Windows also requires space on the hard disk; e.g., for the swap file. The following formula has proven itself in the past: The size of the swap file = 3 x the size of the RAM. For further information, refer to your Windows documentation

⁴⁾ More powerful systems (Pentium 4 and higher) may be required in order to use options

PROFIBUS

System interfaces for SIMATIC HMI System interfaces with WinCC flexible

SIMATIC WinCC flexible RT

Integration

SIMATIC WinCC flexible Runtime supports linking to:

Protocol	PC interfaces
SIMATIC S7 via PPI	
S7-200	CP 5611 A2 ²⁾ CP 5612 CP 5621 ¹⁾ CP 5622 CP 5613 A2 CP 5614 A2 CP 5623 CP 5624 CP 5711 PC/PPI adapter ³⁾
SIMATIC S7 via MPI	
S7-200 (except CPU 212) ⁴⁾	CP 5611 A2 ²⁾ CP 5612
S7-300	CP 5621 ¹⁾ CP 5622
S7-400	CP 5613 A2 CP 5614 A2
WinAC Basis (V3.0 and higher)	CP 5623 CP 5624
WinAC RTX	CP 5711 PC adapter USB A2 ⁶⁾ Teleservice V6.1
SIMATIC S7 via PROFIBUS DP ⁵⁾	
S7-215 ⁴⁾	CP 5611 A2 ²⁾ CP 5612
S7-300 CPUs with integr. PROFIBUS interface	CP 5621 ¹⁾ CP 5622
S7-300 with CP 342-5	CP 5613 A2 CP 5614 A2
S7-400 CPUs with integr. PROFIBUS interface	CP 5623 CP 5624
S7-400 with CP 443-5 or IM 467	CP 5711
WinAC Basis (V3.0 and higher)	
WinAC RTX	
SIMATIC S7 via integrated interface	
WinAC Basis (V2.0 and higher)	Internal system interface
WinAC RTX	
SIMOTION ⁸⁾	
SINUMERIK ⁹⁾	

- ¹⁾ WinCC flexible Runtime is passive (DP slave); the function block required for the link is included in the scope of delivery of WinCC flexible
- ²⁾ For Microbox 427 and Panel PC 477/577/677 via internal MPI/DP interface
- ³⁾ Only point-to-point to S7-200; no configuration download, operating systems: Windows XP; Article number: 6ES7901-3CB30-0AX0
- ⁴⁾ Constraint with regard to baud rate for S7-200; see Catalog ST 70
- ⁵⁾ WinCC flexible RT is active; communication with S7 functions
- ⁶⁾ Only point-to-point to S7-300/-400; no configuration download, operating systems: Windows 2000/XP and higher; article number: 6GK1571-0BA00-0AA0 (USB)
- ⁷⁾ For Microbox 427 and Panel PC 477/577/677/877 via internal Ethernet interface
- ⁸⁾ For further information, see Catalog PM 10
- ⁹⁾ "SINUMERIK HMI copy license OA" option required; for further information, see Catalog NC 60

Application note

In parallel with each and every PLC link, WinCC flexible Runtime supports the use of the OPC Client channel; this enables, for example, connection to an SNMP OPC Server for the purpose of visualizing the data stored there. The SNMP OPC Server provides a means of monitoring network components of any type (e.g. switches) which support the SNMP protocol. For further information, see Catalog IK PI.

Note:

For further information, see "HMI devices/System interfaces"

Integration (continued)

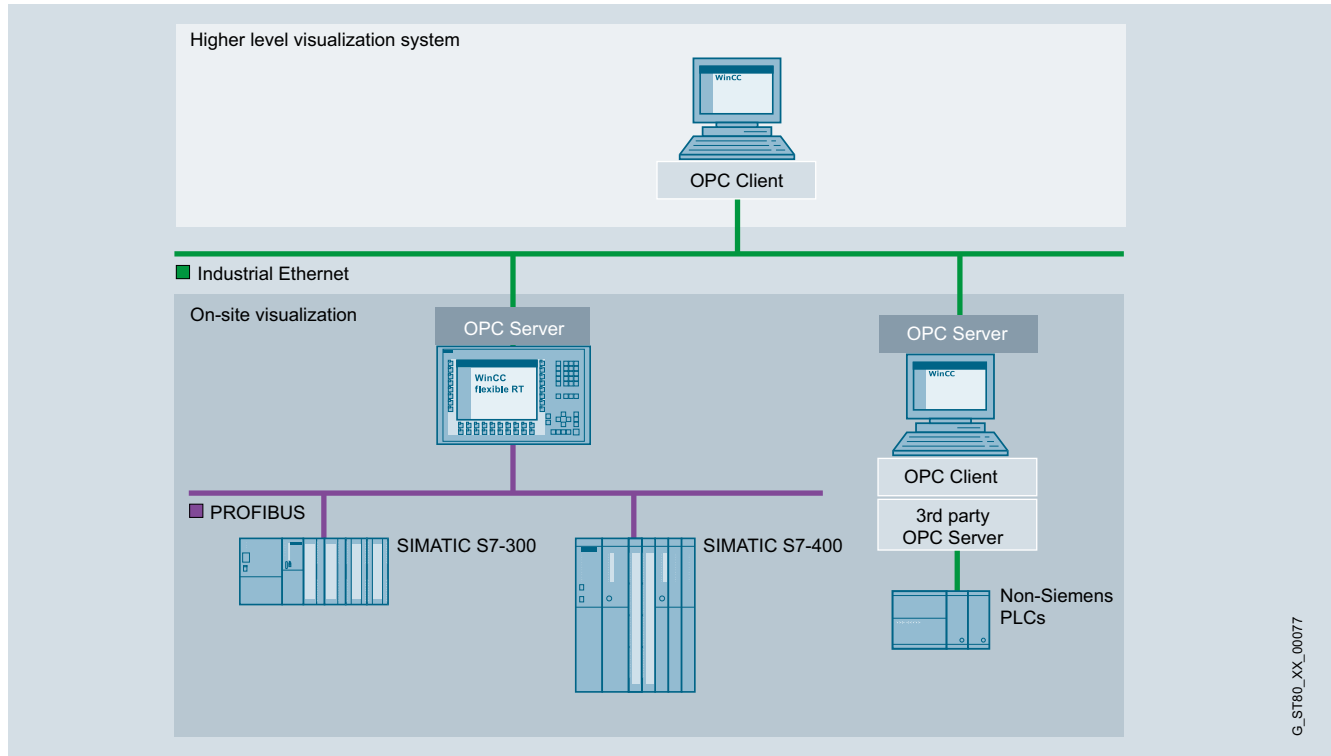

SIMATIC WinCC flexible Runtime application example

Technical specifications

Type	SIMATIC WinCC flexible Runtime
	The specifications are maximum values
Displays	500
• Fields per screen	400
• Variables per screen	400
• Static text	30 000
• Graphics objects	2 000
• Complex objects per display (e.g. bars)	40
• Trends	800
• Graphics lists ¹⁾	500
• Text lists ¹⁾	500
• Number of entries in symbol tables	3 500
Variables	4 096 ³⁾
Messages bit-triggered / analog	4 000 / 500
• Message text (number of characters)	80
• Number of process values per message	8
• Size of message buffer	1 024
• Pending message events	500
Archives ⁴⁾	100
• Archivable data	Process data, messages
• Max. number of entries per archive (incl. all archive segments)	500 000
• Archive types	Short-term archive, sequence archive (max. 400 per archive)
• Data storage format	CSV (Comma Separated Variable), RDB (Runtime Data Base), interface to MS SQL database
Recipes ⁴⁾	1 000
• Elements per recipe	2 000 ³⁾
• Data records per recipe	5 000 ²⁾

Type	SIMATIC WinCC flexible Runtime
	The specifications are maximum values
Password protection	
• User rights	32
• Number of user groups	50
Visual Basic scripts	200
Online languages, max.	16
Communication	
SIMATIC S7 MPI interface/ PROFIBUS DP interface	
• Number of connectable stations, max.	Depending on the scope of the configuration (communication) from the point of view of WinCC flexible Runtime, as many as 8 connections are possible
SIMATIC S7 PPI interface	
• Number of connectable stations, max.	1 from viewpoint of WinCC flexible Runtime
SIMATIC S5 PROFIBUS DP interface	
• Number of connectable stations, max.	1 from viewpoint of WinCC flexible Runtime
Multi-protocol operation	Yes, OPC Client or SIMATIC HMI HTTP protocol are additive, i.e. can be used in conjunction with other PLC links

¹⁾ Together only 500 text and graphics lists

²⁾ Dependent on memory medium used

³⁾ Dependent on number of licensed PowerTags

⁴⁾ Option for SIMATIC WinCC flexible Runtime. For further information, refer to "WinCC flexible options".

PROFIBUSSystem interfaces for SIMATIC HMI
System interfaces with WinCC flexible

SIMATIC WinCC flexible RT

Ordering data**Article No.****Article No.****SIMATIC WinCC flexible 2008 Runtime**

for PC systems; incl. SW for PC systems options ¹⁾ Single license, on CD-ROM incl. licensing, for:

- 128 PowerTags (RT 128)
- 512 PowerTags (RT 512)
- 2 048 PowerTags (RT 2048)
- 4 096 PowerTags (RT 4096)

6AV6613-1BA51-3CA0
6AV6613-1DA51-3CA0
6AV6613-1FA51-3CA0
6AV6613-1GA51-3CA0

Power Packs**SIMATIC WinCC flexible 2008 Runtime**

Single license, only license key for PowerTags, from

- 128 to 512 PowerTags
- 128 to 2 048 PowerTags
- 512 to 2 048 PowerTags
- 128 to 4 096 PowerTags
- 512 to 4 096 PowerTags
- 2 048 to 4 096 PowerTags

6AV6613-4BD01-3AD0
6AV6613-4BF01-3AD0
6AV6613-4DF01-3AD0
6AV6613-4BG01-3AD0
6AV6613-4DG01-3AD0
6AV6613-4FG01-3AD0

Updates**SIMATIC WinCC flexible 2008 Runtime Update 2008, 2008 SP1, 2008 SP2 -> 2008 SP3**

6AV6613-1XA51-3CU8

Upgrades**SIMATIC WinCC flexible 2004/2005/2007 Runtime to SIMATIC WinCC flexible 2008 Runtime**

Upgrade to SIMATIC WinCC flexible Runtime 2008 PowerTags incl. Runtime Options for:

- WinCC flexible /Archives
- WinCC flexible /Recipes
- WinCC flexible /Audit
- WinCC flexible /Sm@rtAccess
- WinCC flexible /Sm@rtService
- WinCC flexible /OPC server
- WinCC flexible /ProAgent

6AV6613-1XA51-3CE0

Upgrade of the SIMATIC WinCC flexible Panel options:

- WinCC flexible /Audit for SIMATIC Panel
- WinCC flexible /Sm@rtAccess for SIMATIC Panel
- WinCC flexible /Sm@rtService for SIMATIC Panel
- WinCC flexible /OPC server for SIMATIC Multi Panel
- WinCC flexible /ProAgent for SIMATIC Multi Panel

6AV6618-7XX01-3AF0

Documentation (must be ordered separately)**User Manual WinCC flexible Runtime**

- German
- English
- French
- Italian
- Spanish

6AV6691-1BA01-3AA0
6AV6691-1BA01-3AB0
6AV6691-1BA01-3AC0
6AV6691-1BA01-3AD0
6AV6691-1BA01-3AE0

User Manual WinCC flexible Communication

- German
- English
- French
- Italian
- Spanish

6AV6691-1CA01-3AA0
6AV6691-1CA01-3AB0
6AV6691-1CA01-3AC0
6AV6691-1CA01-3AD0
6AV6691-1CA01-3AE0

SIMATIC Manual Collection

6ES7998-8XC01-8YE0

Electronic documentation, on DVD
5 languages (English, French, German, Italian and Spanish);
contains: all currently available user manuals, device manuals and communication manuals for SIMATIC HMI

¹⁾ Runtime licenses for WinCC flexible Runtime options must be purchased separately for each target system.

More information

Additional information is available in the Internet under:

<http://www.siemens.com/wincc-flexible>

Note:

Do you need a specific modification or option for the products described here? You will find information about the Open Platform Program for the creation of user-specific functions and controls for WinCC flexible under "Customized Products".

Overview

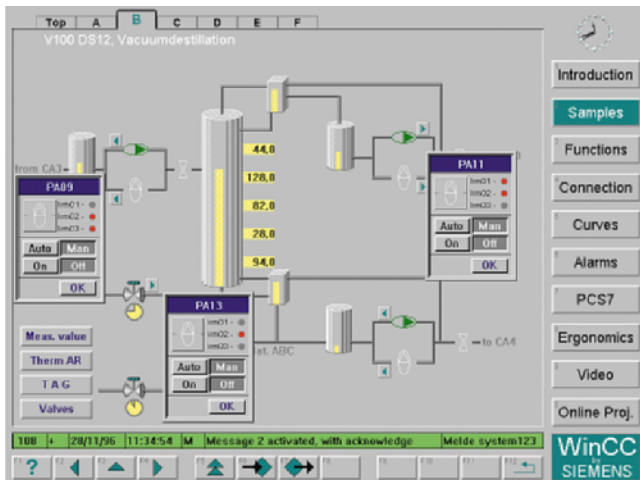

- PC-based operator control and monitoring system for visualizing and operating processes, production flows, machines and plants in all sectors – from the simple single-user station through to distributed multi-user systems with redundant servers and cross-location solutions with Web clients. WinCC is the information hub for corporation-wide vertical integration.
- The basic system configuration (WinCC basic software) includes industry-standard functions for signaling and acknowledging events, archiving of messages and measured values, logging of all process and configuration data, user administration and visualization.
- The WinCC basic software forms the core of a wide range of different applications. Based on the open programming interfaces, a wide range of WinCC options (from Siemens Industry Automation) and WinCC add-ons have been developed (by Siemens-internal and external partners).
- WinCC can be operated with every PC that meets the given HW requirements. The SIMATIC IPC product range is available in particular for the industrial use of WinCC systems. SIMATIC IPCs impress with their powerful PC technology, are designed for round-the-clock operation, and can be operated in both office areas and harsh industrial environments.

Current versions:

SIMATIC WinCC V7.3

Ablauffähig unter:

- Windows 7 SP1 (32 / 64 bit) Professional, Enterprise, Ultimate
- Windows 8.1 (32 / 64 bit) Professional, Enterprise
- Windows 2008 Server SP2 (32 bit) Standard
- Windows 2008 Server R2 SP1 (64 bit) Standard
- Windows Server 2012 R2 (64 bit) Standard
contains the Microsoft SQL Server 2008 R2 SP2 (32 bit)

SIMATIC WinCC V7.2

Executable with:

- Windows 7 SP1 (32 / 64 bit) Professional, Enterprise, Ultimate
- Windows XP Professional SP3
- Windows Server 2003 SP2, Standard
- Windows Server 2008 SP2 (32 bit) Standard
- Windows Server 2008 R2 SP1 (64 bit) Standard
contains the Microsoft SQL Server 2008 R2 SP1 (32 bit)

SIMATIC WinCC V7.0 SP3

Executable with:

- Windows 7 SP1 (32 / 64 bit) Professional, Enterprise, Ultimate
- Windows XP Professional SP3
- Windows Server 2003 SP2 and Windows Server 2003 R2 SP2 Standard
- Windows Server 2008 SP2 (32 bit) Standard
- Windows Server 2008 R2 SP1 (64 bit) Standard
contains the Microsoft SQL Server 2005 SP4
- Use in virtual environments – for additional information, see <http://support.automation.siemens.com/WWW/view/en/49370459>

PROFIBUS

System interfaces for SIMATIC HMI

System interfaces with WinCC

SIMATIC WinCC

Benefits

- All-purpose
 - Solutions for all sectors
 - Multilingual for worldwide usage
 - Can be integrated into all automation solutions
- All HMI functions on board
 - User administration
 - Operator control and monitoring
 - Reporting, acknowledging, and archiving of events
 - Acquisition, compression and archiving of measured values (incl. long-term backup)
 - Logging and documenting of process and configuration data
- Can be configured simply and efficiently
 - Configuration wizards let the user focus on the essentials
 - In the picture by means of cross-reference lists and screen property displays
 - Configuration of multilingual applications
 - Configuring tool for configuring bulk data
- Universally scalable
 - Expandable from single station to client-server configurations
 - Increased availability by means of redundant servers
 - Process visualization via the web with the WinCC WebNavigator
- Open standards for simple integration
 - Powerful real-time database Microsoft SQL Server 2008 R2 SP1 (32 bit)
 - Open for application modules with ActiveX controls
 - Visual Basic for Applications for individual expansions
 - OPC for cross-vendor communication
- Process visualization with Plant Intelligence
 - Integrated high-performance Historian on the basis of the Microsoft SQL Server 2008 R2 SP1 (32 bit)
 - Integrated evaluation functions for the online analysis (statistical process control)
 - Production optimization with the help of diverse options
- Expandable using options and add-ons
 - Options for scalable configurations
 - Options for increasing the availability
 - Options for IT & business integration
 - Options for SCADA expansions
 - Options for validation in accordance with FDA 21 CFR Part 11
 - Options for the use of telecontrol protocols
- Part of Totally Integrated Automation
 - Direct access to the tag and message configuration of the SIMATIC control system
 - Integrated diagnostic functions for increasing productivity
 - Options for the use of telecontrol protocols

New in V7.2

- Expansion into Graphic Designer
 - Know-how protection by means of password protection for PDL images and image blocks
- Unicode support
 - WinCC SETUP in 5 languages / up to 9 installed languages
 - Individual language selection for engineering and runtime, regardless of the language settings in the operating system
- Simplified configuration of the Tag Management by means of the innovative WinCC Configuration Studio
 - Configuration options similar to those in Excel
 - Simplified tags / structure tag management
- New communication channels
 - Communication channel to new CPU (S7-1200 / S7-1500) (absolute address only, no CPU alarming support)
 - Introduction of the OPC UA server (DA, HDA)
- Expansion into archive system
 - New archive recording (day, week, year)
 - New archiving methods (difference)

and more ...

Application

SIMATIC WinCC is designed for visualization and operation of processes, manufacturing cycles, machines and plants. With its powerful process interface, especially to the SIMATIC family, and the secure data archiving, WinCC enables highly available solutions for the process control.

The sector-neutral basic system enables universal usage in all automation applications. Sector-specific solutions can, for example, be implemented using WinCC options (e.g. FDA options for the pharmaceutical industry) and sector-specific add-ons (e.g. for the water industry).

Design

SIMATIC WinCC is available as a complete package and as a runtime package with 128, 512, 2048, 8192, 65536, 102400, 153600, 262144 PowerTags¹⁾. PowerTags are data points that are connected to controllers or other data sources over a WinCC channel. Up to 32 alarms can be obtained from one data point. Moreover, internal tags without coupling are available for additional system performance. In addition WinCC also contains 512 archive tags. Individual archive licenses can be obtained for greater quantity structures.

Licenses for a multi-user configuration

The system software with the required number of PowerTags and additionally the option WinCC/Server must be installed on the WinCC server. In the basic configuration, an RT128 or RT client license is sufficient for the WinCC clients. In order to perform configuration on clients, an RC128 license is required. Remote configuration is possible if WinCC clients without their own project (UniClient) on the server project are configured.

¹⁾ V6: 128, 256, 1024, 8192, 65536 PowerTags

Function

The powerful configuration functions of SIMATIC WinCC contribute to a reduced engineering and training overhead and lead to a more flexible use of personnel and greater operational reliability. Whoever is familiar with Microsoft Windows can also operate the WinCC Explorer, the central switching point of WinCC.

In combination with other SIMATIC components, the system is also equipped with auxiliary functions such as process diagnostics and maintenance. All SIMATIC engineering tools work together in the configuration of the functions.

SIMATIC WinCC offers a complete basic functionality for process visualization and operation. To this end WinCC has a number of editors and interfaces that can be used to individually configure this functionality according to the respective application. Expansions of a WinCC station for control tasks are also possible with minimal engineering effort.

WinCC editors	Task or configurable runtime functionality
WinCC Explorer	Central project management for the quick access to all project data and central settings
WinCC Graphics Designer	Graphics system for user-defined visualization and operation via pixel-graphic objects
WinCC Alarm Logging	Signaling system for detecting and archiving events with display and control options according to DIN 19235; freely selectable message classes, message display and logging
WinCC Tag Logging	Process archiving for the acquisition, compression and storage of measured values, e.g., presentation in trend and table format as well as further processing
WinCC Report Designer	Reporting and logging system for time and event-controlled documentation of messages, operator inputs and current process data in the form of user reports or project documentation in an arbitrary layout
WinCC User Administrator	Tool for user-friendly administration of users and authorizations
WinCC Global Script	Processing functions with limitless functionality by means of the use of VBScript and ANSI-C

Interfaces

	Task or configurable runtime functionality
Communication channels	For communication with subordinate controls (SIMATIC protocols, PROFIBUS DP, PROFIBUS FMS, DDE and OPC server included in the scope of delivery)
Standard interfaces	For the open integration of other Windows applications via WinCC, WinCC-OLE-DB, ActiveX, OLE, DDE, OPC, etc.)
Programming ports	For the individual access to data and functions of WinCC and for the integration in user programs with VBA, VB Script, C-API (ODK), C-Script (ANSI-C)

Integration

Integration in company-wide solutions (IT and business integration)

WinCC is strictly based on Microsoft technology, which provides the greatest possible compatibility and integration ability. ActiveX and .net¹⁾ controls support technology-specific and industry-specific expansions. Cross-manufacturer communication is also a simple exercise. The reason: WinCC can be used as an OPC client and server, and in addition to access to current process values, it also supports standards such as OPC HDA (Historical Data Access), OPC Alarm & Events, and OPC XML Data Access.

Just as important: Visual Basic for Applications (VBA) for user-specific expansions of the WinCC Graphics Designer and Visual Basic Scripting (VBS) as an easy-to-learn, open runtime language. If desired, professional application developers can also use ANSI-C. And access to the API programming interfaces is really simple with the Open Development Kit ODK.

WinCC integrates a powerful and scalable historian function based on Microsoft SQL Server 2005 into the basic system. As a result, users have every possibility: from high-performance archiving of current process data, to long-term archiving with high data compression, through to a central information hub in the form of a company-wide process historian. With the help of the Central Archive Server option, this can be set up within the framework of a WinCC solution. Versatile clients and tools for evaluation, the open interfaces, and special options (Connectivity Pack, Connectivity Station, IndustrialDataBridge) provide the basis for effective IT and business integration.

If external networks are accessed, suitable protective measures (incl. IT security measures, such as network segmentation) should be taken in order to ensure safe operation of the system.

You can find more information on the topic of Industrial Security on the Internet at:

<http://www.siemens.com/industrialsecurity>

¹⁾ Only supported in WinCC V7.0 or higher

Integration in automation solutions

WinCC is an open process visualization system and provides the option to connect the most diverse control systems.

Approved communication software

Only communication software with the listed product versions (or higher) should be used. Corresponding SIMATIC NET upgrades are available for upgrading older versions.

Number of connectable controls

For the number of controls connectable via Industrial Ethernet CP 1613, the following applies to a message frame length of 512 bytes:

Type of connection	Number of nodes
SIMATIC S5 Ethernet Layer 4 + TCP/IP	Up to 60
SIMATIC S7 Protocol Suite	Up to 64
SIMATIC 505 Ethernet Layer 4 + TCP/IP	up to 60

Via PROFIBUS, a maximum of 8 controls can be connected with CP 5611, and a maximum of 44 controls with CP 5613. With approx. 10 or more controls, the usage of Industrial Ethernet is recommended.

PROFIBUS

System interfaces for SIMATIC HMI

System interfaces with WinCC

SIMATIC WinCC

Integration (continued)

Mixed operation with different controls

With their multi-protocol stack, the CP 1613 and CP 5613 communication processors allow parallel operation of two protocols, such as for the mixed operation of different controls, via a bus cable. WinCC supports the operation of two similar interface boards only in connection with the channels SIMATIC S5 Ethernet Layer 4 (2 x CP 1613), SIMATIC S7 Protocol Suite (2 x CP 1613, 2 x CP 5613) as well as PROFIBUS DP (4 x CP 5613; each CP 5613 max. 122 slaves). In addition to communication over industrial Ethernet CP 1613 or PROFIBUS CP 5613, one CP 5611 can be used in each case for communication with SIMATIC S7 via MPI.

Client-server communication

Communication between the clients and the server is via TCP/IP protocol. Setting up a separate PC LAN is recommended. For small projects with a correspondingly low incidence of message frames, SIMATIC NET Industrial Ethernet communication can be used for both process communication (WinCC/Server ↔ PLC) and PC-PC communication (WinCC/client ↔ WinCC/server).

Channel DLL PROFIBUS DP

In accordance with the PROFIBUS standard, DP/slaves are always permanently assigned to a DP master; i.e. a second WinCC station (DP/master) cannot access the same controls (DP/slave). This means that redundant operation of two WinCC stations is not possible using the PROFIBUS DP connection.

Connection to controls from other manufacturers:

OPC (OLE for Process Control) is recommended for the connection of controls from other manufacturers.

Current notes and information about OPC servers from various suppliers can be found at: <http://www.opcfoundation.org>

WinCC supports the standards:

- OPC Data Access 2.05a
- OPC Data Access 3.00
- OPC XML Data Access 1.00 (Connectivity Pack/Connectivity Station)
- OPC HDA 1.20 (Connectivity Pack/Connectivity Station)
- OPC A&E 1.10 (Connectivity Pack/Connectivity Station)
- OPC UA Client Data Access
- OPC UA Server Data Access, HDA (Connectivity Pack / Connectivity Station)

Connection overview

Protocol	Description
SIMATIC S7	
SIMATIC S7 Protocol Suite	Channel DLL for S7 functions via MPI, PROFIBUS or Ethernet Layer 4 + TCP/IP
SIMATIC S7-1200, S7-1500 (WinCC 7.2 or higher)	
SIMATIC S7-1200, S7-1500 Channel ¹⁾	Channel DLL for S7-1200 and S7-1500 communication
Cross-manufacturer	
OPC Client ^{2) 3)} for DA, XML DA	Channel DLL for OPC communication, WinCC can acquire data from OPC server applications.
OPC Server for DA, XML DA, A&E, HDA	Server applications for OPC communication; WinCC provides process data to OPC clients
OPC UA server for DA, HDA	Server applications for OPC UA communication
PROFIBUS FMS	Channel DLL for PROFIBUS FMS
PROFIBUS DP	Channel DLL for PROFIBUS DP
SIMOTION	Channel DLL for SIMOTION

¹⁾ WinCC version V7.2 or higher supports communication with S7-1200 / S7-1500 CPU.
Restrictions:
No symbolic address, type safe structure support (absolute address only)
No CPU alarming support

²⁾ Application note:
Parallel usage of the OPC client channel allows, for example, connection to an SNMP-OPC server for visualization of the data contained there. The SNMP OPC server enables monitoring of any network components (such as switches) that support the SNMP protocol. You can find more information under SIMATIC NET Communications Systems/SNMP OPC Server.

³⁾ WinCC V7.0 SP3 and later supports OPC UA (United Architecture) Client for DA.

Integration (continued)**Communication components for PG/PC for SIMATIC (for WinCC V7.0)**

PROFIBUS	SIMATIC S5 PROFIBUS FDL	SIMATIC S7 Protocol Suite	PROFIBUS DP	PROFIBUS FMS	Article No.
<i>WinCC – channel DLL</i>					
SIMATIC S5 PROFIBUS FDL Channel DLL for S5-FDL	•				Included in the basic package
SIMATIC S7 Protocol Suite Channel DLL for S7 functions		•			Included in the basic package
PROFIBUS DP Channel DLL for PROFIBUS DP			•		Included in the basic package
PROFIBUS FMS Channel DLL for PROFIBUS FMS				•	Included in the basic package
<i>Communication components for extension of the OS/OP</i>					
CP 5611 A2 PCI card (32-bit) for connecting a PG/PC to PROFIBUS or MPI (communication software included in WinCC basic package)		•			6GK1561-1AA01
CP 5612 ²⁾ PCI card (32-bit) for connecting a PG/PC to PROFIBUS (communication software included in WinCC basic package)		•			6GK1561-2AA00
CP 5621 PCI Express X1 card (32-bit) for connecting a PG/PC to PROFIBUS or MPI (communication software included in WinCC basic package)		•			6GK1562-1AA00
CP 5622 ²⁾ PCI Express X1 card (32-bit) for connecting a PG/PC to PROFIBUS (communication software included in WinCC basic package)		•			6GK1562-2AA00
CP 5711 USB Adapter for connecting a PG/PC to PROFIBUS or MPI (communications software included in the WinCC basic package)		•			6GK1571-1AA00
CP 5613 A2 PCI card (32-bit) for connecting a PC to PROFIBUS (S7-5613, DP-5613 or FMS-5613 communication software required)	•	•	•	•	6GK1561-3AA01
CP 5614 A2 PCI card (32-bit) for connecting a PC to PROFIBUS (communication software must be ordered separately)	•	•	•	•	6GK1561-4AA01
CP 5623 PCI Express X1 card (32-bit) for connecting a PG/PC to PROFIBUS or MPI (S7-5613 communication software or DP-5613 or FMS-5613 required)	•	•	•	•	6GK1562-3AA00

• System interface possible

1) See ordering data for SIMATIC NET upgrade package

2) SIMATIC NET Version 8.2 SP1 and higher

PROFIBUS

System interfaces for SIMATIC HMI

System interfaces with WinCC

SIMATIC WinCC

Integration (continued)

PROFIBUS	SIMATIC S5 PROFIBUS FDL	SIMATIC S7 Protocol Suite	PROFIBUS DP	PROFIBUS FMS	Article No.
S7-5613 communication software for S7 functions + FDL • Version 8.1 ¹⁾ for Windows 7 (32/64-bit) and Server 2008 R2 (64-bit) • Edition 2008 SP2 (V7.1) ¹⁾ for Windows XP/2003 Server / (32-bit) 2008 Server	•	•			6GK1713-5CB81-3AA0 6GK1713-5CB71-3AA0
DP-5613 communication software for DP master + FDL • Version 8.1 ¹⁾ for Windows 7 (32/64-bit) and Server 2008 R2 (64-bit) • Edition 2008 SP2 (V7.1) ¹⁾ for Windows XP/2003 Server / (32-bit) 2008 Server	•		•		6GK1713-5DB81-3AA0 6GK1713-5DB71-3AA0
FMS-5613 communication software for PROFIBUS-FMS + FDL • Edition 2008 SP2 (V7.1) ¹⁾ for Windows XP/2003 Server / (32-bit) 2008 Server	•			•	6GK1713-5FB71-3AA0

• System interface possible

¹⁾ See ordering data for SIMATIC NET upgrade package

²⁾ SIMATIC NET Version 8.2 SP1 and higher

Integration (continued)
Communication examples

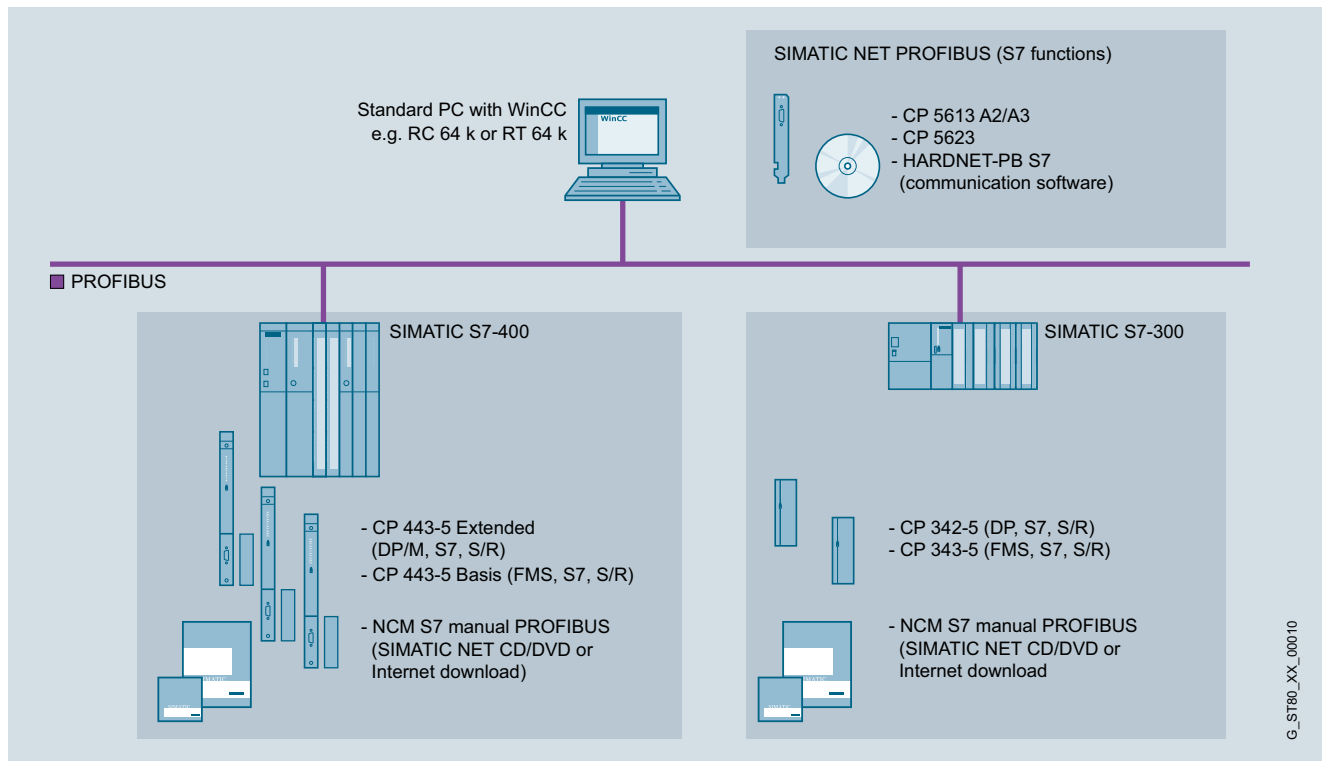

WinCC single-user system: PROFIBUS with S7 communication

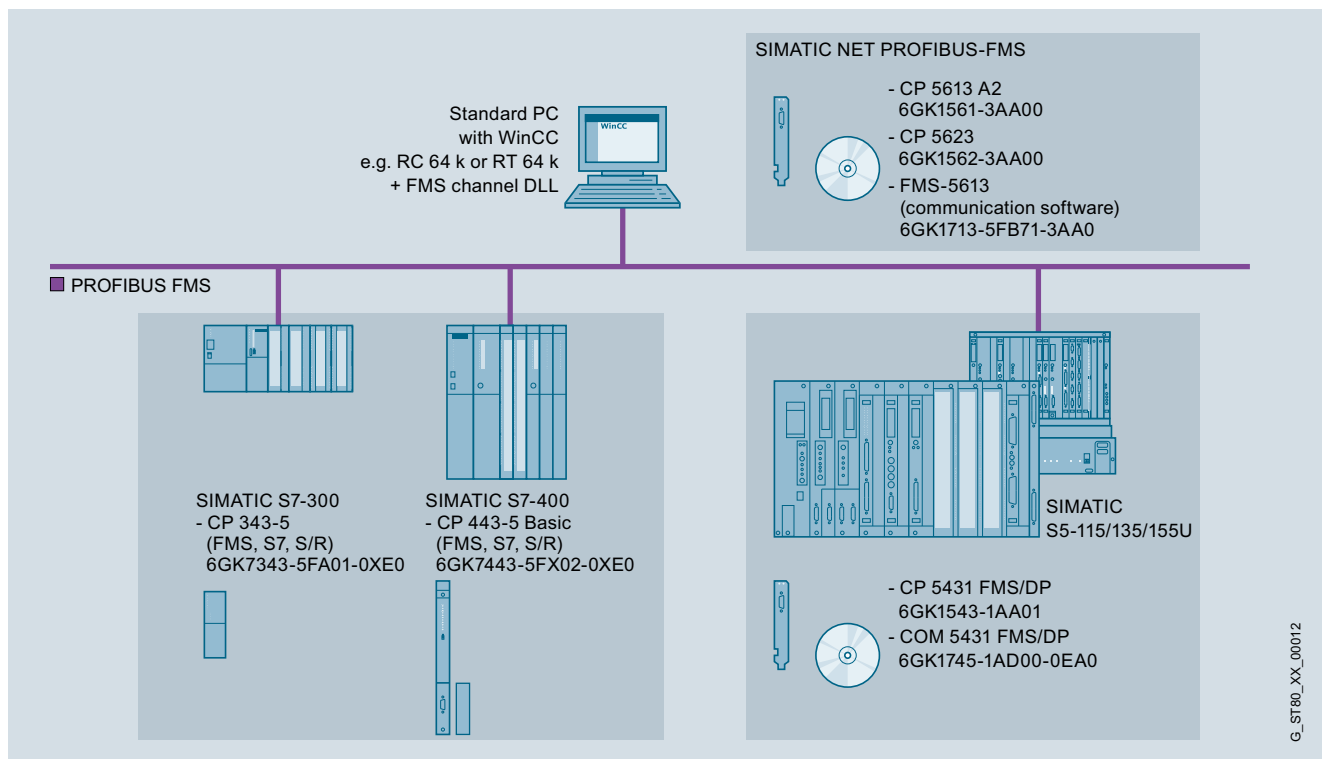

WinCC single-user system: PROFIBUS FMS

PROFIBUS

System interfaces for SIMATIC HMI System interfaces with WinCC

SIMATIC WinCC

Integration (continued)

3

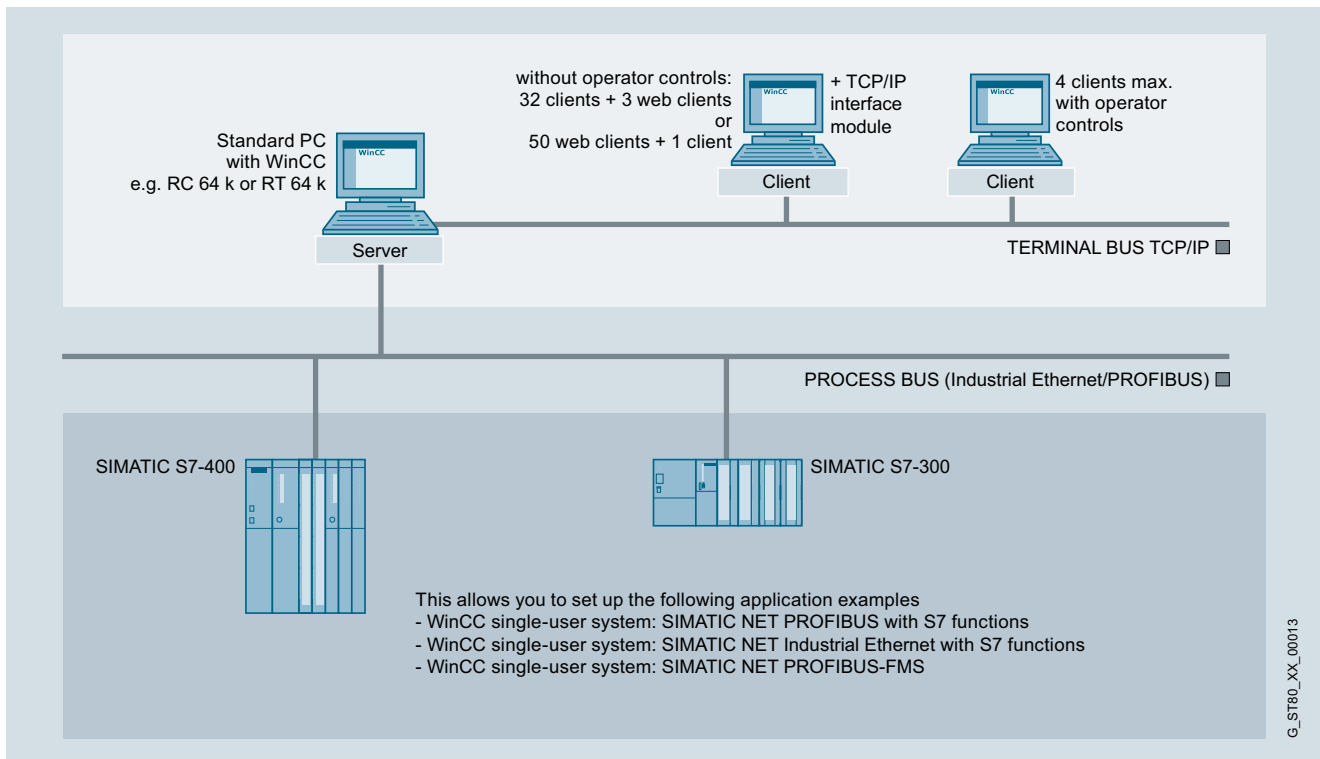

WinCC multi-user system with operable server

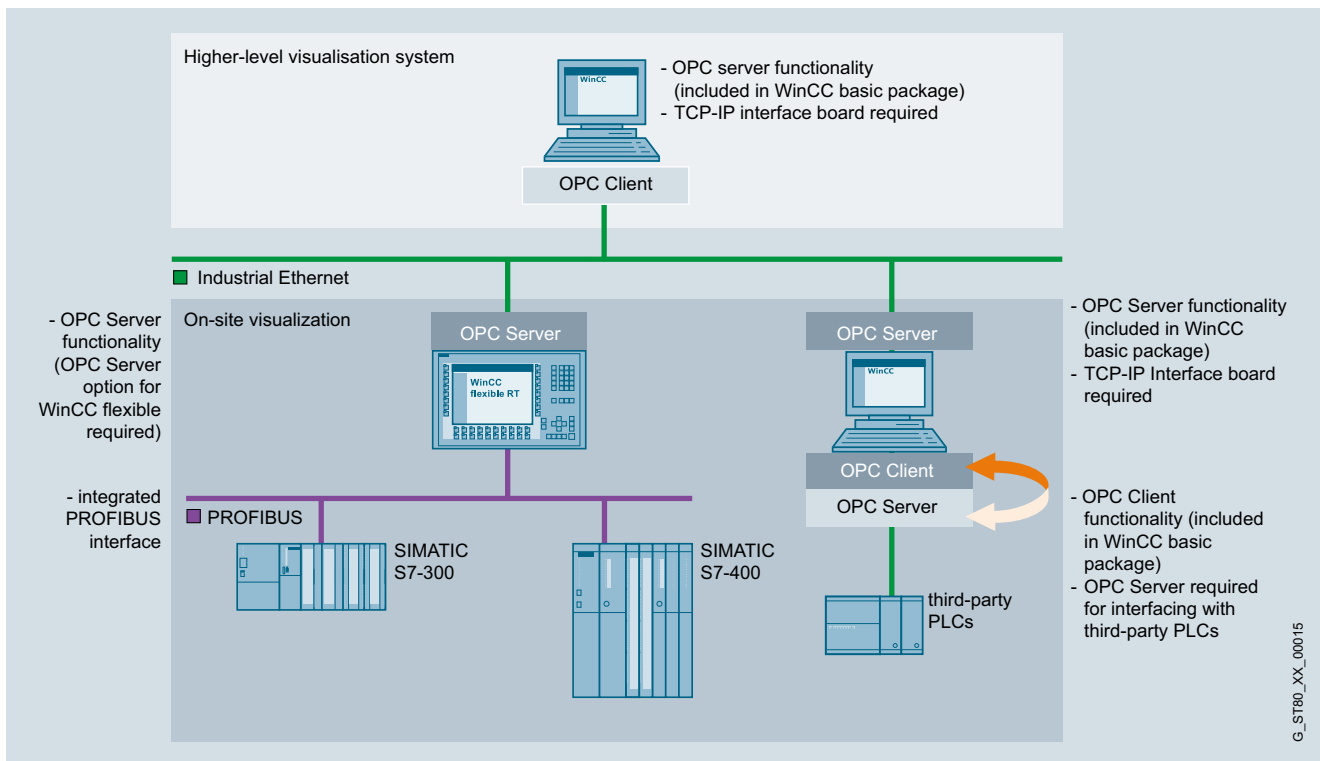

OPC link

Technical specifications

Type	SIMATIC WinCC V7.2 and V7.0 SP3	SIMATIC WinCC V6.2 SP3
Operating system	<ul style="list-style-type: none"> Windows 7 (32 bit / 64 bit) Ultimate, Professional and Enterprise Windows XP Professional SP3 Windows 2003 Server SP2 and Windows 2003 Server R2 SP2 Windows Server 2008 SP2 (32 bit) Standard Windows Server 2008 R2 SP1 (64 bit) Standard 	<ul style="list-style-type: none"> Windows XP Professional SP3, Windows 2000 Professional SP4, Windows Server 2003 SP2, Windows Server 2003 R2 SP2
PC hardware requirements		
Processor type ¹⁾		
• Minimum	Single-user station/server: Pentium 4, 2.5 GHz ²⁾ Central Archive Server (V7.0 SP3): Pentium 4, 2.5 GHz Client: Pentium 3, 1 GHz ²⁾ WebClient/DataMonitor Client: Pentium III, 600 MHz ²⁾	Single-user station/server: Pentium III, 1 GHz Central Archive Server: Pentium 4, 2 GHz Client: Pentium III, 600 MHz
• Recommended	Single-user station/server: Pentium 4 or Dual Core, 3 GHz ²⁾ Central Archive Server (V7.0 SP3): Pentium 4 or Dual Core, 3 GHz Client: Pentium 4, 2 GHz ²⁾ WebClient/DataMonitor Client: Pentium III, 1 GHz	Single-user station/server: Pentium 4, 2 GHz Central Archive Server: Pentium 4, 2.5 GHz Client: Pentium III, 1 GHz WebClient/DataMonitor Client: Pentium III, 1 GHz
RAM		
• Minimum	Single-user station/server: 4 GB ²⁾ Central Archive Server: 4 GB Client: 1 GB ²⁾ WebClient/DataMonitor Client: 512 MB ²⁾	Single-user station: 512 MB, server: 1 GB Central Archive Server: 1 GB Client: 512 MB WebClient/DataMonitor Client: 256 MB
• Recommended	Single-user station/server: 8 GB ²⁾ Central Archive Server: ≥ 4 GB Client: 2 GB ²⁾ WebClient/DataMonitor Client: 1 GB ²⁾	Single-user station: ≥ 1 GB, server: >1 GB Central Archive Server: ≥ 2 GB Client: 512 MB WebClient/DataMonitor Client: 512 MB
Graphics card		
• Minimum	16 MB, 800 x 600 ²⁾	16 MB, 800 x 600
• Recommended	32 MB, 1 280 x 1 024 ²⁾	32 MB, 1 280 x 1 024
Hard disk		
• Minimum	Single-user station/server: 80 GB Client: 20 GB Central Archive Server: 40 GB WebClient/DataMonitor Client: 5 GB	Single-user station/server: 20 GB Client: 5 GB Central Archive Server: 40 GB WebClient/DataMonitor Client: 5 GB
• Recommended	Single-user station/server: 160 GB Client: 40 GB Central Archive Server: 2 x 80 GB WebClient/DataMonitor Client: 10 GB	Single-user station/server: 80 GB Client: 20 GB Central Archive Server: 2 x 80 GB WebClient/DataMonitor Client: 10 GB
• Hard disk (available memory for installation)		
- Minimum	Server: >1.5 GB Client: 1.5 GB	Server: 1.5 GB Client: 1 GB
- Recommended	Server: >10 GB Client: >1.5 GB	Server: >10 GB Client: >1.5 GB
CD-ROM/DVD-ROM/disk drive/USB port	for software installation	for software installation

¹⁾ An AMD system with comparable performance can also be used

²⁾ Hardware requirements when using Microsoft XP Professional

PROFIBUS

System interfaces for SIMATIC HMI

System interfaces with WinCC

SIMATIC WinCC

Technical specifications (continued)

Type	SIMATIC WinCC
Functionality/quantity structure	
Number of messages	150 000
• Message text (number of characters)	10 x 256
• Message archive	> 500 000 messages ¹⁾
• Process values per message	10
• Constant load of messages, max.	Central Archive Server: 100/sec Server/single-user station: 10/s
• Message burst, max.	Server/single-user station: 2 000/10 s every 5 min
Archives	
• Archive data points	Max. 120 000 per server ²⁾
• Archive types	Short-term archive with and without long-term archiving
• Data storage format	Microsoft SQL Server 2005
• Measured values per second, max.	Server/single-user station: 5 000/s
User archive	
• Archives and views	500 each
• Product consisting of data record and column per user archive	320 000
• Fields per user archive	500
Graphics system	
• Number of screens	System-limited ¹⁾
• Number of objects per screen	System-limited ¹⁾
• Number of controllable fields per screen	System-limited ¹⁾
PowerTags	256 K ³⁾
Trends	
• Trend views per image	25
• Trends per trend view	80
User administration	
• User groups	128
• Number of users	128
• Authorization groups	999
Configuration languages	
	5 European (Eng., Fr., Ger., It., Sp.) 4 Asian (simpl.+trad. Chi/Kor/Jpn) ⁴⁾
Protocols	
• Message sequence reports (simultaneously)	1 per server/single-user station
• Message archive reports (simultaneously)	3
• User reports	System-limited ¹⁾
• Report lines per group	66
• Variables per report	300 ⁵⁾
Multi-user system	
• Server	18
• Clients for server with operator station	4
• Clients for server without operator station	32 clients + 3 WebClients or 50 WebClients + 1 client

¹⁾ Dependent on the available storage space

²⁾ Dependent on the number of licensed archive variables

³⁾ Dependent on number of licensed PowerTags

⁴⁾ Asian versions for Version 7 SP1 or higher

⁵⁾ The number of variables per report is dependent on process communication performance

Ordering data

Article No.

SIMATIC WinCC system software V7.2

Runtime packages on DVD

Language/script versions:
DE/EN/FR/IT/ES;
with license for

- WinCC RT Client
- 128 PowerTags (RT 128)
- 512 PowerTags (RT 512)
- 2 048 PowerTags (RT 2048)
- 8 192 PowerTags (RT 8192)
- 65 536 PowerTags (RT 65536)
- 102 400 PowerTags (RT 102400)
- 153 600 PowerTags (RT 153600)
- 262 144 PowerTags (RT 262144)

6AV6381-2CA07-2AX0
6AV6381-2BC07-2AX0
6AV6381-2BD07-2AX0
6AV6381-2BE07-2AX0
6AV6381-2BH07-2AX0
6AV6381-2BF07-2AX0
6AV6381-2BJ07-2AX0
6AV6381-2BK07-2AX0
6AV6381-2BL07-2AX0

Including 512 archive tags each

Complete packages on DVD

Language versions:
DE/EN/FR/IT/ES;
with license for

- WinCC RC Client
- 128 PowerTags (RC 128)
- 512 PowerTags (RC 512)
- 2 048 PowerTags (RC 2048)
- 8 192 PowerTags (RC 8192)
- 65 536 PowerTags (RC 65536)
- 102 400 PowerTags (RC 102400)
- 153 600 PowerTags (RC 153600)
- 262 144 PowerTags (RC 262144)

6AV6381-2CB07-2AX0
6AV6381-2BM07-2AX0
6AV6381-2BN07-2AX0
6AV6381-2BP07-2AX0
6AV6381-2BS07-2AX0
6AV6381-2BQ07-2AX0
6AV6381-2BT07-2AX0
6AV6381-2BU07-2AX0
6AV6381-2BV07-2AX0

SIMATIC WinCC system software V7.2 ASIA

Runtime packages on DVD

Language/script versions:
EN, CHS, CHT, KOR, JPN;
with license for

- WinCC RT Client
- 128 PowerTags (RT 128)
- 512 PowerTags (RT 512)
- 2 048 PowerTags (RT 2048)
- 8 192 PowerTags (RT 8192)
- 65 536 PowerTags (RT 65536)
- 102 400 PowerTags (RT 102400)
- 153 600 PowerTags (RT 153600)
- 262 144 PowerTags (RT 262144)

6AV6381-2CA07-2AV0
6AV6381-2BC07-2AV0
6AV6381-2BD07-2AV0
6AV6381-2BE07-2AV0
6AV6381-2BH07-2AV0
6AV6381-2BF07-2AV0
6AV6381-2BJ07-2AV0
6AV6381-2BK07-2AV0
6AV6381-2BL07-2AV0

Including 512 archive tags each

Complete packages on DVD

Language versions:
EN, CHS, CHT, KOR, JPN;
with license for

- WinCC RC Client
- 128 PowerTags (RC 128)
- 512 PowerTags (RC 512)
- 2 048 PowerTags (RC 2048)
- 8 192 PowerTags (RC 8192)
- 65 536 PowerTags (RC 65536)
- 102 400 PowerTags (RC 102400)
- 153 600 PowerTags (RC 153600)
- 262 144 PowerTags (RC 262144)

6AV6381-2CB07-2AV0
6AV6381-2BM07-2AV0
6AV6381-2BN07-2AV0
6AV6381-2BP07-2AV0
6AV6381-2BS07-2AV0
6AV6381-2BQ07-2AV0
6AV6381-2BT07-2AV0
6AV6381-2BU07-2AV0
6AV6381-2BV07-2AV0

Ordering data**Article No.****Article No.****SIMATIC WinCC V7.2 Powerpacks**

For upgrading from:

Runtime packages

- 128 to 512 PowerTags
- 512 to 2 048 PowerTags
- 2 048 to 8 192 PowerTags
- 8 192 to 65 536 PowerTags
- 65 536 to 102 400 PowerTags
- 102 400 to 153 600 PowerTags
- 153 600 to 262 144 PowerTags

6AV6371-2BD07-2AX0
6AV6371-2BG07-2AX0
6AV6371-2BM07-2AX0
6AV6371-2BN07-2AX0
6AV6371-2BP07-2AX0
6AV6371-2BQ07-2AX0
6AV6371-2BR07-2AX0

Complete packages

- 128 to 512 PowerTags
- 512 to 2 048 PowerTags
- 2 048 to 8 192 PowerTags
- 8 192 to 65 536 PowerTags
- 65 536 to 10 2400 PowerTags
- 102 400 to 153 600 PowerTags
- 153 600 to 262 144 PowerTags

6AV6371-2BD17-2AX0
6AV6371-2BG17-2AX0
6AV6371-2BM17-2AX0
6AV6371-2BN17-2AX0
6AV6371-2BP17-2AX0
6AV6371-2BQ17-2AX0
6AV6371-2BR17-2AX0

SIMATIC WinCC V7.2 archives

- 1 500 archives
- 5 000 archives
- 10 000 archives
- 30 000 archives
- 80 000 archives

6AV6371-1DQ17-2AX0
6AV6371-1DQ17-2BX0
6AV6371-1DQ17-2CX0
6AV6371-1DQ17-2EX0
6AV6371-1DQ17-2GX0

SIMATIC WinCC V7.2 Archive Powerpacks

For upgrading archiving from

- 1 500 to 5 000 archive tags
- 5 000 to 10 000 archive tags
- 10 000 to 30 000 archive tags
- 30 000 to 80 000 archive tags

6AV6371-1DQ17-2AB0
6AV6371-1DQ17-2BC0
6AV6371-1DQ17-2CE0
6AV6371-1DQ17-2EG0

SIMATIC WinCC Upgrade/Software Update Service**SIMATIC WinCC V7.2 upgrade ¹⁾**

For upgrading the RT version

- from V6.2 to V7.2
- from V7.0 to V7.2
- from V6.2 ASIA to V7.2 ASIA
- from V7.0 ASIA to V7.2 ASIA

6AV6381-2AA07-2AX4
6AV6381-2AA07-2AX3
6AV6381-2AA07-2AV4
6AV6381-2AA07-2AV3

For upgrading the Client RT version

- from V6.2 to V7.2
- from V7.0 to V7.2
- from V6.2 ASIA to V7.2 ASIA
- from V7.0 ASIA to V7.2 ASIA

6AV6381-2BC07-2AX4
6AV6381-2BC07-2AX3
6AV6381-2BC07-2AV4
6AV6381-2BC07-2AV3

For upgrading the RC version

- from V6.2 to V7.2
- from V7.0 to V7.2
- from V6.2 ASIA to V7.2 ASIA
- from V7.0 ASIA to V7.2 ASIA

6AV6381-2AB07-2AX4
6AV6381-2AB07-2AX3
6AV6381-2AB07-2AV4
6AV6381-2AB07-2AV3

SIMATIC WinCC Software Update Service (SUS) ^{2) 3)}**SIMATIC WinCC V7 Update**

Software Update Service for WinCC basic software and options:

- 1 license
- 3 licenses
- 10 licenses

6AV6381-1AA00-0AX5
6AV6381-1AA00-0BX5
6AV6381-1AA00-0CX5

¹⁾ According to licensing provisions, 1 upgrade package must be ordered for each WinCC station

²⁾ The Software Update Service is valid for 1 year. The contract is automatically extended by 1 more year unless canceled 3 months prior to expiration. According to licensing provisions, 1 Software Update Service must be ordered for each WinCC station.

³⁾ Requires the current software version

SIMATIC WinCC system software V6.2 SP3**Runtime packages on CD-ROM**Language/script versions:
DE/EN/FR/IT/ES;
with license for

- 128 PowerTags (RT 128)
- 256 PowerTags (RT 256)
- 1 024 PowerTags (RT 1024)
- 8 192 PowerTags (RT 8192)
- 65 536 PowerTags (RT 65536)
- 102 400 PowerTags (RT 102400)
- 153 600 PowerTags (RT 153600)
- 262 144 PowerTags (RT 262144)

6AV6381-1BC06-2AX0
6AV6381-1BD06-2AX0
6AV6381-1BE06-2AX0
6AV6381-1BH06-2AX0
6AV6381-1BF06-2AX0
6AV6381-1BJ06-2AX0
6AV6381-1BK06-2AX0
6AV6381-1BL06-2AX0

Including 512 archive tags each

Complete packages on CD-ROMLanguage versions:
DE/EN/FR/IT/ES;
with license for

- 128 PowerTags (RC 128)
- 256 PowerTags (RC 256)
- 1 024 PowerTags (RC 1024)
- 8 192 PowerTags (RC 8192)
- 65 536 PowerTags (RC 65536)
- 102 400 PowerTags (RC 102400)
- 153 600 PowerTags (RC 153600)
- 262 144 PowerTags (RC 262144)

6AV6381-1BM06-2AX0
6AV6381-1BN06-2AX0
6AV6381-1BP06-2AX0
6AV6381-1BS06-2AX0
6AV6381-1BQ06-2AX0
6AV6381-1BT06-2AX0
6AV6381-1BU06-2AX0
6AV6381-1BV06-2AX0

Including 512 archive tags each

SIMATIC WinCC system software V6.2 SP3 ASIA**Runtime packages on CD-ROM**Language versions:
English/simplified and traditional
Chinese/Korean/Taiwanese/
Japanese;
with license for

- 128 PowerTags (RT 128)
- 256 PowerTags (RT 256)
- 1 024 PowerTags (RT 1024)
- 8 192 PowerTags (RT 8192)
- 65 536 PowerTags (RT 65536)

6AV6381-1BC06-2AV0
6AV6381-1BD06-2AV0
6AV6381-1BE06-2AV0
6AV6381-1BH06-2AV0
6AV6381-1BF06-2AV0

Including 512 archive tags each

Complete packages on CD-ROMLanguage versions:
English/simplified and traditional
Chinese/Korean/Taiwanese,
Japanese;
with license for

- 128 PowerTags (RC 128)
- 256 PowerTags (RC 256)
- 1 024 PowerTags (RC 1024)
- 8 192 PowerTags (RC 8192)
- 65 536 PowerTags (RC 65536)

6AV6381-1BM06-2AV0
6AV6381-1BN06-2AV0
6AV6381-1BP06-2AV0
6AV6381-1BS06-2AV0
6AV6381-1BQ06-2AV0

Including 512 archive tags each

PROFIBUSSystem interfaces for SIMATIC HMI
System interfaces with WinCC

SIMATIC WinCC

Ordering data**Article No.****Article No.***SIMATIC WinCC V6.2 PowerPacks*

For upgrading from:

Runtime packages

- 128 to 256 PowerTags
- 128 to 1 024 PowerTags
- 128 to 8 192 PowerTags
- 128 to 65 536 PowerTags
- 256 to 1 024 PowerTags
- 256 to 8 192 PowerTags
- 256 to 65 536 PowerTags
- 1 024 to 8 192 PowerTags
- 1 024 to 65 536 PowerTags
- 8 192 to 65 536 PowerTags

6AV6371-1BD06-2AX0
6AV6371-1BE06-2AX0
6AV6371-1BK06-2AX0
6AV6371-1BF06-2AX0
6AV6371-1BG06-2AX0
6AV6371-1BL06-2AX0
6AV6371-1BH06-2AX0
6AV6371-1BM06-2AX0
6AV6371-1BJ06-2AX0
6AV6371-1BN06-2AX0

Complete packages

- 128 to 256 PowerTags
- 128 to 1 024 PowerTags
- 128 to 8 192 PowerTags
- 128 to 65 536 PowerTags
- 256 to 1 024 PowerTags
- 256 to 8 192 PowerTags
- 256 to 65 536 PowerTags
- 1 024 to 8 192 PowerTags
- 1 024 to 65 536 PowerTags
- 8 192 to 65 536 PowerTags

6AV6371-1BD16-2AX0
6AV6371-1BE16-2AX0
6AV6371-1BK16-2AX0
6AV6371-1BF16-2AX0
6AV6371-1BG16-2AX0
6AV6371-1BL16-2AX0
6AV6371-1BH16-2AX0
6AV6371-1BM16-2AX0
6AV6371-1BJ16-2AX0
6AV6371-1BN16-2AX0

SIMATIC WinCC V6.2 Archive

- 1 500 archives
- 5 000 archives
- 10 000 archives
- 30 000 archives
- 80 000 archives
- 120 000 archives

6AV6371-1DQ16-2AX0
6AV6371-1DQ16-2BX0
6AV6371-1DQ16-2CX0
6AV6371-1DQ16-2EX0
6AV6371-1DQ16-2GX0
6AV6371-1DQ16-2JX0

SIMATIC WinCC V6.2 Archive Powerpacks

For upgrading archiving from

- 1 500 to 5 000 archive tags
- 5 000 to 10 000 archive tags
- 10 000 to 30 000 archive tags
- 30 000 to 80 000 archive tags
- 80 000 to 120 000 archive tags

6AV6371-1DQ16-2AB0
6AV6371-1DQ16-2BC0
6AV6371-1DQ16-2CE0
6AV6371-1DQ16-2EG0
6AV6371-1DQ16-2GJ0

SIMATIC WinCC V6.2 upgrade ¹⁾

For upgrading the RT version

- from V5.x to V6.2 SP3
- from V6.x to V6.2 SP3
- from V5.x ASIA to V6.2 SP3 ASIA
- from V6.x ASIA to V6.2 SP3 ASIA

6AV6381-1AA06-2AX4
6AV6381-1AA06-2AX3
6AV6381-1AA06-2AV4
6AV6381-1AA06-2AV3

For upgrading the RC version

- from V5.x to V6.2 SP3
- from V6.x to V6.2 SP3
- from V5.x ASIA to V6.2 SP3 ASIA
- from V6.x ASIA to V6.2 SP3 ASIA

6AV6381-1AB06-2AX4
6AV6381-1AB06-2AX3
6AV6381-1AB06-2AV4
6AV6381-1AB06-2AV3

¹⁾ According to licensing provisions, 1 upgrade package must be ordered for each WinCC station.

More information**WinCC language versions**

SIMATIC WinCC is also offered in simplified Chinese, traditional Chinese, Korean and Japanese especially for Asian markets. These WinCC versions are intended for machine manufacturers, plant constructors and exporters who supply the regions of China, Taiwan, Korea and Japan.

WinCC ASIA includes all familiar WinCC functions and offers in addition the configuration user interface in the respective national language and English. The online help is available in simplified Chinese, traditional Chinese, Korean, Japanese and English. A Chinese, Korean, Japanese or multilingual Windows operating system is required for operation.

WinCC ASIA is delivered on a separate DVD which contains all of the above mentioned language versions. The corresponding documentation can be obtained from the national subsidiaries in China, Korea, Taiwan and Japan.

The runtime licenses are language-neutral. The English handling program (Automation License Manager – ALM) is executable under the Chinese, Korean and Japanese Windows versions.

In order to use the Asian languages in WinCC, an Asia hardware dongle is required.

Additional information is available on the Internet at:

<http://www.siemens.com/wincc>

Separate configurators are available for PC hardware:

- SIMATIC IPC547C
- SIMATIC IPC647C
- SIMATIC IPC847C
- SIMATIC IPC427C, SIMATIC IPC427D
- SIMATIC IPC627C
- SIMATIC Box PC 827C
- SIMATIC IPC477C, SIMATIC IPC477D
- SIMATIC HMI IPC577C
- SIMATIC HMI IPC677C

Overview



- Interconnecting two PROFIBUS DP networks
- The interchange of data between both DP networks takes place by internal copying in the coupler.

Application

The PROFIBUS DP/DP coupler interconnects two PROFIBUS DP networks. Byte data (0 ... 244 byte) is transferred from the DP master of the first network to the DP master of another network and vice versa.

The principle corresponds to the hardware wiring of inputs and outputs used today. The coupler has two independent DP interfaces with which the two DP networks are connected.

The DP/DP coupler is a slave on each DP network. The interchange of data between both DP networks takes place by internal copying in the coupler.

Design

The DP/DP transceiver is housed in a 40 mm casing of the S7-300 series. It can be mounted on a standard mounting rail (7.5 mm and 15 mm) as well as on a mounting rail for the S7 design.

The preferred arrangement is upright in a row, side by side, and without clearance.

The transceiver is connected to the PROFIBUS DP networks through an integral 9-pin sub-D connector.

Function

The DP/DP coupler continuously copies the output data from one network to the input data of the other network (and vice versa).

Functions

- Data exchange of up to 244 byte of input and output data of which up to 128 >byte can be consistent
- Up to 16 input/output ranges for exchanging data
- If one side fails, the outputs on the other side maintain the previous value
- Support of DPV1 with full diagnostics
- Adjustment of DP/DP coupler either via switch or STEP 7
- Different baud rate settings are possible
- Electrical isolation between the two DP networks
- Power is supplied to both sides

Parameter assignment

The PROFIBUS DP addresses are set via two DIP switches on the top of the coupler.

The coupler is configured either with STEP 7 or with a configuring tool which integrates the DP/DP coupler with the help of a GSD file.

The data length is adjusted with the corresponding configuring tool.

Technical specifications

DP/DP transceiver	
PROFIBUS transmission rate	max. 12 Mbit/s
Interfaces	
• PROFIBUS DP	9-pin Sub-D connector
Supply voltage	24 V DC
Current consumption typ.	150 mA
Mounting	Upright (DIP switches above)
Perm. environmental conditions	
• Operating temperature	
- horizontal mounting	0°C ... +60°C
- all other mounting positions	0°C ... +40°C
• Transport/storage temperature	-40 °C ... +70 °C
• Relative humidity	10 ... 95 % at +25 °C
Design	
• Dimensions (W x H x D) in mm	40 x 127 x 117
• Weight	approx. 250 g
Degree of protection	IP20

Ordering data

Article No.

DP/DP coupler

6ES7158-0AD01-0XA0

Note:

The manual is available free on the Internet.

More information

Brochures

Information material for downloading can be found in the Internet:

<http://www.siemens.com/simatic/printmaterial>

PROFIBUS

Network transitions

PA routers

Overview



To create a smooth network transition between PROFIBUS DP and PROFIBUS PA, the SIMATIC product range offers two versions: the DP/PA coupler and the PA link.

The following criteria can be applied when choosing the network transition:

- DP/PA coupler:
For small quantity frameworks (volumes of data) and low timing requirements; limiting of data transfer rate on the PROFIBUS DP to 45.45 kbit/s
- PA link:
For large number of stations and high cycle time requirements; data transfer rate on the PROFIBUS DP up to 12 Mbit/s

Application

The two PA routers are based on two versions of the DP/PA coupler:

- Ex [i] DP/PA coupler (max. output current 110 mA) for implementation of PROFIBUS PA networks with a line or tree topology in environments up to Ex zone 1/21, not for redundant architectures (coupler redundancy, ring)
- FDC 157-0 DP/PA coupler (max. output current 1 000 mA) for implementation of PROFIBUS PA networks with a line, tree or ring topology in environments up to Ex zone 2/22; can be used for the redundant architectures "Ring" and "Coupler redundancy"

DP/PA couplers are also integral components of the PA link (see design). The PA link connects PROFIBUS DP and PROFIBUS PA together, and decouples the transmission rates. In contrast to the DP/PA coupler which limits the data transmission rate on the PROFIBUS DP to 45.45 kbit/s, the PA link does not influence the performance of the PROFIBUS DP.

The PA link functions as a slave on the PROFIBUS DP and as a master on the PROFIBUS PA. From the viewpoint of the host PROFIBUS DP master, the PA link is a modular slave whose modules are the devices connected on the PROFIBUS PA. Addressing of these devices is carried out indirectly via the PA link that itself only requires one node address. The host PROFIBUS master can scan devices connected to the PA link all at once.

If the router is a DP/PA coupler, the nodes on the PROFIBUS PA are directly addressed by the PROFIBUS DP master (controller). The DP/PA coupler is an electrical node, but is transparent for communication between the master and PA field devices; it therefore does not require setting of parameters or addresses (exception: FDC 157-0 DP/PA coupler used as PROFIBUS diagnostics slave).

PROFIBUS diagnostics with FDC 157-0 DP/PA coupler, configured as PROFIBUS diagnostics slave

FDC 157-0 DP/PA couplers configured as PROFIBUS diagnostics slaves supply extensive diagnostic and status information via PROFIBUS for swift localization and correction of faults:

- I&M (Identification & Maintenance) data
- Current and voltage values on the main cable
- Redundancy status
- Wire breakage
- Short-circuit
- Signal level

To this end, each of these DP/PA couplers FDC 157-0 requires its own PROFIBUS address. This applies independent of use in a PA Link or as a PA router.

The PA link and DP/PA coupler approved for an extended temperature range are available for use in environments up to Ex zone 2/22. Both are operated with 24 V DC. Assembly is on an S7-300 rail with horizontal or vertical alignment.

Design

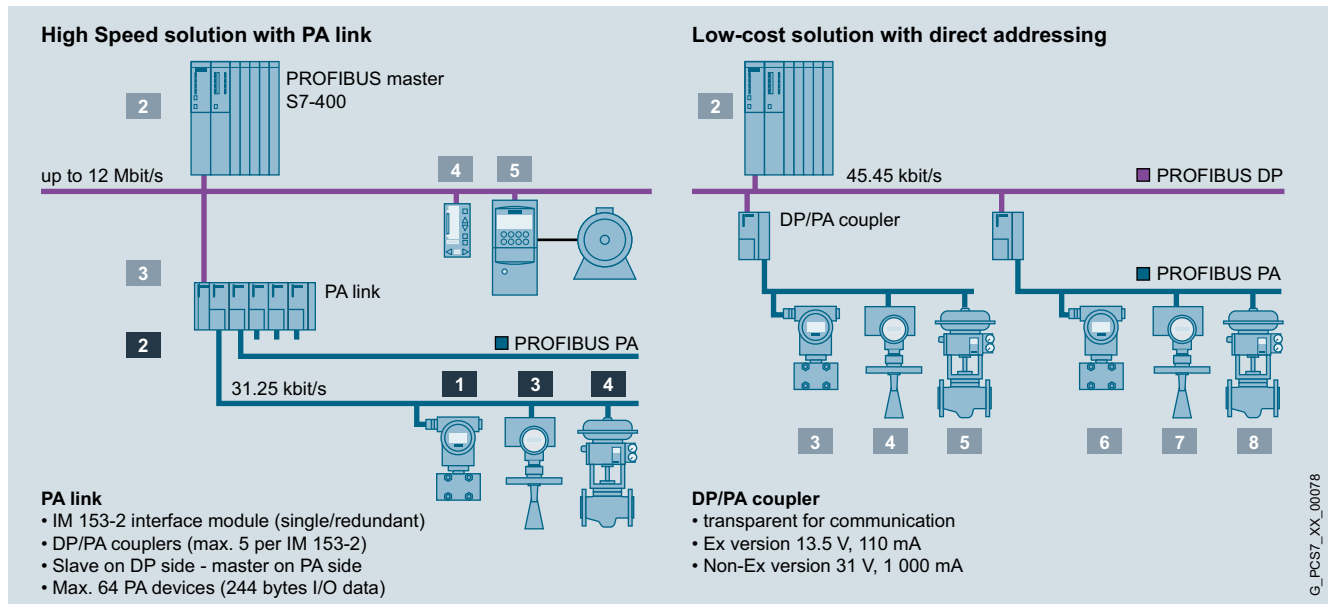

Configuration examples for PA link and DP/PA coupler

PA link

The PA link is a modular combination in S7-300 design consisting of the IM 153-2 High Feature PROFIBUS DP interface module (with optional redundancy) and up to 5 DP/PA couplers (FDC 157-0 or Ex [i]).

All components of the PA link are interconnected through the S7 backplane bus. The use of active bus modules as backplane bus allows hot swapping of individual modules and redundancy of the IM 153-2 High Feature PROFIBUS DP interface modules and the FDC 157-0 DP/PA coupler. If redundancy and changes during operation are not required, passive bus connectors can be used instead of active bus modules.

The PS 307 or PS 305 load power supply can be used for the 24 V DC. With a redundant IM 153-2 High Feature interface module for PROFIBUS DP, it is also recommendable to have a redundant 24 V DC supply, e.g. with two PS 307/PS 305 load power supplies.

The PROFIBUS PA bus segments designed with the DP/PA couplers are physically separated as regards current infeed, but form one bus system in communication terms. A PROFIBUS PA ring segment or a PROFIBUS PA line segment with coupler redundancy can be operated on a PA link. Further PROFIBUS PA line segments can be operated on this PA link using individual couplers. The FDC 157-0 DP/PA couplers provided for the ring coupling or coupler redundancy must always be located at the right-hand end of a sequence of up to 5 couplers.

The following basic components are available for configuring the PA link:

- IM 153-2 High Feature interface module for extended temperature range
- DP/PA coupler (Ex [i] and FDC 157-0)
- Components for redundant design and for hot swapping
 - Mounting rail for hot swapping (as an alternative to the standard mounting rail)
 - BM PS/IM for 1 load power supply and 1 IM 153-2 High Feature module, for extended temperature range
 - IM/IM (IM 157) bus module for two IM 153-2 High Feature modules, for redundant and non-redundant design and for extended temperature range
 - BM FDC for 1 DP/PA coupler Ex [i] or FDC 157-0, for extended temperature range (up to 5 DP/PA couplers possible per PA link)
 - BM FDC/FDC for 2 DP/PA couplers FDC 157-0, for extended temperature range

Additive option:

- PS 307 for 120/230 V AC; 24 V DC load power supply, version in 2, 5 or 10 A, or
- PS 305 load power supply for 24/48/60/110 V DC; 24 V DC, 2 A

PROFIBUS

Network transistions

PA routers

Technical specifications

DP/PA coupler

Bus connection

Connection for PROFIBUS PA

- DP/PA coupler Ex [i]

2 terminals of a 4-pole screw-type terminal, integrated terminating resistor

- DP/PA coupler FDC 157-0

4-pole screw-type terminal for connection and looping through, selectable terminating resistor

Connection for PROFIBUS DP

9-pin Sub-D plug, contact assignment as described in IEC 61158/EN 50170

Module-specific data

Degree of protection	IP20
Transmission rate on PROFIBUS DP	45.45 Kbps
Transmission rate on PROFIBUS PA	31.25 Kbps
Communication protocol	PROFIBUS DP

Voltages, currents, potentials

Supply voltage	24 V DC (20.4 V ... 28.8 V)
Reverse polarity protection	Yes
Overvoltage protection	Yes
Voltage at coupler output (PA)	
• DP/PA coupler Ex [i]	13 V ... 14 V DC
• DP/PA coupler FDC 157-0	31 ± 1 V DC
Voltage monitoring	15.5 V
Overvoltage monitoring	U > 35 V; latching cutoff
Voltage failure bridging	Min. 5 ms
Current at coupler output (PA) for supplying the PA field devices	
• DP/PA coupler Ex [i]	Max. 110 mA
• DP/PA coupler FDC 157-0	Max. 1 A
Galvanic isolation 24 V DC	
• PROFIBUS DP/PROFIBUS PA	Yes
• PROFIBUS DP/supply	Yes
• PROFIBUS PA/supply	Yes
• All electric circuits/functional grounding	Yes
Power consumption of modules (24 V DC)	
• DP/PA coupler Ex [i]	Max. 400 mA
• DP/PA coupler FDC 157-0	Max. 2.3 A
Power loss of the module	
• DP/PA coupler Ex [i]	Typ. 7 W
• DP/PA coupler FDC 157-0	Typ. 13.4 W

Status, interrupts, diagnostics

Diagnostics displays DP/PA coupler Ex [i] and DP/PA coupler FDC 157-0

- PROFIBUS DP bus monitoring
- PROFIBUS PA bus monitoring
- 24 V DC power supply monitoring

Yellow LED "DP"
Yellow LED "PA"
Green "ON" LED

Additive diagnostics displays of the DP/PA coupler FDC 157-0

- Group error
- Bus error
- Monitoring DP/PA coupler (active coupler in redundant configuration)

Red LED "SF"
Red LED "BF"
Yellow LED "ACT"

Climatic conditions

Permissible operating temperature DP/PA coupler Ex [i] and DP/PA coupler FDC 157-0

- Horizontal installation
- Vertical installation

-25 ... +60 °C
-25 ... +40 °C

Dimensions and weight

Dimensions (W x H x D) in mm

80 x 125 x 130

Weight

- DP/PA coupler Ex [i]
- DP/PA coupler FDC 157-0

Approx. 550 g
Approx. 515 g

Technical specifications (continued)
IM 153-2 High Feature (for extended temperature range)

Function	Linking of PROFIBUS DP (9.6 Kbps to 12 Mbps, slave functionality) and PROFIBUS PA (master functionality) with support of the "Configuration in Run" function The DP/PA link function is only implemented by extending the IM 153-2 High Feature with one or more DP/PA couplers. Stand-alone operation of the IM 153-2 High Feature is not possible. 1 Y coupler, up to 5 DP/PA couplers or up to 64 slaves can be connected Isolation from the higher-level DP master system
Bus connection	
• Connection for PROFIBUS DP	9-pin Sub-D plug, contact assignment as described in IEC 61158/EN 50170, Vol. 2
Connectable lower-level components	
Number of couplers	
• DP/PA coupler	Max. 5
• Y coupler	1
Number of PA devices on PROFIBUS PA	Max. 64
Module-specific data	
Degree of protection	IP20
Transmission rate of the higher level DP master system	9.6; 19.2; 45.45; 93.75; 187.5; 500 Kbps; 1.5; 3; 6; 12 Mbps
Communication protocol	PROFIBUS DP
Frame length	
• I/O data	Max. 244 bytes
• Configuration frame	Max. 244 bytes
• Diagnostics frame	Max. 244 bytes
• Parameter assignment frame	Max. 244 bytes

Voltages, currents, potentials	
Supply voltage	24 V DC (20.4 V ... 28.8 V)
Reverse polarity protection	Yes
Voltage failure bridging	20 ms
Galvanic isolation	
• to the higher-level DP master system	Yes
• to the DP/PA coupler or Y coupler	No
Power consumption of modules (24 V DC)	
• In the PA link	Max. 200 mA (at 20.4 V)
• In the Y link	Max. 400 mA (at 20.4 V)
Power loss of the module	
• In the PA link	Max. 2.6 W (at 28.8 V)
• In the Y link	Max. 3.6 W (at 28.8 V)
Infeed, mechanical design	4-pin screw terminal, short-circuiting link between PE and M24; the short-circuiting link must be removed for floating operation (independent of this, the DP interface is always floating)
Status, interrupts, diagnostics	
Diagnostics displays	
• Group error	Red LED "SF"
• Bus error on higher level DP master system	Red LED "BF 1"
• Bus error on underlying bus system	Red LED "BF 2"
• Module is active in redundancy mode	Yellow LED "ACT"
• 24 V DC power supply monitoring	Green "ON" LED
Climatic conditions	
Permissible operating temperature	
• Horizontal installation	-25 ... +60 °C
• Vertical installation	-25 ... +40 °C
Dimensions and weight	
Dimensions (W x H x D) in mm	40 x 125 x 130
Weight	Approx. 360 g

PROFIBUS

Network transistions

PA routers

Ordering data

DP/PA coupler

For transition from RS 485 to MBP

- DP/PA coupler Ex [i]
Fieldbus coupler between PROFIBUS DP and PROFIBUS PA, EEx(ia) version, max. output current 110 mA; degree of protection IP20; for extended temperature range, permissible operating temperature -25 to +60 °C
- DP/PA coupler FDC 157-0
Fieldbus coupler between PROFIBUS DP and PROFIBUS PA, with redundancy capability; integrated PROFIBUS diagnostics slave; max. output current 1 A; degree of protection IP20; for extended temperature range, permissible operating temperature -25 to +60 °C

Article No.

6ES7157-0AD82-0XA0

6ES7157-0AC83-0XA0

Article No.

Components for hot swapping and for redundant design

Active bus modules for hot swapping

- BM PS/IM SIPLUS extreme
for 1 load current supply and 1 IM 153-2 High Feature module; for "hot swapping" function, for extended temperature range, permissible operating temperature -25 to +70 °C
- BM IM/IM
for 2 IM 153-2 High Feature modules, for redundant and non-redundant configuration, for "hot swapping" function, for extended temperature range, permissible operating temperature -25 to +60 °C
- BM FDC
for 1 DP/PA coupler Ex [i] or FDC 157-0, for "hot swapping" function, for extended temperature range, permissible operating temperature -25 to +60 °C
- BM FDC/FDC
for 2 DP/PA couplers FDC 157-0, for "hot swapping" function, for extended temperature range, permissible operating temperature -25 to +60 °C

6AG1195-7HA00-2XA0

6ES7195-7HD80-0XA0

6ES7195-7HF80-0XA0

6ES7195-7HG80-0XA0

IM 153-2 High Feature

Interface module for PA Link and Y-Link; with redundancy capability; degree of protection IP20; for extended temperature range, permissible operating temperature -25 to +60 °C

6ES7153-2BA82-0XB0

Accessories

PS 307 Load Power Supply

Including connecting comb; 120/230 V AC; 24 V DC

- 2 A; 40 mm wide
- 5 A; 60 mm wide
- 5 A, extended temperature range; 80 mm wide
- 10 A, 80 mm wide

6ES7307-1BA01-0AA0

6ES7307-1EA01-0AA0

6ES7307-1EA80-0AA0

6ES7307-1KA02-0AA0

PS 305 Load Power Supply

24/48/60/110 V DC; 24 V DC

- 2 A, extended temperature range; 80 mm wide

6ES7305-1BA80-0AA0

Standard profile rails

(without hot swapping function)

- 482 mm wide (19 inches)
- 530 mm wide

6ES7390-1AE80-0AA0

6ES7390-1AF30-0AA0

Mounting rail for hot swapping

For max. 5 active bus modules

- 482 mm wide (19 inches)
- 530 mm wide
- 620 mm wide

6ES7195-1GA00-0XA0

6ES7195-1GF30-0XA0

6ES7195-1GG30-0XA0

Covers

4 backplane bus covers and 1 cover for active bus module

6ES7195-1JA00-0XA0

Overview

The solid-state SIRIUS 3RW44 soft starters are suitable for the torque-controlled soft starting and ramp-down as well as braking of three-phase asynchronous motors.

Optionally, SIRIUS 3RW44 soft starters can be upgraded with a PROFIBUS DP or PROFINET module. Thanks to their communication capability and their programmable control inputs and relay outputs the SIRIUS 3RW44 soft starters can be very easily and quickly integrated in higher-level controllers.

In addition to soft starting and soft ramp-down, the 3RW44 soft starters provide numerous functions for higher-level requirements. They cover a performance range up to 710 kW (at 400 V) in the inline circuit and up to 1200 kW (at 400 V) in the inside-delta circuit.

The 3RW44 soft starters are characterized by a compact design for space-saving and clearly arranged control cabinet layouts. For optimized motor starting and stopping the innovative SIRIUS 3RW44 soft starters are an attractive alternative with considerable savings potential compared to applications with a frequency converter. The new torque control and adjustable current limiting enable the High-Feature soft starters to be used in nearly every conceivable task. They guarantee the reliable avoidance of sudden torque applications and current peaks during motor starting and stopping. This creates savings potential when calculating the size of the switchgear and when servicing the machinery installed. Be it for inline circuits or inside-delta circuits – the SIRIUS 3RW44 soft starter offers savings especially in terms of size and equipment costs.

The bypass contacts already integrated in the soft starter bypass the thyristors after a motor ramp-up is detected. This results in a further great reduction in the heat loss occurring during operation of the soft starter at rated value.

Combinations of various starting, operating and ramp-down possibilities ensure an optimum adaptation to the application-specific requirements. Operation and commissioning can be performed with the user-friendly keypad and a menu-prompted, multi-line graphic display with background lighting. The optimized motor ramp-up and ramp-down can be effected quickly, easily and reliably by means of just a few settings with a previously selected language. Four-key operation and plain-text displays for each menu option guarantee full clarity at every moment of the parameterization and operation.

Applicable standards

- IEC 60947-4-2
- UL/CSA

Functionality

Equipped with modern, ergonomic user prompting the 3RW44 soft starters can be commissioned quickly and easily using a keypad and a menu-prompted, multi-line graphic display with background lighting. The optimized motor ramp-up and ramp-down can be effected quickly, easily and reliably by means of just a few settings with a selectable language. Four-key operation and plain-text displays for each menu option guarantee full clarity at every moment of the parameterization and operation. During operation and when control voltage is applied, the display field continuously presents measured values and operating values as well as warnings and fault messages. An external display and operator module can be connected by means of a connection cable to the soft starter, thus enabling active indications and the like to be read directly from the control cabinet door.

The SIRIUS 3RW44 soft starters are equipped with optimum functionality. An integral bypass contact system reduces the power loss of the soft starter during operation.

This reliably prevents heating of the switchgear environment. The SIRIUS 3RW44 soft starters have internal device overload protection. This prevents thermal overloading of the power section's thyristors, e.g. due to unacceptably high closing operations.

Wiring outlay for installing an additional motor overload relay is no longer needed as the SIRIUS 3RW44 soft starters perform this function too. In addition they offer adjustable trip classes and a thermistor motor protection function. As an option the thyristors can also be protected by SITOR semiconductor fuses from short-circuiting so that the soft starter is still functional after a short circuit (type of coordination "2"). And even inrush current peaks are reliably avoided thanks to adjustable current limiting.

In addition a creep speed function is available for positioning and setting jobs. With this function the motor can be controlled in both directions of rotation with reduced torque and an adjustable low speed.

On the other hand the SIRIUS 3RW44 soft starters offer a new, combined DC braking function for the fast stopping of driving loads.

Highlights

- Soft starting with breakaway pulse, torque control or voltage ramp, adjustable torque or current limiting as well as any combination of these, depending on load type
- Integrated bypass contact system to minimize power loss
- Various setting options for the starting parameters such as starting torque, starting voltage, ramp-up and ramp-down time, and much more in three separate parameter sets
- Start-up detection
- Inside-delta circuit for savings in terms of size and equipment costs
- Various ramp-down modes selectable: free ramp-down, torque-controlled pump stop, combined DC braking
- Solid-state motor overload and intrinsic device protection
- Thermistor motor protection
- Keypad with a menu-prompted, multi-line graphic display with background lighting
- Interface for communication with the PC for more accurate setting of the parameters as well as for control and monitoring
- Simple integration into the motor feeder
- Simple mounting and commissioning
- Display of operating states and fault messages
- Connection to PROFIBUS and PROFINET with optional PROFIBUS DP or PROFINET module
- External display and operator module
- Mains voltages from 200 to 690 V, 50 to 60 Hz
- Can be used up to 60 °C (derating from 40 °C)

PROFIBUS Soft Starters

3RW44 soft starters for High-Feature applications

Selection and ordering data

Version		Article No.
 <p data-bbox="130 542 279 557">3RW4900-0KC00</p>	<p data-bbox="379 344 699 366">PROFIBUS communication module</p> <p data-bbox="379 372 1085 478">For 3RW44 soft starter integration in the PROFIBUS network with DPV1 slave functionality. With firmware version E04 and higher (or date of manufacture 01.05.2009 and later) of the module, DPV1 operation of the soft starter on a Y-link is also possible (< only DPV0 operation possible with E04).</p>	<p data-bbox="1161 344 1311 366">3RW4900-0KC00</p>

More information

For more information, refer to Catalog IC 10, Chapter 6 "Switching Devices – Soft Starters and Solid-State Switching Devices", Industry Mall or Interactive Catalog CA 01.

Overview

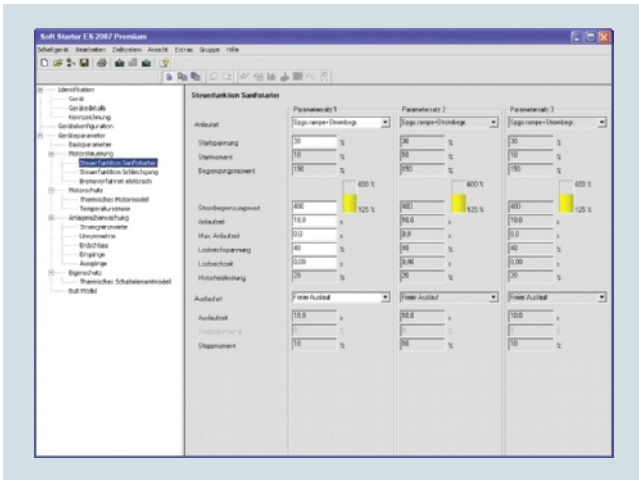

Easy and clearly arranged parameter setting of the 3RW44 soft starter with Soft Starter ES 2007

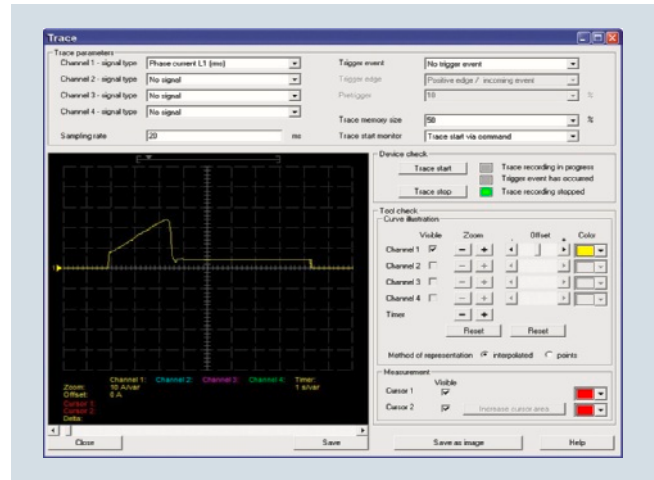

Graphic presentation of measured values with the trace function (oscilloscope function) of Soft Starter ES 2007 Standard and Premium

The Soft Starter ES software permits the quick and easy parameterization, monitoring and diagnostics of SIRIUS 3RW44 High-Feature soft starters for service purposes. The device parameters can be configured directly on the PC and transferred to the soft starter through a serial cable or an optional PROFIBUS/PROFINET interface.

Efficient engineering with three program versions

The Soft Starter ES software program is available in three versions which differ in their user-friendliness, scope of functions and price.

Soft Starter ES	Basic	Standard	Premium
Access through the local interface on the device	✓	✓	✓
Parameter assignment	✓	✓	✓
Operating	✓	✓	✓
Diagnostics	✓	✓	✓
Creation of typicals	--	✓ ¹⁾	✓
Parameter export	--	✓	✓
Comparison functions	--	✓	✓
Standard-compatible printout according to EN ISO 7200	--	✓	✓
Service data (slave pointer, statistics data)	--	✓	✓
Access through PROFIBUS/PROFINET	--	--	✓
Group functions	--	--	✓
Teleservice via MPI	--	--	✓
S7 routing	--	--	✓
STEP 7 Object Manager	--	--	✓

✓ Function available
-- Function not available

¹⁾ Typicals with Service Pack 1 and higher.

Additional functions

- **Standard-compliant printouts**
The software tool greatly simplifies machine documentation. It enables parameterization printouts according to EN ISO 7200. The elements to be printed are easy to select and group as required.
- **Easy creation of typicals**
Typicals can be created for devices and applications with only minimum differences in their parameters. These typicals contain all the parameters which are needed for the parameterization. In addition it is possible to specify which of these parameters are fixed and which can be adapted, e.g. by the startup engineer.
- **Group function**
For the user-friendly parameterization of numerous devices or applications of the same type, the programs of the SIRIUS ES software family offer a group function which enables the parameterization of several devices to be read out or written through PROFIBUS/PROFINET. In conjunction with typicals it is even possible to selectively adapt the same parameters in any number of parameterizations.
- **Teleservice via MPI**
The Soft Starter ES Premium version supports the use of MPI Teleservice (comprising the Teleservice software and various Teleservice adapters) for remote diagnostics of the devices. This facilitates diagnostics and maintenance, and it shortens response times for service purposes.

PROFIBUS

Soft starters
Software

Soft Starter ES

Overview (continued)

Types of delivery and license

Soft Starter ES is available as follows:

- Floating license – the license for any one user at any one time
 - Authorizes any one user
 - Independent of the number of installations (unlike the single license which is allowed to be installed once only)
 - Only the actual use of the program has to be licensed
 - Trial license (free use of all program functions for 14 days for test and evaluation purposes, included on every product CD, available in the download file of the SIRIUS ES program in the Service&Support portal).

Following delivery versions are available in addition for Soft Starter ES 2007:

- Upgrade
Switching from an old to a new version with expanded functions, e.g. upgrade from Soft Starter ES 2006 to Soft Starter ES 2007.
- Powerpack
Special pack for switching within the same software version to a more powerful version with more functionality, e.g. Powerpack Soft Starter ES 2007 for switching from Standard to Premium.

- Software Update Service
To keep you up to date at all times we offer a special service which supplies you automatically with all service packs and upgrades.
- License download
User-friendly license key download from our Mall (for selected countries) as an easy and quick way for you to receive additional licenses for your software.
For more information see www.siemens.com/tia-online-software-delivery.

Licensing procedure

To make licensing easier, the three versions of Soft Starter ES are available with the following license:

14 day trial license for Premium functions:
For test and evaluation purposes, included on every product CD, available also in the download file of the SIRIUS Soft Starter ES 2007 program in the Service&Support portal.

System requirements

Soft Starter ES 2007 parameterization, start-up and diagnostics software for SIRIUS 3RW44 soft starters	Basic/Standard	Premium
	Product version \geq *E04* ¹⁾	Product version \geq *E06* ²⁾
Operating system	Windows XP Professional (Service Pack 2 or 3), Windows 7 32/64-bit Professional/Ultimate/Enterprise (Service Pack 1)	
Processor	\geq Pentium 800 MHz/ \geq 1 GHz (Windows 7)	
RAM	\geq 512 MB (Windows XP Professional)/ \geq 1 GB (Windows 7 32-bit)/ \geq 2 GB (Windows 7 64-bit)	
Free space on hard disk	\geq 150 MB	
CD-ROM/DVD drive	Yes (only when installing from CD)	
Interface	Depends on PC cable: serial (COM) or USB	
PC cable/parameterization cable/connection cable	Yes	--
PROFIBUS/PROFINET communication module (optional)	--	Yes

¹⁾ SIRIUS 3RW44 with product version \geq *E04*. Installed in starters delivered after December 2005.

²⁾ SIRIUS 3RW44 with product version \geq *E06*. Installed in starters delivered after May 2006.

Benefits

- Transparent setting of the device functions and their parameters – online and offline
- Effective diagnostics functions on the soft starter and display of the most important measured values
- Trace function (oscilloscope function) for recording measured values and events (in the Soft Starter ES Standard and Premium versions)
- Complete transparency thanks to printout, logbook and event memory
- High degree of user-friendliness – convenient user interface, with German, English and French as possible operating languages
- Time savings through shorter startup times
- Fast, low-cost licensing using a simple licensing procedure (available online too)

Selection and ordering data
Soft Starter ES parameterization and service software for SIRIUS 3RW44 soft starters

- Delivered without PC cable

Version	Article No.
Soft Starter ES 2007 Basic	
 <p>Floating license for one user Engineering software in limited-function version for diagnostics purposes, software and documentation on CD, 3 languages (German/English/French), communication through system interface</p> <ul style="list-style-type: none"> • License key on USB stick, Class A, including CD • License key download, Class A, without CD 	<p>3ZS1313-4CC10-0YA5 3ZS1313-4CE10-0YB5</p>
Soft Starter ES 2007 Standard	
<p>Floating license for one user Engineering software, software and documentation on CD, 3 languages (German/English/French), communication through system interface</p> <ul style="list-style-type: none"> • License key on USB stick, Class A, including CD • License key download, Class A, without CD 	<p>3ZS1313-5CC10-0YA5 3ZS1313-5CE10-0YB5</p>
<p>Upgrade for Soft Starter ES 2006 Floating license for one user, engineering software, software and documentation on CD, license key on USB stick, Class A, 3 languages (German/English/French), communication through system interface</p>	<p>3ZS1313-5CC10-0YE5</p>
<p>Powerpack for Soft Starter ES 2007 Basic Floating license for one user, engineering software, license key on USB stick, Class A, 3 languages (German/English/French), communication through system interface</p>	<p>3ZS1313-5CC10-0YD5</p>
<p>Software Update Service For 1 year with automatic extension, assuming the current software version is in use, engineering software, software and documentation on CD, communication through system interface</p>	<p>3ZS1313-5CC10-0YL5</p>
Soft Starter ES 2007 Premium	
<p>Floating license for one user Engineering software, software and documentation on CD, 3 languages (German/English/French), communication through system interface or PROFIBUS/PROFINET, STEP7 Object Manager</p> <ul style="list-style-type: none"> • License key on USB stick, Class A, including CD • License key download, Class A, without CD 	<p>3ZS1313-6CC10-0YA5 3ZS1313-6CE10-0YB5</p>
<p>Upgrade for Soft Starter ES 2006 Floating license for one user, engineering software, software and documentation on CD, license key on USB stick, Class A, 3 languages (German/English/French), communication through system interface or PROFIBUS/PROFINET, STEP7 Object Manager</p>	<p>3ZS1313-6CC10-0YE5</p>
<p>Powerpack for Soft Starter ES 2007 Standard Floating license for one user, engineering software, license key on USB stick, Class A, 3 languages (German/English/French), communication through system interface or PROFIBUS/PROFINET, STEP7 Object Manager</p>	<p>3ZS1313-6CC10-0YD5</p>
<p>Software Update Service For 1 year with automatic extension, assuming the current software version is in use, engineering software, software and documentation on CD, communication through system interface or PROFIBUS/PROFINET, STEP7 Object Manager</p>	<p>3ZS1313-6CC10-0YL5</p>

Notes:

Please order PC cable separately, see page 3/266.



For description of the software versions see page 3/263.

PROFIBUS

Soft starters

Software

Soft Starter ES**Accessories**

	Version	Article No.
<i>Optional accessories</i>		
 <p data-bbox="130 542 295 563">3UF7940-0AA00-0</p>	<p data-bbox="375 378 534 400">RS 232 PC cables</p> <p data-bbox="375 404 941 451">For connecting to the serial interface of a PC/PG, for communication with Soft Starter ES through the system interface</p>	<p data-bbox="1157 378 1316 400">3UF7940-0AA00-0</p>
 <p data-bbox="130 542 295 563">3UF7941-0AA00-0</p>	<p data-bbox="375 485 518 506">USB PC cables</p> <p data-bbox="375 510 941 557">For connecting to the USB interface of a PC/PG, for communication with Soft Starter ES through the system interface</p>	<p data-bbox="1157 485 1316 506">3UF7941-0AA00-0</p>
 <p data-bbox="130 670 295 691">3UF7946-0AA00-0</p>	<p data-bbox="375 591 550 612">USB/serial adapters</p> <p data-bbox="375 617 925 663">For connecting an RS 232 PC cable to the USB interface of a PC, use recommended in conjunction with Soft Starter ES</p>	<p data-bbox="1157 591 1316 612">3UF7946-0AA00-0</p>
	<p data-bbox="375 697 933 719">Optional PROFIBUS communication module for SIRIUS 3RW44</p>	<p data-bbox="1157 697 1300 719">3RW4900-0KC00</p>
	<p data-bbox="375 804 933 825">Optional PROFINET communication module for SIRIUS 3RW44</p>	<p data-bbox="1157 804 1300 825">3RW4900-0NC00</p>

3

Overview

The SIRIUS 3RW44 Soft Starter PCS 7 block library can be used for simple and easy integration of SIRIUS 3RW44 soft starters into the SIMATIC PCS 7 process control system. The SIRIUS 3RW44 Soft Starter PCS 7 block library contains the diagnostics and driver blocks corresponding with the SIMATIC PCS 7 diagnostics and driver concept as well as the elements (symbols and faceplates) required for operator control and process monitoring.

Integrated functionality for optimal process control for all process control systems

In addition to the general sensor technology, the motor feeder data is increasingly being integrated into the process control system. By integrating the SIRIUS 3RW44 soft starters into the process control system it becomes possible to prevent errors in the motor feeder simply and reliably, or to detect these errors quickly and rectify them. Downtimes are reduced to a minimum or can be prevented before they happen.

For example, the output and display of the key measured values calculated by the 3RW44 is also a good aid for being able to assess and monitor the current system status.

Easy integration with the PCS 7 block library

The PCS 7 block library can be used for simple and easy integration of SIRIUS 3RW44 soft starters into the SIMATIC PCS 7 process control system. The focus here is simple configuration. The function of the blocks is based on the PCS 7 standard libraries and is optimally harmonized with the functions of the SIRIUS 3RW44.

Users who have previously integrated conventional motor feeders via signal blocks and motor or valve blocks or, for example, already have experience with SIMOCODE blocks, are easily able to switch to SIRIUS 3RW44.

All blocks required for the automation systems are provided by the PCS 7 block library – as are the block symbols and faceplates for the operator station required for monitoring and control.

With the integration of the SIRIUS 3RW44 into SIMATIC PDM, the system-wide device parameterization and diagnostics of the SIRIUS 3RW44 soft starters are possible from a central point.

Motor block for the direct control of the drive

The low-voltage motors started and protected by SIRIUS 3RW44 soft starters can be integrated into the process automation via the motor blocks. This means that they form the interface between the process control system and the motors controlled by the SIRIUS 3RW44.

To reduce the amount of configuring work required, functions for signal processing and technological functions are integrated into one motor block.

The important measured value – the current in the motor feeder – is recorded via the 3RW44 and monitored for motor protection. The motor current is accessible from the I&C system via the motor blocks.

The block symbols and faceplates for the motor blocks display the motor feeders on the operator station and provide all the required information for monitoring and control as well as detailed diagnostics.

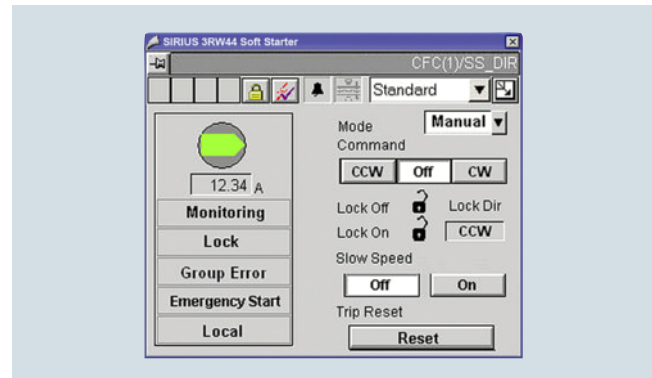

Faceplate of the motor block

Evaluation of additional motor feeder measurements

All measured values calculated by the soft starter, such as current, voltage and output of the feeder, are displayed and output via the measured value blocks. A key advantage here is that where required, a wide range of information on important motor feeder measurements is available, e.g. for load monitoring.

The 3RW44 is not only able to detect measured values here, but also to react if these values are exceeded or undershot, for example, via custom settings – e.g. with a motor disconnection or with a warning.

The faceplate for the measured values is accessed from the motor block faceplate.

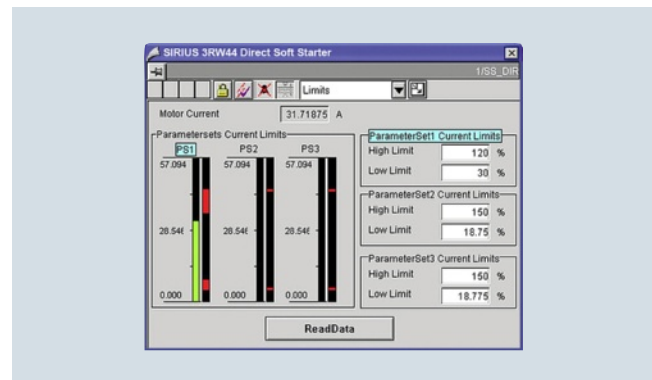

Faceplate for measured values

Evaluation of maintenance-related motor feeder data

The 3RW44 has powerful functions to detect and monitor maintenance-related motor feeder data. For example, the operating and downtimes of the motor, operating cycles and overload tripping events are detected and stored directly on the device. If required, the information already on the device is available via the statistics block in the I&C system. The display is provided on a separate faceplate for the statistics block on the operator station.

Types of delivery and license

The SIRIUS 3RW44 soft starter PCS 7 block library supplied on CD-ROM allows the user to run the required engineering software on the engineering station (single license) including the runtime software for executing the AS blocks in an automation system (single license). If the AS blocks are to be used in additional automation systems, the corresponding number of runtime licenses are required which are supplied without a data carrier.

PROFIBUS

Soft starters

Software

SIRIUS 3RW44 Soft Starter block library for SIMATIC PCS 7**Benefits**

- Uniform and continuous integration into SIMATIC PCS 7
- Standardized blocks for simple integration and optimal operation
- Including Advanced Process Library (APL) in Version V8
- Greater process transparency due to greater information density in the process control system
- System-wide device parameterization and diagnostics with SIMATIC PDM

Selection and ordering data

Version	Article No.
<p><i>SIRIUS 3RW44 soft starter block library for SIMATIC PCS 7, Version V8 with Advanced Process Library (APL)</i></p>  <p>Engineering software V8 For one engineering station (single license) including runtime software for execution of the AS blocks in an automation system (single license), German/English Scope of supply: AS blocks and faceplates for integrating SIRIUS 3RW44 into the PCS 7 process control system with Advanced Process Library, for PCS 7 version V8.0 Type of delivery: Software and documentation on CD, one license for one engineering station, one license for one automation system</p>	3ZS1633-1XX02-0YA0
<p>Runtime license V8 for execution of the AS blocks in an automation system (single license) Required for using the AS blocks of the engineering software V8 on an additional automation system within a plant Type of delivery: One license for one automation system, without software and documentation</p>	3ZS1633-2XX02-0YB0
<p>Upgrade for SIRIUS 3RW44 PCS 7 block library, V6.0 or V7 to version SIRIUS 3RW44 V8 For one engineering station (single license) including runtime software for execution of the AS blocks in an automation system (single license), German/English Scope of supply: AS blocks and faceplates for integrating SIRIUS 3RW44 into the PCS 7 process control system with Advanced Process Library for PCS 7 version V8.0 Type of delivery: Software and documentation on CD, one license for one engineering station, one license for one automation system</p>	3ZS1633-1XX02-0YE0

3ZS1633-1XX02-0YA0

3

SIRIUS 3RW44 Soft Starter block library for SIMATIC PCS 7
Selection and ordering data (continued)

	Version	Article No.
SIRIUS 3RW44 soft starter block library for SIMATIC PCS 7 Version V7		
 3ZS1633-1XX00-0YA0	Engineering software V7 For one engineering station (single license) including runtime software for execution of the AS blocks in an automation system (single license), German/English Scope of supply: AS blocks and faceplates for integrating SIRIUS 3RW44 into the PCS 7 process control system, for PCS 7 version V6.1/V7.0/V7.1 ¹⁾ Type of delivery: Software and documentation on CD, one license for one engineering station, one license for one automation system	3ZS1633-1XX00-0YA0
	Runtime license V7 For execution of the AS blocks in an automation system (single license) Required for using the AS blocks of the engineering software V7 or the engineering software migration V7-V8 on an additional automation system within a plant Type of delivery: One license for one automation system, without software and documentation	3ZS1633-2XX00-0YB0
	Engineering software migration V7-V8 For upgrading (migrating) an existing engineering software V6.1/V7.0/V7.1 of the SIRIUS 3RW44 soft starter block library for PCS 7 Conditions of use: Availability of the engineering software V7 (license) of the SIRIUS 3RW44 soft starter block library for PCS 7 for the PCS 7 version V6.1, V7.0 or V7.1 The engineering software migration V7-V8 can be installed directly onto a system with PCS 7 version V8.0; installation of the previous version is unnecessary. For one engineering station (single license) including runtime software for execution of the AS blocks in an automation system (single license), German/English Scope of supply: AS blocks and faceplates for integrating SIRIUS 3RW44 soft starters into the PCS 7 process control system, for PCS 7 version V8.0 Type of delivery: Software and documentation on CD, license for upgrading an existing license for one engineering station and a plant's assigned runtime licenses	3ZS1633-1XX10-0YE0

¹⁾ For earlier versions of the engineering software, SP1 can be downloaded from www.siemens.com/sirius-engineering.

More information

For Programming and Operating Manual for PCS 7 Block Library for SIRIUS Soft Starter 3RW44 V6.1/V7.0 + SP2 see <http://support.automation.siemens.com/WW/view/en/41856585>.

For Getting Started for PCS 7 Block Library for SIRIUS 3RW44 Soft Starter V6.1/V7.0 + SP2 see <http://support.automation.siemens.com/WW/view/en/41856498>.

Note:

Programming Manual and GETTING STARTED are valid for engineering software V7 and engineering software migration V7-V8.

PROFIBUS

Motor starters for use in the field, high degree of protection

M200D motor starters for PROFIBUS

Overview

The intelligent, highly flexible M200D PROFIBUS/PROFINET motor starters have the broadest range of functions of all products in the SIRIUS motor starter family in the high degree of protection IP65 for PROFIBUS/PROFINET communication.

They start and protect motors and loads up to 5.5 kW. Direct-on-line and reversing starter variants are available in a mechanical version and also an electronic version (the latter with soft start function).

The particularly robust M200D PROFIBUS/PROFINET motor starters are characterized by numerous functions which can be flexibly parameterized. Their modular design comprises a motor starter module and a communication module.

The M200D PROFINET motor starters enable TIA-integrated parameterization through PROFINET from STEP 7 – in familiar, user-friendly manner with the same look-and-feel as PROFIBUS.

Functionality

- Basic functionality see Chapter 4 "AS-Interface" → "M200D Motor Starters" → "General Data" → "Overview"
- Electronic version also with soft start function
- Robust and widely used M12 connection method for the digital inputs and outputs and the PROFIBUS/PROFINET bus connection
- All four digital inputs and two digital outputs also exist in the cyclic process image. This provides complete transparency of the process on the control level
- Full TIA integration: All digital inputs and outputs exist in the cyclic process image and are visible through the bus, providing maximum flexibility and excellent adaptability to the application
- Flexible assignment of the digital inputs and outputs with all available assignable input actions
- Extensive diagnostics concept using LEDs and through the bus with the TIA-compatible mechanisms
- Expanded diagnostics using data records
- Complete plant monitoring using statistics data record and current value monitoring by means of data records
- Parameterization through PROFIBUS/PROFINET bus with the help of data records from the user program
- Control of the motor starter using a command data record from the user program
- Removable modular control unit – quicker device replacement and therefore lower costs when device outages occur – since existing wiring is on the control unit and only one device needs to be replaced
- Parameterization in STEP 7 HW Config using Motor Starter ES (ordering option for start-up software)
- Start-up and diagnostics with the help of Motor Starter ES (ordering option for start-up software)
- Trace function through Motor Starter ES for optimized start-up and tracking of process and device values



M200D motor starter modules for PROFIBUS/PROFINET (without communication module)



M200D communication modules for PROFIBUS

Mounting and installation

The M200D PROFIBUS/PROFINET motor starter is comprised of a communication module and a motor starter module. Only the motor starter module has to be replaced therefore when replacing devices. This saves time and money. The communication module remains as an active station on the bus and all other system components continue running. This prevents downtimes.

The integrated plug-in technology enables far lower wiring outlay: Connecting cables can be plugged directly onto the motor starter module. The PROFINET bus is connected cost-effectively using an M12 connection on the device. All versions have identical enclosure dimensions for easier system design and conversion.

Overview (continued)Parameterization and configuration

All motor protection functions, limit values and reactions can be defined by parameterization.

The user has several user-friendly options for the parameterization. In addition to parameterization directly from STEP 7, which also permits automatic re-parameterization in case of device replacement, it is possible to use the user-friendly Motor Starter ES start-up software. By connecting a programming device directly to PROFIBUS/PROFINET and the Motor Starter ES start-up software, the devices can also be conveniently programmed from a central point through the bus. Also, parameters can be changed during operation from the user program using the data record

mechanism so that the function of the motor starter is adapted to the process when required. With the help of a PC and the Motor Starter ES software it is also possible to perform the parameterization through the local point-to-point interface on-site.

Functions can be flexibly assigned to the digital inputs and outputs, adapting them to all possible conveyor applications. All digital inputs and outputs exist in the cyclic process image. All limit values for monitoring functions and their reactions are parameterizable and therefore adaptable to the application. Consistency with other products of the SIRIUS M200D motor starter range and with the frequency converter and ET 200pro peripherals system is assured.



SIRIUS M200D
PROFIBUS



SIRIUS M200D
PROFINET

Device functions (firmware features)**Slave on the bus**

Fieldbus	✓ PROFIBUS to M12	✓ PROFINET to M12
Adjustable number of stations	✓ 1 ... 125	✓ 1 ... 128 with CPU 315, CPU 317 1 ... 1 256 with CPU 319

Parameterization

DIP switches	✓ For address setting and terminating resistor	--
Motor Starter ES	✓ Through bus, optical interface	
PROFIBUS/PROFINET data records	✓	
From STEP 7 / HW Config	✓	

Diagnostics

Acyclic through data records	✓
Diagnostic interrupt support	✓

Process image

Process image	✓ 2Byte PII/ 2Byte PIQ
---------------	------------------------

Data channels

Local optical interface (manual local)	✓
Through Motor Starter ES local interface	✓
Using Motor Starter ES through bus	✓

Data records (acyclic)

Parameterization	✓ Using DS 131 (DS = data record)	
Diagnostics	✓ Device-specific DS 92	
Measured values	✓ Measured values DS 94	
Statistics	✓ Statistical data DS 95	
Commands	✓ Using DS 93	
Slave pointer	✓ Slave pointer DS 96	
Logbook	✓ Using Motor Starter ES and data records: Device faults DS 72, tripping operations DS 73, events DS 75	
Device identification	✓ Using DS 100	
I&M data	✓ Using DS 231 ... 234	✓ Using data records 0xAFF0 ... 0xAFF3

Inputs

Number	✓ 4
• Of which in the process image	✓ 4
Input action	✓ Parameterizable: flexibly assignable action, see manual
Quick stop	✓ Parameterizable: latching, non-latching

✓ Function available

-- Function not available

PROFIBUS

Motor starters for use in the field, high degree of protection

M200D motor starters for PROFIBUS

Overview (continued)



SIRIUS M200D
PROFIBUS



SIRIUS M200D
PROFINET

Device functions (firmware features)

Outputs

Number	✓ 2
• Of which in the process image	✓ 2
Output action	✓ Parameterizable: flexibly assignable action, see manual

Brake output

180 V DC / 230/400 V AC / none

✓

Motor protection

Overload protection	✓ Electronic, wide range 1:10
Short-circuit protection	✓
Full motor protection	✓
Temperature sensor	✓ Parameterizable using Motor Starter ES, data record: PTC or Thermoclick or deactivated

Device function

Repair switch	✓
Lower current limit monitoring	✓ Parameterizable
Upper current limit monitoring	✓ Parameterizable
Zero current detection	✓ Parameterizable: tripping, warning
Blocking current	✓ Parameterizable
Unbalance	✓ Parameterizable
Load type	✓ Parameterizable: 1 and 3-phase
Tripping class	✓ Parameterizable using Motor Starter ES, data record: CLASS 5, 10, 15, 20
Protection against voltage failure	✓ Parameterizable: activated/deactivated

Support for PROFlenergy profile

Switching during dead times	--	✓
Measured motor current values	--	✓

Soft starter control function

Soft start function	✓
Bypass function	✓ Only solid-state version

✓ Function available

-- Function not available

Application

The M200D PROFIBUS/PROFINET motor starters are particularly suitable for fully TIA-integrated, highly automated conveyor applications which meet all needs with regard to the monitoring of devices and systems and preventative maintenance.

Adaptability of the motor starter functions and maximum flexibility of the device enable a broad range of applications without any limits. The PROFINET-specific expansions are the best assurance of a future-proof investment.

Selection and ordering data



M200D motor starter module
M200D PROFIBUS
(without communication module)

PROFIBUS/PROFINET
motor starter

Version	Article No.
<i>M200D communication modules for PROFIBUS</i>	
Communication modules for PROFIBUS M12 termination 7/8"	3RK1305-0AS01-0AA0
<i>M200D PROFIBUS/PROFINET motor starter modules</i> <i>Electromechanical starters (with integrated contactor)</i>	3RK1395-6 ■ S41- ■ AD ■
Setting range for rated operational current / A	
• 0.15 ... 2	K
• 1.5 ... 12	L
Direct-on-line starters/reversing starters	
• Direct-on-line starters	0
• Reversing starters	1
• Direct-on-line starters with manual local operation	2
• Reversing starters with manual local operation	3
Brake actuation	
• Without brake actuation	0
• Brake actuation (230/400 V AC)	3
• Brake actuation (180 V DC)	5

Version	Article No.
<i>Electronic starters (with thyristors)</i>	3RK1395-6 ■ S71- ■ AD ■
Setting range for rated operational current / A	
• 0.15 ... 2	K
• 1.5 ... 12	L
Direct-on-line starters/reversing starters	
• Direct-on-line starters	0
• Reversing starters	1
• Direct-on-line starters with manual local operation	2
• Reversing starters with manual local operation	3
Brake actuation	
• Without brake actuation	0
• Brake actuation (230/400 V AC)	3
• Brake actuation (180 V DC)	5



PROFIBUS

Motor starters for use in the field, high degree of protection

M200D motor starters for PROFIBUS

M200D motor starters for PROFIBUS > Accessories



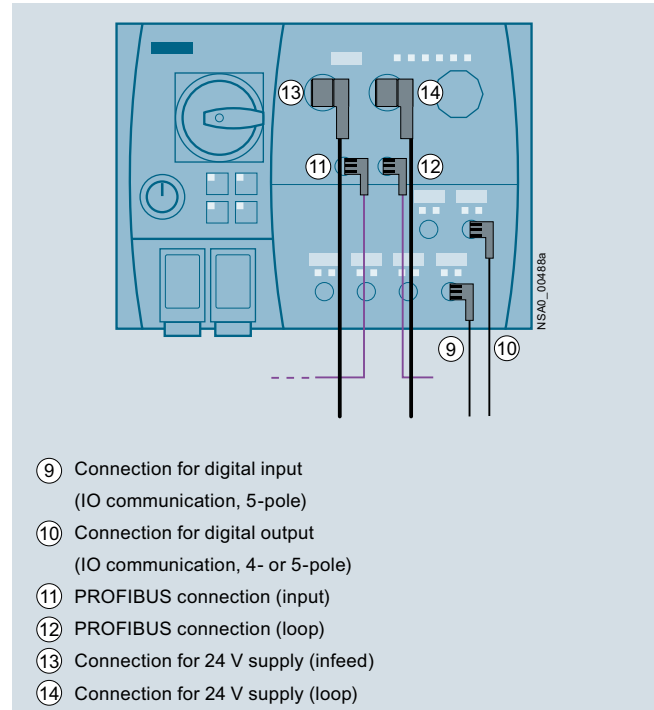

Overview

For accessories for all SIRIUS M200D motor starters (irrespective of the communication connection) see Chapter 4 "AS-Interface" ⇒ "SIRIUS M200D Motor Starters" ⇒ "Accessories"







Communication connection using PROFIBUS and digital inputs and outputs

Selection and ordering data

Version	Article No.
Motor control with PROFIBUS	
 <p>M12 plugs, angled Screw fixing, 5-pole screw terminals, max. 0.75 mm², B-coded, no terminating resistor</p> <ul style="list-style-type: none"> ⑪ 5 female contacts <p>3RK1902-1DA00</p>	<p>3RK1902-1DA00</p> <p>3RK902-1BA00</p>
 <ul style="list-style-type: none"> ⑫ 5 male contacts <p>3RK1902-1BA00</p>	
 <p>Control cables, assembled at one end M12, screw fixing, angular, B coded, no terminating resistor</p> <ul style="list-style-type: none"> ⑪ 5 female contacts, 3 m ⑫ 5 female contacts, 5 m ⑬ 5 female contacts, 10 m <p>3RK1902-1G.</p>	<p>3RK1902-1GB30</p> <p>3RK1902-1GB50</p> <p>3RK1902-1GC10</p>
 <p>⑪ ⑫ Control cables, assembled at both ends M12, screw fixing, angular, pin/socket 5-pole, B-coded, no terminating resistor</p> <ul style="list-style-type: none"> • 3.0 m • 5.0 m • 10.0 m <p>3RK1902-1N.</p>	<p>3RK1902-1NB30</p> <p>3RK1902-1NB50</p> <p>3RK1902-1NC10</p>

Selection and ordering data (continued)

Version	Article No.
Further accessories	
PROFIBUS trailing cables Max. acceleration 4 m/s ² , at least 3 000 000 bending cycles, bending radius at least 60 mm, 2-core, shielded, sold by the meter, minimum order quantity 20 m, maximum order quantity 1 000 m	6XV1830-3EH10
PROFIBUS FC Food bus cables With PE outer sheath for operation in the food and beverage industry, 2-core, shielded, sold by the meter, minimum order quantity 20 m, maximum order quantity 1 000 m	6XV1830-0GH10
PROFIBUS FC Robust bus cables With PUR outer sheath for operation in environments exposed to chemicals and mechanical loads, 2-core, shielded, sold by the meter, minimum order quantity 20 m, maximum order quantity 1 000 m	6XV1830-0JH10
Power cables 5-core, 5 x 1.5 mm ² , trailing, sold by the meter, minimum order quantity 20 m, maximum order quantity 1 000 m	6XV1830-8AH10
Connection for 24 V power supply of the M200D PROFIBUS/PROFINET	
 3RK1902-3DA00	Plugs On M200D, 7/8" for screw fixing, angular, screw terminal, 1.5 mm ² <ul style="list-style-type: none"> Ⓜ 5 female contacts
 3RK1902-3BA00	
 3RK1902-3G.	Ⓜ Supply lines, assembled at one end 7/8" for screw fixing, angular, 1.5 mm ² <ul style="list-style-type: none"> 5 female contacts, 3 m 5 female contacts, 5 m 5 female contacts, 10 m
 3RK1902-3N.	Ⓜ Ⓜ Supply lines, assembled at both ends 7/8" for screw fixing, angular at both ends, 5-pole pin/socket, 1.5 mm ² <ul style="list-style-type: none"> 3 m 5 m 10 m
 6ES7194-3JA00-0AA0	7/8" sealing caps 1 pack = 10 units

PROFIBUS

Motor starters for use in the field, high degree of protection
Software

Motor Starter ES

Overview

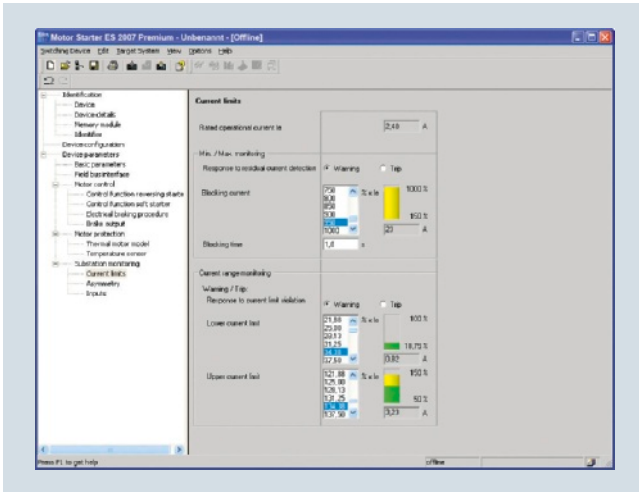

Motor Starter ES for parameterization, monitoring, diagnostics and testing of motor starters

Motor Starter ES is used for start-up, parameterization, diagnostics, documentation and the preventative maintenance of the motor starters in the SIMATIC ET 200S, ET 200pro, ECOFAST and M200D product families.

Interfacing is performed

- Through the local interface on the device
- With PROFIBUS DP V1 capable motor starters from any point in PROFIBUS or in PROFINET (applies to ET 200S DP V1/ ET 200pro/ECOFAST/M200D)
- with PROFINET-capable motor starters from any point in PROFINET or in PROFIBUS (applies to ET 200S DP V1, ET 200pro/M200D)

Using Motor Starter ES, the communication-capable motor starters are easily parameterized during start-up, monitored during normal operation and successfully diagnosed for service purposes. Preventative maintenance is supported by a function for reading out diverse statistical data (e. g. operating hours, operating cycles, cut-off currents, etc.). The user is supported during these procedures with comprehensive Help functions and plain text displays.

Motor Starter ES can either be used as a stand-alone program or it can be integrated into STEP 7 via an Object Manager.

Efficient engineering with three program versions

The Motor Starter ES software program is available in three versions which differ in their user-friendliness, scope of functions and price.

Motor Starter ES	Basic	Standard	Premium
ET 200S High-Feature PROFIBUS IM	✓	✓	✓
ET 200S High-Feature PROFINET IM	✓	✓	✓
ECOFAST AS-Interface High-Feature	✓	✓	--
ECOFAST PROFIBUS	✓	✓	✓
ET 200pro PROFIBUS IM	✓	✓	✓
ET 200pro PROFINET IM	✓	✓	✓
M200D AS-Interface Standard	✓	✓	(✓)
M200D PROFIBUS	✓	✓	✓
M200D PROFINET	✓	✓	✓

- ✓ Function available, (✓) available with restricted functionality
- Function not available

Motor Starter ES	Basic	Standard	Premium
Access through the local interface on the device	✓	✓	✓
Parameter assignment	✓	✓	✓
Operating	✓	✓	✓
Diagnostics	--	✓	✓
Creation of typicals	--	✓	✓
Comparison functions	--	✓	✓
Standard-compliant printout according to EN ISO 7200	--	✓	✓
Service data (slave pointer, statistics data)	--	✓	✓
Access via PROFIBUS	--	--	✓
Access via PROFINET	--	--	✓
S7 routing	--	--	✓
Teleservice via MPI	--	--	✓
STEP 7 Object Manager	--	--	✓
Trace function	--	✓	✓

- ✓ Function available
- Function not available

Additional functions

- Standard-compliant printouts
The software tool greatly simplifies machine documentation. It enables parameterization printouts according to EN ISO 7200. The elements to be printed are easy to select and group as required.
- Easy creation of typicals
Typicals can be created for devices and applications with only minimum differences in their parameters. These typicals contain all the parameters which are needed for the parameterization. In addition it is possible to specify which of these parameters are fixed and which can be adapted, e.g. by the startup engineer.
- Teleservice via MPI
The Motor Starter ES Premium version supports the use of MPI Teleservice (comprising the Teleservice software and various Teleservice adapters) for remote diagnostics of the devices. This facilitates diagnostics and maintenance, and it shortens response times for service purposes.

Overview (continued)**Types of delivery and license**

Motor Starter ES is available as follows:

- Floating license – the license for any one user at any one time
 - Authorizes any one user
 - Independent of the number of installations (unlike the single license which is allowed to be installed once only)
 - Only the actual use of the program has to be licensed
 - Trial license (free use of all program functions for 14 days for test and evaluation purposes, included on every product CD, available in the download file of the SIRIUS ES program in the Service&Support portal)

Following delivery versions are also available for Motor Starter ES 2007:

- Upgrade
Switching from an old to a new version with expanded functions, e.g. upgrade from Motor Starter ES 2006 to Motor Starter ES 2007.
- Powerpack
Special pack for switching within the same software version to a more powerful version with more functionality, e.g. Powerpack Motor Starter ES 2007 for switching from Standard to Premium.
- Software Update Service
To keep you up to date at all times we offer a special service which supplies you automatically with all service packs and upgrades.
- License download
User-friendly license key download from our Mall (for selected countries) as an easy and quick way for you to receive additional licenses for your software.
For more information see www.siemens.com/tia-online-software-delivery.

System requirements

Parameterization, start-up and diagnostics software Motor Starter ES 2007	For ECOFAST motor starters, SIMATIC ET 200S High-Feature starters, SIMATIC ET 200pro starters, and M200D (AS-I standard, PROFIBUS, PROFINET)
Operating system	Windows XP Professional (Service Pack 2 or 3) Windows 7 32/64-bit Professional/Ultimate/Enterprise (Service Pack 1)
Processor	≥ Pentium 800 MHz/≥ 1 GHz (Windows 7)
RAM	≥ 512 MB (Windows XP Professional)/≥ 1 GB (Windows 7 32-bit)/ ≥ 2 GB (Windows 7 64-bit)
Monitor resolution	≥ 1 024 x 768
Free space on hard disk¹⁾	≥ 400 MB
CD-ROM/DVD drive	Yes (only when installing from CD)
Interface	Depends on PC cable: serial (COM) or USB
PC cable/parameterization cable/connection cable	Yes
PROFIBUS card/PROFIBUS processor	Optional, for parameterization and diagnostics through PROFIBUS
Ethernet interface/PROFINET card	Optional, for parameterization and diagnostics through PROFINET

¹⁾ Additional free space recommended, e.g. for swap-out file.

Benefits

- Fast, error-free configuration and startup of motor starters even without extensive previous knowledge
- Transparent setting of the device functions and their parameters – online and offline
- Effective diagnostics functions on the soft starter and display of the most important measured values
- Trace function (oscilloscope function) for recording measured values and events (included in the Motor Starter ES Standard and Premium software versions for M200D PROFIBUS and PROFINET).

PROFIBUS

Motor starters for use in the field, high degree of protection
Software

Motor Starter ES

Selection and ordering data

Parameterization, start-up and diagnostics software Motor Starter ES 2007

For ECOFAST motor starters, SIMATIC ET 200S
High-Feature starters, SIMATIC ET 200pro starters,
and M200D (AS-I standard, PROFIBUS, PROFINET)

Version	Article No.
Motor Starter ES 2007 Basic	
 <p>Floating license for one user Engineering software in limited-function version for diagnostics purposes, software and documentation on CD, 3 languages (German/English/French), communication through system interface</p> <ul style="list-style-type: none"> • License key on USB stick, Class A, including CD • License key download, Class A, without CD 	<p>3ZS1310-4CC10-0YA5 3ZS1310-4CE10-0YB5</p>
Motor Starter ES 2007 Standard	
<p>Floating license for one user Engineering software, software and documentation on CD, 3 languages (German/English/French), communication through system interface</p> <ul style="list-style-type: none"> • License key on USB stick, Class A, including CD • License key download, Class A, without CD 	<p>3ZS1310-5CC10-0YA5 3ZS1310-5CE10-0YB5</p>
<p>Upgrade for Motor Starter ES 2006 Floating license for one user, engineering software, software and documentation on CD, license key on USB stick, Class A, 3 languages (German/English/French), communication through system interface</p>	3ZS1310-5CC10-0YE5
<p>Powerpack for Motor Starter ES 2007 Basic Floating license for one user, engineering software, license key on USB stick, Class A, 3 languages (German/English/French), communication through system interface</p>	3ZS1310-5CC10-0YD5
<p>Software Update Service For 1 year with automatic extension, assuming the current software version is in use, engineering software, software and documentation on CD, communication through system interface</p>	3ZS1310-5CC10-0YL5
Motor Starter ES 2007 Premium	
<p>Floating license for one user Engineering software, software and documentation on CD, 3 languages (German/English/French), communication through system interface or PROFIBUS/PROFINET, STEP7 Object Manager</p> <ul style="list-style-type: none"> • License key on USB stick, Class A, including CD • License key download, Class A, without CD 	<p>3ZS1310-6CC10-0YA5 3ZS1310-6CE10-0YB5</p>
<p>Upgrade for Motor Starter ES 2006 Floating license for one user, engineering software, software and documentation on CD, license key on USB stick, Class A, 3 languages (German/English/French), communication through system interface or PROFIBUS/PROFINET, STEP7 Object Manager</p>	3ZS1310-6CC10-0YE5
<p>Powerpack for Motor Starter ES 2007 Standard Floating license for one user, engineering software, license key on USB stick, Class A, 3 languages (German/English/French), communication through system interface or PROFIBUS/PROFINET, STEP7 Object Manager</p>	3ZS1310-6CC10-0YD5
<p>Software Update Service For 1 year with automatic extension, assuming the current software version is in use, engineering software, software and documentation on CD, communication through the system interface or PROFIBUS/PROFINET, STEP7 Object Manager</p>	3ZS1310-6CC10-0YL5

Notes:

Please order PC cable separately, see page 3/279.

For description of the software versions see page 3/276.

Accessories

	Version	Article No.
<i>Optional accessories</i>		
 <p>3RK1903-0CH20</p>	<p>2DI LC COM control module For ET 200S High-Feature starters, fail-safe starters A</p>	<p>3RK1903-0CH20</p>
	<p>LOGO! USB PC cables For ET 200S High-Feature starter</p>	<p>6ED1057-1AA01-0BA0</p>
	<p>RS 232 interface cable Serial data connection between ET 200pro MS/FC, M200D and laptop/PC/PG or MS</p>	<p>3RK1922-2BP00</p>
	<p>USB interface cable Serial data connection between ET 200pro MS/FC, M200D and laptop/PC/PG or MS</p>	<p>6SL3555-0PA00-2AA0</p>
	<p>USB/serial adapters for connecting an RS 232 PC cable to the USB interface of a PC, recommended for use in conjunction with ET 200S/ECOFAS/ET 200pro motor starters</p>	<p>3UF7946-0AA00-0</p>

PROFIBUS

Motor starters for use in the field, high degree of protection
Software

SIRIUS motor starter block library for SIMATIC PCS 7

Overview

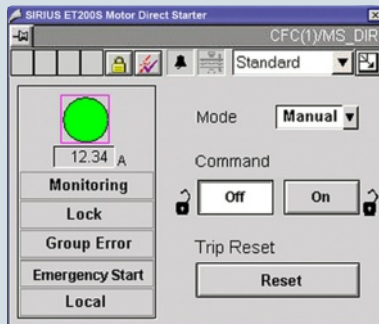

Faceplate of the motor block

With the SIRIUS motor starter PCS 7 block library, SIRIUS ET 200S and ET 200pro motor starters can be easily and simply integrated into the SIMATIC PCS 7 process control system. The SIRIUS motor starter PCS 7 block library contains the diagnostics and driver blocks corresponding to the SIMATIC PCS 7 diagnostics and driver concept as well as the elements (symbols and faceplates) required for operator control and process monitoring.

Easy integration with the PCS 7 block library

The PCS 7 block library can be used for simple and easy integration of SIRIUS ET 200S and ET 200pro motor starters into the SIMATIC PCS 7 process control system V7.0, V7.1 and V8.0. The focus here is simple configuration. The function of the blocks is based on the PCS 7 standard libraries and is optimally harmonized with the functions of the SIRIUS motor starters.

Users who have previously integrated conventional motor feeders into PCS 7 are easily able to switch to SIRIUS motor starters.

All blocks required for the automation systems are provided by the PCS 7 block library – as are the block symbols and faceplates for the operator station required for monitoring and control.

Regardless of whether, for example, the motor starter is controlled directly, or its current value is to be read out and status, warning and error signals are to be displayed, the right blocks are always available.

Connection to powerrate

The SIRIUS motor starters can be connected to powerrate. The block provides the possibility of integrating the motor starters into energy management.

The current values are supplied directly from the motor starter block, while the voltage and the power factor (p.f) must be entered manually.

Types of delivery and license

The SIRIUS motor starter PCS 7 block library supplied on CD-ROM allows the user to run the required engineering software on the engineering station (single license) including the runtime software for executing the AS blocks in an automation system (single license). If the AS blocks are to be used in additional automation systems, the corresponding number of runtime licenses are required which are supplied without a data carrier.

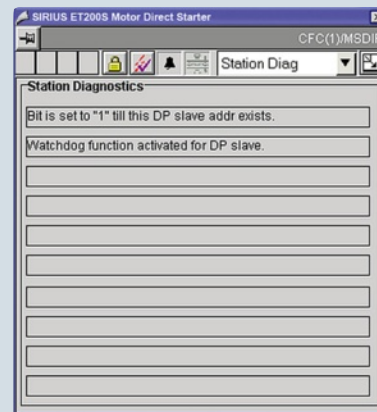

Faceplate for diagnostics

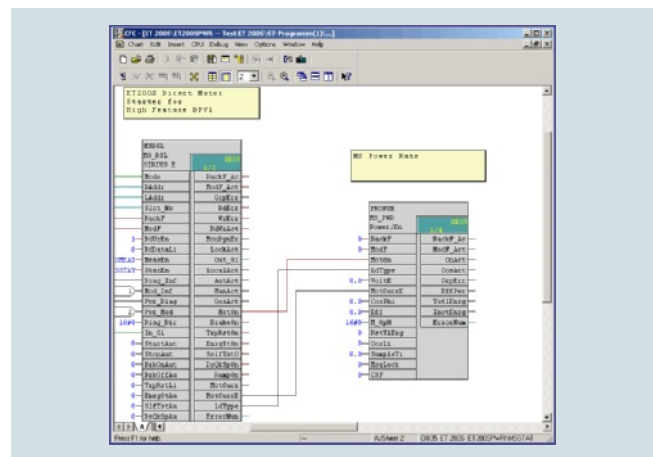

Faceplate for energy management with powerrate

Benefits

- Uniform and continuous integration into SIMATIC PCS 7
- Standardized blocks for simple integration and optimal operation
- Greater process transparency due to greater information density in the process control system

Selection and ordering data

Version	Article No.
<i>SIRIUS motor starter block library for SIMATIC PCS 7</i>	
 <p>3ZS1630-1XX00-0YA0</p>	<p>Engineering software V7 For one engineering station (single license) including runtime software for execution of the AS blocks in an automation system (single license), German/English Scope of supply: AS blocks and faceplates for integrating SIRIUS motor starters into the PCS 7 process control system, for PCS 7 version V7.0 or V7.1 Type of delivery: Software and documentation on CD, one license for one engineering station, one license for one automation system</p>
	<p>Runtime license V7 For execution of the AS blocks in an automation system (single license) Required for using the AS blocks of the engineering software V7 or the engineering software migration V7-V8 on an additional automation system within a plant Type of delivery: One license for one automation system, without software and documentation</p>
	<p>Upgrade for SIRIUS motor starter block library for SIMATIC PCS 7 V6.1/V7.0 to V7.0/V7.1 For one engineering station (single license) including runtime software for execution of the AS blocks in an automation system (single license), German/English Scope of supply: AS blocks and faceplates for integrating SIRIUS motor starter into the PCS 7 process control system, for PCS 7 version V7.0 or V7.1 Type of delivery: Software and documentation on CD, one license for one engineering station, one license for one automation system</p>
	<p>Engineering software migration V7-V8 For upgrading (migrating) an existing engineering software V7 of the SIRIUS motor starter block library for PCS 7 Conditions of use: Availability of the engineering software V7 (license) of the SIRIUS motor starter block library for PCS 7 for the PCS 7 version V7.0 or V7.1 The engineering software migration V7-V8 can be installed directly onto a system with PCS 7 version V8.0; installation of the previous version is unnecessary. For one engineering station (single license) including runtime software for execution of the AS blocks in an automation system (single license), German/English Scope of supply: AS blocks and faceplates for integrating SIRIUS motor starter into the PCS 7 process control system, for PCS 7 version V8.0 Type of delivery: Software and documentation on CD, license for upgrading an existing license for one engineering station and a plant's assigned runtime licenses</p>

More information

Programming and Operating Manual for SIRIUS Motor Starter
PCS 7 Block Library V7.1 + SP2 see
<http://support.automation.siemens.com/WW/view/en/41856573>.

Getting Started for SIRIUS Motor Starter PCS 7 Block Library
V7.1 + SP2 see
<http://support.automation.siemens.com/WW/view/en/41856486>.

Note:

Programming Manual and GETTING STARTED are valid for
engineering software V7 and engineering software migration
V7-V8.

PROFIBUS

SIMOCODE 3UF Motor Management and Control Devices

SIMOCODE pro

General data

Overview

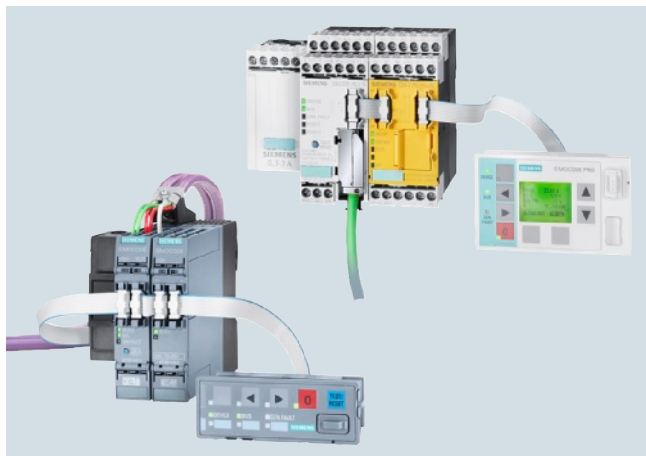

SIMOCODE pro S for efficient entry into motor management and SIMOCODE pro V for maximum functionality

SIMOCODE pro is a flexible, modular motor management system for motors with constant speeds in the low-voltage performance range. It optimizes the connection between I&C and motor feeder, increases plant availability and allows significant savings to be made for installation, commissioning, operation and maintenance of a system.

When SIMOCODE pro is installed in the low-voltage switchboard, it is the intelligent interface between the higher-level automation system and the motor feeder and includes the following:

- Multifunctional, electronic full motor protection, independent of the automation system
- Integrated control functions instead of hardware for the motor control
- Detailed operating, service and diagnostics data
- Open communication through PROFIBUS DP, PROFINET and OPC UA
- Safety relay function for the fail-safe disconnection of motors up to SIL 3 (IEC 61508, IEC 62061) or PL e with Category 4 (EN ISO 13849-1)
- SIMOCODE ES is the software package for SIMOCODE pro parameterization, start-up and diagnostics.

Device series

SIMOCODE pro is structured into several functionally tiered series:

- SIMOCODE pro C, as a compact system for direct-on-line starters and reversing starters or for controlling a motor starter protector
- SIMOCODE pro S, the smart system for direct-on-line, reversing, and wye-delta starters or for controlling a motor starter protector or soft starter. As it can be expanded with a multifunction module, it offers an extensive range of inputs and outputs, precise ground-fault detection via the 3UL23 residual current transformer and temperature measurement.
- SIMOCODE pro V, as a variable system with all control functions and with the possibility of expanding the inputs, outputs and functions of the system at will using expansion modules

Expansion options	SIMOCODE			
	pro C	pro S	pro V ³⁾	
	PROFIBUS	PROFIBUS	PROFIBUS ¹⁾	PROFINET
Operator panels	✓	✓	✓	✓
Operator panels with display	--	--	✓	✓
Current measuring modules	✓	✓	✓	✓
Current/voltage measuring modules	--	--	✓	✓
Decoupling modules	--	--	✓	✓
Expansion modules:				
• Digital modules	--	--	2	2
• Fail-safe digital modules ²⁾	--	--	1	1
• Analog modules	--	--	1	2
• Ground-fault modules	--	--	1	1
• Temperature modules	--	--	1	2
• Multifunction modules	--	1	--	--

✓ Available

-- Not available

¹⁾ When an operator panel with display and/or a decoupling module are used, more restrictions on the number of expansion modules connectable per basic unit must be observed, see page 3/286.

²⁾ The fail-safe digital module can be used instead of one of the two digital modules.

³⁾ Maximum of 5 expansion modules.

Per feeder each system always comprises one basic unit and one separate current measuring module. The two modules are connected together electrically through the system interface with a connection cable and can be mounted mechanically connected as a unit (one behind the other) or separately (side by side). The motor current to be monitored is decisive only for the choice of the current measuring module.

An operator panel for mounting in the control cabinet door is optionally connectable through a second system interface on the basic unit. Both the current measuring module and the operator panel are electrically supplied by the basic unit through the connection cable. More inputs, outputs and functions can be added to the SIMOCODE pro V and SIMOCODE pro S by means of optional expansion modules, thus supplementing the inputs and outputs already existing on the basic unit. With the DM-F Local and DM-F PROFIsafe fail-safe digital modules it is also possible to integrate the fail-safe disconnection of motors in the SIMOCODE pro V motor management system.

All modules are connected by connection cables. The connection cables are available in various lengths. The maximum distance between the modules (e.g. between the basic unit and the current measuring module) must not exceed 2.5 m. The total length of all the connection cables per system interface of the basic unit may be up to 3 m.

Overview (continued)

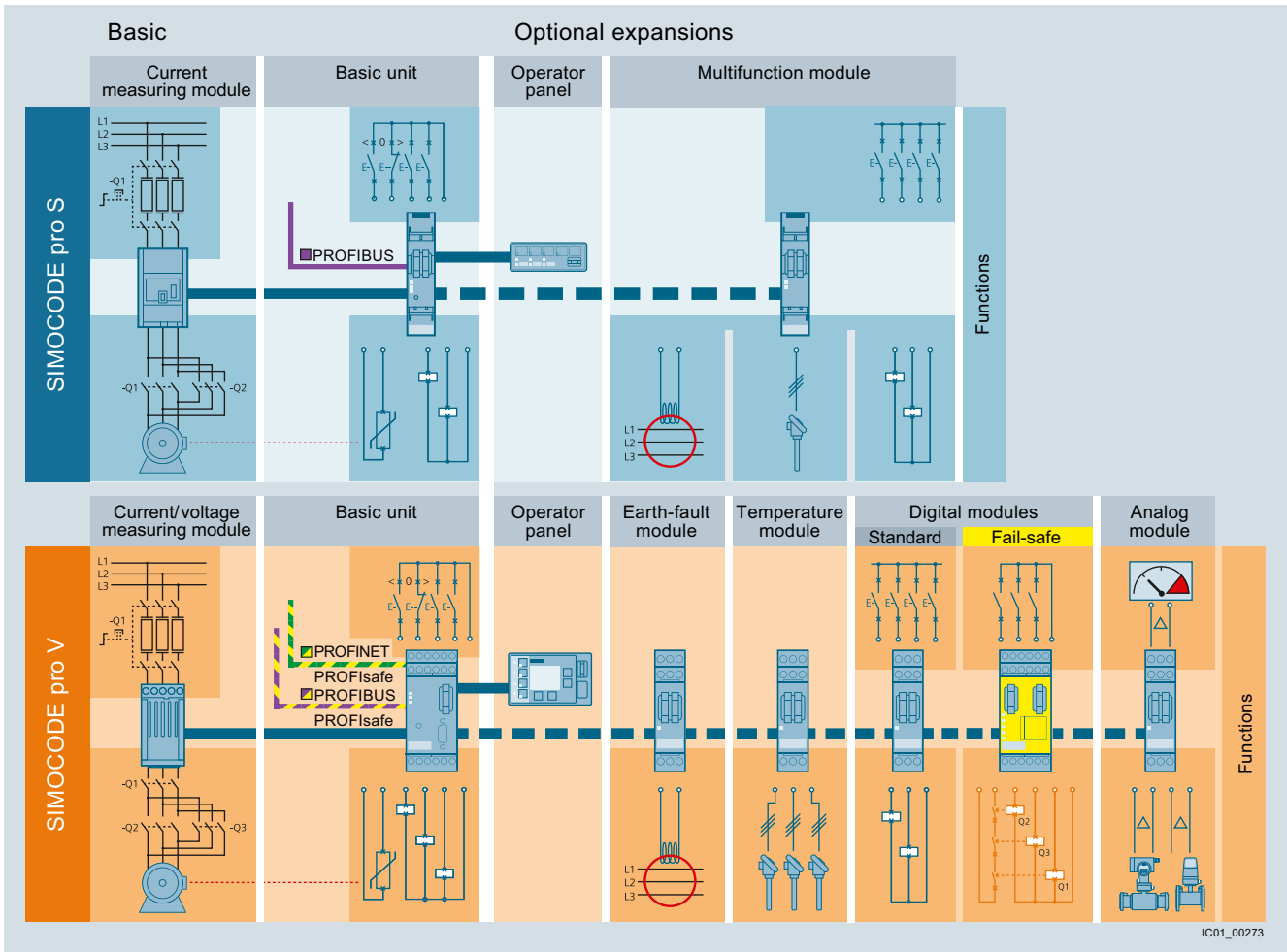

SIMOCODE pro V and SIMOCODE pro S: System structure

Connection methods

Selection tables for the SIMOCODE pro motor management system can be found on the following pages.

 Screw terminals

PROFIBUS

SIMOCODE 3UF Motor Management and Control Devices

SIMOCODE pro

General data

Benefits

General customer benefits

- Integrating the whole motor feeder into the process control by means of PROFIBUS DP, PROFINET or OPC UA significantly reduces the wiring outlay between the motor feeder and PLC.
- Decentralization of the automated processes by means of configurable control and monitoring functions in the feeder saves resources in the automation system and ensures full functionality and protection of the feeder even if the I&C or bus system fails.
- The acquisition and monitoring of operating, service and diagnostics data in the feeder and process control system increases plant availability as well as maintenance and service-friendliness.
- The high degree of modularity allows users to perfectly implement their plant-specific requirements for each motor feeder.
- The SIMOCODE pro system offers functionally graded and space-saving solutions for each customer application.
- The replacement of the control circuit hardware with integrated control functions decreases the number of hardware components and wiring required and in this way limits stock keeping costs and potential wiring errors.
- The use of electronic full motor protection permits better utilization of the motors and ensures long-term stability of the tripping characteristic and reliable tripping even after years of service.

Multifunctional, electronic full motor protection for rated motor currents up to 820 A

SIMOCODE pro provides comprehensive protection of the motor feeder by means of a combination of delayable, multi-level protection and monitoring functions:

- Inverse-time delayed electronic overload protection (CLASS 5 to 40)
- Thermistor motor protection
- Phase failure/unbalance protection
- Stall protection
- Monitoring of adjustable limit values for the motor current
- Voltage and power monitoring
- Monitoring of the power factor (motor idling/load shedding)
- Ground-fault monitoring
- Temperature monitoring, e.g. over PT100/PT1 000
- Monitoring of operating hours, downtime and number of starts etc.

Recording of measuring curves

SIMOCODE pro can record measuring curves and therefore is able, for example, to present the progression of motor current during motor start-up.

Flexible motor control implemented with integrated control functions (instead of comprehensive hardware interlocks)

Many predefined motor control functions have already been integrated into SIMOCODE pro, including all necessary logic operations and interlocks:

- Overload relays
- Direct-on-line and reversing starters
- Wye/delta starters (also with direction reversal)
- Two speeds, motors with separate windings (pole-changing starters); also with direction reversal
- Two speeds, motors with separate Dahlander windings (also with direction reversal)
- Positioner actuation
- Solenoid valve actuation
- Control of a motor starter protector
- Soft starter actuation (also with direction reversal)

These control functions are predefined in SIMOCODE pro and can be freely assigned to the inputs and outputs of the device (including PROFIBUS/PROFINET).

These predefined control functions can also be flexibly adapted to each customized configuration of a motor feeder by means of freely configurable logic modules (truth tables, counters, timers, edge evaluation, etc.) and with the help of standard functions (power failure monitoring, emergency start, external faults, etc.), without additional auxiliary relays being necessary in the control circuit.

SIMOCODE pro makes a lot of additional hardware and wiring in the control circuit unnecessary which results in a high level of standardization of the motor feeder in terms of its design and circuit diagrams.

Benefits (continued)

Detailed operating, service and diagnostics data

SIMOCODE pro makes different operating, service and diagnostics data available and helps to detect potential faults in time and to prevent them by means of preventative measures. In the event of a malfunction, a fault can be diagnosed, localized and rectified very quickly – there are no or very short downtimes.

Operating data

- Motor switching state derived from the current flow in the main circuit
- All phase currents
- All phase voltages and phase-to-phase voltages
- Active power, apparent power and power factor
- Phase unbalance and phase sequence
- Ground-fault current
- Time to trip
- Motor temperature
- Remaining cooling time etc.

Service data

- Motor operating hours
- Motor stop times
- Number of motor starts
- Number of overload trips
- Interval for compulsory testing of the enabling circuits
- Energy consumed
- Internal comments stored in the device etc.

Diagnostics data

- Numerous detailed early warning and fault messages
- Internal device fault logging with time stamp
- Time stamping of freely selectable status, alarm or fault messages etc.

Easy operation and diagnostics

Operator panel

The operator panel is used to control the motor feeder and can replace all conventional pushbuttons and indicator lights to save space. It makes SIMOCODE pro or the feeder directly operable in the control cabinet. It features all the status LEDs available on the basic unit and externalizes the system interface for simple parameterization or diagnosis on a PC/PG.

Operator panel with display

As an alternative to the 3UF720 standard operator panel for SIMOCODE pro V, there is also an operator panel with display: the 3UF7 21 is thus able in addition to indicate measured values, operating and diagnostics data or status information of the motor feeder at the control cabinet. The pushbuttons of the operator panel can be used to control the motor. Also, when SIMOCODE pro V PROFINET is used it is possible to set parameters such as rated motor current, limit values, etc. directly via the operator panel with display.

Communications

SIMOCODE pro has either an integrated PROFIBUS DP interface (SUB-D or terminal connection) or a PROFINET interface (2 x RJ45).

Fail-safe disconnection through PROFIBUS or PROFINET with the PROFIsafe profile is also possible in conjunction with a fail-safe controller (F-CPU) and the DM-F PROFIsafe fail-safe digital module.

SIMOCODE pro for PROFIBUS

SIMOCODE pro for PROFIBUS supports for example:

- Cyclic services (DPV0) and acyclic services (DPV1)
- Extensive diagnostics and hardware interrupts
- Time stamp with high timing precision (SIMATIC S7) for SIMOCODE pro V
- DPV1 communication after the Y-Link

SIMOCODE pro for PROFINET

SIMOCODE pro for PROFINET supports for example:

- Line and ring bus topology thanks to an integrated switch
- Media redundancy via MRP protocol
- Operating, service and diagnostics data via standard web browser
- OPC UA server for open communication with visualization and control systems
- NTP-synchronized time
- Interval function and measured values for energy management via PROFenergy
- Module exchange without PC memory module through proximity detection
- Extensive diagnostics and maintenance alarms

Notes on safety

For connection of an internal system to an external system, suitable protective measures must be taken to ensure safe operation of the plant (including IT security, e. g. network segmentation).

More information see www.siemens.com/industrialsecurity.

SIMOCODE pro motor management and control devices with communication function see page 3/288 onwards.

Accessories see page 3/293 onwards.

More information see Catalog IC 10, Chapter 14 "Parameterization, Configuration and Visualization with SIRIUS", Industry Mall or Interactive Catalog CA 01.

Autonomous operation

An essential feature of SIMOCODE pro is the autonomous execution of all protection and control functions, even when communication to the I&C system is interrupted. This means that even in the event of bus system or automation system failure, full functionality of the feeder is ensured or a specific behavior can be parameterized in case of such a fault, e.g. targeted shutdown of the feeder or execution of particular parameterized control mechanisms (such as reversal of the direction of rotation).

PROFIBUS

SIMOCODE 3UF Motor Management and Control Devices

SIMOCODE pro

General data

Application

SIMOCODE pro is often used for automated processes where plant downtimes are very expensive (e.g. steel or cement industry) and where it is important to prevent plant downtimes through detailed operating, service and diagnostics data or to localize the fault very quickly in the event of a fault.

SIMOCODE pro is modular and space-saving and suited especially for operation in motor control centers (MCCs) in the process industry and for power plant technology.

Applications

Protection and control of motors in hazardous areas for types of protection EEx e/d according to ATEX guideline 94/9/EC

- With heavy starting (paper, cement, metal and water industries)
- In high-availability plants (chemical, oil, raw material processing industries, power plants)

Safety technology for SIMOCODE pro

The safe disconnection of motors in the process industry is becoming increasingly important as the result of new and revised standards and requirements in the safety engineering field.

With the DM-F Local and DM-F PROFIsafe fail-safe expansion modules it is easy to integrate functions for fail-safe disconnection into the SIMOCODE pro V motor management system while retaining service-proven concepts. The strict separation of safety functions and operational functions proves particularly advantageous for planning, configuring and construction. Seamless integration in the motor management system leads to greater transparency for diagnostics and during operation of the system.

Suitable components for this purpose are the DM-F Local and DM-F PROFIsafe fail-safe expansion modules, depending on the requirements:

- The DM-F Local fail-safe digital module for when direct assignment between a fail-safe hardware shutdown signal and a motor feeder is required, or
- The DM-F PROFIsafe fail-safe digital module for when a fail-safe controller (F-CPU) creates the signal for the disconnection and transmits it in a fail-safe manner through PROFIBUS/PROFIsafe or PROFINET/PROFIsafe to the motor management system

More information

Configuration instructions when using an operator panel with display and/or a decoupling module with SIMOCODE pro V with PROFIBUS

If you want to use a decoupling module or an operator panel with display in the SIMOCODE pro V system with PROFIBUS, then the following configuration instructions concerning the type and number of connectable expansion modules must be observed.

The following tables show the maximum possible configuration of the expansion modules for the various combinations.

The DM-F Local and DM-F PROFIsafe fail-safe expansion modules behave in this connection like digital modules for standard applications.

Use of an operator panel with display

Digital module 1	Digital module 2	Analog modules	Temperature modules	Ground-fault modules
------------------	------------------	----------------	---------------------	----------------------

Only operator panel with display for SIMOCODE pro V (24 V DC or 110 ... 240 V AC/DC)

Max. 4 expansion modules can be used

Operator panel with display and current/voltage measurement with SIMOCODE pro V (110 ... 240 V AC/DC)

Max. 3 expansion modules can be used or:

--	--	✓	✓	--
----	----	---	---	----

✓ Available

-- Not available

Use of a decoupling module

(voltage measurement in insulated networks)

Digital module 1	Digital module 2	Analog modules	Temperature modules	Ground-fault modules
SIMOCODE pro V (24 V DC)				
✓ ¹⁾	✓ ¹⁾	✓	✓	✓
SIMOCODE pro V (110 ... 240 V AC/DC)				
✓	✓	--	✓	✓
✓ ¹⁾	✓ ¹⁾	✓	✓	--
✓	--	✓	✓	--
✓	--	✓	--	✓

✓ Available

-- Not available

¹⁾ No bistable relay outputs and no more than 5 of 7 relay outputs active simultaneously (> 3 s).

Use of a decoupling module

(voltage measurement in insulated networks) in combination with an operator panel with display

Digital module 1	Digital module 2	Analog modules	Temperature modules	Ground-fault modules
SIMOCODE pro V (24 V DC)				
✓	--	✓	✓	✓
✓	✓	--	✓	✓
SIMOCODE pro V (110 ... 240 V AC/DC)				
✓ ²⁾	--	✓	✓	✓
✓	✓	--	--	--
✓ ¹⁾	✓ ¹⁾	✓ ³⁾	--	--
✓	--	--	✓	✓

✓ Available

-- Not available

¹⁾ No bistable relay outputs and no more than 5 of 7 relay outputs active simultaneously (> 3 s).

²⁾ No bistable relay outputs and no more than 3 of 5 relay outputs active simultaneously (> 3 s).

³⁾ Analog module output is not used.

More information (continued)**Protective separation**

All circuits in SIMOCODE pro are safely isolated from each other in accordance with IEC 60947-1. That is, they are designed with double creepages and clearances. In the event of a fault, therefore, no parasitic voltages can be formed in neighboring circuits. The instructions of Test log No. 2668 must be complied with.

Types of protection EEx e and EEx d

The overload protection and the thermistor motor protection of the SIMOCODE pro system comply with the requirements for overload protection of explosion-proof motors to the type of protection:

- EEx d "flameproof enclosure" e.g. according to IEC 60079-1
- EEx e "increased safety" e.g. according to IEC 60079-7

When using SIMOCODE pro devices with a 24 V DC control voltage, electrical separation must be ensured using a battery or a safety transformer according to IEC 61558-2-6. EC type test certificate: BVS 06 ATEX F 001
 Test log: BVS PP 05.2029 EG.

Selection data for type-tested assemblies/load feeders

For configuration tables according to type of coordination "1" or "2", see

- Manual "Configuring SIRIUS",
 Article No.: 3ZX1012-ORA21-0AB0,
<http://support.automation.siemens.com/WW/view/en/40625241>
- Manual "Configuring SIRIUS Innovations",
 Article No.: 3ZX1012-ORA21-1AB0,
<http://support.automation.siemens.com/WW/view/en/39714188>
- SIMOCODE pro PROFIBUS System Manual,
 Article No.: 3UF7970-0AA01-0,
<http://support.automation.siemens.com/WW/view/en/20017780>
- SIMOCODE pro PROFINET System Manual,
 Article No.: 3ZX1012-OUF70-1AB1,
<http://support.automation.siemens.com/WW/view/en/61896631>

System manual

The SIMOCODE pro system manual describes the motor management system and its functions in detail. It provides information on configuration, start-up, servicing and maintenance. A typical example of a reversing starter application is used to teach the user quickly and practically how to use the system. In addition to help on how to identify and rectify faults in the event of a malfunction, the manual also contains special information for servicing and maintenance. For selection of equipment and for planning, it is recommended to consult the system manual.

A detailed description of the DM-F Local and DM-F PROFIsafe fail-safe expansion modules is provided in the system manual "SIMOCODE pro Safety Fail-Safe Digital Modules", which can be downloaded from the Internet.

Internet

More information see www.siemens.com/simocode.





PROFIBUS

SIMOCODE 3UF Motor Management and Control Devices

SIMOCODE pro







Basic units

Selection and ordering data

Version		Screw terminals Article No. 
SIMOCODE pro C  3UF7000-1A.00-0	SIMOCODE pro C PROFIBUS DP interface, 12 Mbit/s, RS 485 4 I/3 O freely assignable, input for thermistor connection, monostable relay outputs Rated control supply voltage U_s : <ul style="list-style-type: none"> • 24 V DC • 110 ... 240 V AC/DC 	3UF7000-1AB00-0 3UF7000-1AU00-0
 3UF7020-1A.01-0	SIMOCODE pro S PROFIBUS DP interface, 1.5 Mbit/s, RS 485 4 I/2 O freely assignable, input for thermistor connection, monostable relay outputs, can be expanded by a multifunction module Rated control supply voltage U_s : <ul style="list-style-type: none"> • 24 V DC • 110 ... 240 V AC/DC 	3UF7020-1AB01-0 3UF7020-1AU01-0
 3UF7010-1A.00-0	SIMOCODE pro V PROFIBUS DP interface, 12 Mbit/s, RS 485 4 I/3 O freely assignable, input for thermistor connection, monostable relay outputs, can be expanded by expansion modules Rated control supply voltage U_s : <ul style="list-style-type: none"> • 24 V DC • 110 ... 240 V AC/DC 	3UF7010-1AB00-0 3UF7010-1AU00-0
 3UF7011-1A.00-0	SIMOCODE pro V PROFINET¹⁾ ETHERNET/PROFINET IO, OPC UA server and web server, 100 Mbit/s, 2 x connection to bus through RJ45, 4 I/3 O freely assignable, input for thermistor connection, monostable relay outputs, can be expanded by expansion modules Rated control supply voltage U_s : <ul style="list-style-type: none"> • 24 V DC • 110 ... 240 V AC/DC 	3UF7011-1AB00-0 3UF7011-1AU00-0

¹⁾ When using an operator panel with display, the product version must be E07 or higher (from 08/2012).

Selection and ordering data (continued)

Version	Current setting A	Width mm	Screw terminals Article No.	
SIMOCODE pro (continued)				
Current measuring modules				
 3UF7100-1AA00-0	• Straight-through transformers	0.3 ... 3	45	3UF7100-1AA00-0 3UF7101-1AA00-0 3UF7102-1AA00-0 3UF7103-1AA00-0 3UF7103-1BA00-0 3UF7104-1BA00-0
		2.4 ... 25	45	
		10 ... 100	55	
		20 ... 200	120	
	• Busbar connections	20 ... 200	120	
		63 ... 630	145	
Current/voltage measuring modules for SIMOCODE pro V				
Voltage measuring up to 690 V if required in connection with a decoupling module				
 3UF7110-1AA00-0	• Straight-through transformers	0.3 ... 3	45	3UF7110-1AA00-0 3UF7111-1AA00-0 3UF7112-1AA00-0 3UF7113-1AA00-0 3UF7113-1BA00-0 3UF7114-1BA00-0
		2.4 ... 25	45	
		10 ... 100	55	
		20 ... 200	120	
	• Busbar connections	20 ... 200	120	
		63 ... 630	145	
Decoupling modules				
 3UF7150-1AA00-0	For connecting upstream from a current/voltage measuring module on the system interface when using voltage measurement in insulated, high-resistance or asymmetrically grounded systems and in single-phase systems			3UF7150-1AA00-0
Operator panels				
 3UF7200-1AA00-0	Installation in control cabinet door or front plate, for plugging into all SIMOCODE pro basic units, 10 LEDs for status indication and user-assignable buttons for controlling the motor			3UF7200-1AA00-0 3UF7200-1AA01-0
	• Light gray • Titanium gray			
 3UF7200-1AA01-0				
Operator panel with display for SIMOCODE pro V				
 3UF7210-1AA00-0	Installation in control cabinet door or front plate, for plugging into SIMOCODE pro V and SIMOCODE pro V PN, 7 LEDs for status indication and user-assignable buttons for controlling the motor, multilingual display, e.g. for indication of measured values, status information or fault messages			3UF7210-1AA00-0

Notes:

System manual "SIMOCODE pro PROFIBUS" see <http://support.automation.siemens.com/WW/view/en/20017780>.

System manual "SIMOCODE pro V PROFINET" see <http://support.automation.siemens.com/WW/view/en/61896631>.

SIMOCODE pro V basic unit in a hardened version via SIPLUS extreme upon request.





PROFIBUS

SIMOCODE 3UF Motor Management and Control Devices

SIMOCODE pro

Expansion modules

Selection and ordering data (continued)

Version		Screw terminals Article No.
<i>Expansion modules for SIMOCODE pro V</i>		
<p>With SIMOCODE pro V, it is possible to expand the type and number of inputs and outputs in steps. Each expansion module has two system interfaces on the front. Through the one system interface the expansion module is connected to the system interface of the SIMOCODE pro V using a connection cable; through the second system interface, further expansion modules or the operator panel can be connected. The power supply for the expansion modules is provided by the connection cable through the basic unit.</p> <p><u>Note:</u> Please order connection cable separately, see page 3/293.</p>		
Digital modules		
<p>Up to two digital modules can be used to add additional binary inputs and relay outputs to the basic unit. The input circuits of the digital modules are supplied from an external power supply.</p>		
<p>4 binary inputs and 2 relay outputs, up to 2 digital modules can be connected</p>		
 <p>3UF7300-1AU00-0</p>	<p><i>Relay outputs</i></p> <p>Monostable</p>	<p>3UF7300-1AB00-0</p>
	<p><i>Input voltage</i></p> <p>24 V DC</p>	<p>3UF7300-1AU00-0</p>
	<p>110 ... 240 V AC/DC</p>	<p>3UF7310-1AB00-0</p>
	<p>Bistable</p> <p>24 V DC</p>	<p>3UF7310-1AU00-0</p>
	<p>110 ... 240 V AC/DC</p>	<p>3UF7310-1AU00-0</p>
Analog modules		
<p>Basic unit can be optionally expanded with analog inputs and outputs (0/4 ... 20 mA) by means of the analog module.</p>		
<p>2 inputs (passive) for input and 1 output for output of 0/4 ... 20 mA signals, max. 1 analog module can be connected per pro V basic unit and max. 2 analog modules per pro V PN basic unit</p>		
 <p>3UF7400-1AA00-0</p>	<p>3UF7400-1AA00-0</p>	
Ground-fault modules¹⁾		
<p>Ground-fault monitoring using 3UL23 residual-current transformers and ground-fault modules is used in cases where precise detection of the ground-fault current is required or power systems with high impedance are grounded.</p>		
<p>With the ground-fault module, it is possible to determine the precise fault current as a measured value, and to define freely selectable warning and trip limits in a wide range from 30 mA ... 40 A.</p>		
<p>1 input for connecting a 3UL23 residual-current transformer, up to 1 ground-fault module can be connected</p>		
 <p>3UF7510-1AA00-0</p>	<p>3UF7510-1AA00-0</p>	
Temperature modules		
<p>Independently of the thermistor motor protection of the basic units, up to 3 analog temperature sensors can be evaluated using a temperature module.</p>		
<p>Sensor types: PT100/PT1 000, KTY83/KTY84 or NTC</p>		
<p>3 inputs for connecting up to 3 analog temperature sensors, up to 1 temperature module can be connected per pro V basic unit and max. 2 temperature modules per pro V PN basic unit</p>		
 <p>3UF7700-1AA00-0</p>	<p>3UF7700-1AA00-0</p>	

¹⁾ Possible with pro V basic unit from product version E10 or pro V PN basic unit from product version E04.

Selection and ordering data (continued)

Version	Screw terminals Article No.	+
Expansion modules for SIMOCODE pro S		
<p>With SIMOCODE pro S, it is possible to expand the type and number of inputs and outputs. The expansion module has two system interfaces on the front. Through the one system interface the expansion module is connected to the system interface of the SIMOCODE pro S using a connection cable; through the second system interface, the operator panel can be connected. The power supply for the expansion module is provided by the connection cable through the basic unit.</p> <p><u>Note:</u> Please order connection cable separately, see page 3/293.</p>		
<p>Multifunction modules</p> <p>The multifunction module is the expansion module of the SIMOCODE pro S device series with the following functions:</p> <ul style="list-style-type: none"> • Digital module function with four digital inputs and two monostable relay outputs • Ground-fault module function with an input for the connection of a 3UL23 residual-current transformer with freely selectable warning and trip limits in a wide zone of 30 mA ... 40 A • Temperature module function with an input for connecting an analog temperature sensor PT100, PT1 000, KTY83, KTY84, or NTC <p>Max. 1 multifunction module can be connected per pro S basic unit</p> <p>Input voltage of the digital inputs:</p> <ul style="list-style-type: none"> • 24 V DC • 110 ... 240 V AC/DC 		
 <p>3UF7600-1AU01-0</p>	<p>3UF7600-1AB01-0 3UF7600-1AU01-0</p>	



PROFIBUS

SIMOCODE 3UF Motor Management and Control Devices

SIMOCODE pro

Fail-safe expansion modules

Selection and ordering data (continued)

Version	Screw terminals Article No.
<i>Fail-safe expansion modules for SIMOCODE pro V</i>	
<p>Thanks to the fail-safe expansion modules, SIMOCODE pro V can be expanded with the function of a safety relay for the fail-safe disconnection of motors. A maximum of 1 fail-safe digital module can be connected; it can be used instead of a digital module.</p> <p>The fail-safe expansion modules are equipped likewise with two system interfaces at the front for making the connection to other system components. Unlike other expansion modules, power is supplied to the modules through a separate terminal connection.</p> <p><u>Note:</u> Please order connection cable separately, see page 3/293.</p>	
 <p>3UF7320-1AB00-0</p> <p>DM-F Local fail-safe digital modules¹⁾</p> <p>For fail-safe disconnection using a hardware signal</p> <p>2 relay enabling circuits, joint switching; 2 relay outputs, common potential disconnected fail-safe; inputs for sensor circuit, start signal, cascading and feedback circuit, safety function adjustable using DIP switches</p> <p>Rated control supply voltage U_S:</p> <ul style="list-style-type: none"> • 24 V DC • 110 ... 240 V AC/DC 	<p>3UF7320-1AB00-0 3UF7320-1AU00-0</p>
 <p>3UF7330-1AB00-0</p> <p>DM-F PROFIsafe fail-safe digital modules¹⁾</p> <p>For fail-safe disconnection using PROFIBUS/PROFIsafe or PROFINET/PROFIsafe</p> <p>2 relay enabling circuits, joint switching; 2 relay outputs, common potential disconnected fail-safe; 1 input for feedback circuit; 3 binary standard inputs</p> <p>Rated control supply voltage U_S:</p> <ul style="list-style-type: none"> • 24 V DC • 110 ... 240 V AC/DC 	<p>3UF7330-1AB00-0 3UF7330-1AU00-0</p>









¹⁾ Possible with SIMOCODE pro V basic unit, product version E07 and higher (from 05/2011) or SIMOCODE pro V PN basic unit.

Note:

System manual "SIMOCODE pro Safety Fail-Safe Digital Modules" see

<http://support.automation.siemens.com/WW/view/en/50564852>.

Selection and ordering data (continued)

Version	Article No.																								
Connection cables (essential accessory)																									
 <p>3UF7932-0AA00-0</p> <p>Connection cables In different lengths for connecting basic unit, current measuring module, current/voltage measuring module, operator panel or expansion modules or decoupling module</p> <table border="1"> <thead> <tr> <th>Version</th> <th>Length</th> <th>Article No.</th> </tr> </thead> <tbody> <tr> <td>Flat</td> <td>0.025 m</td> <td>3UF7930-0AA00-0</td> </tr> <tr> <td>Flat</td> <td>0.1 m</td> <td>3UF7931-0AA00-0</td> </tr> <tr> <td>Flat</td> <td>0.3 m</td> <td>3UF7935-0AA00-0</td> </tr> <tr> <td>Flat</td> <td>0.5 m</td> <td>3UF7932-0AA00-0</td> </tr> <tr> <td>Round</td> <td>0.5 m</td> <td>3UF7932-0BA00-0</td> </tr> <tr> <td>Round</td> <td>1.0 m</td> <td>3UF7937-0BA00-0</td> </tr> <tr> <td>Round</td> <td>2.5 m</td> <td>3UF7933-0BA00-0</td> </tr> </tbody> </table>	Version	Length	Article No.	Flat	0.025 m	3UF7930-0AA00-0	Flat	0.1 m	3UF7931-0AA00-0	Flat	0.3 m	3UF7935-0AA00-0	Flat	0.5 m	3UF7932-0AA00-0	Round	0.5 m	3UF7932-0BA00-0	Round	1.0 m	3UF7937-0BA00-0	Round	2.5 m	3UF7933-0BA00-0	
Version	Length	Article No.																							
Flat	0.025 m	3UF7930-0AA00-0																							
Flat	0.1 m	3UF7931-0AA00-0																							
Flat	0.3 m	3UF7935-0AA00-0																							
Flat	0.5 m	3UF7932-0AA00-0																							
Round	0.5 m	3UF7932-0BA00-0																							
Round	1.0 m	3UF7937-0BA00-0																							
Round	2.5 m	3UF7933-0BA00-0																							
PC cables and adapters																									
 <p>3UF7940-0AA00-0</p> <p>RS 232 PC cables For connecting to the serial interface of a PC/PG, for communication with SIMOCODE pro through the system interface</p>	3UF7940-0AA00-0																								
 <p>3UF7941-0AA00-0</p> <p>USB PC cables For connecting to the USB interface of a PC/PG, for communication with SIMOCODE pro through the system interface</p>	3UF7941-0AA00-0																								
 <p>3UF7941-0AA00-0</p> <p>USB/serial adapters To connect an RS 232 PC cable to the USB interface of a PC, recommended for use in conjunction with SIMOCODE pro 3UF7</p>	3UF7946-0AA00-0																								
Memory modules																									
 <p>3UF7900-0AA00-0</p> <p>This enables transmission to a new system, e.g. when a device is replaced, without the need for additional aids or detailed knowledge of the device.</p> <p>Memory module for SIMOCODE pro C, SIMOCODE pro S and SIMOCODE pro V For saving the complete parameterization of a SIMOCODE pro C, SIMOCODE pro S or SIMOCODE pro V system</p>	3UF7900-0AA00-0																								
 <p>3UF7901-0AA00-0</p> <p>Memory module for SIMOCODE pro V PROFINET For saving the complete parameterization of a SIMOCODE pro V PROFINET system</p>	3UF7901-0AA00-0																								
Interface covers																									
 <p>3UF7950-0AA00-0</p> <p>Interface covers For system interface</p> <ul style="list-style-type: none"> • Light gray • Titanium gray 	3UF7950-0AA00-0 3RA6936-0B																								
Addressing plugs																									
 <p>3UF7910-0AA00-0</p> <p>Addressing plugs For assigning the PROFIBUS address without using a PC/PG to SIMOCODE pro through the system interface</p>	3UF7910-0AA00-0																								







PROFIBUS

SIMOCODE 3UF Motor Management and Control Devices

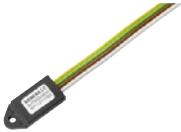
SIMOCODE pro





Accessories

Selection and ordering data (continued)

Version	Article No.								
Accessories for motor control center									
<p>With the draw-out technology often used in motor control centers it is possible to integrate a SIMOCODE pro initialization module in the switchboard on a permanent basis. Feeder-related parameter and address data can then be permanently assigned to this feeder.</p> <p>Initialization module¹⁾ For automatic parameterization of SIMOCODE pro S, SIMOCODE pro V and SIMOCODE pro V PROFINET, for fixed-mounted installation in switchboards</p>  <p>3UF7902-0AA00-0</p>	3UF7902-0AA00-0								
<p>Y connection cable¹⁾ For use in conjunction with the initialization module; connects the basic unit, current measuring module or current/voltage measuring module, and initialization module</p> <table border="1"> <thead> <tr> <th>System interface length</th> <th>Open cable end</th> </tr> </thead> <tbody> <tr> <td>0.1 m</td> <td>1.0 m</td> </tr> <tr> <td>0.5 m</td> <td>1.0 m</td> </tr> <tr> <td>1.0 m</td> <td>1.0 m</td> </tr> </tbody> </table>	System interface length	Open cable end	0.1 m	1.0 m	0.5 m	1.0 m	1.0 m	1.0 m	<p>3UF7931-0CA00-0</p> <p>3UF7932-0CA00-0</p> <p>3UF7937-0CA00-0</p>
System interface length	Open cable end								
0.1 m	1.0 m								
0.5 m	1.0 m								
1.0 m	1.0 m								
Bus connection terminals									
 <p>3UF7960-0AA00-0</p> <p>Bus connection terminal For shield support and strain relief of the PROFIBUS cable on a SIMOCODE pro S</p>	3UF7960-0AA00-0								
Door adapters									
 <p>3UF7920-0AA00-0</p> <p>Door adapters For external connection of the system interface, e.g. outside a control cabinet</p>	3UF7920-0AA00-0								
Adapters for operator panel									
 <p>3UF7922-0AA00-0</p> <p>Adapters for operator panel The adapter enables the smaller 3UF7200 operator panel from SIMOCODE pro to be used in a front panel cutout in which previously, e.g. after a change of system, a larger 3UF52 operator panel from SIMOCODE-DP had been used, degree of protection IP54</p>	3UF7922-0AA00-0								
Labeling strips									
 <p>3UF7925-0AA02-0</p> <p>Labeling strips</p> <ul style="list-style-type: none"> • For pushbuttons of the 3UF720 operator panel • For pushbuttons of the 3UF721 operator panel with display • For LEDs of the 3UF720 operator panel 	<p>3UF7925-0AA00-0</p> <p>3UF7925-0AA01-0</p> <p>3UF7925-0AA02-0</p>								
Push-in lugs									
 <p>3RV2928-0B</p> <p>Push-in lugs for screw fixing e.g. on mounting plate, 2 units required per device</p> <ul style="list-style-type: none"> • Can be used for 3UF71.0, 3UF71.1 and 3UF71.2 • Can be used for 3UF700, 3UF701, 3UF73, 3UF74, 3UF75 and 3UF77 • Can be used for 3UF7020, 3UF7600 	<p>3RV2928-0B</p> <p>3RP1903</p> <p>3ZY1311-0AA00</p>								

¹⁾ Possible with pro V basic unit, product version E09 (11/2012) and higher, pro S basic unit or pro V PN basic unit.

Selection and ordering data (continued)

	Version	Article No.
Terminal covers		
 3RT1956-4EA1	Covers for cable lugs and busbar connections <ul style="list-style-type: none"> Length 100 mm, can be used for 3UF71.3-1BA00-0 Length 120 mm, can be used for 3UF71.4-1BA00-0 	3RT1956-4EA1 3RT1966-4EA1
	Covers for box terminals <ul style="list-style-type: none"> Length 25 mm, can be used for 3UF71.3-1BA00-0 Length 30 mm, can be used for 3UF71.4-1BA00-0 	3RT1956-4EA2 3RT1966-4EA2
 3RT1956-4EA2	Covers for screw terminals Between contactor and current measuring module or current/voltage measuring module for direct mounting <ul style="list-style-type: none"> Can be used for 3UF71.3-1BA00-0 Can be used for 3UF71.4-1BA00-0 	3RT1956-4EA3 3RT1966-4EA3
Box terminal blocks		
 3RT195-4G	Box terminal blocks For round and ribbon cables <ul style="list-style-type: none"> Up to 70 mm², can be used for 3UF71.3-1BA00-0 Up to 120 mm², can be used for 3UF71.3-1BA00-0 Up to 240 mm², can be used for 3UF71.4-1BA00-0 	3RT1955-4G 3RT1956-4G 3RT1966-4G
Bus termination modules		
 3UF1900-1KA00	Bus termination modules With separate control supply voltage for bus termination following the last unit on the bus line Supply voltage: <ul style="list-style-type: none"> 115/230 V AC 24 V DC 	3UF1900-1KA00 3UF1900-1KB00

PROFIBUS

SIMOCODE 3UF Motor Management and Control Devices

SIMOCODE pro

Accessories

Selection and ordering data (continued)

Parameterization and service software for SIMOCODE pro 3UF7

- Delivered without PC cable

Version	Article No.
SIMOCODE ES (TIA Portal) V12 basic	
Floating license for one user Engineering software, software and documentation on DVD, 6 languages (German/English/French/Italian/Spanish/Chinese), for all SIMOCODE pro with PROFIBUS, online functions through system interface) <ul style="list-style-type: none"> License key on USB stick, Class A License key download, Class A 	3ZS1322-4CC10-0YA5 3ZS1322-4CE10-0YB5
SIMOCODE ES (TIA Portal) V12 standard	
Floating license for one user Engineering software, software and documentation on DVD, 6 languages (German/English/French/Italian/Spanish/Chinese), for all SIMOCODE pro with PROFIBUS, online functions through system interface parameterizing with integrated graphics editor (CFC-based) <ul style="list-style-type: none"> License key on USB stick, Class A License key download, Class A 	3ZS1322-5CC10-0YA5 3ZS1322-5CE10-0YB5
Upgrade for SIMOCODE ES 2007 Floating license for one user, engineering software, software and documentation on DVD, license key on USB stick, Class A, 6 languages (German/English/French/Italian/Spanish/Chinese), combo license for parallel use of SIMOCODE ES 2007 and SIMOCODE ES V12, for all SIMOCODE pro with PROFIBUS,online functions through the system interface, parameterizing with integrated graphics editor (CFC-based)	3ZS1322-5CC10-0YE5
Powerpack for SIMOCODE ES V12 Basic Floating license for one user, engineering software, license key on USB stick, Class A, 6 languages (German/English/French/Italian/Spanish/Chinese), for all SIMOCODE pro with PROFIBUS,online functions through the system interface, parameterizing with integrated graphics editor (CFC-based)	3ZS1322-5CC10-0YD5
Software Update Service For 1 year with automatic extension, assuming the current software version is in use, engineering software, software and documentation on DVD, online functions through the system interface, parameterizing with integrated graphics editor (CFC-based)	3ZS1322-5CC10-0YL5
SIMOCODE ES (TIA Portal) V12 Premium	
Floating license for one user Engineering software, software and documentation on DVD, 6 languages (German/English/French/Italian/Spanish/Chinese), for all SIMOCODE pro with PROFIBUS, online functions through the system interface and PROFIBUS, parameterizing with integrated graphics editor (CFC-based) <ul style="list-style-type: none"> License key on USB stick, Class A License key download, Class A 	3ZS1322-6CC10-0YA5 3ZS1322-6CE10-0YB5
Upgrade for SIMOCODE ES 2007 Floating license for one user, engineering software, software and documentation on DVD, license key on USB stick, Class A, 6 languages (German/English/French/Italian/Spanish/Chinese), combo license for parallel use of SIMOCODE ES 2007 and SIMOCODE ES V12, for all SIMOCODE pro with PROFIBUS, online functions through the system interface and PROFIBUS, parameterizing with integrated graphics editor (CFC-based)	3ZS1322-6CC10-0YE5
Powerpack for SIMOCODE ES V12 Standard Floating license for one user, engineering software, license key on USB stick, Class A, 6 languages (German/English/French/Italian/Spanish/Chinese), for all SIMOCODE pro with PROFIBUS, online functions through the system interface and PROFIBUS, parameterizing with integrated graphics editor (CFC-based)	3ZS1322-6CC10-0YD5
Software Update Service For 1 year with automatic extension, assuming the current software version is in use, engineering software, software and documentation on DVD, online functions through the system interface and PROFIBUS, parameterizing with integrated graphics editor (CFC-based)	3ZS1322-6CC10-0YL5

Notes:

Please order PC cable separately, see page 3/293.

More information see Catalog IC 10, Chapter 14
 "Parameterization, Configuration and Visualization with SIRIUS",
 Industry Mall or Interactive Catalog CA 01.

Selection and ordering data (continued)

Version	Article No.
SIMOCODE ES 2007 Basic	
 <p>Floating license for one user Engineering software, software and documentation on CD, 3 languages (German/English/French), communication through system interface</p> <ul style="list-style-type: none"> • License key on USB stick, Class A • License key download, Class A 	<p>3ZS1312-4CC10-0YA5 3ZS1312-4CE10-0YB5</p>
SIMOCODE ES 2007 Standard	
<p>Floating license for one user Engineering software, software and documentation on CD, 3 languages (German/English/French), communication through system interface, integrated graphics editor</p> <ul style="list-style-type: none"> • License key on USB stick, Class A • License key download, Class A 	<p>3ZS1312-5CC10-0YA5 3ZS1312-5CE10-0YB5</p>
<p>Upgrade for SIMOCODE ES 2004 and later Floating license for one user, engineering software, software and documentation on CD, license key on USB stick, Class A, 3 languages (German/English/French), communication through the system interface, integrated graphics editor</p>	<p>3ZS1312-5CC10-0YE5</p>
<p>Powerpack for SIMOCODE ES 2007 Basic Floating license for one user, engineering software, license key on USB stick, Class A, 3 languages (German/English/French), communication through the system interface, integrated graphics editor</p>	<p>3ZS1312-5CC10-0YD5</p>
<p>Software Update Service For 1 year with automatic extension, assuming the current software version is in use, engineering software, software and documentation on CD, communication through the system interface, integrated graphics editor</p>	<p>3ZS1312-5CC10-0YL5</p>
SIMOCODE ES 2007 Premium	
<p>Floating license for one user Engineering software, software and documentation on CD, 3 languages (German/English/French), communication through PROFIBUS/PROFINET or system interface, integrated graphics editor, STEP7 Object Manager</p> <ul style="list-style-type: none"> • License key on USB stick, Class A • License key download, Class A 	<p>3ZS1312-6CC10-0YA5 3ZS1312-6CE10-0YB5</p>
<p>Upgrade for SIMOCODE ES 2004 and later Floating license for one user, engineering software, software and documentation on CD, license key on USB stick, Class A, 3 languages (German/English/French), communication through PROFIBUS/PROFINET or system interface, integrated graphics editor, STEP7 Object Manager</p>	<p>3ZS1312-6CC10-0YE5</p>
<p>Powerpack for SIMOCODE ES 2007 Standard Floating license for one user, engineering software, license key on USB stick, Class A, 3 languages (German/English/French), communication through PROFIBUS/PROFINET or system interface, integrated graphics editor, STEP7 Object Manager</p>	<p>3ZS1312-6CC10-0YD5</p>
<p>Software Update Service For 1 year with automatic extension, assuming the current software version is in use, engineering software, software and documentation on CD, communication through PROFIBUS/PROFINET or system interface, integrated graphics editor, STEP7 Object Manager</p>	<p>3ZS1312-6CC10-0YL5</p>

Notes:

Please order PC cable separately, see page 3/293.

More information see Catalog IC 10, Chapter 14
 "Parameterization, Configuration and Visualization with SIRIUS",
 Industry Mall or Interactive Catalog CA 01.

PROFIBUS

SIMOCODE 3UF Motor Management and Control Devices

SIMOCODE pro

Accessories

Selection and ordering data (continued)

Version	Article No.
SIMOCODE pro block library for SIMATIC PCS 7 Version V8 with Advanced Process Library (APL)	
 <p>Engineering software V8 For one engineering station (single license) including runtime software for execution of the AS blocks in an automation system (single license), German/English Scope of supply: AS blocks and faceplates for integrating SIMOCODE pro into the PCS 7 process control system with Advanced Process Library, for PCS 7 version V8.0 Type of delivery: Software and documentation on CD, one license for one engineering station, one license for one automation system</p>	<p>3ZS1632-1XX02-0YA0</p>
<p>Runtime license V8 For execution of the AS blocks in an automation system (single license) Required for using the AS blocks of the engineering software V8 within a plant Type of delivery: One license for one automation system, without software and documentation</p>	<p>3ZS1632-2XX02-0YB0</p>
<p>Upgrade for SIMOCODE pro PCS 7 block library, V6.0 or V7 to the SIMOCODE pro V8 version For one engineering station (single license) including runtime software for execution of the AS blocks in an automation system (single license), German/English Scope of supply: AS blocks and faceplates for integrating SIMOCODE pro into the PCS 7 process control system, with Advanced Process Library for PCS 7 version V8.0 Type of delivery: Software and documentation on CD, one license for one engineering station, one license for one automation system</p>	<p>3ZS1632-1XX02-0YE0</p>

Notes:

Please order PC cable separately, see page 3/293.

More information see Catalog IC 10, Chapter 14 "Parameterization, Configuration and Visualization with SIRIUS", Industry Mall or Interactive Catalog CA 01.

Selection and ordering data (continued)

Version	Article No.
SIMOCODE pro block library for SIMATIC PCS 7 Version 7	
 <p>Engineering software V7 For one engineering station (single license) including runtime software for execution of the AS blocks in an automation system (single license), German/English/French Scope of supply: AS blocks and faceplates for integrating SIMOCODE pro into the PCS 7 process control system, for PCS7 version V7.0/V7.1 Type of delivery: Software and documentation on CD, one license for one engineering station, one license for one automation system</p>	3UF7982-0AA10-0
<p>Runtime license V7 For execution of the AS blocks in an automation system (single license) Required for using the AS blocks of the engineering software V7 or the engineering software migration V7-V8 on an additional automation system within a plant Type of delivery: One license for one automation system, without software and documentation</p>	3UF7982-0AA11-0
<p>Upgrade for SIMOCODE pro PCS 7 block library, V6.0 or V6.1 to version SIMOCODE pro V7.0/V7.1 For one engineering station (single license) including runtime software for execution of the AS blocks in an automation system (single license), German/English/French Scope of supply: AS blocks and faceplates for integrating SIMOCODE pro into the PCS 7 process control system, for PCS7 version V7.0/V7.1 Type of delivery: Software and documentation on CD, one license for one engineering station, one license for one automation system</p>	3UF7982-0AA13-0
<p>Engineering software migration V7-V8 For upgrading (migrating) an existing engineering software V7 of the SIMOCODE pro block library for PCS 7 Conditions of use: Availability of the engineering software V7 (license) of the SIMOCODE pro block library for PCS 7 for the PCS 7 version V7.0 or V7.1 The engineering software migration V7-V8 can be installed directly onto a system with PCS 7 version V8.0; installation of the previous version is unnecessary. For one engineering station (single license) including runtime software for execution of the AS blocks in an automation system (single license), German/English/French Scope of supply: AS blocks and faceplates for integrating SIMOCODE pro into the PCS 7 process control system, for PCS 7 version V8.0 Type of delivery: software and documentation on CD, license for upgrading an existing license for one engineering station and a plant's assigned runtime licenses</p>	3UF7982-0AA20-0

Notes:

Please order PC cable separately, see page 3/293.

More information see Catalog IC 10, Chapter 14
 "Parameterization, Configuration and Visualization with SIRIUS",
 Industry Mall or Interactive Catalog CA 01.

Programming and Operating Manual SIMOCODE pro Library for PCS 7 see
<http://support.automation.siemens.com/WW/view/en/49963525>.

PROFIBUS



SIMOCODE 3UF Motor Management and Control Devices

3UF18 current transformers for overload protection

Overview

The 3UF18 current transformers are protection transformers and are used for actuating overload relays. Protection transformers are designed to ensure proportional current transfer up to a multiple of the primary rated current. The 3UF18 current transformers convert the maximum current of the corresponding operating range into the standard value of 1 A secondary.

Selection and ordering data

	Mounting type	Operating range A	Screw terminals Article No.
For stand-alone installation			
 3UF1843	Screw fixing and snap-on mounting onto TH 35 standard mounting rail according to IEC 60715	0.25 ... 2.5 ¹⁾	3UF1843-1BA00
		1.25 ... 12.5 ¹⁾	3UF1843-2AA00
		2.5 ... 25 ¹⁾	3UF1843-2BA00
		12.5 ... 50	3UF1845-2CA00
		16 ... 65	3UF1847-2DA00
		25 ... 100	3UF1848-2EA00
For mounting onto contactors and stand-alone installation			
 3UF1868	Screw fixing	32 ... 130	3UF1850-3AA00
		50 ... 200	3UF1852-3BA00
		63 ... 250	3UF1854-3CA00
		100 ... 400	3UF1856-3DA00
		125 ... 500	3UF1857-3EA00
		160 ... 630	3UF1868-3FA00
205 ... 820	3UF1868-3GA00		

¹⁾ The following setting ranges for the protection of EEx e motors are applicable:
 3UF1843-1BA00, 0.25 ... 1.25 A;
 3UF1843-2AA00, 1.25 ... 6.3 A;
 3UF1843-2BA00, 2.5 ... 12.5 A.

Accessories

	For contactor type	Article No.
Terminal covers		
 3TX7466-0A	For transformer/contactor assemblies and stand-alone installation for transformer (cover required per connection side)	
	3UF1845	3TX7446-0A
	3UF1848	3TX7466-0A
	3UF1850, 3UF1852	3TX7506-0A
	3UF1854 to 3UF1857	3TX7536-0A
	3UF1868-3FA00	3TX7686-0A
3UF1868-3GA00	3TX7696-0A	
	For covering the screw terminal for direct mounting on contactor (cover required per contactor/transformer assembly)	
3UF1848	3TX7466-0B	
3UF1850, 3UF1852	3TX7506-0B	
3UF1854 to 3UF1857	3TX7536-0B	
3UF1868-3FA00	3TX7686-0B	
3UF1868-3GA00	3TX7696-0B	

Overview



SIRIUS 3RK3 Modular Safety System

The 3RK3 Modular Safety System (MSS) is a freely parameterizable modular safety relay. Depending on the external circuit version, safety-related applications up to Performance Level e according to EN ISO 13849-1 or SIL 3 according to IEC 62061 can be realized.

The modular safety relay enables the interconnection of several safety applications.

The comprehensive error and status diagnostics provides the possibility of finding errors in the system and localizing signals from sensors. Plant downtimes can be reduced as the result.

The MSS comprises the following system components:

- Central units
- Expansion modules
- Interface modules
- Diagnostics modules
- Parameterization software
- Accessories

Central units

MSS Basic

The 3RK3 Basic central unit is used wherever more than three safety functions need to be evaluated and the wiring parameterization of safety relays would involve great cost and effort. It reads in inputs, controls outputs, and communicates through an interface module with higher-level control systems. An application's entire safety program is processed in the central unit. The 3RK3 Basic central unit is the lowest expansion level and fully functional on its own, without the optional expansion modules.

MSS Advanced

The 3RK3 Advanced central unit is the consistent expansion of the Basic central unit with the functionality of an AS-i safety monitor. In addition to having a larger volume of project data and scope of functionality it can be integrated in AS-Interface and therefore make use of the many different possibilities offered by this bus system. The function can be optionally activated in the central unit.

The service-proven insulation piercing method of AS-Interface enables not only the distributed expansion of the project data volume using safe AS-i outputs, safe AS-i sensors and other MSS Advanced or safety monitors (F cross traffic) but also a highly flexible adaptation of the application, e.g. very fast connection of AS-i outputs such as LV HRC command devices, position switches with and without interlock, or light curtains.

Safety-related disconnection using MSS or by distributed means using safe AS-i outputs and the formation of switch-off groups can be realized very easily. The same applies for any subsequent modifications. They are now easily possible by re-addressing, i.e. re-wiring is no longer necessary.

The AS-i bus is connected directly to the central unit.

MSS ASIsafe

The MSS ASIsafe basic and MSS ASIsafe extended central units are a logical development of the AS-i safety monitors based on the 3RK3 Modular Safety System.

Like MSS Advanced, MSS ASIsafe detects – in a comparable way to the safety monitors – safe sensor technology on the AS-i bus and switches actuators off in a safety-related manner via a configurable safety logic. It stands out by virtue of its greater project data volume, wider range of functions and the possibility of increasing the integrated I/O project data volume by means of expansion modules from the MSS system family. In this case the range of functions, such as the number and type of the logic elements that can be interconnected, is equivalent to that of MSS Advanced.

Expansion modules

With the optional expansion modules, both safety-related and standard, the system is flexibly adapted to the required safety applications.

Interface modules

The DP interface module is used for transferring diagnostics data and device status data to a higher-level PROFIBUS network, e.g. for purposes of visualization using HMI. When using the Basic central unit, 32-bit cyclic data can be exchanged with the control system. If an Advanced/ASIsafe central unit is used, the number is doubled to 64-bit cycle data. The acyclic calling of diagnostics data is possible with all central units.

Diagnostics modules

Faults, e.g. cross-circuit, are indicated directly on the diagnostics display. The fault is diagnosed directly in plain text by the detailed alarm message. The device is fully functional upon delivery. No programming is required.

Parameterization software

Using the MSS ES graphical parameterization tool it is very easy to create the safety functions as well as their logical links on the PC. It is therefore possible to define disconnection ranges, ON-delays, OFF-delays and other dependencies for example.

MSS ES also offers comprehensive functions for diagnostics and commissioning. Documentation of the MSS hardware configuration and the parameterized logic is created automatically.

PROFIBUS

SIRIUS 3RK3 Modular Safety System

General data

Overview (continued)

3

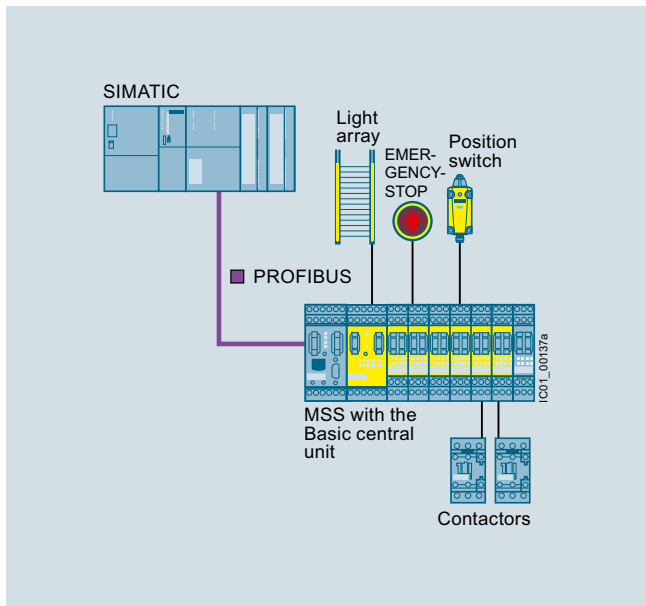

System configuration with the Basic central unit

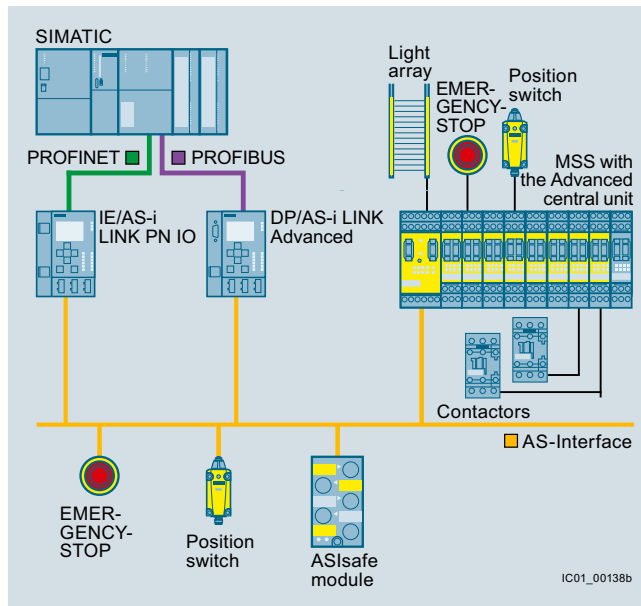

System configuration with the Advanced central unit

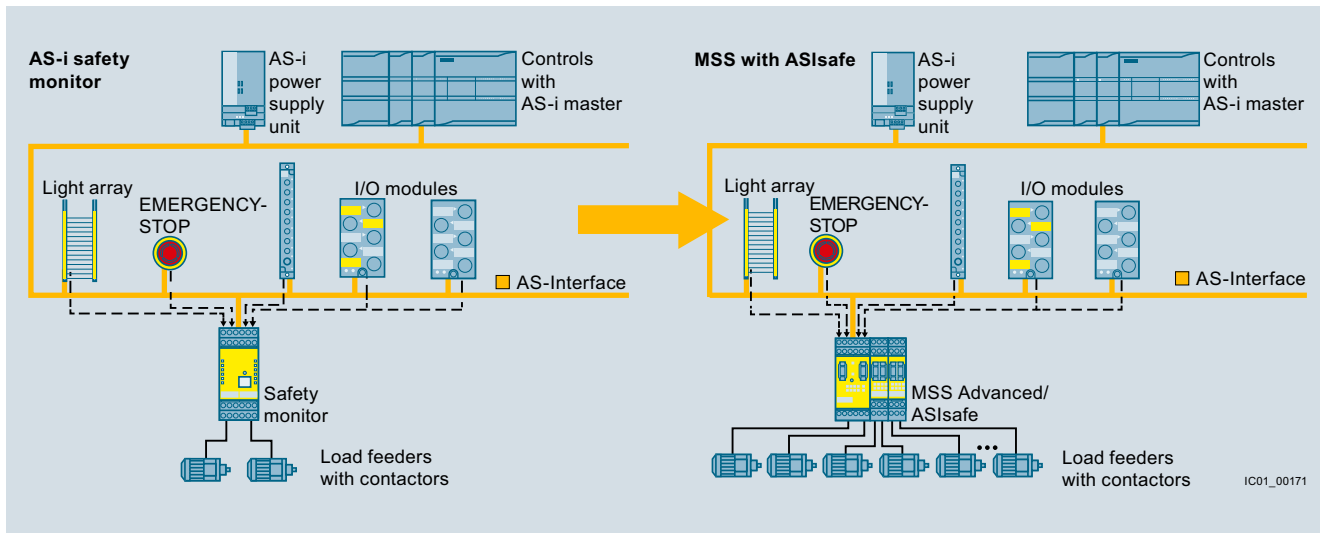

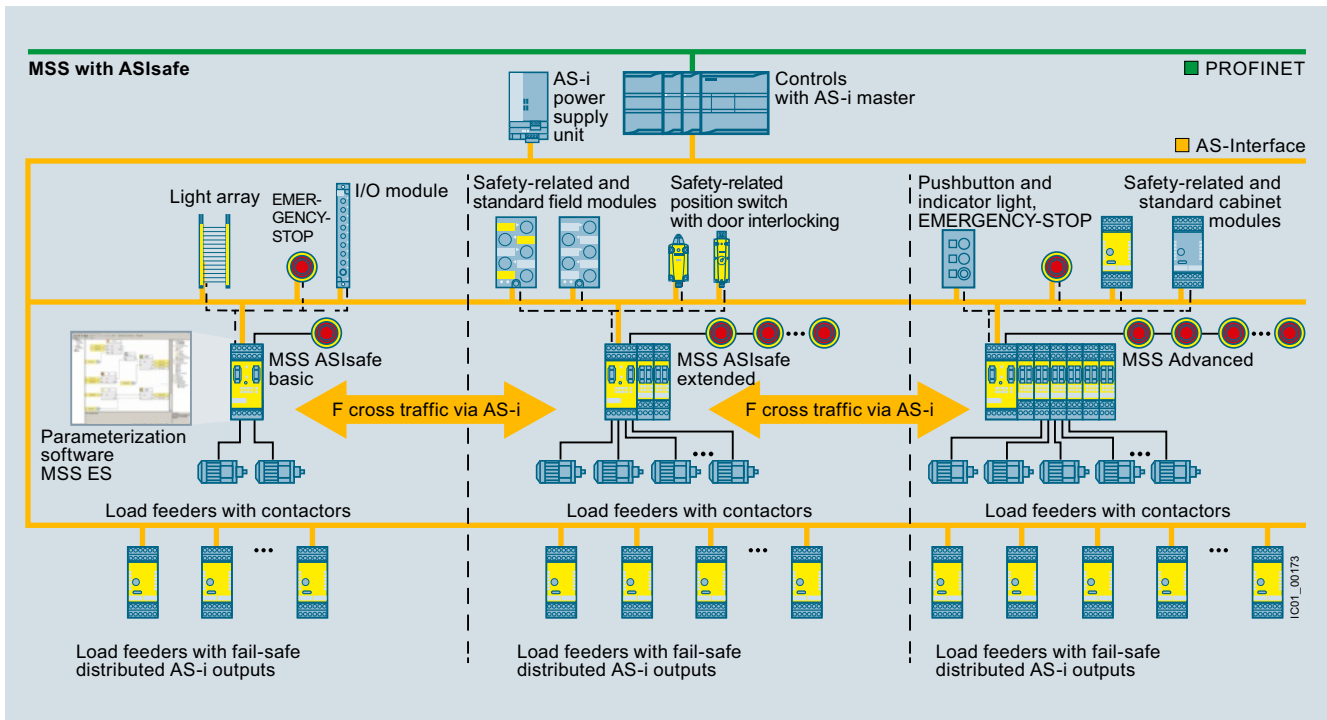

Further development of the system design: from the safety monitor to MSS Advanced/MSS ASIsafe

Overview (continued)

MSS with ASIsafe

Connection methods

Selection tables for the SIRIUS 3RK3 Modular Safety System can be found on the following pages.

-  Screw terminals
-  Spring-type terminals

Benefits

- More functionality and flexibility through freely configurable safety logic
- Suitable for all safety applications thanks to compliance with the highest safety standards in factory automation
- For use all over the world through compliance with all product-relevant, globally established certifications
- Modular hardware configuration
- Parameterization by means of software instead of wiring
- Removable terminals for greater plant availability
- Distributed collection from sensors and disconnection of actuators through AS-Interface
- All MSS ES logic functions are also usable for AS-Interface, e. g. muting, interlocking protective door
- Up to 12 independent safe switch-off groups on the AS-i bus
- Volume of project data can be greatly increased by means of AS-Interface
- Up to 50 two-channel enabling circuits per system

PROFIBUS

SIRIUS 3RK3 Modular Safety System

General data

Benefits (continued)

Communication via PROFIBUS

The 3RK3 Modular Safety System can be connected to PROFIBUS through the DP interface and exchange data with higher-level control systems.

The MSS supports among other things:

- Baud rates up to 12 Mbit/s
- Automatic baud rate detection
- Cyclic services (DPV0) and acyclic services (DPV1)
- Exchange of 32-bit cyclic data with MSS Basic or 64-bit cyclic data with MSS Advanced/MSS ASIsafe
- Diagnostics using data record invocations

AS-Interface communication

Using the Advanced and ASIsafe central units, the 3RK3 Modular Safety System can be integrated in AS-Interface.

- MSS can read in up to 31 AS-i sensors
- Up to 12 preprocessed signals per MSS can be placed on the AS-i bus, e.g. for F cross traffic or for disconnecting safe AS-i outputs
- Safe cross traffic between MSS Advanced and MSS ASIsafe or between other AS-i safety monitors
- Standard signals, e.g. for acknowledgment, can also be applied to the bus

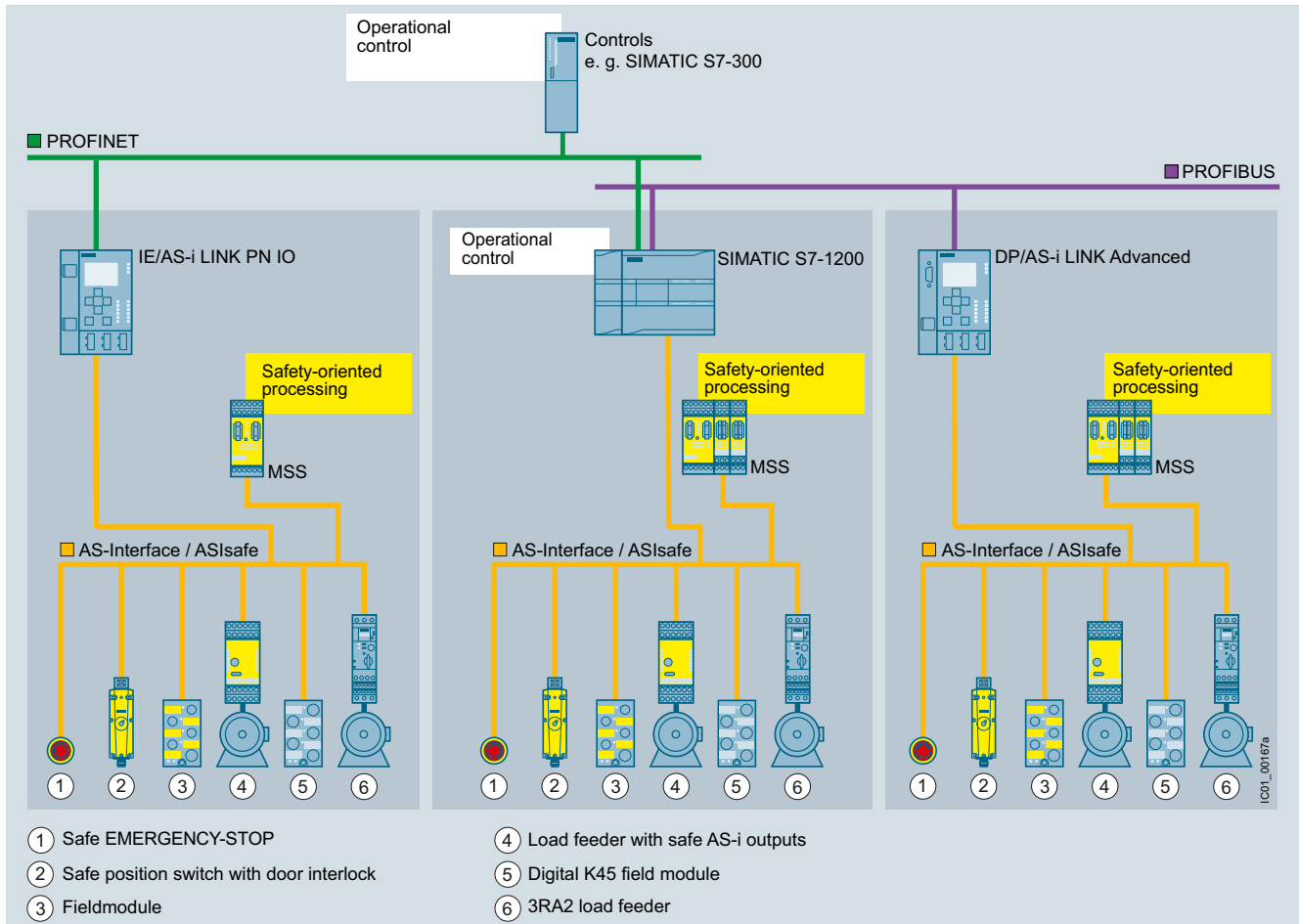

Integration of MSS into AS-Interface as ASIsafe Solution local

Notes:

MSS with communication function see page 3/306 onwards.









Accessories see page 3/308 onwards.

More information about AS-Interface with ASIsafe see Chapter 4 (AS-Interface).

More information about MSS ES see also Catalog IC 10, Chapter 14 "Parameterization, Configuration and Visualization with SIRIUS", Industry Mall or Interactive Catalog CA 01.





















Application

The 3RK3 Modular Safety System can be used for all safety-related requirements in the manufacturing industry and offers the following safety functions:

	Symbol	MSS Basic	MSS Advanced, MSS ASIsafe
<i>Monitoring functions</i>			
Universal monitoring Evaluation of any binary signals from single-channel and two-channel sensors		--	✓
EMERGENCY-STOP Evaluation of EMERGENCY-STOP devices with positive-opening contacts		✓	✓
Safety shutdown mats Evaluation of safety shutdown mats with NC contacts and/or cross-circuit detection		✓	✓
Protective door monitoring Evaluation of protective door signals and/or protective flap signals		✓	✓
Protective door interlocking Evaluation of protective doors with interlock and of the actuation/release of this interlock		--	✓
Enabling switches Evaluation of enabling buttons with NO contact		✓	✓
Two-hand operation Evaluation of two-hand operator controls		✓	✓
ESPE monitoring Evaluation of non-contact protective devices, e.g. light curtains and laser scanners		✓	✓
Muting Temporary bridging of non-contact protective devices, 2/4 sensors in parallel, 4 sensors in sequence		--	✓
Operating mode selector switches Evaluation of operating mode selector switches with NO contacts		✓	✓
Monitoring AS-i (AS-i 2F-DI) Logic element for monitoring of AS-i input slaves		--	✓

✓ Available

-- Not available

	Symbol	MSS Basic	MSS Advanced, MSS ASIsafe
<i>Logic functions</i>			
AND		✓	✓
OR		✓	✓
XOR		✓	✓
NAND		✓	✓
NOR		✓	✓
Negation		✓	✓
Flip-flop		✓	✓
<i>Counting functions</i>			
Counter 0 -> 1		✓	✓
Counter 1 -> 0		✓	✓
Counter 0 -> 1/1 -> 0		✓	✓
<i>Timer functions</i>			
With ON-delay		✓	✓
Passing make contact		✓	✓
With OFF-delay		✓	✓
Clock-pulsing		✓	✓
<i>Start functions</i>			
Monitored start		✓	✓
Manual start		✓	✓
<i>Output functions</i>			
Standard output		✓	✓
F output		✓	✓
AS-i output function		--	✓
<i>Status functions</i>			
Element status		--	✓

More information

System manual "3RK3 Modular Safety System" see
<http://support.automation.siemens.com/WW/view/en/26493228>.

PROFIBUS**SIRIUS 3RK3 Modular Safety System****3RK31 central units****Selection and ordering data**

3RK3111-1AA10

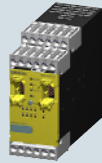
3RK3121-1AC00
3RK3122-1AC00
3RK3131-1AC10

Version

Screw terminals



Spring-type terminals



Article No.

Article No.

3RK31 central units**3RK3 Basic**

Central unit with safety-related inputs and outputs

- 8 fail-safe inputs
- 1 two-channel relay output
- 1 two-channel electronic output

Max. 7 expansion modules can be connected

Note:

Memory module 3RK3931-0AA00 is included in the scope of supply.

3RK3111-1AA10**3RK3111-2AA10****3RK3 Advanced**

Central units for connecting to AS-Interface with safety-related inputs and outputs and extended scope of functions

- 8 fail-safe inputs
- 1 two-channel relay output
- 1 two-channel electronic output

Max. 9 expansion modules can be connected

Note:

Memory module 3RK3931-0AA00 is included in the scope of supply.

3RK3131-1AC10**3RK3131-2AC10****3RK3 ASIsafe**

Central units for connecting to AS-Interface with safety-related inputs and outputs and extended scope of functions

- 1 two-channel relay output
- 1 two-channel electronic output

"Basic" version

- 2 fail-safe inputs
 - 6 non-fail-safe inputs
- No expansion modules can be connected

"Extended" version

- 4 fail-safe inputs
 - 4 non-fail-safe inputs
- Max. 2 expansion modules can be connected







Note:

Memory module 3RK3931-0AA00 is included in the scope of supply.

3RK3121-1AC00**3RK3121-2AC00****3RK3122-1AC00****3RK3122-2AC00**Notes:More information on MSS see
www.siemens.com/sirius-mss.

More information on AS-Interface see Chapter 4 (AS-Interface).

3RK32/33 expansion modules, 3RK35 interface modules, 3RK36 operating and monitoring modules
Selection and ordering data (continued)

				
3RK3211-1AA10 3RK3221-1AA10 3RK3231-1AA10 3RK3242-1AA10	3RK3251-1AA10	3RK3311-1AA10 3RK3321-1AA10	3RK3511-1BA10	3RK3611-3AA00
Version			Screw terminals 	Spring-type terminals 
			Article No.	Article No.

3RK32, 3RK33 expansion modules
4/8 F-DI

 Safety-related input modules
 • 8 inputs

3RK3211-1AA10
3RK3211-2AA10
2/4 F-DI 1/2 F-RO

 Safety-related input/output modules
 • 4 inputs
 • 2 single-channel relay outputs

3RK3221-1AA10
3RK3221-2AA10
2/4 F-DI 2F-DO

 Safety-related input/output modules
 • 4 inputs
 • 2 two-channel electronic outputs

3RK3231-1AA10
3RK3231-2AA10
4/8 F-RO

 Safety-related output modules
 • 8 single-channel relay outputs

3RK3251-1AA10
3RK3251-2AA10
4 F-DO

 Safety-related output modules
 • 4 two-channel electronic outputs

3RK3242-1AA10
3RK3242-2AA10
8 DI

 Standard input module
 • 8 inputs

3RK3321-1AA10
3RK3321-2AA10
8 DO

 Standard output module
 • 8 electronic outputs

3RK3311-1AA10
3RK3311-2AA10
3RK35 interface modules
DP interface

 PROFIBUS DP interface, 12 Mbit/s, RS 485,
 32-bit cyclic data exchange with Basic central unit
 or 64-bit with Advanced and ASIsafe central unit,
 acyclic exchange of diagnostics data

3RK3511-1BA10
3RK3511-2BA10
3RK36 operating and monitoring modules
Diagnostics module
3RK3611-3AA00

--









Notes:

Connection cable required, see page 3/308.

 More information on MSS see
www.siemens.com/sirius-mss.

 More information on AS-Interface see Chapter 4
 (AS-Interface).

PROFIBUS**SIRIUS 3RK3 Modular Safety System****Accessories****Selection and ordering data** (continued)

Version	Article No.
Connection cables (essential accessory)	
 <p>Connection cable For connection of Central units with expansion modules or interface module</p> <p>3UF7932-0AA00-0</p>	<p>Diagnostics modules with central unit or interface module</p> <p>✓</p> <p>• Length 0.025 m (flat)</p> <p>3UF7930-0AA00-0</p> <p>--</p> <p>• Length 0.1 m (flat)</p> <p>3UF7931-0AA00-0</p> <p>--</p> <p>• Length 0.3 m (flat)</p> <p>3UF7935-0AA00-0</p> <p>--</p> <p>• Length 0.5 m (flat)</p> <p>3UF7932-0AA00-0</p> <p>--</p> <p>• Length 0.5 m (round)</p> <p>3UF7932-0BA00-0</p> <p>--</p> <p>• Length 1.0 m (round)</p> <p>3UF7937-0BA00-0</p> <p>--</p> <p>• Length 2.5 m (round)</p> <p>3UF7933-0BA00-0</p>
PC cables and adapters	
 <p>RS 232 PC cables For connecting to the serial interface of a PC/PG, for communication with 3RK3 through the system interface</p> <p>3UF7940-0AA00-0</p>	<p>3UF7940-0AA00-0</p>
 <p>USB PC cables For connecting to the USB interface of a PC/PG, for communication with 3RK3 through the system interface, recommended for use in connection with 3RK3</p> <p>3UF7941-0AA00-0</p>	<p>3UF7941-0AA00-0</p>
 <p>USB/serial adapters For connecting an RS 232 PC cable to the USB interface of a PC</p> <p>3UF7941-0AA00-0</p>	<p>3UF7946-0AA00-0</p>
Door adapters	
 <p>Door adapters For external connection of the system interface, e.g. outside a control cabinet</p> <p>3UF7920-0AA00-0</p>	<p>3UF7920-0AA00-0</p>
Interface covers	
 <p>Interface cover For system interface</p> <p>3UF7950-0AA00-0</p>	<p>3UF7950-0AA00-0</p>
Memory modules	
 <p>Memory modules For backing up the complete parameterization of the 3RK3 Modular Safety System without a PC/PG through the system interface</p> <p>3RK3931-0AA00</p>	<p>3RK3931-0AA00</p>
Push-in lugs	
 <p>Push-in lugs for screw fixing e.g. on mounting plate, 2 units required per device Can be used for 3RK3</p> <p>3RP1903</p>	<p>3RP1903</p>

✓ Available

-- Not available



Note:

More accessories and components that can be combined with MSS see Chapter 4 (AS-Interface).

Selection and ordering data (continued)

Parameterization, start-up and diagnostics software for 3RK3

- Runs under Windows XP Professional (Service Pack 2 or 3), Windows 7 32/64-bit Professional/Ultimate/Enterprise (Service Pack 1)
- Delivered without PC cable (please order separately, see page 3/308)

	Version	Article No.
Modular Safety System ES 2008 Basic		
	Floating license for one user Engineering software in limited-function version for diagnostics purposes, software and documentation on CD, 3 languages (German/English/French), communication through system interface <ul style="list-style-type: none"> • License key on USB stick, Class A • License key download, Class A 	3ZS1314-4CC10-0YA5 3ZS1314-4CE10-0YB5
3ZS1314-4CC10-0YA5		
Modular Safety System ES 2008 Standard		
	Floating license for one user Engineering software, software and documentation on CD, 3 languages (German/English/French), communication through system interface <ul style="list-style-type: none"> • License key on USB stick, Class A • License key download, Class A 	3ZS1314-5CC10-0YA5 3ZS1314-5CE10-0YB5
3ZS1314-5CC10-0YA5		
	Powerpack for MSS ES 2008 Basic to Standard Floating license for one user, engineering software, license key on USB stick, Class A, 3 languages (German/English/French), communication through system interface	3ZS1314-5CC10-0YD5
	Software Update Service For 1 year with automatic extension, assuming the current software version is in use, engineering software, software and documentation on CD, communication through system interface	3ZS1314-5CC10-0YL5
Modular Safety System ES 2008 Premium		
	Floating license for one user Engineering software, software and documentation on CD, 3 languages (German/English/French), communication through PROFIBUS or the system interface, online diagnostics via PROFIBUS, creating, importing and exporting macros <ul style="list-style-type: none"> • License key on USB stick, Class A • License key download, Class A 	3ZS1314-6CC10-0YA5 3ZS1314-6CE10-0YB5
3ZS1314-6CC10-0YA5		
	Powerpack for MSS ES 2008 Standard to Premium Floating license for one user, engineering software, license key on USB stick, Class A, 3 languages (German/English/French), communication through PROFIBUS or the system interface, online diagnostics via PROFIBUS, creating, importing and exporting macros	3ZS1314-6CC10-0YD5
	Software Update Service For 1 year with automatic extension, assuming the current software version is in use, engineering software, software and documentation on CD, communication through PROFIBUS or the system interface, online diagnostics via PROFIBUS, creating, importing and exporting macros	3ZS1314-6CC10-0YL5

Note:

Description of the software versions see Catalog IC 10, Chapter 14 "Parameterization, Configuration and Visualization with SIRIUS", Industry Mall or Interactive Catalog CA 01.

PROFIBUS

Switching and Protection Devices for Power Distribution

SENTRON Communication-Capable Circuit Breakers

Overview

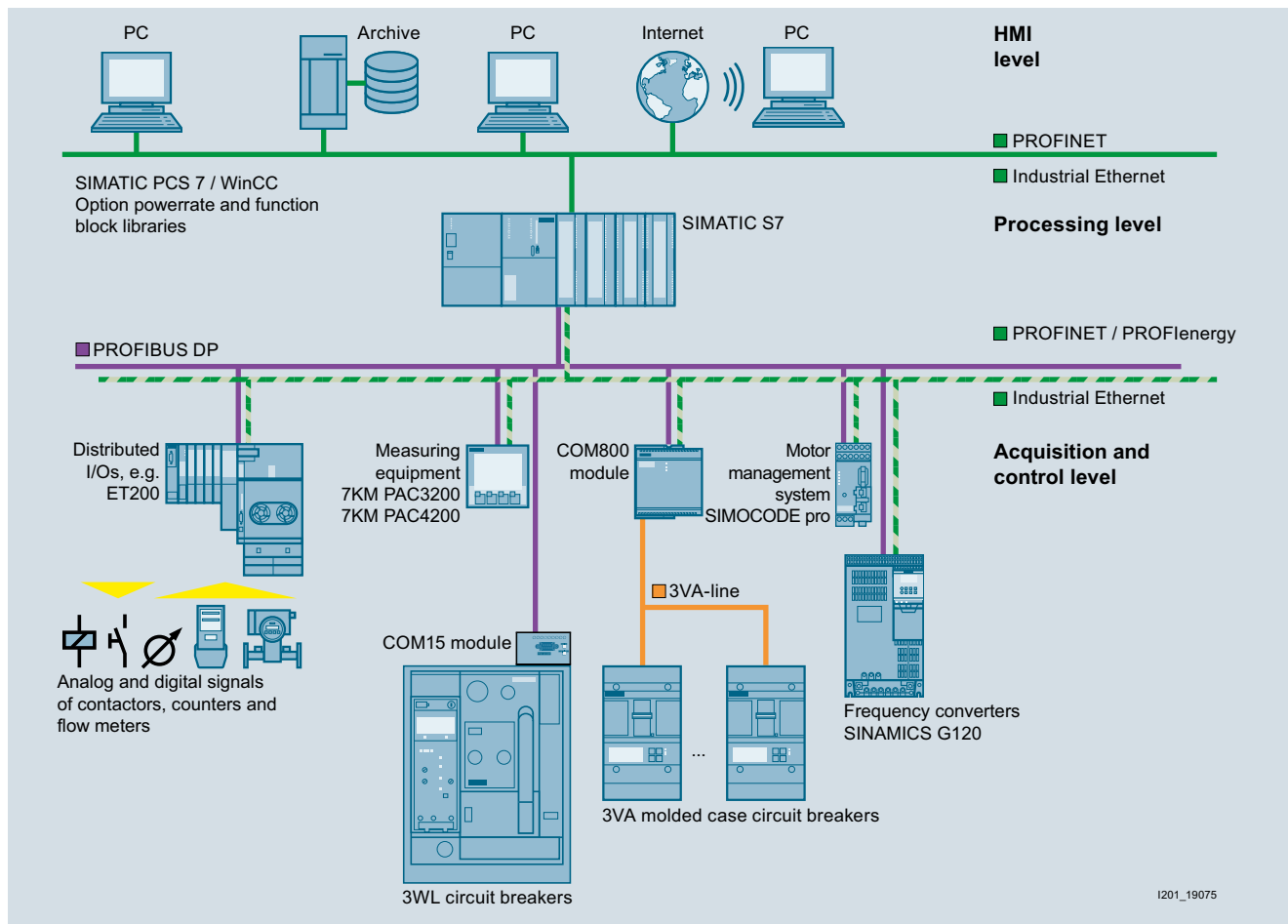

For more information about communication-capable SENTRON circuit breakers, see

- "3VA molded case circuit breakers" Product Information
- Catalog LV 10, Chapters 1 and 2
- Industry Mall, Sections "Building Technologies/Low-Voltage Power Distribution and Electrical Installation Technology"/"Protection Devices"/
 - "Molded Case Circuit Breakers"/**"SENTRON 3VA Molded Case Circuit Breakers"**
 - "Molded Case Circuit Breakers"/**"SENTRON 3VL Molded Case Circuit Breakers"**
 - "Air Circuit Breakers"/**"SENTRON 3WL Air Circuit Breakers"**

Overview

Power monitoring system with the SENTRON product family



Components of the PC-based power monitoring system

The SENTRON product family offers the user not only power monitoring software in the form of SENTRON powermanager but also the corresponding hardware in the form of 7KT/7KM PAC measuring instruments and 3WL/3VL circuit breakers for the realization of a complete power monitoring system.

The components are optimally coordinated with each other. For example, special drivers for the SENTRON devices are integrated in the powermanager software so that on the one hand the power data acquisition can take place without any great configuration effort and, on the other hand, the most important measured values or states are indicated by predefined displays.

This reduces the engineering work for the customer and gives the user the assurance of knowing that the device functions are optimally supported in the software. Power monitoring software, powermanager.

Features of powermanager



User interface of powermanager

The power monitoring software powermanager is the central feature of the PC-based power monitoring system and

- is an independent power monitoring software.
- can be operated using a PC and measuring devices with Ethernet connection.
- is expandable from the simple standard application to a fully flexible customer solution.
- is fully scalable with regard to the number of devices and to the software's functions.
- ensures the optimum integration of measuring instruments from the 7KT/7KM PAC range, 3WL/3VL circuit breakers and other modbus devices.

PROFIBUS

Power Monitoring

PC-based Power Monitoring System

Benefits

- Transparency of power flows
- Exact knowledge of the consumption profile
- Increase in energy efficiency
- Optimization of power supply contracts
- Compliance with contractual terms
- Assignment of power costs to cost centers
- Optimization of plant maintenance
- Identification of critical plant conditions
- Available languages:
- German, English, Spanish, Portuguese
- Support of the various device communication interfaces (Modbus RTU, Modbus TCP)
- Status display of devices

Application

Applications

The product offers a standard power monitoring solution which provides the user with the following basic functions:

- Collection of measured quantities from the devices
- Presentation of the measured quantities from the devices in a predefined standard view for the 7KT PAC1500, 7KM PAC3100, 7KM PAC3200, 7KM PAC4200 measuring instruments and 3WL/3VL circuit breakers
- Free presentation of measured quantities possible, including from non-Siemens devices using generic Modbus drivers
- Archiving of measured quantities
- Monitoring of status and limits, with generation of corresponding signals
- Load curve display for visualizing the archived data and online data
- Cost center reports based on predefined tariffs and archived consumption data
- OPC server
- Configuration of the system including user management
- Load monitoring for complying with power limits
- Virtual computation

This standard solution is designed with cost-efficiency and simple system commissioning in mind.

System configuration

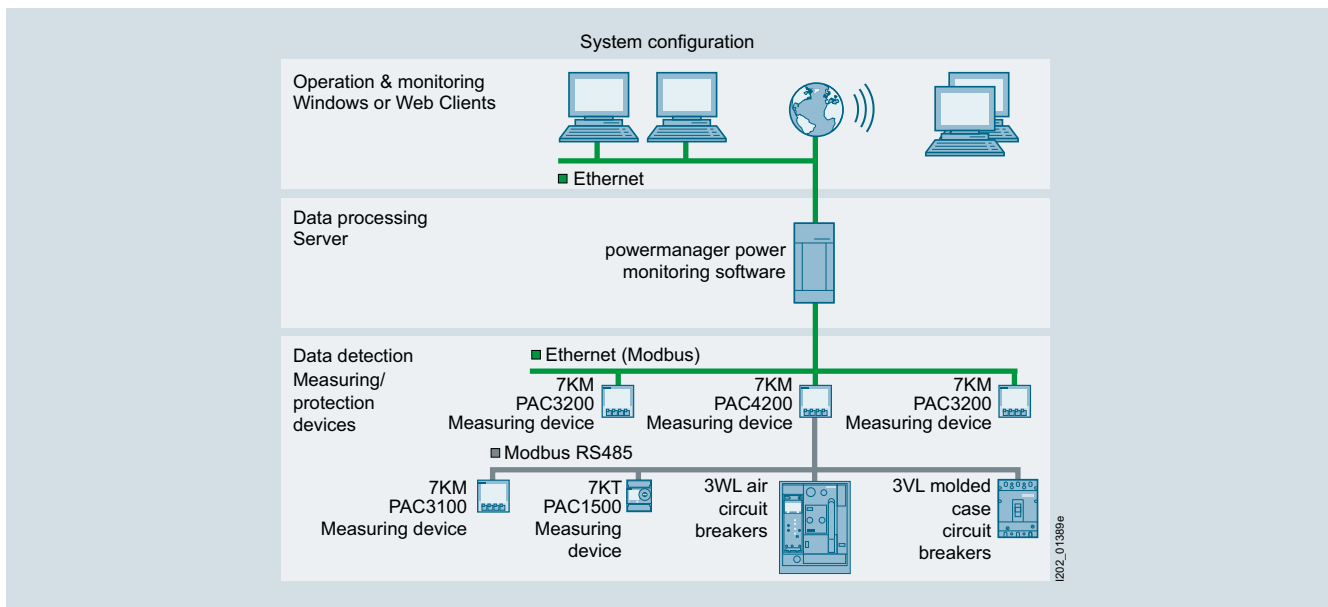

- Integration of measuring devices by means of predefined device templates for the 7KT/7KM PAC measuring devices and the 3WL/3VL circuit breakers
- Integration of existing Modbus-capable
- detecting devices is easy
- Communication through Standard Ethernet
- Integration of devices with RS 485 interface (ModbusRTU) through Modbus gateway, e. g. the 7KM PAC4200 measuring device can be used as gateway

Industries

The energy efficiency that can be achieved with consistent power monitoring and the derived optimization measures is crucial for all industries, e. g. in the manufacturing industry, in non-residential buildings, in the field of services, and in infrastructure projects. This has a particular impact on competitiveness, particularly in view of rising energy prices.

More information**TÜV certification**

TÜV Rhineland Certificate for SENTRON powermanager

Hardware components

Hardware components of the PC-based power monitoring system are

- 7KM PAC measuring devices, see measuring devices
- 3WL air circuit breakers, see SENTRON protection, switching, measuring and monitoring devices > Protective devices > Air circuit breakers
- 3VL molded case circuit breakers, see SENTRON protection, switching, measuring and monitoring devices > Protective devices > Molded case circuit breakers

Software

The software for the PC-based power monitoring system is powermanager, see Low-voltage power distribution and electrical installation technology > Software > Configuring, visualizing and controlling with SENTRON

Internet

You can find more information on the Internet at:

<http://www.siemens.com/lowvoltage/powermonitoring>

PROFIBUS

Power Monitoring

SIMATIC-based Power Data Management System

Overview

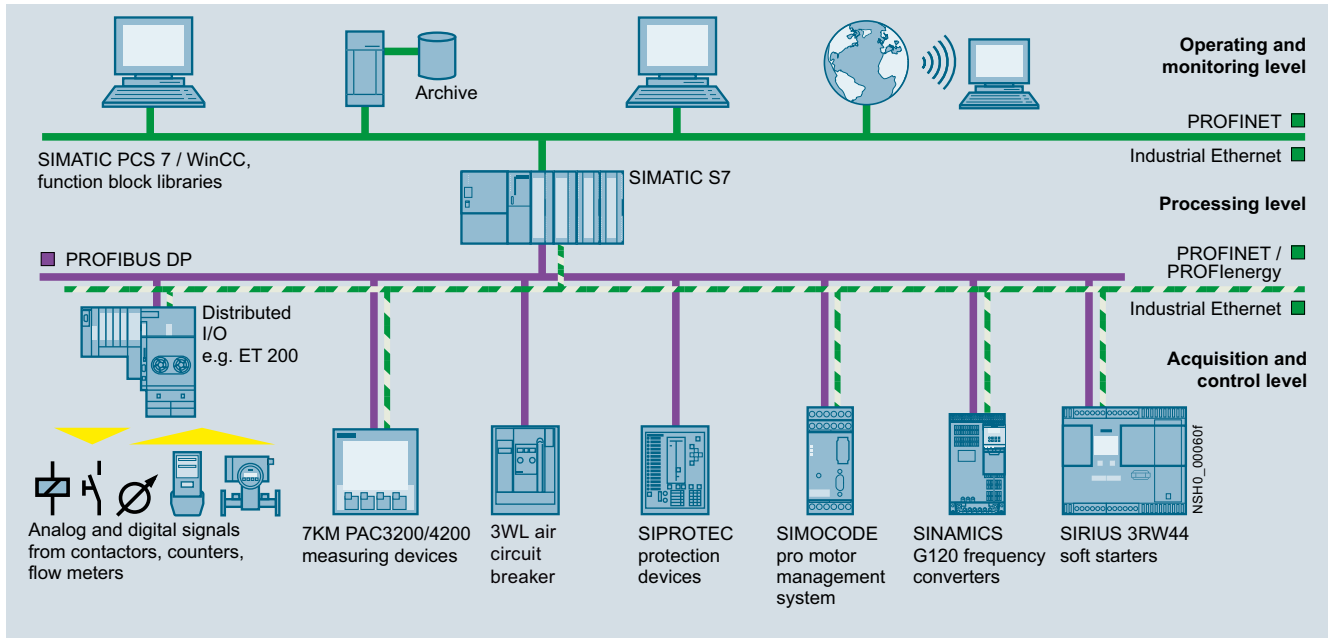

SIMATIC-based solutions for the process and manufacturing industry

A key feature of the process and manufacturing industry is its very high power consumption. It therefore makes sense to integrate an power data management system in existing systems.

Communication through PROFIBUS DP

PROFIBUS DP enables integration of a wide range of devices:

- For the protection of distribution boards and loads:
- protective devices, such as circuit breakers
- For control: frequency converters, motor management systems and soft starters
- For detection
 - electrical measured quantities: via the 7KM PAC3200/4200 measuring devices
 - non-electrical measured quantities: via analog/digital converters

PROFINET and PROFinergy

An increasing number of devices in automation technology offer PROFINET. A 7KM PAC Switched Ethernet PROFINET expansion module is also available for the 7KM PAC3200 und 7KM PAC4200 measuring devices.

PROFinergy is a "Common Application Profile" from the PNO. Thanks to PROFinergy it is possible to assemble an power data management system with standardized device interfaces.

Function block libraries for SIMATIC PCS 7 and WinCC

The function block library for SIMATIC PCS 7 and WinCC ensures device integration as follows:

- Measured quantities and states can be connected via CFC.
- Structured display of measured quantities and protection parameters for the 3WL/3VL circuit breakers.
- Limit value violations are displayed, archived and acknowledged in the relevant communications system in the usual way
- Circuit breakers can be program-controlled or manually operated with the appropriate user authorization

Benefits

- Increased energy efficiency due to exact knowledge of the load profile
- Optimization of power supply contracts
- Assignment of power costs to cost centers
- Optimization of plant maintenance
- Identification of critical plant conditions
- Reliable monitoring of the power limit through automatic load management

Application

The SIMATIC PCS 7 and WinCC library function blocks are used in all industries in which PCS 7 and WinCC are used, and the transparency and monitoring of power flows is crucial.

More information**Hardware components**

Hardware components of the SIMATIC-based power data management system are

- 7KM PAC measuring devices, see measuring devices
- 3WL air circuit breakers, see SENTRON protection, switching, measuring and monitoring devices > Protective devices > Air circuit breakers
- 3VL molded case circuit breakers, see SENTRON protection, switching, measuring and monitoring devices > Protective devices > Molded case circuit breakers

Software components

The software components of the SIMATIC-based power data management system are

- Library 7KM PAC3200 for SIMATIC PCS 7
- Library 3WL/3VL for SIMATIC PCS 7
- Library 7KM PAC3200 for SIMATIC WinCC

All software components, see Low-voltage power distribution and electrical installation technology > Software > Configuring, visualizing and controlling with SIMATIC

Internet

You can find more information on the Internet at:

<http://www.siemens.com/lowvoltage/powermonitoring>

PROFIBUS SENTRON Measuring Devices

7KM PAC3200 Measuring Devices

Overview



7KM PAC measuring devices: 7KM PAC3200 (left), 7KM PAC3100 (center) and 7KM PAC4200 (right)

7KM PAC Measuring Devices

The 7KM PAC measuring devices are used to measure and indicate all relevant network parameters in low-voltage power distribution. They can be used for single-phase measurements as well as for multiphase measurements in 3 and 4-conductor networks (TN, TT, IT).

Energy values for main distribution boards, electrical feeders or individual loads are recorded precisely and reliably, and important measured values are supplied in addition for assessing the state of the plant and the quality of the network.

The 7KM PAC3100 measuring device is fitted with an integrated Modbus RTU interface via RS485, which means there is no need for an expansion module.

The specialist solution for precise energy measurement



SENTRON PAC3200 measuring device, English

When, where, and how much energy is used – transparent information is provided by the new 7KM PAC3200 measuring device. This device can be used wherever electrical energy is distributed. 7KM PAC3200 records more than 50 electrical parameters such as voltage, current, power, energy values, frequency, power factor and symmetry. The compact and high-performance power monitoring device records all consumption data extremely accurately and reliably.

Benefits

- Simple mounting and commissioning
- High IP65 degree of protection (front side, when installed) permits use in extremely dusty and wet environments
- Intuitive operation via 4 function buttons and multilingual plain text displays
- Easy adaptation to different systems using integrated and optional digital inputs and outputs
- Communication interfaces
- Worldwide use
- Min. 8 languages
- International approvals
- Developed and tested to European and international standards
- Low mounting depth

Additional performance characteristics of the 7KM PAC3200

- Precise energy recording
- Versatile system integration
 - Integrated Ethernet interface
 - Optional communication modules available
 - Multifunctional digital inputs and outputs
 - Limit monitoring
- Can be connected directly to power supply networks up to 690V AC (UL-L) and CATIII without voltage transformers (with the exception of devices with power supply units with extra-low voltage).
- Easy-to-use configuration software powerconfig included in the scope of delivery

Ordering data	Article No.	More information
7KM PAC3200 measuring device Control panel instrument 96 mm x 96 mm screw connections for current and voltage connection AC/DC wide-range power supply unit U_{AUX} : 95 ... 240 V AC \pm 10 %, 50/60 Hz 110 ... 340 V DC \pm 10 % Measuring inputs U_e : max. 3 AC 690/400 V, 50/60 Hz I_e : /1 A or /5 A	7KM2112-0BA00-3AA0	Accessories For accessories, see Catalog LV 10 Current transformers Suitable current transformers can be found in the Catalog LV 10 under "Molded case circuit breakers" Manual The manual/operating instructions for the SENTRON PAC3200 power monitoring device can be found on the Internet at http://support.automation.siemens.com/WW/view/en/25240652/133300
7KM PAC3200 measuring device Control panel instrument 96 mm x 96 mm screw connections for current and voltage connection DC extra-low voltage power supply unit U_{AUX} : 22 ... 65 V DC \pm 10 % Measuring inputs U_e : max. 3 AC 500/289 V, 50/60 Hz I_e : /1 A or /5 A	7KM2111-1BA00-3AA0	Internet You can find more information on the Internet at: http://www.siemens.com/powermanagementsystem
7KM PAC3200 measuring device Control panel instrument 96 mm x 96 mm Ring cable lug connections for current and voltage connection AC/DC wide-range power supply unit U_{AUX} : 95 ... 240 V AC \pm 10 %, 50/60 Hz 110 ... 340 V DC \pm 10 % Measuring inputs U_e : max. 3 AC 690/400 V, 50/60 Hz I_e : /1 A or /5 A	7KM2112-0BA00-2AA0	

PROFIBUS SENTRON Measuring Devices

7KM PAC4200 Measuring Devices

Overview



The professional solution for communication and monitoring

The 7KM PAC4200 measuring devices have the same basic properties as the 7KM PAC3200 measuring devices. The device records a total of around 200 measured values, including basic data for assessing the system quality. Furthermore it has convenient additional functions such as user-defined displays, internal device memory, integral time-of-day and calendar function and gateway function.

Benefits

- Simple mounting and commissioning
- High IP65 degree of protection (front side, when installed) permits use in extremely dusty and wet environments
- Intuitive operation via 4 function buttons and multilingual plain text displays
- Easy adaptation to different systems using integrated and optional
 - Digital inputs and outputs
 - Communication interfaces
- Worldwide use
 - Min. 8 languages
 - International approvals
 - Developed and tested to European and international standards
- Low mounting depth

Additional performance characteristics of the 7KM PAC4200:

- Precise energy recording
- Versatile system integration
 - Integrated Ethernet interface
 - Optional communication modules available
 - Multifunctional digital inputs and outputs
 - Limit monitoring
- Can be directly connected to power supply networks up to 690 V AC (UL-L), CATIII without voltage transformer (with the exception of devices with power supply units with extra-low voltage)
- Easy-to-use configuration software powerconfig included in the scope of delivery
- Monitoring of plant status and network quality
 - Basic information for evaluating network quality
 - Logging of plant operations through operational, operating and system events
- Recording of the power range through power averaging (load profile)
- Daily energy meters for apparent, active and reactive energy across 365 days for cut-off date assessment
- Detection of gas, water, compressed air or other energy sources via pulse counter to the digital inputs
- Can be expanded using modules to up to 10 digital inputs and 6 digital outputs
- Counters for apparent, active and reactive energy for the precise detection of the power consumption of a partial process or manufacturing process
- 10/100 Mbit/s Ethernet interface with gateway function for the easy connection of devices with serial RS485 interface via expansion module 7KM PAC RS485 to an Ethernet network
- Comprehensive convenience indicators, such as user-defined displays, bar and status indicators, phase diagram and list and histogram graphics
- Satisfies the accuracy requirements of class 0.2S high-precision utility meters according to IEC 62053-22, which are normally reserved for exacting industrial applications

Ordering data	Article No.	More information
7KM PAC4200 measuring device Control panel instrument 96 mm x 96 mm screw connections for current and voltage connection AC/DC wide-range power supply unit U_{AUX} : 95 ... 240 V AC \pm 10 %, 50/60 Hz 110 ... 340 V DC \pm 10 % Measuring inputs U_e : max. 3 AC 690/400 V, 50/60 Hz I_e : /1 A or /5 A	7KM4212-0BA00-3AA0	Accessories For accessories, see Catalog LV 10 Current transformers Suitable current transformers can be found in the Catalog LV 10 under "Molded case circuit breakers" Manual The manual / operating instructions for 7KM PAC4200 measuring devices can be found on the Internet at http://support.automation.siemens.com/WW/view/en/31675630/133300
7KM PAC4200 measuring device Control panel instrument 96 mm x 96 mm screw connections for current and voltage connection DC extra-low voltage power supply unit U_{AUX} : 22 ... 65 V DC \pm 10 % Measuring inputs U_e : max. 3 AC 500/289 V, 50/60 Hz I_e : /1 A or /5 A	7KM4211-1BA00-3AA0	Internet You can find more information on the Internet at: http://www.siemens.com/lowvoltage/powermonitoring
7KM PAC4200 measuring device Control panel instrument 96 mm x 96 mm Ring cable lug connections for current and voltage connection AC/DC wide-range power supply unit U_{AUX} : 95 ... 240 V AC \pm 10 %, 50/60 Hz 110 ... 340 V DC \pm 10 % Measuring inputs U_e : max. 3 AC 690/400 V, 50/60 Hz I_e : /1 A or /5 A	7KM4212-0BA00-2AA0	

PROFIBUS SENTRON Measuring Devices

7KM PAC Switched Ethernet PROFINET Expansion Module

Overview

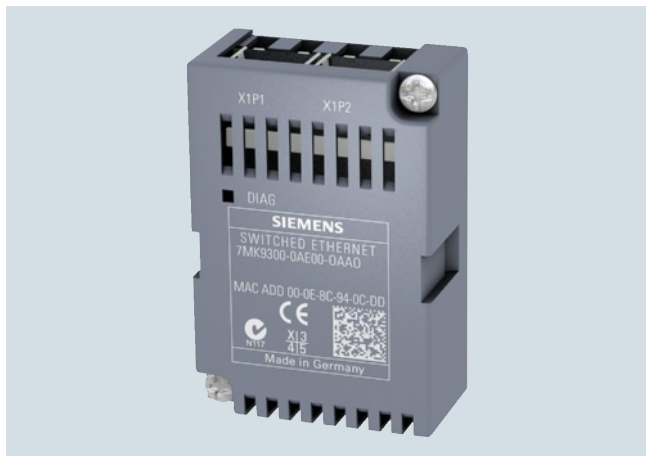

7KM PAC Switched Ethernet expansion module

The 7KM PAC Switched Ethernet PROFINET expansion module is a plug-in communication module for 7KM PAC3200 and 7KM PAC4200 measuring devices.

It provides the following features:

- Standardized PROFlenergy interface to the measured quantities.
- The measured quantities can be individually selected using a GSDML file. This permits use of cost-effective S7 CPUs.
- Easy parameter assignment using the device display and STEP 7.
- Integrated Ethernet switching allows networking with short cables without additional switches.
- Direct integration in production machine networks using IRT (IRT = Isochronous-Real-Time).
- Full support of PROFINET IO (DHC, DNS, SNMP, SNTIP).
- Device replacement without PG in the PROFINET assembly using LLDP.
- Deterministic reversing time through ring redundancy (MRP).
- Modbus TCP communication
- Communication with powermanager or powerconfig
- 2 x Ethernet (RJ45) sockets.
- Baud rates 10 and 100 Mbit/s.
- Protocols PROFINET IO, PROFlenergy and Modbus TCP.
- No external auxiliary power necessary
- Additional display via the device display and via LEDs on the module

All measured quantities from 7KM PAC3200 and 7KM PAC4200 can be individually selected and cyclically transmitted by means of the GSDML file. This enables optimum use of the process image of the PROFINET controller, e. g. CPU 315-2 PN/DP of SIMATIC S7.

The measured quantities can be read out in acyclic mode using PROFlenergy, a PNO protocol profile. Thanks to PROFlenergy, it is possible to assemble a power monitoring system with devices from various manufacturers using PROFINET.

Ordering data

7KM PAC Switched Ethernet PROFINET expansion module

Expansion module for 7KM PAC3200 and 7KM PAC4200 (PROFlenergy)

Article No.

7KM9300-0AE01-0AA0

Overview



PAC PROFIBUS DP expansion module for SENTRON PAC3200 Power Monitoring Device

The 7KM PAC PROFIBUS DP expansion module offers the following features:

- The 7KM PAC PROFIBUS DP expansion module offers the following features:
- Plug-in communication module for measuring devices for connection to PROFIBUS DPV1
- 7KM PAC3200 and 7KM PAC4200
- Can be configured locally via the front of the device or using parameterization software
- Using PROFIBUS DPV1, data can be transferred in both cyclic and acyclic modes
- Easy engineering thanks to integration in SIMATIC STEP 7 and/or simple integration via GSD file for other programming systems
- Optimum use of process image of a control system for selection of individual measured quantities for cyclical transfer
- Supports all baud rates from 9.6 kbit/s up to 12 Mbit/s
- Connection through 9-pole Sub-D connector according to IEC 61158
- No external auxiliary power necessary
- Additional display via the device display and via LEDs on the module

Ordering data

Article No.

7KM PAC PROFIBUS DP expansion module

Expansion module for 7KM PAC3200 and 7KM PAC4200 (PROFIBUS DPV1)

7KM9300-0AB01-0AA0

PROFIBUS SENTRON Measuring Devices

7KM PAC RS485 Expansion Module

Overview



PAC RS485 expansion module for SENTRON PAC3200
Power Monitoring Device

The 7KM PAC RS485 expansion module offers the following features:

- Plug-in 7KM PAC RS485 communication module for 7KM PAC3200 and 7KM PAC4200 measuring devices
- Can be configured locally from the front of the device or using parameterization software
- Supports the Modbus RTU protocol
- Plug and play
- Supports baud rates 4.8 / 9.6 / 19.2 and 38.4 kbit/s.
- Connection by means of 6-pole screw terminals
- No external auxiliary power necessary
- Status indication via LED on the module
- The 7KM PAC RS485 expansion module is required for the gateway function of the 7KM PAC4200 for communication with simple devices with RS485 interface, such as the 7KM PAC3100, via Ethernet (Modbus TCP).

Ordering data

7KM PAC RS485 expansion module

Expansion module for
7KM PAC3200 and
7KM PAC4200
(Modbus RTU)

Article No.

7KM9300-0AM00-0AA0

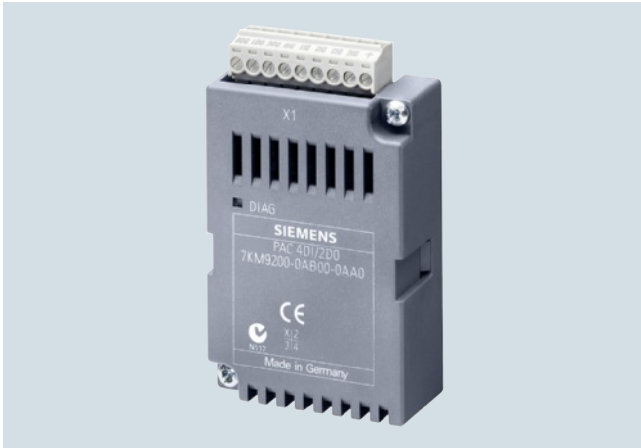
Overview

SENTRON PAC 4DI/2DO expansion module

The 7KM PAC 4DI/2DO expansion module is used to expand the 7KM PAC4200 measuring device to up to 10 digital inputs and 6 digital outputs and offers the following features.

- Up to two 7KM PAC 4DI/2DO modules can be plugged onto a 7KM PAC4200.
- The 7KM PAC 4DI/2DO expansion modules mean that the internal digital inputs and outputs can be expanded by up to 8 inputs and 4 outputs.
- The 7KM PAC 4DI/2DO expansion modules can be configured locally at the front of the device or via the powerconfig parameterization software.
- The digital inputs can be used without the need for an external power supply as they are self-powered. This is particularly useful for the integration of non-electric measuring devices, such as water or compressed-air counters.
- All functions of the integrated multifunctional inputs/outputs of the 7KM PAC4200 are also available in the 7KM PAC 4DI/2DO expansion module.
- Inputs and outputs can be used as an S0 interface conforming to IEC 62053-31.
- The connection is made via a 9-pole screw terminal.
- No external auxiliary power supply is required.

Ordering data
Article No.
7KM PAC 4DI/2DO expansion module
7KM9200-0AB00-0AA0

Expansion module for 7KM PAC4200

PROFIBUS

Configuring, Visualizing and Controlling with SIMATIC

Library 7KM PAC3200 for SIMATIC PCS

Overview

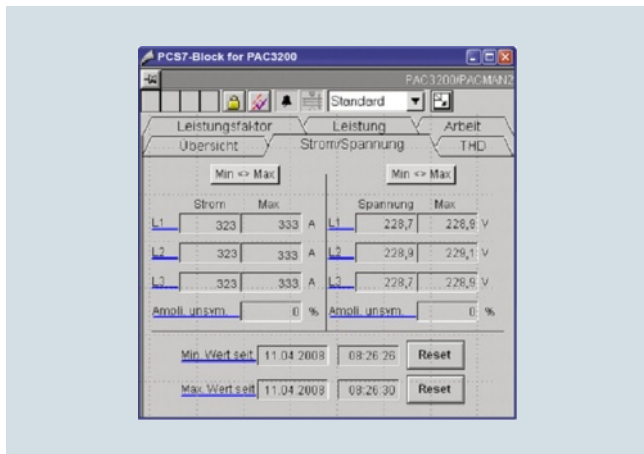

The 7KM PAC3200 for SIMATIC PCS 7 library is a block library for the 7KM PAC3200 and 7KM PAC4200 measuring devices. It allows seamless integration of the measuring devices into the PCS 7 process environment.

The 7KM PAC3200 for SIMATIC PCS 7 library consists of a driver block, a diagnostics block, and the faceplates. The blocks in the SIMATIC S7 supply energy data to the faceplates in the user interface of the process control system, generate signals and guarantee connection to the maintenance system of PCS 7.

Faceplates

Faceplates serve as a user interface for operator control and monitoring and enable technologically important values and functions of the 7KM PAC3200 / 4200 measuring device to be displayed and performed as a PCS 7 object.

On the system side, there are bidirectional communication connections both between the faceplates and the function blocks and between the function blocks and the 7KM PAC3200 / 4200 measuring device. They support the display of values in the faceplates and the forwarding of input data to the device.

This transforms the 7KM PAC3200 / 4200 measuring device into an integral component of PCS 7.

The operating systems supported are the same as those for the SIMATIC PCS 7.

Benefits

- Full integration of 7KM PAC3200/4200 measuring devices in the PCS 7 process control system through PROFIBUS DPV1 using a certified PCS 7 option
- Reading out and displaying device data
- Inputting limit values for monitoring through the driver block
- Resetting of values on the device (min/max values)

Application

The 7KM PAC3200 for SIMATIC PCS 7 library is used in all areas in which PCS 7 is used. Full integration in PCS 7 means that there is no need for a special system environment. Predefined modules and symbols give you the assurance of building on tested and certified product components.

For challenging measurements, the 7KM PAC4200 measuring device can also be used in the functional scope of the 7KM PAC3200.

In addition to the cyclic connection, there is also an acyclic connection for pure visualization tasks. The process image of the SIMATIC CPUs can be used more efficiently with the acyclic connection.

Ordering data

Article No.

Library 7KM PAC3200 for SIMATIC PCS 7¹⁾

Engineering license

- For operation on one PCS 7 OS (single workstation system or server) and an automation system (AS).
- When using additional PCS 7 OS devices, you need an engineering license for each PCS 7 OS.

3ZS2781-1CC11-0YG0

Runtime license

- For operation on an additional AS

3ZS2781-1CC10-6YH0

¹⁾ Can also be used for 7KM PAC4200
For currently supported SIMATIC PCS 7 versions see <http://support.automation.siemens.com>

Overview

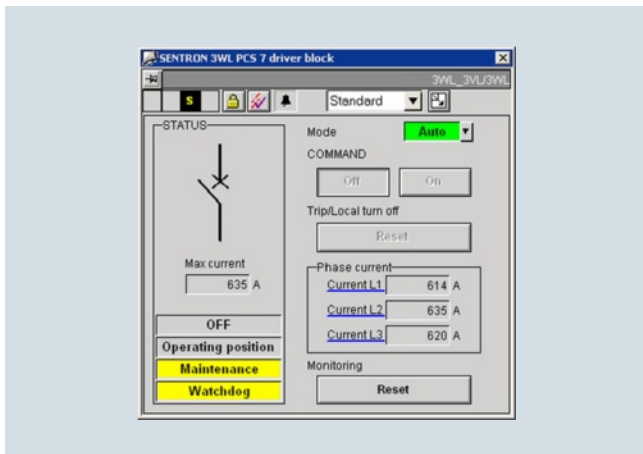

The 3WL / 3VL for SIMATIC PCS 7 library is a block library for the 3WL and 3VL circuit breakers. It allows seamless integration of the circuit breakers into the PCS 7 process environment.

The 3WL / 3VL for SIMATIC PCS 7 library consists of a driver block, a diagnostics block, and the faceplates. The blocks in the SIMATIC S7 supply current, power and energy data to the faceplates in the user interface of the process control system, generate signals and ensure connection to the PCS 7 maintenance system.

Faceplates

Faceplates serve as a user interface for operating and monitoring and make it easy for the circuit breaker to be displayed and operated as a PCS 7 object.

The 3WL / 3VL for SIMATIC PCS 7 library provides for continual plant transparency. Critical plant states are recognized quickly and costs due to outages avoided. System availability is permanently increased.

This transforms the circuit breaker into an integral component of PCS 7.

The operating systems supported are the same as those for the SIMATIC PCS 7.

Benefits

- Full integration of the 3WL/3VL circuit breaker into the PCS 7 process control system through PROFIBUS DPV1 using a certified PCS 7 option
- Remote switching and monitoring
- Read-out of maintenance information
- Automatic information in case of overload, short circuit and faults
- Reading out and displaying device data
- Limit value monitoring by the driver block
- Resetting of values on the device (min/max values)

Application

The 3WL/3VL for SIMATIC PCS 7 library is used in all areas in which PCS 7 is used. Full integration in PCS 7 means that there is no need for a special system environment. Predefined modules and symbols give you the assurance of building on tested and certified product components.

PROFIBUS

Configuring, Visualizing and Controlling with SIMATIC

Library 7KM PAC3200 for SIMATIC WinCC

Overview

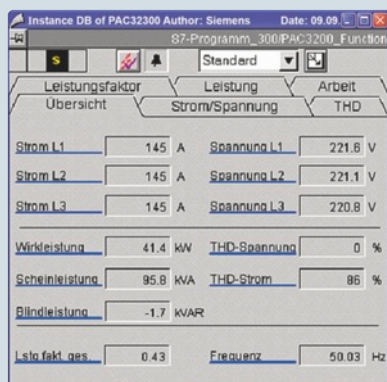

The 7KM PAC3200 for SIMATIC WinCC library is a block library for the 7KM PAC3200 and 7KM PAC4200 measuring devices. It allows seamless integration of the measuring devices into WinCC.

The 7KM PAC3200 for SIMATIC WinCC library consists of a driver block, a diagnostics block, and the faceplates. The blocks in the SIMATIC S7 supply energy data to the faceplates in the WinCC user interface, generate signals and ensure connection to the WinCC signaling system.

Faceplates

Faceplates serve as a user interface for operating and monitoring and enable technologically important values and functions of the 7KM PAC3200 / 4200 measuring device to be displayed and performed in WinCC.

On the system side, there are bidirectional communication connections both between the faceplates and the function blocks and between the function blocks and the 7KM PAC3200 / 4200 measuring device. They support the display of values in the faceplates and the forwarding of input data to the device.

This transforms the 7KM PAC3200 / 4200 measuring devices into an integral component of WinCC.

System requirements

The 7KM PAC3200 for SIMATIC WinCC library is released for WinCC V 7.0

WinCC options AS-OS Engineering and Basic Process Control must be installed. The function block library is available for S7-300, S7-400 and WinAC RTX.

At least one S7 CPU317-2DP is required for use in the S7-300 area. At least one S7 CPU414-2 is required for use in the S7-400 area.

The operating systems supported are the same as those for SIMATIC WinCC.

Benefits

- Full integration of the 7KM PAC3200/4200 measuring devices in SIMATIC WinCC through PROFIBUS DPV1. The library is a certified WinCC option.
- Reading out and displaying device data
- Inputting limit values for monitoring through the driver block
- Resetting of values on the device (min/max values)

Application

The 7KM PAC3200 for SIMATIC WinCC library is used in all areas in which WinCC is used. Predefined function blocks and symbols give you the assurance of building on tested and certified product components.

In addition to the cyclic connection, there is also an acyclic connection for pure visualization tasks. The process image of the SIMATIC CPUs can be used more efficiently with the acyclic connection.

Ordering data

Article No.

Library 7KM PAC3200 for SIMATIC WinCC ¹⁾

Engineering license

- For operation on one WinCC OS (single workstation system or server) and an automation system (AS).
- When using additional WinCC OS devices, you need an engineering license for each WinCC OS.

3ZS2791-1CC11-0YGO

Runtime license

- For operation on an additional AS

3ZS2791-1CC10-6YH0

¹⁾ Can also be used for 7KM PAC4200
For currently supported SIMATIC WinCC versions see <http://support.automation.siemens.com>

Overview



powermanager: Power monitoring made easy

With the PC-based powermanager power monitoring software and the measuring devices of the SENTRON family, Siemens offers an ideal solution for power monitoring in non-residential buildings or smaller and medium-sized industrial plants. Energy costs are reduced and energy availability is increased – with a minimum initial investment and full expandability!

The powermanager records energy and power values as well as electrical parameters such as current, voltage or power factor (cos phi). It is possible not just to display the values, but also to monitor and archive them to perform analyses at a later time. To optimize power demand, this data can be displayed and then compared in the form of a load curve. Quick consumption analyses are possible by means of the supplied cost center reports or by means of freely structured reports according to individual requirements.

The advantages at a glance

- Low engineering overhead thanks to extensive default settings in the software
- High cost-effectiveness even for small systems thanks to low initial investment
- Direct access also possible over the web
- Comprehensive functions already included in the basic package, e.g. reporting
- Customer-specific adjustments and expansions possible at any time by means of option packages
- Identification of possible optimization and potential savings thanks to transparency in the power distribution
- Important module for power management systems, e.g. when designed according to the new EN 16001 standard
- Price advantage through favorably priced system packages comprising software and hardware

Software functions

- Recording and visualization of measured energy values
- Limit monitoring using freely configurable alarms
- Display of load profile or any other measured variables as a characteristic curve
- Predefined reports for the allocation of consumption and the resulting costs to any cost centers
- Freely configurable reports based on Excel
- Monitoring of circuit breaker statuses
- Preconfigured project settings enable you to get started easily

Benefits

- Transparency of power flows
- Exact knowledge of the consumption profile
- Increased power efficiency
- Optimization of power supply contracts
- Compliance with contractual terms
- Allocation of power costs to cost centers
- Optimization of plant maintenance
- Identification of critical plant conditions
- Available languages: German, English, Spanish, Portuguese
- Support of the various device communication interfaces (Modbus RTU, Modbus TCP)
- Status display of devices

Application

Application

The product offers a standard power monitoring solution which provides the user with the following basic functions:

- Collection of measured quantities from the devices
- Presentation of the measured quantities from the devices in a predefined standard view for the 7KT PAC1500, 7KM PAC3100, 7KM PAC3200, 7KM PAC4200 measuring devices and 3WL/3VL circuit breakers
- Free presentation of measured quantities possible, including from non-Siemens devices, using generic Modbus drivers
- Archiving of measured quantities
- Monitoring of status and limits, with generation of corresponding signals
- Load curve display for visualizing the archived data and online data
- Cost center reports based on predefined rates and the archived consumption data
- OPC server
- Configuration of the system including user management
- Load monitoring for complying with power limits
- Virtual computation

This standard solution is designed with cost-efficiency and simple system start-up in mind.

PROFIBUS

Configuring, Visualizing and Controlling with SENTRON

powermanager

Application (continued)

3

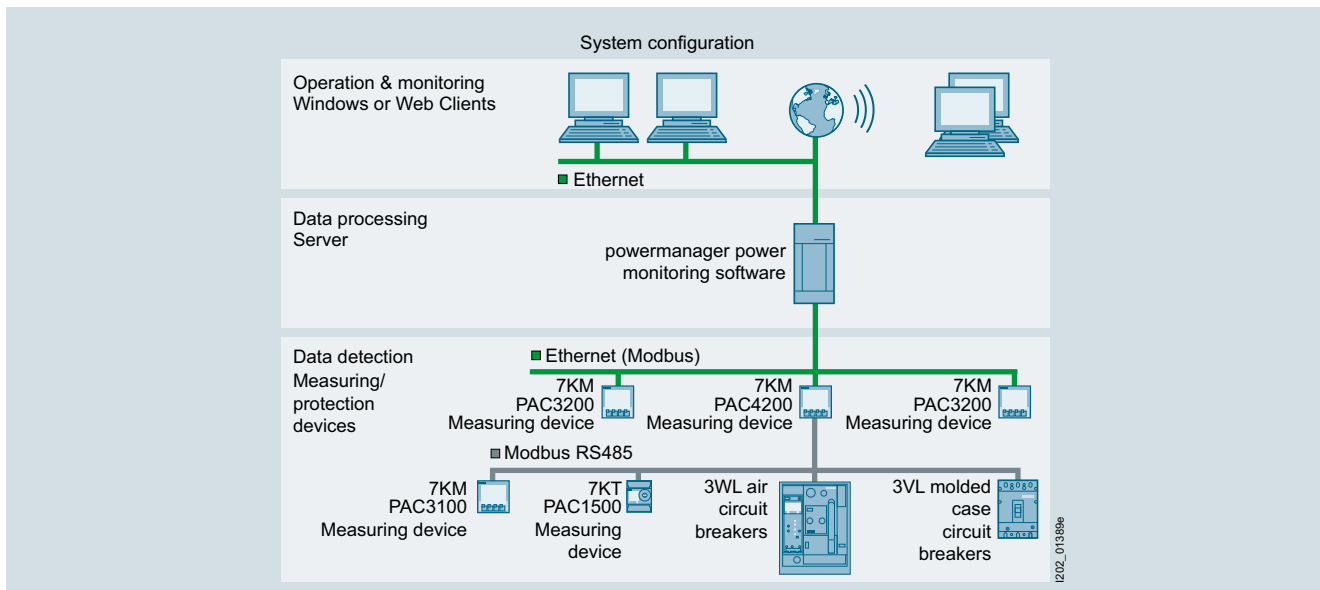

Topology of the power monitoring system with powermanager

Structure of a distributed system

Cross-site networking is possible with the "Distributed Systems" functionality:

- Linking of several autonomous SENTRON powermanager systems

- Each system can access and display measured variables and alarms of other systems.
- Cross-system report generation
- Increase in the maximum number of devices thanks to load distribution.

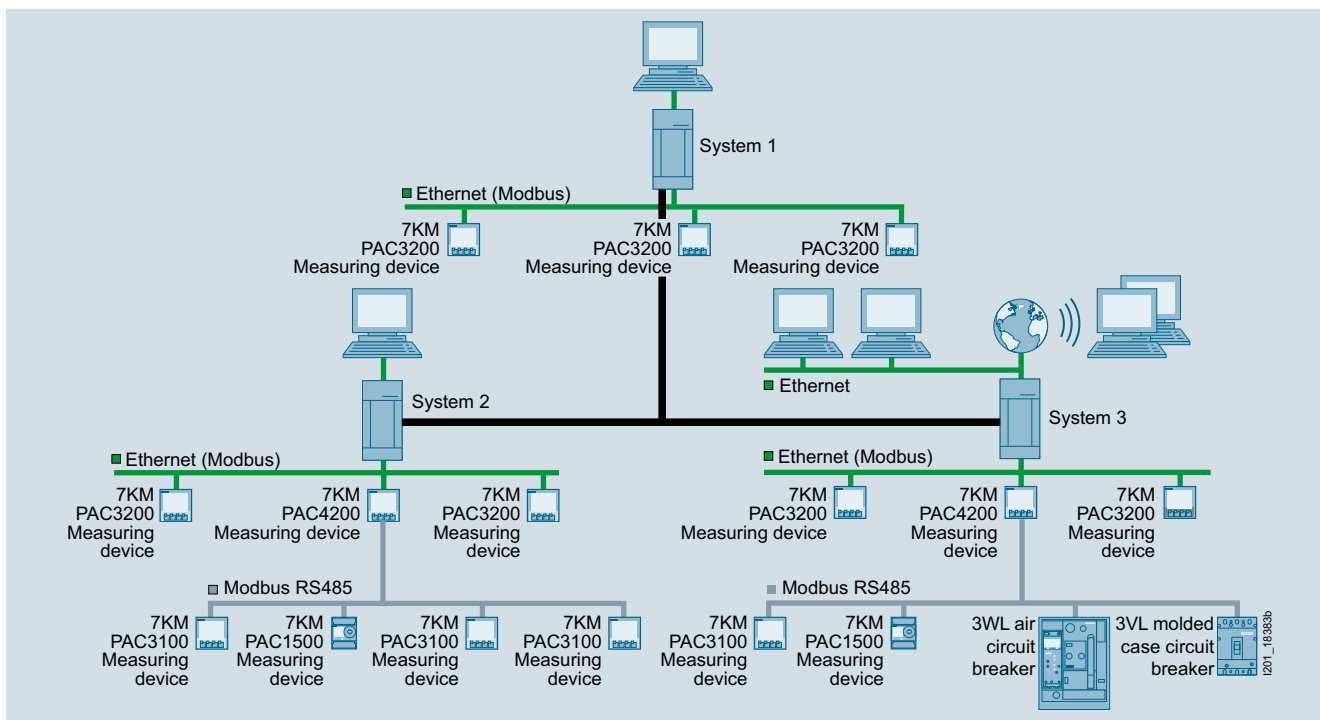

Topology of a distributed power monitoring system with powermanager system packages

Ordering data	Article No.	Article No.
powermanager V 3.0 <ul style="list-style-type: none"> • Trial license Up to 10 devices inc. "Expert" and "Web" option packs Full product license limited to 30 days • Basic package Full product license up to 10 devices, installation for client/server • Device pack (20) Device expansion license for up to 20 devices • Device pack (50) Device expansion license for up to 50 devices • Device pack (100) Device expansion license for up to 100 devices • Device pack (200) Device expansion license for up to 200 devices • Device pack (500) Device expansion license for up to 500 devices • Device pack (1 000) Device expansion license for up to 1 000 devices • Update license From V2.0 Lean to V3.0 (10) • Update license From V 2.0 Standard to V 3.0 (50) • Update license From V 2.0 Advanced to V 3.0 (100) • Update license From V 2.0 Maximum to V 3.0 (200) 	3ZS2711-0CC30-0YA7 3ZS2711-0CC30-0YA0 3ZS2711-0CC30-0YD0 3ZS2712-0CC30-0YD0 3ZS2713-0CC30-0YD0 3ZS2714-0CC30-0YD0 3ZS2715-0CC30-0YD0 3ZS2716-0CC30-0YD0 3ZS2711-0CC30-0YE0 3ZS2712-0CC30-0YE0 3ZS2713-0CC30-0YE0 3ZS2714-0CC30-0YE0	Option packs <ul style="list-style-type: none"> • Option pack "Expert" Option for creating/presenting any number of freely configured images • Option pack "Web" Option for access via the Web (e.g. Internet Explorer) for up to 10 clients • Option pack "Client (5)" Expansion for up to 5 clients • Option pack "Distributed Systems (2)" Option for the connection of 2 autonomous powermanager systems For the exchange of measured values and alarms • Option pack "Distributed Systems (5)" Option for the connection of 5 autonomous powermanager systems For the exchange of measured values and alarms • Option pack "Distributed Systems (10)" Option for the connection of 10 autonomous powermanager systems For the exchange of measured values and alarms
powermanager V 2.0 <ul style="list-style-type: none"> • Upgrade license From Lean to Standard • Upgrade license from Standard to Advanced • Upgrade license from Advanced to Maximum 	3ZS2712-0CC20-0YD0 3ZS2713-0CC20-0YD0 3ZS2714-0CC20-0YD0	System packages <p>System 1 Package comprising</p> <ul style="list-style-type: none"> • 1 x powermanager V3.0 Basic Package • 1 x 7KM PAC4200 (+RS 485 module) and • 1 x 7KM PAC3100 <p>System 2 Package comprising</p> <ul style="list-style-type: none"> • 1 x powermanager V3.0 Basic Package • 1 x 7KM PAC4200 (+RS 485 module) and • 1 x 7KT PAC1500 (+Modbus module) <p>System 3 Package comprising</p> <ul style="list-style-type: none"> • 1 x powermanager V3.0 Basic Package • 3 x 7KM PAC 3200
		3ZS2710-2CC20-0YH0 3ZS2710-1CC20-0YH0 3ZS2710-3CC00-0YD0 3ZS2718-1CC00-0YH0 3ZS2718-2CC00-0YH0 3ZS2718-3CC00-0YH0 3ZS2812-5CC20-0AY0 3ZS2812-6CC20-0YA0 3ZS2813-2CC20-0YA0

PROFIBUS

Configuring, Visualizing and Controlling with SENTRON

powermanager

More information

System configuration

- Integration of measuring devices by means of predefined device templates for the 7KT/7KM PAC measuring devices and the 3WL/3VL circuit breakers
- Easy integration of already existing modbus-enabled measuring devices
- Communication through Standard Ethernet
- Integration of devices with RS485 interface (ModbusRTU) through Modbus gateway, e.g. the 7KM PAC4200 can be used as the gateway

System packages

The powermanager system packages enable simple and low-cost entry to power monitoring systems. At the same time, the system offers a sound basis for additional expansion with a host of 7KM/7KT PAC measuring devices and/or other expanded versions of powermanager.

The following system packages are available:

- powermanager System 1 for applications in infrastructure, comprising:
 - powermanager V3.0 Basic (3ZS2711-0CC30-0YA0)
 - 7KM PAC4200 (7KM4212-0BA00-3AA0)
 - 7KM PAC3100 (7KM3133-0BA00-3AA0)
 - 7KM PAC RS485 (7KM9300-0AM00-0AA0)
- powermanager System 2 for applications in buildings, comprising:
 - powermanager V3.0 Basic (3ZS2711-0CC30-0YA0)
 - 7KM PAC4200 (7KM4212-0BA00-3AA0)
 - 7KT PAC1500 (7KT1540)
 - 7KM PAC RS485 (7KM9300-0AM00-0AA0)
 - 7KT PAC RS485 (7KT1907)
- System 3 for applications in industry, comprising:
 - powermanager V3.0 Basic (3ZS2711-0CC30-0YA0)
 - 3x 7KM PAC3200 (7KM2112-0BA00-3AA0)

Industries

The energy efficiency that can be achieved through power management with consistent power monitoring and the derived optimization measures is crucial for all industries, e. g. in the manufacturing industry, in non-residential buildings, in the field of services, and in infrastructure projects. This has a particular impact on competitiveness, especially in view of rising energy prices.

System requirements

Hardware requirements

- Processor: Intel core 2 (or better)
- RAM: at least 2 GB
- Hard disk: min. 10 GB free
- Graphics: VGA with at least 1280 x 1024 pixels and 16-bit color intensity

Supported operating systems

- Windows XP: XP with SP3 (32 bit)
- Windows 2003: Professional SP3 (32 bit)
- Windows 7: Professional (32/64 bit)
- Windows Server 2008: Enterprise SP2 (32/64 bit)

Supported Excel versions (required for reporting)

- Excel 2003, Excel 2007, Excel 2010 (32 bit)

Internet

For a free download for powermanager V 3.0 trial license go to <http://support.automation.siemens.com/WWW/view/en/64850998>

For more information, go to

www.siemens.com/powermanager

TÜV Certificate of Conformity ISO 50001

The TÜV Certificate of Conformity ensures that the 7KM/KT PAC measuring devices, the 3VL molded case circuit breaker, the 3WL air circuit breaker and the powermanager power monitoring software support the introduction of an operational power management system in accordance with ISO 50001. The ISO 50001 energy saving standard defines binding criteria for companies for sustainable energy management.



TÜV Rhineland Certificate for SENTRON powermanager

The TÜV Certificate is available at

<http://w3.siemens.com/powerdistribution/global/EN/lv/product-portfolio/software/software-sentron/powermanager/tuev-tested-quality/Documents/certificate-of-conformity-110267.pdf>

Overview

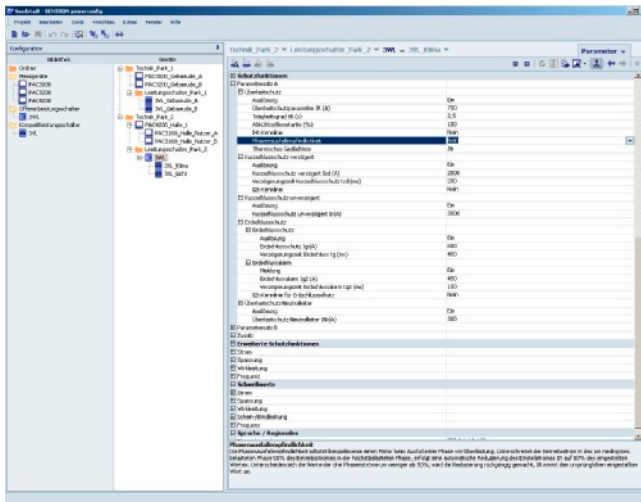

powerconfig

The powerconfig software is the new combined commissioning and service tool for communication-capable measuring devices and circuit breakers from the SENTRON portfolio.

The PC-based tool makes the parameterization of the devices easier, which gives rise to a considerable time saving, particularly when several devices have to be set up.

With powerconfig, the 3WL and 3VL circuit breakers and the 7KM PAC measuring devices with expansion modules can be parameterized, documented, operated and monitored using various communication interfaces.

Benefits

- Parameterization, documentation, operation and monitoring in one software
- Documentation of measured values and settings
- Clear presentation of the available parameters including plausibility testing of the inputs
- Display of the available device statuses and measured values in standardized views
- Project-oriented storage of device data
- Consistent operation and usability
- Support of the various device communication interfaces (Modbus RTU, Modbus TCP)
- Supported languages: English and German
- Read-out and saving of device recordings (device-dependent)
- Update of the device firmware and loading of language packs (device-dependent)
- No programming knowledge required for operation
- Communication via PROFIBUS and PROFINET and connection to STEP7 (in preparation)

Benefits

- Parameterization, documentation, operation and monitoring in one software
- Documentation of measured values and settings
- Clear presentation of the available parameters including plausibility testing of the inputs
- Display of the available device statuses and measured values in standardized views
- Project-oriented storage of device data
- Uniform operation and usability support for the various device communication interfaces (Modbus RTU, Modbus TCP, PROFIBUS, PROFINET)
- Supported languages: English and German
- Read-out and saving of message lists, load profiles, and histories (device-dependent)
- Overview of the circuit breaker statuses with currents and events
- Individually selectable plant documentation
- Update of the device firmware and loading of language packs (device-dependent)
- No programming knowledge required for operation
- Call-up of powerconfig from STEP7 V5.5 SP1 and higher, and communication with devices via PROFIBUS/PROFINET

Application

System requirements

Hardware requirements

- Processor: Intel Pentium III, 1 GHz (or better)
- RAM: at least 512 MB
- Hard disk drive: at least 1 GB free
- Color monitor with a minimum resolution of 1 024 x 768 pixels

Supported operating systems

- Windows XP: XP with SP3 (32 bit)
- Windows 7 Professional SP1 (32 bit, 64 bit)
- Windows 7 Ultimate SP1 (32 bit, 64 bit)
- Windows 2008 Server (32 bit)

Required framework

- Microsoft .NET-Framework in accordance with Readme file

PROFIBUS

Configuring, Visualizing and Controlling with SENTRON

powerconfig

Ordering data**Article No.****Library 3WL/3VL for SIMATIC PCS 7¹⁾****Engineering license**

- For operation on one PCS 7 OS (single workstation system or server) and an automation system (AS).
- When using additional PCS 7 OS devices, you need an engineering license each PCS 7 OS.

3ZS2782-1CC10-0YG0**Runtime license**

- For operation on an additional AS

3ZS2782-1CC10-6YH0

¹⁾ Can also be used for 7KM PAC4200
For currently supported SIMATIC PCS 7 versions see
<http://support.automation.siemens.com>

More information

powerconfig is available free of charge at

<http://support.automation.siemens.com/WW/view/en/63452759>

You can find more information on the Internet at:

<http://www.siemens.com/sentron>

Overview

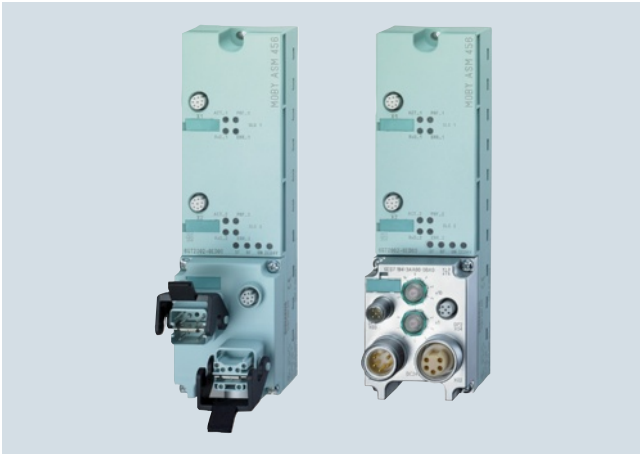

ASM 456 communication module, SIMATIC RF160C

The cost-efficient ASM 456 and SIMATIC RF160C communication modules are stand-alone PROFIBUS DP slaves used to operate the RFID systems MOBY D/U and SIMATIC RF200 / RF300 / RF600 as well as the MV400 code reading systems via PROFIBUS DP:

- SIMATIC S7 (including FB/FC software)
- SINUMERIK
- PC, IPC, non-Siemens PLC
- SIMOTION (with integrated software library)

Thanks to their high degree of protection and ruggedness, they are particularly suitable for machine-level use. The modular structure with different PROFIBUS connection systems allows them to be used in all applications. The uniform plug-in connection system ensures rapid commissioning.

Benefits

get Designed for Industry

- Two parallel MOBY channels ensure real-time mode at dynamic read points.
- Modular design with different bus interfacing possibilities ensures universal implementation.
- Reader connection using an 8-pin M12 connector for quick mounting of all components.
- High-performance hardware ensures fast data exchange with the reader. Consequently, data is available for the application even faster.
- Very easy downloading of firmware via the SIMATIC MANAGER for function expansions and error rectification ensure high availability of the identification system.
- The parameterizable identification-system-specific PROFIBUS diagnostics facilitate start-up and troubleshooting.
- A wide selection of pre-assembled PROFIBUS connecting cables can be ordered for the communication modules. This saves time and money during installation and assures better quality.

Application

The ASM 456 and SIMATIC RF160C communication modules have been specifically designed for a wide range of applications in industrial automation and logistics. Thanks to the high IP67 degree of protection, the ASM 456 and RF160C can be installed in the process without a control cabinet.

Main application areas for ASM 456 and RF160C:

- Mechanical engineering, automation systems, conveyor systems
- Ancillary assembly lines in the automobile industry/suppliers
- Small assembly lines
- Production, packaging, textile, plastics and printing machines SIMOTION

Design

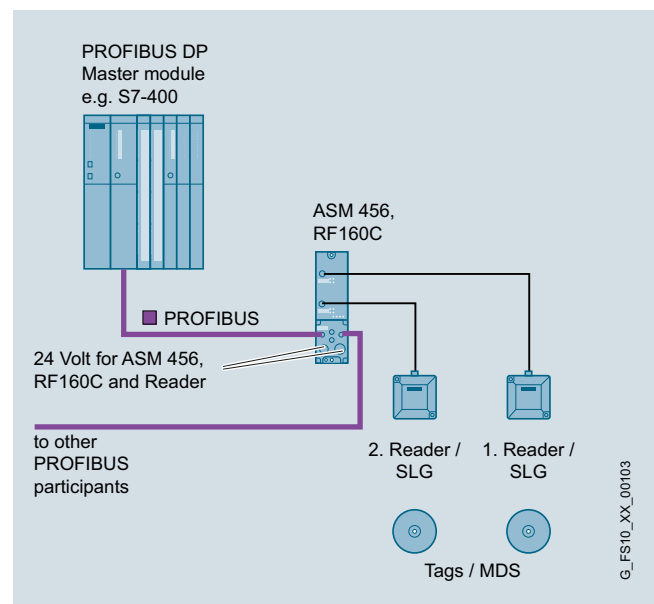

PROFIBUS

Industrial Identification Systems

ASM 456, SIMATIC RF160C

Function

The ASM 456 and the RF160C comprise a basic module and a connection block that must be ordered separately. When connecting PROFIBUS, the customer can choose between ECOFAST connections and M12, 7/8" connections.

A pre-assembled reader cable is used to connect one or two readers/SLGs to the communication module. The standard length of the cable is 2 m. If other cable lengths to the reader are required, an extension cable measuring between 2 m and 50 m can be used. The cable can also be assembled by the customer as required.

The PROFIBUS DP procedure according to EN 50170 Vol. 2 PROFIBUS for communication between the communication module and SIMATIC S7 (or any PROFIBUS master) and the MOBY-specific procedures for communication between ASM and reader are implemented on the communication modules.

The data in the transponder can be accessed as follows:

- Direct addressing via absolute addresses
- Conveniently via the MOBY file handler (MOBY U, RF300 only) using file names (for ASM 456 only)

On the PROFIBUS DP, the communication module occupies a node address on the bus that is set on the connection block. The communication module is integrated into the hardware configuration by means of a device master (GSD) file. Then the communication module can be configured by means of the software tool HW_Config of the SIMATIC Manager or another PROFIBUS tool.

Error messages and operating states (MDS in the field, transmission, etc.) are indicated additionally by means of LEDs and simplify commissioning and service.

The ASM 456 and RF160C have two reader interfaces which also provides the readers with power. In the communication module, the power supply of the readers has an electronic fuse.

ASM 456

The ASM directly accesses the data in the transponder or in the data matrix code by means of absolute addresses (FB/FC45, FB/FC55) or more conveniently using the MOBY file handler (FC56) and file names. The communication module is operated in non-cyclic mode over PROFIBUS DP V1. Consequently, a very large amount of data can be transferred to/from the communication module without overloading the PROFIBUS cycle. This has advantages when transferring large volumes of data. In addition, the communication module can process concatenated transponder commands very quickly in this mode.

Function blocks FB101/116/132 in the SIMATIC S7 are available for the "RFID standard profile" mode. The data in the transponder can be addressed either via absolute addresses or via the file handler. This mode additionally integrates the communication module in SIMOTION.

SIMATIC RF160C

The data in the transponder is accessed via absolute addresses. The FC44 function block is available for SIMATIC S7 for this purpose. The RF160C is operated in cyclic mode over PROFIBUS DP-V0. This ensures a deterministic response in data communication in every case. Where large volumes of data are transferred in large-scale bus configurations, the data throughput should be tested with a tool which is provided on the DVD "RFID Systems, Software and Documentation". The programming interface to RF160C is extremely easy to use and can be programmed efficiently in any controller. The RF160C is therefore particularly suitable for use with non-Siemens controllers and older PROFIBUS masters.

Technical specifications

Article No.	6GT2002-0ED00	6GT2002-0EF00
Product-type designation	ASM 456 communication module	RF160C communication module
Suitability for installation	PROFIBUS matching DP-V1 in conjunction with RF200/300/600, MOBY D/E/I/U, MV	PROFIBUS matching DP-V0 in conjunction with RF200/300/600, MOBY D/U
Transfer rate with PROFIBUS	9.6 kbit/s ... 12 Mbit/s	9.6 kbit/s ... 12 Mbit/s
Transmission rate at point-to-point connection serial maximum	115.2 kbit/s	115.2 kbit/s
Interfaces		
Design of interface for point-to-point connection	RS422	RS422
Number of readers connectable	2	2
Design of the electrical connection		
• of the PROFIBUS interface	(according to the connection block)	(according to the connection block)
• for supply voltage	(according to the connection block)	(according to the connection block)
Version of the interface to the reader for communication	M12, 8-pin	M12, 8-pin
Mechanical data		
Material	Thermoplastic (Valox 467, fiberglass reinforced)	Thermoplastic (Valox 467, fiberglass reinforced)
Color	IP Basic 714	IP Basic 714
Tightening torque of screw for mounting the equipment maximum	3 N·m	3 N·m

Technical specifications (continued)

Article No.	6GT2002-0ED00	6GT2002-0EF00
Product-type designation	ASM 456 communication module	RF160C communication module
Supply voltage, current consumption, power loss		
Supply voltage for DC		
• rated value	24 V	24 V
• minimum	20 V	20 V
• maximum	30 V	30 V
Current consumed at 24 V with DC		
• without connected devices typical	0.08 A	0.08 A
• including connected devices maximum	0.8 A	0.8 A
Permitted ambient conditions		
Ambient temperature		
• during operating	0 ... 55 °C	0 ... 55 °C
• during storage	-40 ... +70 °C	-40 ... +70 °C
• during transport	-40 ... +70 °C	-40 ... +70 °C
Protection class IP	IP 67	IP 67
Resistance against shock	According to IEC 61131-2	According to IEC 61131-2
Resistance against shock	300 m/s ²	300 m/s ²
Resistance against vibration	100 m/s ²	100 m/s ²
Design, dimensions and weight		
Width	60 mm	60 mm
Height	30 mm	30 mm
Depth	210 mm	210 mm
Net weight	0.21 kg	0.21 kg
Mounting type	2 x M5 screws	2 x M5 screws
Cable length for RS 422 interface maximum	1 000 m	1 000 m
Product properties, functions, components general		
Type of display	4 LEDs per reader connection, 4 LEDs for device status	4 LEDs per reader connection, 4 LEDs for device status
Product function transponder file handler can be addressed	Yes	No
Protocol is supported		
• PROFIBUS DP-V0 protocol	No	Yes
• PROFIBUS DP-V1 protocol	Yes	No
Product functions management, configuration		
Type of parameterization	GSD	GSD
Type of programming	FB 45, FB 55, FC 56, Ident profile (PIB), (FC 45/55 with limited functionality)	FC 44
Type of computer-mediated communication	acyclic communication	Cyclic communication
Standards, specifications, approvals		
Verification of suitability	CE, FCC, cULus	CE, FCC, cULus
Accessories		
Accessories	Connection block for ECOFAST system or M12, 7/8"	Connection block for ECOFAST system or M12, 7/8"

PROFIBUS

Industrial Identification Systems

ASM 456, SIMATIC RF160C

Ordering data	Article No.	Article No.
ASM 456 communication module For connecting 2 readers to PROFIBUS DP-V1.	6GT2002-0ED00	
SIMATIC RF160C communication module For connecting 2 readers to PROFIBUS DP-V0.	6GT2002-0EF00	
<i>Accessory: ECOFAST connection</i>		
ECOFAST connection block	6ES7194-3AA00-0AA0	
PROFIBUS ECOFAST HYBRID plug 180 • With male insert (5-pack) • With female insert (5-pack)	6GK1905-0CA00 6GK1905-0CB00	
PROFIBUS ECOFAST termination plug With terminating resistors.	6GK1905-0DA10	
PROFIBUS ECOFAST hybrid cable, copper Trailing-type cable (PUR casing) with two shielded copper cables for PROFIBUS DP and four copper cores of 1.5 mm ² each.		
Sold by the meter Max. delivery unit 1 000 m, minimum ordering quantity 20 m.	6XV1830-7AH10	
Pre-assembled with ECOFAST male and female connector, fixed length:		
0.5 m	6XV1830-7BH05	
1 m	6XV1830-7BH10	
1.5 m	6XV1830-7BH15	
3 m	6XV1830-7BH30	
5 m	6XV1830-7BH50	
10 m	6XV1830-7BN10	
15 m	6XV1830-7BN15	
20 m	6XV1830-7BN20	
25 m	6XV1830-7BN25	
30 m	6XV1830-7BN30	
35 m	6XV1830-7BN35	
40 m	6XV1830-7BN40	
45 m	6XV1830-7BN45	
50 m	6XV1830-7BN50	
<i>Accessory: M12, 7/8" connection</i>		
M12 connection block, 7/8"		6ES7194-3AA00-0BA0
M12 terminating resistor for PROFIBUS Pack with 5 units, minimum ordering quantity 1 pack.		6GK1905-0EC00
PROFIBUS M12 connecting cable Pre-assembled, with 5-pin M12 connector and socket, max. length 100 m.		
0.3 m		6XV1830-3DE30
0.5 m		6XV1830-3DE50
1 m		6XV1830-3DH10
1.5 m		6XV1830-3DH15
2 m		6XV1830-3DH20
3 m		6XV1830-3DH30
5 m		6XV1830-3DH50
10 m		6XV1830-3DN10
15 m		6XV1830-3DN15
Other special lengths with 90° or 120° cable connection		See http://support.automation.siemens.com/WW/view/en/26999294
7/8" connecting cable Pre-assembled, with 5-pin 7/8" connector and socket, max. length 50 m.		
0.3 m		6XV1822-5BE30
0.5 m		6XV1822-5BE50
1 m		6XV1822-5BH10
1.5 m		6XV1822-5BH15
2 m		6XV1822-5BH20
3 m		6XV1822-5BH30
5 m		6XV1822-5BH50
10 m		6XV1822-5BN10
15 m		6XV1822-5BN15
Other special lengths with 90° or 120° cable connection		See http://support.automation.siemens.com/WW/view/en/26999294
PROFIBUS FC Standard Cable Standard type with special design for quick mounting, 2-core, shielded, sold by the meter; maximum ordering quantity unit 1 000 m, minimum ordering quantity 20 m.		6XV1830-0EH10
PROFIBUS M12 cable connector Pack with 5 units, minimum ordering quantity 1 pack. • With male insert • With female insert		6GK1905-0EA00 6GK1905-0EB00
7/8" cable connector for voltage Pack with 5 units, minimum ordering quantity 1 pack. • With male insert • With female insert		6GK1905-0FA00 6GK1905-0FB00
Sealing caps 7/8" For unused 24 V cable extension, pack of 10, minimum ordering quantity 1 pack.		6ES7194-3JA00-0AA0
Power line 5-core, 5 x 1.5 mm ² , trailing type; sold by the meter; maximum ordering quantity 1 000 m, minimum ordering quantity 20 m.		6XV1830-8AH10

Ordering data	Article No.		Article No.
<p><i>General accessories</i></p> <p>Stainless steel screws for connection blocks</p> <p>Optional screws made of V4A steel for securing the connection blocks on the basic module. For use in wet areas. Pack with 40 units is sufficient for 10 connection blocks.</p>	<p>6GT2090-0VB00</p>	<p><i>Accessories for RFID</i></p> <p>MOBY U reader cable PUR material, CMG approval, suitable for cable carriers.</p> <p>2 m</p> <p>5 m</p> <p>MOBY D reader cable PUR material, CMG approval, suitable for cable carriers, 2 m.</p> <p>Reader cable for SIMATIC RF200 / RF300 / RF600 / MV400 or extension cable MOBY U/D and SIMATIC RF200 / RF300 / RF600 / MV400, PUR material, CMG approval, suitable for cable carriers, straight connector</p> <p>2 m</p> <p>5 m</p> <p>10 m</p> <p>20 m</p> <p>50 m</p> <p>2 m, plug angled at reader</p> <p>5 m, plug angled at reader</p> <p>Sealing caps M12 for unused reader connections Minimum ordering quantity 10 units.</p> <p>DVD "RFID Systems Software & Documentation"</p>	<p>6GT2091-4FH20</p> <p>6GT2091-4FH50</p> <p>6GT2691-4FH20</p> <p>6GT2891-4FH20</p> <p>6GT2891-4FH50</p> <p>6GT2891-4FN10</p> <p>6GT2891-4FN20</p> <p>6GT2891-4FN50</p> <p>6GT2891-4JH20</p> <p>6GT2891-4JH50</p> <p>3RX9802-0AA00</p> <p>6GT2080-2AA20</p>

PROFIBUS

Engineering/Network Management/Diagnostics

SIMATIC PDM

Overview

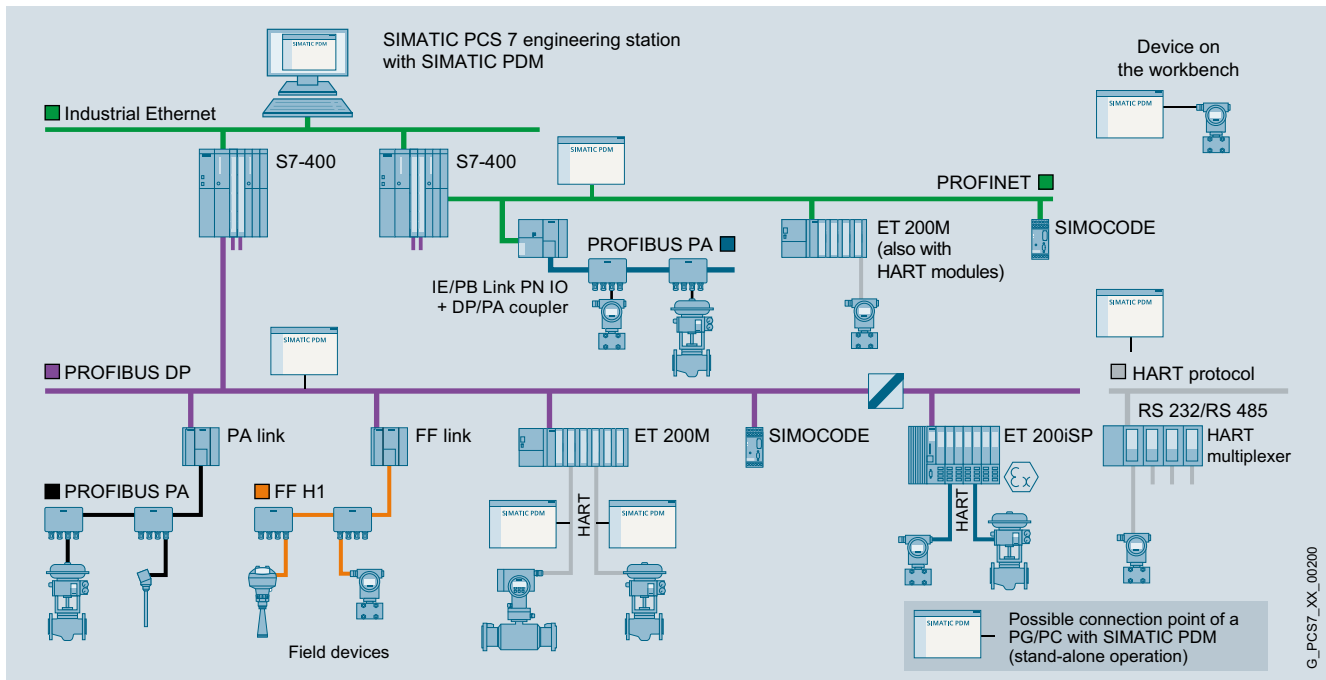

Configuration options with SIMATIC PDM

SIMATIC PDM (Process Device Manager) is a universal, vendor-independent tool for the configuration, parameter assignment, commissioning, diagnostics and servicing of intelligent field devices (sensors and actuators) and field components (remote I/Os, multiplexers, control-room devices, compact controllers), which in the following sections will be referred to simply as devices.

Using *one* software, SIMATIC PDM enables the processing of more than 2 500 devices from Siemens and over 200 vendors worldwide on *one* homogeneous user interface.

The user interface satisfies the requirements of the VDI/VDE GMA 2187 and IEC 65/349/CD directives. Parameters and functions for all supported devices are displayed in a consistent and uniform fashion independent of their communications interface. Even complex devices with several hundred parameters can be represented clearly and processed quickly. Using SIMATIC PDM it is very easy to navigate in highly complex stations such as remote I/Os and even connected field devices.

From the viewpoint of device integration, SIMATIC PDM is the most powerful open device manager available in the world. Devices which previously were not supported can be easily integrated in SIMATIC PDM at any time by importing their device descriptions (EDD). This provides security for your investment and saves you investment costs, training expenses and follow-up costs.

SIMATIC PDM supports the operative system management in particular through:

- Uniform presentation and operation of devices
- Uniform representation of diagnostics information
- Indicators for preventive maintenance and servicing
- Detection of changes in the project and device
- Increasing the operational reliability
- Reducing the investment, operating and maintenance costs
- Forwarding of device information to higher-level Maintenance Stations

When used in SIMATIC PCS 7, SIMATIC PDM is integrated in the asset management of the process control system. You can change directly to the SIMATIC PDM views from the diagnostics faceplates in the Maintenance Station.

The Process Device Manager provides more detailed information for all devices described by means of an Electronic Device Description (EDD), e.g.:

- Detailed diagnostics information (manufacturer information, information on error diagnostics and troubleshooting, further documentation)
- Results of internal condition monitoring functions
- Status information (e.g. local configuration changes)
- Information on changes (audit trail report)
- Parameter information

G_PCS7_XX_00200

Application

Components	Product packages										
	SIMATIC PDM stand-alone						SIMATIC PDM system-integrated				
	Minimum configuration		Basic configuration		Application-specific configurations		SIMATIC PDM S7		SIMATIC PDM PCS 7		
	SIMATIC PDM Single Point	SIMATIC PDM Basic	SIMATIC PDM Basic	SIMATIC PDM Basic	SIMATIC PDM Service	SIMATIC PDM Service	SIMATIC PDM S7	SIMATIC PDM S7	SIMATIC PDM PCS 7	SIMATIC PDM PCS 7	SIMATIC PDM PCS 7
	V6.1	V8.1	V6.1	V8.1	V6.1	V8.1	V6.1	V8.1	V6.1	V8.1	FF V8.1
SIMATIC PDM TAGs ¹⁾ in product package	1	1	4	4	128	100	128	100	128	100	100
SIMATIC PDM expansion options											
TAG options	- 128 TAGs - 512 TAGs - 1 024 TAGs - 2 048 TAGs	<i>cannot be expanded</i>	o	-	-	-	-	-	-	-	-
Power-Packs	- 128 to 512 TAGs - 512 to 1 024 TAGs - 1 024 to 2 048 TAGs - 2 048 to unlimited TAGs		o	-	o	-	o	-	o	-	-
Count Relevant Licenses (accumulative)	- 10 TAGs - 100 TAGs - 1 000 TAGs		-	o	-	o	-	o	-	o	o
SIMATIC PDM Basic			•	•	•	•	•	•	•	•	•
SIMATIC PDM Extended			-	o	-	o	-	•	-	•	•
SIMATIC PDM integration in STEP 7/PCS 7			o	o	o	o	•	•	•	•	•
SIMATIC PDM routing			o	o	o	o	o	o	•	•	•
SIMATIC PDM Communication FOUNDATION Fieldbus			-	o	-	o	-	o	-	o	•
SIMATIC PDM Communication via standard HART multiplexer			o	-	o	-	o	-	o	-	-
SIMATIC PDM HART server			-	o	-	o	-	o	-	o	o
SIMATIC PDM command interface ²⁾			-	o	-	o	-	-	-	-	-

Table with SIMATIC PDM product structure

- Product component is part of the product package
- o Optional product component for the product package, can be purchased separately
- Product component is not relevant or not available for the product package

Customer-oriented product structure

SIMATIC PDM can be implemented in different ways within the framework of Totally Integrated Automation (TIA) - as a stand-alone system or integrated in a SIMATIC PCS 7/SIMATIC S7 configuration environment.

The customer-oriented products structure of SIMATIC PDM helps you to adapt the scope of functions and performance to your individual requirements. You have the following options:

SIMATIC PDM stand-alone

- Product packages for operation on a mobile computer on PROFIBUS or with direct connection to the device, optionally as:
 - Minimal configuration SIMATIC PDM Single Point for processing of a single field device via point-to-point coupling
 - Application-specific configuration SIMATIC PDM Service for extended service tasks
- Product package SIMATIC PDM Basic as the basis for an individual SIMATIC PDM configuration with optional product components (see table)

- 1) For TAG definition, refer to sections "SIMATIC PDM TAGs for SIMATIC PDM V8.1" and "TAG options/PowerPacks for SIMATIC PDM V6.1"
- 2) Only for applications that are not intended for broad-based implementation; programming knowledge is required.

SIMATIC PDM system-integrated

- Product packages for integration of SIMATIC PDM in the engineering system (engineering toolset) and Maintenance Station of the SIMATIC PCS 7 process control system:
 - SIMATIC PDM PCS 7
 - SIMATIC PDM PCS 7-FF (also supports the FOUNDATION Fieldbus H1)
- Product package SIMATIC PDM S7 for integration in a SIMATIC S7 configuration environment

In some circumstances, the various product packages can be expanded with optional product components (for details, see the Design section).

Selection criteria

The current range of solutions comprises products of SIMATIC PDM versions 6.1 and 8.1. SIMATIC PDM V8.1 is supplied with the current service pack. The service pack is, however, not named explicitly in the ordering data and in the textual descriptions.

In addition to considering the environment of use and the functional and performance features (for details, see section "Design"), also observe the different system requirements of these SIMATIC PDM versions when selecting the product (see section "Technical specifications").

PROFIBUS

Engineering/Network Management/Diagnostics

SIMATIC PDM

Design

Function and performance characteristics	SIMATIC PDM Single Point		SIMATIC PDM Basic		SIMATIC PDM Service		SIMATIC PDM S7		SIMATIC PDM PCS 7		
	V6.1	V8.1	V6.1	V8.1	V6.1	V8.1	V6.1	V8.1	V6.1	V8.1	FF V8.1
TAGs contained	1	1	4	4	128	100	128	100	128	100	100
Project: Create online	•	–	•	•	•	•	•	•	•	•	•
Project: Create offline	–	•	•	•	•	•	•	•	•	•	•
Project: Usable TAG extensions	–	–	•	•	•	•	•	•	•	•	•
Project: Network view	–	•	•	•	•	•	•	•	•	•	•
Project: Plant view	–	•	•	•	•	•	•	•	•	•	•
Project: Export/import devices	–	–	•	•	•	•	•	–	•	–	–
Project: HW Config	–	–	o	o	o	o	•	•	•	•	•
Project: Utilization of SIMATIC PDM options	–	–	•	•	•	•	•	•	•	•	•
Project: Integration in STEP 7/PCS 7	–	–	o	o	o	o	•	•	•	•	•
Communication: HART modem	•	•	•	•	•	•	•	–	•	–	–
Communication: HART interface	•	•	•	•	•	•	•	–	•	–	–
Communication: PROFIBUS DP/PA	•	•	•	•	•	•	•	•	•	•	•
Communication: HART over PROFIBUS DP	–	•	–	•	–	•	–	•	–	•	•
Communication: FF H1	–	–	–	o ¹⁾	–	o ¹⁾	–	o	–	o	•
Communication: Modbus	•	•	•	•	•	•	•	–	•	–	–
Communication: SIPART DR	•	–	•	–	•	–	•	–	•	–	–
Communication: SIREC	•	–	•	–	•	–	•	–	•	–	–
Communication: Ethernet	–	•	•	•	•	•	•	–	•	–	–
Communication: PROFINET	–	•	–	•	–	•	–	•	–	•	•
Communication: HART over PROFINET	–	•	–	•	–	•	–	•	–	•	•
Devices: Export/import parameters	•	–	•	o	•	•	•	•	•	•	•
Devices: Comparison of values (online/offline)	•	–	•	o	•	•	•	•	•	•	•
Devices: Comparison of values of two devices	–	–	•	o	•	•	•	•	•	•	•
Devices: Saving parameters	–	•	•	•	•	•	•	•	•	•	•
Devices: Logbook (Audit Trail)	–	–	o	o	•	•	•	•	•	•	•
Devices: Calibration report	–	–	o	o	•	•	•	•	•	•	•
LifeList: Export Scan	–	–	•	o	•	•	•	–	•	–	–
LifeList: Device diagnostics	–	–	o	o	•	•	•	•	•	•	•
LifeList: Define scan area	–	•	o	o	•	o	•	•	•	•	•
LifeList: Save scan	–	–	o	o	•	–	•	–	•	–	–
LifeList: Scan from HW Config	–	–	o	o	o	o	•	•	•	•	•
Communication: S7 routing	–	–	o	o	o	o	o	o	•	•	•
Communication: HART multiplexer	–	–	o	o	o	o	–	o	–	o	o
Communication: Wireless HART	–	–	–	o	o	o	–	o	–	o	o
Function: HART SHC mode (increased communication speed)	–	•	•	•	•	•	•	•	•	•	•
Function: "HART-Long TAG"	–	•	–	•	–	•	–	•	–	•	•

SIMATIC PDM overview of functions and features

- Product component is part of the product package
- o Optional product component for the product package, can be purchased separately
- Product component is not relevant or not available for the product package
- ¹⁾ Not in stand-alone mode

Design (continued)**SIMATIC PDM V8.1 incl. SP1 product range****SIMATIC PDM stand-alone**SIMATIC PDM Single Point V8.1

This minimum configuration with handheld functionality is designed for processing exactly *one* field device via point-to-point coupling. It cannot be expanded with functions or TAG options/PowerPacks. Upgrading to a different product variant, e.g. SIMATIC PDM Basic, or a different product version is also not possible. The device functions are supported as defined in the device description.

The following types of communication are possible:

- PROFIBUS DP/PA
- HART communication (modem, RS 232 and via PROFIBUS/PROFINET)
- Modbus
- Ethernet
- PROFINET

SIMATIC PDM Basic V8.1

Provided the system requirements are met, SIMATIC PDM Basic V8.1 can be used for stand-alone operation on any computers (IPC/notebook) with local connection to bus segments or direct connection to the device. The product package features all the basic functions required for operation and parameter assignment of the devices and is enabled for the following communication modes:

- PROFIBUS DP/PA
- HART communication (modem, RS 232 and via PROFIBUS/PROFINET)
- Modbus
- Ethernet
- PROFINET

As a basic block for individual configuration, SIMATIC PDM Basic V8.1 can be upgraded with all the functional options for SIMATIC PDM V8.1 as well as with cumulative 10, 100 or 1 000 SIMATIC PDM TAGs (quantity option as of SIMATIC PDM V7.0). Without TAG expansion, SIMATIC PDM Basic V8.1 is suitable for projects with up to 4 TAGs.

SIMATIC PDM Service V8.1

This product package based on SIMATIC PDM Basic V8.1 for projects with up to 100 TAGs is intended for mobile use in service.

Similar to SIMATIC PDM Basic V8.1, SIMATIC PDM Service V8.1 can be upgraded with all the functional options for SIMATIC PDM V8.1 as well as with cumulative 10, 100 or 1 000 SIMATIC PDM TAGs.

SIMATIC PDM system-integratedSIMATIC PDM S7 V8.1

Similar to SIMATIC PDM S7 V6.1, SIMATIC PDM S7 V8.1 is also designed for use in a SIMATIC S7 configuration environment, but differs functionally (for details, see the table "Overview of functions and performance for SIMATIC PDM") and due to the number of TAGs it features (100 TAGs included). SIMATIC PDM S7 V8.1 is therefore not a functionally compatible successor to SIMATIC PDM S7 V6.1.

SIMATIC PDM S7 V8.1 requires the installation of STEP 7 V5.5+SP2 (for using PROFINET communication STEP 7 V5.5+SP3). When selecting a product, note that SIMATIC PDM S7 V8.1 is not backwards compatible, and multiple SIMATIC PDM versions cannot be operated simultaneously.

SIMATIC PDM S7 V8.1 can be expanded with the functional options "SIMATIC PDM Routing V8.1" and "SIMATIC PDM Communication FOUNDATION Fieldbus V8.1" and "SIMATIC PDM HART Server V8.1" as well as with cumulative sets of 10, 100 or 1 000 SIMATIC PDM TAGs.

SIMATIC PDM PCS 7 V8.1 and SIMATIC PDM PCS 7-FF V8.1

SIMATIC PDM PCS 7 V8.1 and SIMATIC PDM PCS 7-FF V8.1 focus on functions different from those of SIMATIC PDM PCS 7 V6.1 (for details, see the table "Overview of functions and performance for SIMATIC PDM"). They support projects with "PROFINET" and "FOUNDATION Fieldbus" communication and can be expanded with the functional option "SIMATIC PDM HART Server".

FOUNDATION Fieldbus functionality is already integrated in SIMATIC PDM PCS 7-FF V8.1. SIMATIC PDM PCS 7 V8.1 can be appropriately expanded if required using the option "SIMATIC PDM Communication FOUNDATION Fieldbus".

SIMATIC PDM PCS 7 V8.1 and SIMATIC PDM PCS 7-FF V8.1 are initially provided with 100 TAGs. This quantity can be further cumulatively expanded with sets of 10, 100 or 1 000 SIMATIC PDM TAGs (quantity option with SIMATIC PDM V7.0 or higher).

SIMATIC PDM PCS 7 V8.1 and SIMATIC PDM PCS 7-FF V8.1 are not functionally compatible successors to SIMATIC PDM PCS 7 V6.x, and are not downward-compatible. The two product packages require installation of SIMATIC PCS 7 as of V8.0 (V8.0+SP1 for the use of PROFINET communication).

When selecting a product, note that it is not possible to operate multiple SIMATIC PDM versions at the same time.

PROFIBUS

Engineering/Network Management/Diagnostics

SIMATIC PDM

Design (continued)

Optional product components

SIMATIC PDM Extended V8.1 option

The SIMATIC PDM V8.1 Extended option enables you to unlock other system functions of SIMATIC PDM V8.1 for use, for example:

- Change log
- Calibration report
- Extended information in the Lifest
- Export and import functions
- Print functions
- Document manager
- Comparison function

SIMATIC PDM integration option in STEP 7/PCS 7 V8.1

This option is used for the integration of SIMATIC PDM V8.1 in a SIMATIC S7 or SIMATIC PCS 7 configuration environment. SIMATIC PDM V8.1 can then be started directly from the hardware configurator (HW Config) in STEP 7/SIMATIC PCS 7.

SIMATIC PDM Routing V8.1 option

If SIMATIC PDM V8.1 is used on a central engineering station, the SIMATIC PDM Routing V8.1 option enables handling of every device in the field that can be configured per EDD throughout the plant and across different bus systems and remote I/Os. SIMATIC PDM Routing V8.1 is available for SIMATIC PDM S7 V8.1 as an optional product component. Routing is already integrated into SIMATIC PDM PCS 7 V8.1.

SIMATIC PDM Communication FOUNDATION Fieldbus V8.1 option

With this option, SIMATIC PDM can communicate in a SIMATIC S7/PCS 7 engineering environment with field devices on the FOUNDATION Fieldbus H1 via the FF link.

Option SIMATIC PDM HART Server V8.1

This option supports use of HART multiplexers from various manufacturers in SIMATIC PDM V8.1. Wireless HART field devices can also be parameterized using SIMATIC PDM V8.1.

Option SIMATIC PDM Command Interface V8.1

With this option, the stand-alone product packages SIMATIC PDM Basic and SIMATIC PDM Service can be remotely operated for configuring and field-device operation.

Note: The application is functionally limited in SIMATIC PDM V8.1+SP1 and restricted to applications that are not intended for broad-based use. Programming knowledge is necessary.

SIMATIC PDM TAGs for SIMATIC PDM V8.1

Depending on the project size, the TAGs supplied with a product can be cumulatively expanded with 10, 100 or 1 000 SIMATIC PDM TAGs. A TAG corresponds to a SIMATIC PDM object, which represents individual field devices or components within a project, e.g. measuring instruments, positioners, switching devices or remote I/Os. TAGs are also relevant for diagnostics with the lifelist of SIMATIC PDM. In this case, TAGs are considered to be all recognized devices with diagnostics capability, whose detailed diagnostics is effected through the device description (EDD).

SIMATIC PDM V6.1 product range

SIMATIC PDM stand-alone

SIMATIC PDM Single Point V6.1

This minimum configuration with handheld functionality is designed for processing exactly *one* field device via point-to-point coupling. It cannot be expanded with functions or TAG options/PowerPacks. The device functions are supported as defined in the device description.

The following types of communication are possible:

- PROFIBUS DP/PA
- HART communication (modem, RS 232)
- Modbus

SIMATIC PDM Basic V6.1

Provided the system requirements are met, SIMATIC PDM Basic V6.1 can be used for stand-alone operation on any computer (IPC/notebook) with local connection to bus segments or direct connection to the device. The product package features all the basic functions required for operation and parameter assignment of the devices and is enabled for the following communication modes:

- PROFIBUS DP/PA
- HART communication (modem, RS 232 and via PROFIBUS)
- Modbus
- SIREC bus
- SIPART DR
- Ethernet

As basic module for individual configuration, SIMATIC PDM Basic V6.1 can be expanded with all optional product components, TAG options and PowerPacks for SIMATIC PDM V6.1. Without TAG expansion, SIMATIC PDM Basic V6.1 can manage projects with up to 4 TAGs. Use of the following functions requires at least 128 TAGs:

- Change log
- Calibration report
- Detailed diagnostics in the lifelist

SIMATIC PDM Service V6.1

This is a configured product package especially for mobile use in servicing for projects with up to 128 TAGs. It offers service engineers all functions of SIMATIC PDM Basic V6.1 and special service functions such as change log, calibration report and detailed diagnostics in the lifelist.

SIMATIC PDM Service V6.1 can be expanded by the functional options "SIMATIC PDM Integration in STEP 7/PCS 7 V6.1", "SIMATIC PDM Routing V6.1" and "SIMATIC PDM Communication via Standard HART-Multiplexer V6.1" as well as by SIMATIC PDM PowerPacks.

Design (continued)***SIMATIC PDM system-integrated***SIMATIC PDM S7 V6.1

SIMATIC PDM S7 V6.1 is a product package for projects with up to 128 TAGs and is configured for the use of SIMATIC PDM in a SIMATIC S7 configuration environment. In addition to SIMATIC PDM Service V6.1, it also offers functions for integration in the hardware configurator (HW Config) of STEP 7 (corresponds to the option "SIMATIC PDM Integration in STEP 7/PCS 7").

SIMATIC PDM S7 V6.1 can be expanded by the functional options "SIMATIC PDM Routing V6.1" and "Communication via Standard HART-Multiplexer V6.1" as well as by SIMATIC PDM PowerPacks.

SIMATIC PDM PCS 7 V6.1

The SIMATIC PDM PCS 7 V6.1 product package is designed for projects with up to 128 TAGs. It extends the functionality of SIMATIC PDM Service V6.1 with routing from the central engineering system to the devices in the field and integrates SIMATIC PDM in the SIMATIC PCS 7 configuration environment by means of HW Config.

SIMATIC PDM PCS 7 V6.1 can be expanded by the options "SIMATIC PDM Communication via Standard HART Multiplexer V6.1" and SIMATIC PDM PowerPacks.

Optional product components for SIMATIC PDM V6.1SIMATIC PDM Integration option in STEP 7/PCS 7 V6.1

This option is used for the integration of SIMATIC PDM V6.1 in a SIMATIC S7 or SIMATIC PCS 7 configuration environment. SIMATIC PDM V6.1 can then be started directly from the hardware configurator (HW Config) in STEP 7/SIMATIC PCS 7.

SIMATIC PDM Routing V6.1 option

If you want to use SIMATIC PDM V6.1 in a central engineering system for plant-wide configuration, parameter assignment, commissioning and diagnostics of the devices in the field, you need the "SIMATIC PDM Routing V6.1" option in addition to the "SIMATIC PDM Integration in STEP 7/PCS 7 V6.1" option. From the central engineering system, you can then reach every device in the field that can be configured per EDD throughout the plant and across different bus systems and remote I/Os.

SIMATIC PDM Communication via Standard HART Multiplexer V6.1 option

This option permits SIMATIC PDM to use the HART server for communication with HART field devices via HART multiplexers.

TAG options/PowerPacks for SIMATIC PDM V6.1

A TAG corresponds to a SIMATIC PDM object, which represents individual field devices or components within a project, e.g. measuring instruments, positioners, switching devices or remote I/Os. TAGs are also relevant for diagnostics with the lifelist of SIMATIC PDM. In this case, TAGs are considered to be all recognized devices with diagnostics capability, whose detailed diagnostics is effected through the device description (EDD).

In contrast to PowerPacks, TAG options are only suitable for individual SIMATIC PDM product configurations on the basis of SIMATIC PDM Basic V6.1. Using the SIMATIC PDM TAG options for SIMATIC PDM V6.1, SIMATIC PDM Basic V6.1 can be expanded from 4 TAGs to 128, 512, 1 024 or 2 048 TAGs, and with the help of an additive PowerPack for SIMATIC PDM V6.1 even to unlimited TAGs.

With the PowerPacks for SIMATIC PDM V6.1, product packages based on SIMATIC PDM V6.1 can be provided with additional TAGs. PowerPacks are available for TAG expansion to 512, 1 024, 2 048 and unlimited TAGs.

Demonstration software

SIMATIC PDM V6.1 and SIMATIC PDM V8.1 are also available with demo software for demonstration purposes. Storage functions, export/import and extended functionality cannot be used with the demo software. The communication functions are restricted.

PROFIBUS

Engineering/Network Management/Diagnostics

SIMATIC PDM

Function

The screenshot displays the SIMATIC PDM interface. On the left, a tree view shows the parameter structure for 'SITRANS TJK FA'. The main area shows a table of parameters with columns for Parameter, Value, Unit, Status, and Name. Below this, there are sections for Identification, Operation Unit, and Device. A 'History trend' window is overlaid, showing a line graph of 'Output Value' in degrees Celsius. The graph shows a fluctuating trend over time, with a current value of 23.1 °C. The x-axis represents time from 9:05:00 AM to 9:06:00 AM on 12/29/2011. The y-axis represents the output value from 23.125 to 23.20.

SIMATIC PDM, parameter view and trend window

Core functions

- Adjustment and modification of device parameters
- Comparing (e.g. project and device data)
- Plausibility testing of data input
- Device identification and testing
- Device status indication (operating modes, interrupts, states)
- Simulation
- Diagnostics (standard, detailed)
- Export/import (parameter data, logs, documents)
- Management (e.g. networks and PCs)
- Commissioning functions, e.g. measuring circuit tests of device data
- Device management (lifecycle management)
- Global and device-specific modification logbook for user operations (audit trail)
- Device-specific calibration reports
- Graphic presentations of echo envelope curves, trend displays, valve diagnosis results etc.
- Presentation of incorporated manuals
- Document manager for integration of up to 10 multimedia files

Integration

Device integration

SIMATIC PDM supports all devices described by EDD (Electronic Device Description). EDD is standardized to EN 50391 and IEC 61804. Internationally it is the most widely used standardized technology for device integration. At the same time, it is the guideline of the established organizations for

- PROFIBUS and PROFINET
(PI – PROFIBUS & PROFINET International)
- HART (HCF: HART Communication Foundation)
- FF (Fieldbus Foundation)

The devices are integrated directly in SIMATIC PDM through a company-specific EDD or the current HCF or Fieldbus Foundation libraries. To achieve improved transparency, they can be managed in project-specific device libraries.

Field devices are described in the EDD in terms of functionality and construction using the Electronic Device Description Language (EDDL). Using this description, SIMATIC PDM automatically creates its user interface with the specific device data. Existing devices can be updated, and further devices integrated into SIMATIC PDM, by simply importing the manufacturer's device-specific EDD.

Fieldbus Foundation provides pre-defined device descriptions (standard DD) for the basic functions of specific field device types. The basic functions are implemented using various standard function and transmission blocks.

Technical support

If you wish to use devices which cannot be found in the SIMATIC PDM device description library, we would be pleased to help you integrate them.

Support Request

You can request support by service specialists at Technical Support by using a "Support Request" on the Internet:

<http://www.siemens.com/automation/support-request>

Contacts in the Region

The Technical Support responsible for your Region can be found on the Internet at:

<http://www.automation.siemens.com/partner>

Technical specifications

	SIMATIC PDM V6.1	SIMATIC PDM V8.1
Hardware	<ul style="list-style-type: none"> PG/PC/notebook with processor corresponding to operating system requirements 	<ul style="list-style-type: none"> PG/PC/notebook with processor corresponding to operating system requirements
Operating systems (alternative)	<ul style="list-style-type: none"> Microsoft Windows XP Professional SP3, 32-bit Microsoft Windows Server 2003 R2 SP2, 32-bit, Standard Edition 	<ul style="list-style-type: none"> Windows XP Professional SP3 (32-bit) Windows Server 2003 SP2 Standard Edition (32-bit) Windows Server 2003 R2 SP2 Standard Edition (32-bit) Windows 7 Professional/Ultimate/Enterprise SP1 (32-bit/64-bit) Windows Server 2008 SP2 Standard Edition (32-bit) Windows Server 2008 R2 SP1 Standard Edition (64-bit)
Integration in STEP 7/PCS 7	<ul style="list-style-type: none"> STEP 7 V5.3+SP2 STEP 7 V5.4+SP5 STEP 7 V5.5 or V5.5+SP1/SP2/SP3 SIMATIC PCS 7 V6.1+SP4 SIMATIC PCS 7 V7.1 or V7.1+SP1/SP2/SP3 SIMATIC PCS 7 V8.0 or V8.0+SP1 	<ul style="list-style-type: none"> SIMATIC PCS 7 V8.0+SP1 (SIMATIC PCS 7 V8.0 without PROFINET communication) STEP 7 V5.5+SP3 (STEP 7 V5.5+SP2 without PROFINET communication)

Ordering data

Article No.

Article No.

SIMATIC PDM V8.1

SIMATIC PDM stand-alone product packages

Minimum configuration

SIMATIC PDM Single Point V8.1

for operation and configuration of one field device; communication via PROFIBUS DP/PA, HART (modem, RS 232, PROFIBUS/PROFINET), Modbus, Ethernet or PROFINET, including 1 TAG

cannot be expanded with respect to functions or with TAG option/PowerPack

6 languages (English, German, French, Italian, Spanish, Chinese), software class A, runs with Windows XP Professional 32-bit, Windows 7 Ultimate 32/64-bit, Windows Server 2003 R2 Standard 32-bit, or Windows Server 2008 R2 Standard 64-bit, floating license for 1 user

- Delivery form package SIMATIC PDM software and device library on DVD, license key on USB stick, certificate of license

- Delivery form online Software image download (SIMATIC PDM and device library), license key download, online certificate of license

Note:
E-mail address required!

6ES7658-3HA18-0YA5

6ES7658-3HA18-0YH5

Basic configuration for individual product packages

SIMATIC PDM Basic V8.1

Product package for operation and configuration of field devices and components; communication via PROFIBUS DP/PA, HART (modem, RS 232, PROFIBUS/PROFINET), Modbus, Ethernet or PROFINET, including 4 TAGs

6 languages (English, German, French, Italian, Spanish, Chinese), software class A, runs with Windows XP Professional 32-bit, Windows 7 Ultimate 32/64-bit, Windows Server 2003 R2 Standard 32-bit, or Windows Server 2008 R2 Standard 64-bit, floating license for 1 user

- Delivery form package SIMATIC PDM software and device library on DVD, license key on USB stick, certificate of license

- Delivery form online Software image download (SIMATIC PDM and device library), license key download, online certificate of license

Note:
E-mail address required!

6ES7658-3AB18-0YA5

6ES7658-3AB18-0YH5

PROFIBUS

Engineering/Network Management/Diagnostics

SIMATIC PDM

Ordering data

Article No.

Article No.

Application-specific configuration for mobile service

SIMATIC PDM Service V8.1

Product package for stand-alone user in service, with

- SIMATIC PDM Basic
- 100 TAGs

6 languages (English, German, French, Italian, Spanish, Chinese), software class A, runs with Windows XP Professional 32-bit, Windows 7 Ultimate 32/64-bit, Windows Server 2003 R2 Standard 32-bit, or Windows Server 2008 R2 Standard 64-bit, floating license for 1 user

- Delivery form package
SIMATIC PDM software and device library on DVD, license key on USB stick, certificate of license

- Delivery form online
Software image download (SIMATIC PDM and device library), license key download, online certificate of license

Note:

E-mail address required!

6ES7658-3JD18-0YA5

6ES7658-3JD18-0YH5

Application-specific configuration for integration in SIMATIC S7 configuration environment

SIMATIC PDM S7 V8.1

Product package for use in a SIMATIC S7 engineering environment, with

- SIMATIC PDM Basic and Extended
- Integration in STEP 7/PCS 7
- 100 TAGs

6 languages (English, German, French, Italian, Spanish, Chinese), software class A, runs with Windows XP Professional 32-bit, Windows 7 Ultimate 32/64-bit, Windows Server 2003 R2 Standard 32-bit, or Windows Server 2008 R2 Standard 64-bit, floating license for 1 user

Note:

SIMATIC PDM S7 V8.1 requires the installation of STEP 7 V5.5+SP2/SP3! PROFINET communication is supported as of STEP 7 V5.5+SP3.

- Delivery form package
SIMATIC PDM software and device library on DVD, license key on USB stick, certificate of license

- Delivery form online
Software image download (SIMATIC PDM and device library), license key download, online certificate of license

Note:

E-mail address required!

6ES7658-3KD18-0YA5

6ES7658-3KD18-0YH5

Application-specific configuration for integration in SIMATIC PCS 7 configuration environment

SIMATIC PDM PCS 7 V8.1

Complete package for integration into the engineering toolset of the SIMATIC PCS 7 engineering system

6 languages (English, German, French, Italian, Spanish, Chinese), software class A, runs with Windows XP Professional 32-bit, Windows 7 Ultimate 32/64-bit, Windows Server 2003 R2 Standard 32-bit or Windows Server 2008 R2 Standard 64-bit,

- Floating license for 1 user, with
- SIMATIC PDM Basic and Extended
- Integration in STEP 7/PCS 7
- Routing
- 100 TAGs

Note:

SIMATIC PDM PCS 7 V8.1 requires the installation of SIMATIC PCS 7 V8.0 or higher! PROFINET communication is supported as of SIMATIC PCS 7 V8.0+SP1.

- Delivery form package
(without SIMATIC PCS 7 Software Media Package)
SIMATIC PDM software and device library on DVD, license key USB stick, certificate of license

- Delivery form online
(without SIMATIC PCS 7 Software Media Package)
Software image download (SIMATIC PDM and device library), license key download, online certificate of license
- Note: E-mail address required!

6ES7658-3LD18-0YA5

6ES7658-3LD18-0YH5

SIMATIC PDM PCS 7-FF V8.1

Complete package for integration into the engineering toolset of the SIMATIC PCS 7 engineering system

6 languages (English, German, French, Italian, Spanish, Chinese), software class A, runs with Windows XP Professional 32-bit, Windows 7 Ultimate 32/64-bit, Windows Server 2003 R2 Standard 32-bit or Windows Server 2008 R2 Standard 64-bit,

- Floating license for 1 user, with
- SIMATIC PDM Basic and Extended
- Integration in STEP 7/PCS 7
- Routing
- FOUNDATION Fieldbus communication
- 100 TAGs

Note:

SIMATIC PDM PCS 7-FF V8.1 requires the installation of SIMATIC PCS 7 V8.0 or higher! PROFINET communication is supported as of SIMATIC PCS 7 V8.0+SP1.

- Delivery form package
(without SIMATIC PCS 7 Software Media Package)
SIMATIC PDM software and device library on DVD, license key USB stick, certificate of license

- Delivery form online
(without SIMATIC PCS 7 Software Media Package)
Software image download (SIMATIC PDM and device library), license key download, online certificate of license

Note:

E-mail address required!

6ES7658-3MD18-0YA5

6ES7658-3MD18-0YH5

3

Ordering data

Article No.

Article No.

*Optional product components for SIMATIC PDM V8.1***SIMATIC PDM Extended V8.1**

6 languages (English, German, French, Italian, Spanish, Chinese), software class A, runs with Windows XP Professional 32-bit, Windows 7 Ultimate 32/64-bit, Windows Server 2003 R2 Standard 32-bit, or Windows Server 2008 R2 Standard 64-bit,

floating license for 1 user

- Delivery form package
License key on USB stick, certificate of license

- Delivery form online
License key download, online certificate of license

Note:
E-mail address required!

6ES7658-3NX18-2YB5

6ES7658-3NX18-2YH5

SIMATIC PDM Integration in STEP 7/SIMATIC PCS 7 V8.1

only required for integration of SIMATIC PDM into HW Config
6 languages (English, German, French, Italian, Spanish, Chinese), software class A, runs with Windows XP Professional 32-bit, Windows 7 Ultimate 32/64-bit, Windows Server 2003 R2 Standard 32-bit, or Windows Server 2008 R2 Standard 64-bit,

floating license for 1 user

- Delivery form package
License key on USB stick, certificate of license

- Delivery form online
License key download, online certificate of license

Note:
E-mail address required!

6ES7658-3BX18-2YB5

6ES7658-3BX18-2YH5

SIMATIC PDM Routing V8.1

6 languages (English, German, French, Italian, Spanish, Chinese), software class A, runs with Windows XP Professional 32-bit, Windows 7 Ultimate 32/64-bit, Windows Server 2003 R2 Standard 32-bit, or Windows Server 2008 R2 Standard 64-bit,

floating license for 1 user

- Delivery form package
License key on USB stick, certificate of license

- Delivery form online
License key download, online certificate of license

Note:
E-mail address required!

6ES7658-3CX18-2YB5

6ES7658-3CX18-2YH5

SIMATIC PDM Communication FOUNDATION Fieldbus V8.1

6 languages (English, German, French, Italian, Spanish, Chinese), software class A, runs with Windows XP Professional 32-bit, Windows 7 Ultimate 32/64-bit, Windows Server 2003 R2 Standard 32-bit, or Windows Server 2008 R2 Standard 64-bit,

floating license for 1 user

- Delivery form package
(without SIMATIC PCS 7 Software Media Package)
License key USB stick, certificate of license

- Delivery form online
(without SIMATIC PCS 7 Software Media Package)
License key download,

online certificate of license

Note:
E-mail address required!

6ES7658-3QX18-2YB5

6ES7658-3QX18-2YH5

SIMATIC PDM HART Server V8.1

6 languages (English, German, French, Italian, Spanish, Chinese), software class A, runs with Windows XP Professional 32-bit, Windows 7 Ultimate 32/64-bit, Windows Server 2003 R2 Standard 32-bit, or Windows Server 2008 R2 Standard 64-bit,

floating license for 1 user

- Delivery form package
(without SIMATIC PCS 7 Software Media Package)
License key USB stick,

certificate of license

- Delivery form online
(without SIMATIC PCS 7 Software Media Package)
License key download,

online certificate of license

Note:
E-mail address required!

6ES7658-3EX18-2YB5

6ES7658-3EX18-2YH5

SIMATIC PDM Command Interface V8.1

6 languages (English, German, French, Italian, Spanish, Chinese), software class A, runs with Windows XP Professional 32-bit, Windows 7 Ultimate 32/64-bit, Windows Server 2003 R2 Standard 32-bit, or Windows Server 2008 R2 Standard 64-bit,

floating license for 1 user

- Delivery form package
(without SIMATIC PCS 7 Software Media Package)
License key USB stick,

certificate of license

6ES7658-3SX18-2YB5

PROFIBUS

Engineering/Network Management/Diagnostics

SIMATIC PDM

Ordering data

Article No.

Article No.

SIMATIC PDM TAGs for SIMATIC PDM V8.1

SIMATIC PDM TAGs

TAG licenses for expanding SIMATIC PDM product packages V7.0 or higher, can be accumulated, software class A, floating license for 1 user

- Delivery form package
 - License key on USB stick, certificate of license
 - 10 TAGs
 - 100 TAGs
 - 1 000 TAGs
- Delivery form online
 - License key download, online certificate of license
 - Note:
 - E-mail address required!
 - 10 TAGs
 - 100 TAGs
 - 1 000 TAGs

6ES7658-3XC00-2YB5
6ES7658-3XD00-2YB5
6ES7658-3XE00-2YB5

6ES7658-3XC00-2YH5
6ES7658-3XD00-2YH5
6ES7658-3XE00-2YH5

Demonstration software

SIMATIC PDM Demo V8.1

Storage functions, export/import and advanced functionality disabled; communication functions restricted

6 languages (English, German, French, Italian, Spanish, Chinese), software class A, runs with Windows XP Professional 32-bit, Windows 7 Ultimate 32/64-bit, Windows Server 2003 R2 Standard 32-bit or Windows Server 2008 R2 Standard 64-bit

Delivery form package
 SIMATIC PDM software and device library on DVD

6ES7658-3GX18-0YT8

SIMATIC PDM V6.1

SIMATIC PDM stand-alone product packages

Minimum configuration

SIMATIC PDM Single Point V6.1

for operation and configuration of one field device; communication via PROFIBUS DP/PA, HART modem or Modbus, including 1 TAG

cannot be expanded with respect to functions or with TAG option/PowerPack

6 languages (English, German, French, Italian, Spanish, Chinese), software class A, runs with Windows XP Professional/ Server 2003, floating license for 1 user

Delivery form package
 SIMATIC PDM software and device library on CD/DVD, license key on USB stick, certificate of license

6ES7658-3HX16-0YA5

Application-specific configuration for mobile service

SIMATIC PDM Service V6.1

Product package for stand-alone user in service, with

- SIMATIC PDM Basic V6.1
- 128 TAGs

6 languages (English, German, French, Italian, Spanish, Chinese), software class A, runs with Windows XP Professional/ Server 2003, floating license for 1 user

Delivery form package
 SIMATIC PDM software and device library on CD/DVD, license key on USB stick, certificate of license

6ES7658-3JX16-0YA5

Basic configuration for individual product packages

SIMATIC PDM Basic V6.1

Product package for operator input and configuration of field devices and components, communication via PROFIBUS DP/PA, HART (modem, RS 232, PROFIBUS), SIREC bus, SIPART DR, Modbus or Ethernet, including 4 TAGs

6 languages (English, German, French, Italian, Spanish, Chinese), software class A, runs with Windows XP Professional/ Server 2003, floating license for 1 user

Delivery form package
 SIMATIC PDM software and device library on CD/DVD, license key on USB stick, certificate of license

6ES7658-3AX16-0YA5

Ordering data**Article No.****Article No.***SIMATIC PDM system-integrated product packages**Application-specific configuration for integration in SIMATIC S7 configuration environment***SIMATIC PDM S7 V6.1**

Product package for use in a SIMATIC S7 configuration environment, with

- SIMATIC PDM Basic V6.1
- Integration in STEP 7/PCS 7
- 128 TAGs

6 languages (English, German, French, Italian, Spanish, Chinese), software class A, runs with Windows XP Professional/ Server 2003, floating license for 1 user

Delivery form package
SIMATIC PDM software and device library on CD/DVD,
license key on USB stick,
certificate of license

6ES7658-3KX16-0YA5*Application-specific configuration for integration in SIMATIC PCS 7 configuration environment***SIMATIC PDM PCS 7 V6.1**

Complete package for integration into the engineering toolset of the SIMATIC PCS 7 engineering system

6 languages (English, German, French, Italian, Spanish, Chinese), software class A, runs with Windows XP Professional/ Server 2003

Floating license for 1 user, with

- SIMATIC PDM Basic
- Integration in STEP 7/PCS 7
- Routing
- 128 TAGs

Delivery form package
(without SIMATIC PCS 7 Software Media Package):
SIMATIC PDM software and device library on CD/DVD,
license key on USB stick,
certificate of license

6ES7658-3LX16-0YA5*Optional product components for SIMATIC PDM V6.1***SIMATIC PDM integration in STEP 7/SIMATIC PCS 7 V6.1**

only required for integration of SIMATIC PDM into HW Config

6 languages (English, German, French, Italian, Spanish, Chinese), software class A, runs with Windows XP Professional/ Server 2003, floating license for 1 user

Delivery form package
License key on USB stick,
certificate of license

6ES7658-3BX16-2YB5**SIMATIC PDM Routing V6.1**

6 languages (English, German, French, Italian, Spanish, Chinese), software class A, runs with Windows XP Professional/ Server 2003, floating license for 1 user

Delivery form package
License key on USB stick,
certificate of license

6ES7658-3CX16-2YB5**SIMATIC PDM Communication via standard HART multiplexer V6.1**

6 languages (English, German, French, Italian, Spanish, Chinese), software class A, runs with Windows XP Professional/Server 2003, floating license for 1 user

Delivery form package
License key on USB stick,
certificate of license

6ES7658-3EX16-2YB5*TAG options/PowerPacks for SIMATIC PDM V6.1***SIMATIC PDM TAG option**

for TAG expansion, additive to SIMATIC PDM Basic V6.1

Software class A, runs with Windows XP Professional/Server 2003, floating license for 1 user

Delivery form package
License key on USB stick,
certificate of license

- Up to 128 TAGs
- Up to 512 TAGs
- Up to 1 024 TAGs
- Up to 2 048 TAGs

6ES7658-3XA16-2YB5**6ES7658-3XB16-2YB5****6ES7658-3XC16-2YB5****6ES7658-3XD16-2YB5****SIMATIC PDM PowerPack**

for TAG expansion,
for any SIMATIC PDM V6.1 product packages

Software class A,
runs with Windows XP Professional/ Server 2003,
floating license for 1 user

Delivery form package
License key on USB stick,
certificate of license

- 128 TAGs to 512 TAGs
- 512 TAGs to 1 024 TAGs
- 1 024 TAGs to 2 048 TAGs
- 2 048 TAGs to unlimited TAGs

6ES7658-3XB16-2YD5**6ES7658-3XC16-2YD5****6ES7658-3XD16-2YD5****6ES7658-3XH16-2YD5***Demonstration software***SIMATIC PDM Demo V6.1**

Without online communication and storage functionality

6 languages (English, German, French, Italian, Spanish, Chinese), software class A,
runs with Windows XP Professional/ Server 2003

Delivery form package
(without SIMATIC PCS 7 Software Media Package)
SIMATIC PDM software and device library on CD/DVD

6ES7658-3GX16-0YC8

PROFIBUS

Engineering/Network Management/Diagnostics

SIMATIC PDM

More information

Update/Upgrade

Product packages and optional product components from the product range of SIMATIC PDM V6.0, V6.1 or V8.0 can be directly upgraded to V8.1 (incl. service pack).

Exception: SIMATIC PDM Single Point and SIMATIC PDM Communication via standard HART multiplexer.

Product packages and optional product components from the product range of SIMATIC PDM V7.0 can first be upgraded to V8.0 and then to V8.1.

When upgrading to SIMATIC PDM V8.1, be aware of the compatible versions of SIMATIC PCS 7 and STEP 7.

A Software Update Service in the form of a subscription is also offered for SIMATIC PDM.

For additional information, see the subsections "Updates/upgrades asynchronous to the PCS 7 version" and "Software Update Service" in the "Update/upgrade packages" section.

Overview

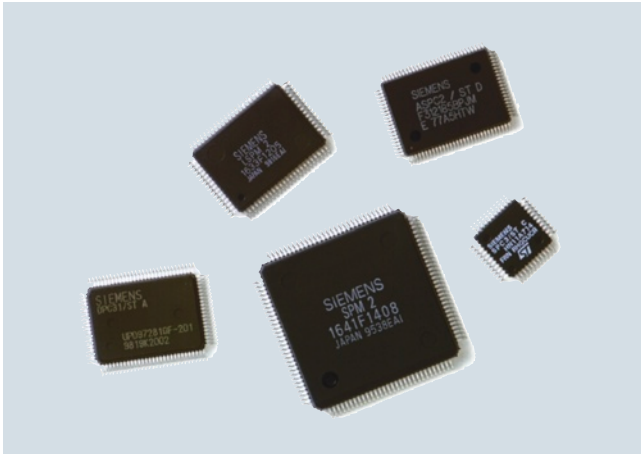

- Easy connection of field devices to PROFIBUS
- Integrated low power management
- Different ASICs for the different functional requirements and application areas

Application

The PROFIBUS DP ASICs allow equipment manufacturers to connect their devices to PROFIBUS easily.

They can be implemented at transmission rates of up to 12 Mbit/s.

The following blocks are available for different functional requirements and fields of application:

- Master applications:
ASPC 2
- Intelligent slaves:
SPC 3 and SPC3LV for PROFIBUS DP, with hardware-controlled bus access;
DPC 31 with integral 8031 core;
SPC 4-2.
- Connection in intrinsically safe systems:
SIM 1-2 for physical connection in intrinsically safe fieldbus systems as a Medium Attachment Unit for IEC 61158-2 at 31.25 Kbit/s. Especially for combining with the SPC 4-2 and DPC 31.
- Simple slaves:
LSPM 2 with 32 input/output bits for confined spaces
- Connection to fiber-optic conductors:
FOCSI module for electrical conditioning of signals already received or to be sent. The module ensures that the optically transmitted signals are properly electrically restored (retiming/retriggering)

For initial development, order quantities of 5/6 ASICs are possible (not suitable for batch assembly because the pins of the ASIC can be bent due to the packaging; packing units larger than 5/6 units must be used)

The number of ASICs per packing unit depends on the ASIC type (see ordering data).

The ASICs ASPC 2, SPC3, SPC3LV, DPC31, LSPM2 and FOCSI can also be supplied in a lead-free design.

Design

ASPC 2

The ASPC 2 is a preprocessing communications chip for master applications with a maximum transmission rate of 12 Mbit/s. The ASIC has not been disclosed. The brief user manual describes the pins and the electrical properties of the ASPC 2. A separate microprocessor and the appropriate firmware are required for operation. The firmware is tuned to the 80C165 processor and can be obtained by purchasing a license.

SPC 3

The SPC 3 is a preprocessing communications chip with a processor interface. The SPC 3 processes message frame identification, address identification, execution of the data back-up sequences and protocol processing for PROFIBUS DP.

Firmware is offered for the Siemens SPC 3 (see ordering data).

SPC 3LV

The product portfolio for intelligent PROFIBUS slave applications was expanded by a 3.3 V version. The SPC3LV is 100% compatible in terms of functions and pins to the 5 V version (SPC3).

DPC 31

The DPC 31 is a preprocessing communications module with a processor interface and an integrated processor core (C31 core).

It supports the connection of intelligent field devices as slaves on PROFIBUS DP and PROFIBUS PA.

The DPC 31 autonomously processes all communications tasks and has, in addition, an integral C31 core for further applications. It combines the communication properties of the ASICs SPC 3 and SPC 4-2 in one chip. The integrated C31 core can also be programmed as required. Firmware is offered for the Siemens ASIC DPC 31 (see ordering data).

SPC 4-2

The SPC 4-2 is a preprocessing communications chip with a processor interface. It is designed for combined applications and due to the Low Power Management function, it is ideally suited to use in intrinsically safe applications. Firmware is offered for the SPC 4-2 by the company TMG itec¹⁾. The signals are converted for PROFIBUS PA using the SIM 1-2 module.

¹⁾ Order from:
TMG itec
76137 Karlsruhe
Tel. +49 (0)721 82 80 60

PROFIBUS

PROFIBUS Components

PROFIBUS DP ASICs

Design (continued)

SIM 1-2

The SIM 1-2 supplements the SPC 4-2 or DPC 31. Only a few external components are required in addition to these ASICs to be able to connect field devices to an intrinsically safe network in accordance with PROFIBUS PA. In combination with the SPC 4-2 or DPC 31, the functions of a PROFIBUS PA slave can be processed from physical linking through to communication control.

SIM 1-2 supports all send and receive functions (including Jabber Control) as well as the high-resistance decoupling of auxiliary power from the bus cable. It provides an adjustable, stabilized supply voltage and also supports configuration of an electrically isolating power supply with just a few passive components.

The ASIC contains a special interface logic which provides a low-overhead, minimum power interface for galvanic signal separation as an alternative to the standard signal interface.

It can be connected to all Manchester encoders/decoders to the IEC 61 158-2 standard at 31.25 kbit/s.

LSPM 2

LSPM 2 is a single-chip solution with 32 input/output bits. It processes all bus communication autonomously. An additional microprocessor and firmware are not required. The compact MQFP casing with 80 pins makes it ideal for applications with low space requirements.

FOCSI

This ASIC functions as an expansion to the existing PROFIBUS ASICs. The FOCSI module (Fiber Optic Controller from Siemens) ensures proper electrical conditioning and transfer of the received/sent optical signal. To inject the signal into a fiber-optic conductor, apart from FOCSI, the appropriate optical transmitter and receiver will be required. FOCSI can be used with the PROFIBUS DP ASICs described above.

Additional ordering data available on request

Technical specifications

	LSPM 2	SPC 3	SPC 3LV	DPC 31
Protocol	PROFIBUS DP	PROFIBUS DP	PROFIBUS DP	PROFIBUS DP, PROFIBUS PA
Application range	simple slave application	intelligent slave application	intelligent slave application	intelligent slave application
Transmission rate, max.	12 Mbit/s	12 Mbit/s	12 Mbit/s	12 Mbit/s
Bus access	in ASIC	in ASIC	in ASIC	in ASIC
Automatic determination of transmission rate	yes	yes	yes	yes
Microprocessor required	no	yes	yes	integrated
Scope of firmware	not required	6 to 24 KB	6 to 24 KB	approx. 38 KB
Message buffer	-	1.5 KB	1.5 KB	6 KB
Power supply	5 V DC	5 V DC	3.3 V DC	3.3 V DC
Power loss, max.	0.35 W	0.5 W	<0.5 W	0.2 W
Permissible ambient temperature	-40 °C ... +75 °C	-40 °C ... +85 °C	-40 °C ... +85 °C	-40 °C ... +85 °C
Housing	MQFP, 80-pin	PQFP, 44-pin	PQFP, 44-pin	PQFP, 100-pin
Frame size	4 cm ²	2 cm ²	2 cm ²	4 cm ²
Delivery quantities (pcs.)	6/66/330/4 950	6/96/750/960/4 800	5/160/800/1 000/4 800	STEP B: 6/60/300/5 100 STEP C1: 6/66/660/4 620

	SPC 4-2	ASPC 2	SIM 1-2	FOCSI
Protocol	PROFIBUS DP PROFIBUS FMS PROFIBUS PA	PROFIBUS DP PROFIBUS FMS PROFIBUS PA	PROFIBUS PA	-
Application range	Intelligent slave application	Master application	Medium Attachment	Medium Management Unit
Transmission rate, max.	12 Mbit/s	12 Mbit/s	31.25 kbit/s	12 Mbit/s
Bus access	in ASIC	in ASIC	-	-
Automatic determination of transmission rate	yes	yes	-	-
Microprocessor required	yes	yes	-	-
Scope of firmware	3 ... 30 KB	80 KB	not required	not required
Message buffer	3 KB	1 MB (external)	-	-
Voltage supply	5 V DC, 3.3 V	5 V DC	via bus	3.3 V DC
Power loss, max.	0.6 W at 5 V 0.01 W at 3.3 V	0.9 W	0.05 W	0.75 W
Permissible ambient temperature	-40 °C ... +85 °C	-40 °C ... +85 °C	-40 °C ... +85 °C	-40 °C ... +85 °C
Housing	TQFP, 44-pin	P-MQFP, 100-pin	MLPQ, 40-pin	TQFP, 44-pin
Frame size	2 cm ²	4 cm ²	36 mm ²	2 cm ²
Delivery quantities (pcs.)	5/160	6/66/660/4 620	30/60/1 000	40

Ordering data	Article No.	Article No.
ASIC ASPC 2 For constructing master interfaces (quantity discount) <ul style="list-style-type: none"> • 6 units (lead-free) • 66 units (lead-free) • 660 units (lead-free) • 4 620 units (lead-free) 	6ES7195-0AA05-0XA0 6ES7195-0AA15-0XA0 6ES7195-0AA25-0XA0 6ES7195-0AA35-0XA0	ASIC DPC 31 STEP B For constructing intelligent DP slave interfaces (quantity discounts) <ul style="list-style-type: none"> • 6 units (lead-free) • 60 units (lead-free) • 300 units (lead-free) • 5 100 units (lead-free)
ASIC LSPM 2 For constructing simple slave interfaces (quantity discount) <ul style="list-style-type: none"> • 6 units (lead-free) • 66 units (lead-free) • 330 units (lead-free) • 4 950 units (lead-free) 	6ES7195-0BA02-0XA0 6ES7195-0BA12-0XA0 6ES7195-0BA22-0XA0 6ES7195-0BA32-0XA0	ASIC DPC 31 STEP C1 For constructing intelligent DP slave interfaces (quantity discounts) <ul style="list-style-type: none"> • 6 units (lead-free) • 66 units (lead-free) • 660 units (lead-free) • 4 620 units (lead-free)
ASIC SPC 3 For constructing intelligent DP slave interfaces (quantity discounts) <ul style="list-style-type: none"> • 6 units (lead-free) • 96 units (lead-free) • 960 units (lead-free) • 4 800 units (lead-free) • 750 units (lead-free) T&R 	6ES7195-0BD04-0XA0 6ES7195-0BD14-0XA0 6ES7195-0BD24-0XA0 6ES7195-0BD34-0XA0 6ES7195-0BD44-0XA0	ASIC SPC 4-2 For constructing intelligent DP slave interfaces (quantity discounts) <ul style="list-style-type: none"> • 5 units for laboratory development (lead-free) • 160 units (lead-free, 1 tray)
ASIC SPC 3LV For constructing intelligent DP slave interfaces (quantity discounts) <ul style="list-style-type: none"> • 5 units (lead-free) • 160 units (lead-free) • 800 units (lead-free) • 4 800 units (lead-free) • 1 000 units (lead-free) T&R 	6ES7195-0BG00-0XA0 6ES7195-0BG10-0XA0 6ES7195-0BG20-0XA0 6ES7195-0BG30-0XA0 6ES7195-0BG40-0XA0	ASIC SIM 1-2 For connection according to IEC H1 for PROFIBUS PA with a transmission rate of 31.25 kbit/s <ul style="list-style-type: none"> • 60 units (in tube) • 1 000 units (tape & reel)
ASIC FOCSI Fiber Optic Controller from Siemens for conditioning signals for the optical PROFIBUS <ul style="list-style-type: none"> • 40 units (lead-free) 	6ES7195-0EA20-0XA0	Accessories Firmware for Siemens ASIC SPC 3 <ul style="list-style-type: none"> • DP firmware • DPV1 firmware • DPV1 firmware upgrade
		Firmware for Siemens ASIC DPC 31 <ul style="list-style-type: none"> • DPV1 firmware
		6ES7195-0BE02-0XA0 6ES7195-0BE12-0XA0 6ES7195-0BE22-0XA0 6ES7195-0BE32-0XA0 6ES7195-0BF02-0XA0 6ES7195-0BF12-0XA0 6ES7195-0BF22-0XA0 6ES7195-0BF32-0XA0 6GK1588-3AA00 6GK1588-3AA15 6GK1588-3BB02 6GK1588-3BB21 6ES7195-2BA00-0XA0 6ES7195-2BA01-0XA0 6ES7195-2BA02-0XA0 6ES7195-2BB00-0XA0

More information

Brochures

Information material for downloading can be found in the Internet:

<http://www.siemens.com/simatic/printmaterial>

Support

Please contact the following Competence Centers for any technical questions:

Germany and Europe

Siemens AG
 Communication, Development & Certification (ComDeC)
 PO Box 23555
 90713 Fürth, Germany
 Tel.: +49 (911) 750-2080
 Fax: +49 (911) 750-2100
 E-mail: comdec@siemens.com

USA and International

PROFI Interface Center (PIC)
 One Internet Plaza
 PO Box 4991
 Johnson City, TN 37602-4991
 Tel.: +1 (423) - 262 - 2969
 Fax: +1 (423) - 262 - 2103
 E-mail: profibus.sea@siemens.com

PROFIBUS

PROFIBUS Components

Connections/interfaces

Overview

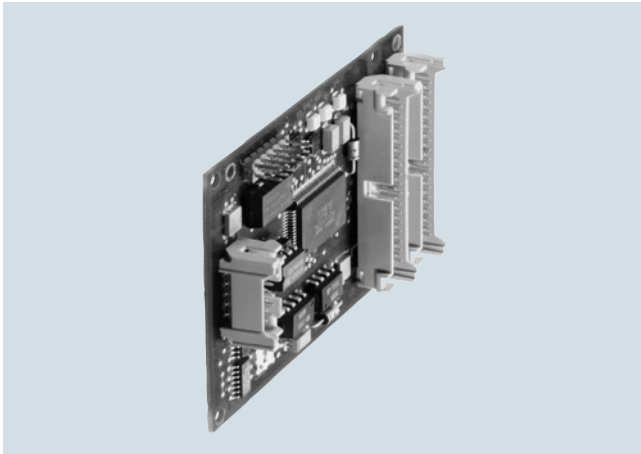

- PC slave board IM 182-1 for the connection of AT-compatible PCs as DP slaves

Application

The PROFIBUS DP interface module IM 182-2 makes it easy to connect a slave to PROFIBUS DP. It is based on the ASIC SPC 3 of Siemens AG. The interface module can be implemented up to a transmission rate of 12 Mbit/s.

Design

IM 182-1 PC slave board

The simple IM 182-1 PC slave card (ISA bus) is based on the ASIC SPC 3. It contains all the physical bus components. A 9-pin Sub-D connector is used for connecting to PROFIBUS DP.

The firmware of the SPC 3 can be used as an accessory on the PC. The 1.5 KB RAM of the SPC 3 forms the interface to the host system. A driver for Windows NT is also offered.

Technical specifications

6ES7 182-0AA01-0XA0	
General information	
Application area	Slave applications
ASIC	SPC 3
• Scope of firmware	4 to 24 KB (incl. test program)
Supply voltage	
5 V DC	Yes
Input current	
Current consumption, typ.	250 mA
Processor	
Microprocessor type	Processor of the PG/PC
Interfaces	
PROFIBUS DP	
• Transmission rate, max.	12 Mbit/s
Protocols	
PROFIBUS DP	Yes
Ambient conditions	
Operating temperature	
• Min.	0 °C
• Max.	60 °C
Dimensions	
Width	168 mm
Height	105 mm

Ordering data

Article No.

SIMATIC S5/S7 IM 182-1 PC slave board

6ES7182-0AA01-0XA0

For PROFIBUS DP, max. 12 Mbit/s

Accessories

Firmware for Siemens ASIC SPC 3 and IM 182-1

- DP firmware
- DPV1 firmware
- DPV1 firmware upgrade

6ES7195-2BA00-0XA0

6ES7195-2BA01-0XA0

6ES7195-2BA02-0XA0

More information

Brochures

Information material for downloading can be found in the Internet:

<http://www.siemens.com/simatic/printmaterial>

Manuals

Manuals for PROFIBUS DP connections are available free in the Internet.

Support

Please contact the following Competence Centers for any technical questions:

Germany and Europe

Siemens AG
Communication, Development & Certification (ComDeC)
PO Box 23555
90713 Fürth, Germany
Tel.: +49 (911) 750-2080
Fax: +49 (911) 750-2100
E-mail: comdec@siemens.com

USA and International

PROFI Interface Center (PIC)
One Internet Plaza
PO Box 4991
Johnson City, TN 37602-4991
Tel.: +1 (423) - 262 - 2969
Fax: +1 (423) - 262 - 2103
E-mail: profibus.sea@siemens.com

Overview

Development kit

Using the development kits, PROFIBUS hardware and software applications can be developed and tested using the PROFIBUS ASICs DPC31.

The comprehensive, perfectly interacting hardware and software components considerably reduce the development costs for a PROFIBUS device.

The kits provide a fully functional hardware development environment which development engineers can build on with their special requirements for hardware and software. The kit documentation is supplied on CD in English and German.

The kits make our PROFIBUS know-how accessible to other users. The development team is available to provide advice to new users even with their own developments - this consultancy service is also a component part of the development kit.

Following completion of a development, devices can be certified by our experts in the PROFIBUS interface centers – we can help new users here, too.

PROFIBUS DP/PA development kit

The kit facilitates set up of PROFIBUS slaves with a variety of PROFIBUS standards:

- PROFIBUS DP-V1 (RS485)
- PROFIBUS PA (IEC 1158) and
- PROFIBUS based on fiber-optic cables.

The development environment shows applications implemented using PROFIBUS-ASICs DPC 31.

Hardware included:

- DPC 31 development board; for developing/testing proprietary applications
- CP 5613; serves as master interface for the PC (PCI card)
- Optical bus terminal; for conversion of copper cables to FOCs
- Pre-assembled PROFIBUS cables

Software included:

- Testing and simulation software under WinNT for use on the PC in connection with the CP 5613 master module
- Sample program for the DPC 31 board
- DPC 31 DPV1 original firmware, including developer license
- Parameterization software for CP 5613 "COM PROFIBUS" for DP operation

When developing PROFIBUS PA applications, order a PROFIBUS DP/PA coupler (6ES7 157-0AC80-0XA0) separately. The DP/PA coupler converts the PROFIBUS DP physical specifications into those of PROFIBUS PA. This module is not included in the development kit!

PROFIsafe starter kit V3.4

The PROFIsafe starter kit V3.4 is compatible with version 2.4 of the PROFIsafe profile, as specified in IEC 61784-3-3. It meets a series of user requirements such as multi-instance capability and variable process data length at runtime.

Along with all of the PI specifications required for development, the PROFIsafe starter kit contains the source files for the PROFIsafe driver software (PSD) and a comprehensive implementation manual in English and German. In addition, it includes various CRC calculation tools and tools for creating GSD files with security-related parameters.

Examples of adaptation of the PSD (PROFIsafe Driver) to current PROFIBUS and PROFINET stack interfaces provide assistance for adaptations that may be necessary. Special "slow motion monitors" allow the PROFIsafe protocol processes to be monitored in slow motion. A new feature is support for the iPar server and the TCI interface.

Example applications are provided on the CD-ROM for both PROFIBUS and PROFINET. The hardware components supplied in the development kits offer the user access to the PROFIsafe world, step-by-step.

The PROFIsafe starter kit consists of the following components:

- Current PROFIsafe specifications with current PROFIsafe certificate
- PROFIsafe driver software (as core component of the development package)
- Example GSD file for STEP7 (for PROFIBUS DP/PA development package and DK-ERTEC 200 PN IO)
- Example project for S7-319F (for PROFIBUS DP/PA development package and DK-ERTEC 200 PN IO)
- GSD tools (e.g. GSD editor and CRC calculation tool)
- iPar server software and instructions (FB24)
- Tool calling interface example and instructions
- F programming guidelines
- Layer stacks (V1SL and PN IO)
- Example firmware (for PROFIBUS DP/PA development package and DK-ERTEC 200 PN IO)
- Project for development environment example (for PROFIBUS DP/PA development package and DK-ERTEC 200 PN IO)
- Slow motion monitor (for PROFIBUS: PG-PC and CP5613, for PROFINET: PG-CP1616)
- Comprehensive documentation

PROFIBUS

PROFIBUS Components

Development kits

Ordering data	Article No.
DP/PA development kit For PROFIBUS ASIC DPC 31 and SIM1, English/German	6ES7195-3BA10-0YA0
PROFIsafe starter kit V3.4	6ES7195-3BF02-0YA0

More information

Brochures

Information material for downloading can be found in the Internet:

<http://www.siemens.com/simatic/printmaterial>

Manuals

Manuals for PROFIBUS DP connections are available free in the Internet.

Support

Please contact the following Competence Centers for any technical questions:

Germany and Europe

Siemens AG
 Communication, Development & Certification (ComDeC)
 PO Box 23555
 90713 Fürth, Germany
 Tel.: +49 (911) 750-2080
 Fax: +49 (911) 750-2100
 E-mail: comdec@siemens.com

USA and International

PROFI Interface Center (PIC)
 One Internet Piazza
 PO Box 4991
 Johnson City, TN 37602-4991
 Tel.: +1 (423) - 262 - 2969
 Fax: +1 (423) - 262 - 2103
 E-mail: profibus.sea@siemens.com