

SIEMENS

SIMATIC HMI

HMI devices Mobile Panels 2nd Generation

Operating Instructions





<u>Preface</u>	
<u>Overview</u>	1
<u>Safety instructions</u>	2
<u>Installing system components</u>	3
<u>Handling the Mobile Panel</u>	4
<u>Parameterizing the Mobile Panel</u>	5
<u>Configuring the Mobile Panel</u>	6
<u>Commissioning a project</u>	7
<u>Operating a project</u>	8
<u>Fail-safe operation</u>	9
<u>Maintenance and care</u>	10
<u>Technical specifications</u>	11
<u>Technical Support</u>	A
<u>Markings and symbols</u>	B
<u>List of abbreviations</u>	C

Legal information

Warning notice system

This manual contains notices you have to observe in order to ensure your personal safety, as well as to prevent damage to property. The notices referring to your personal safety are highlighted in the manual by a safety alert symbol, notices referring only to property damage have no safety alert symbol. These notices shown below are graded according to the degree of danger.

 DANGER
indicates that death or severe personal injury will result if proper precautions are not taken.
 WARNING
indicates that death or severe personal injury may result if proper precautions are not taken.
 CAUTION
indicates that minor personal injury can result if proper precautions are not taken.
NOTICE
indicates that property damage can result if proper precautions are not taken.

If more than one degree of danger is present, the warning notice representing the highest degree of danger will be used. A notice warning of injury to persons with a safety alert symbol may also include a warning relating to property damage.

Qualified Personnel

The product/system described in this documentation may be operated only by **personnel qualified** for the specific task in accordance with the relevant documentation, in particular its warning notices and safety instructions. Qualified personnel are those who, based on their training and experience, are capable of identifying risks and avoiding potential hazards when working with these products/systems.

Proper use of Siemens products

Note the following:

 WARNING
Siemens products may only be used for the applications described in the catalog and in the relevant technical documentation. If products and components from other manufacturers are used, these must be recommended or approved by Siemens. Proper transport, storage, installation, assembly, commissioning, operation and maintenance are required to ensure that the products operate safely and without any problems. The permissible ambient conditions must be complied with. The information in the relevant documentation must be observed.

Trademarks

All names identified by ® are registered trademarks of Siemens AG. The remaining trademarks in this publication may be trademarks whose use by third parties for their own purposes could violate the rights of the owner.

Disclaimer of Liability

We have reviewed the contents of this publication to ensure consistency with the hardware and software described. Since variance cannot be precluded entirely, we cannot guarantee full consistency. However, the information in this publication is reviewed regularly and any necessary corrections are included in subsequent editions.

Preface

Purpose of the operating instructions

These operating instructions contain information on place of use, transport, storage, mounting, use and maintenance of the device.

These operating instructions are intended for:

- Users
- Commissioning engineers
- Maintenance personnel

You can find more information such as operating instructions, examples and reference information in the information system of the TIA Portal or through online support.

Basic knowledge required

General knowledge of automation technology and process communication is needed to understand the operating instructions. Knowledge of personal computers and the Microsoft operating systems is required to understand this manual.

Scope of the document

The operating instructions apply to the following Mobile Panels 2nd Generation in combination with the corresponding connection boxes:

- SIMATIC HMI KTP400F Mobile, article number 6AV2125-2DB23-0AX0
- SIMATIC HMI KTP700 Mobile, article number 6AV2125-2GB03-0AX0
- SIMATIC HMI KTP700F Mobile, article number 6AV2125-2GB23-0AX0
- SIMATIC HMI KTP900 Mobile, article number 6AV2125-2JB03-0AX0
- SIMATIC HMI KTP900F Mobile, article number 6AV2125-2JB23-0AX0

The corresponding connection boxes with article numbers and information on compatibility can be found in the following sections:

- Connection boxes (Page 18)
- Mobile Panel and connection box compatibility (Page 29)

The document applies in conjunction with the software listed in "Software required (Page 24)".

Note

This document is part of the Mobile Panel system, connecting cable and connection box, and is also required for repeat commissioning. Keep all supplied and supplementary documentation for the entire service life of the Mobile Panel.

Provide any future owner or user with all the documents for the HMI device.

Make sure that every supplement to the documentation that you receive is stored together with the operating instructions.

Style conventions

Style Convention	Scope
"Add screen"	<ul style="list-style-type: none">• Terminology that appears in the user interface, for example, dialog names, tabs, buttons, menu commands• Necessary entries, for example, limit, tag value• Path information
"File > Edit"	Operational sequences, e.g, menu command, shortcut menu command
<F1>, <Alt+P>	Keyboard operation

Please observe notes labeled as follows:

Note

A note contains important information about the product described in the document and its handling, or a specific section of the document to which you should pay particular attention.

Naming conventions

Term	Applies to
Control cabinet	Mounted cabinet, enclosure, terminal box, panel, control panel
Plant	System, machining center, one or more machines
F-system	Fail-safe automation system with fail-safe Mobile Panel
Connection box	<ul style="list-style-type: none"> • Connection box compact • Connection box standard • Connection box advanced
HMI device Mobile Panel	<ul style="list-style-type: none"> • KTP400F Mobile • KTP700 Mobile • KTP700F Mobile • KTP900 Mobile • KTP900F Mobile
Fail-safe Mobile Panel	<ul style="list-style-type: none"> • KTP400F Mobile • KTP700F Mobile • KTP900F Mobile
Safety-related operator control	<ul style="list-style-type: none"> • Emergency stop / stop button • Enabling button
Storage medium	<ul style="list-style-type: none"> • SD memory card • USB flash drive
WinCC	<ul style="list-style-type: none"> • WinCC Comfort V13 SP1 or higher • WinCC Advanced V13 SP1 or higher
STEP 7	STEP 7 V13 SP1 or higher
Safety optional package	STEP 7 Safety Advanced V13 SP1 or later optional package

Information on standards

You can find detailed information on standards including year of publication and corresponding supplements in the section "Standards on operating safety (Page 221)".

Standards and supplements will be referenced in the remainder of the document without citation of the year of publication, for example, "EN 61000-6-4 +A1".

Figures

This document contains figures of the devices described. The figures can deviate from the particularities of the delivered device.

Picture components are marked with black position numbers on a white background ①, ②, ③, etc.

Steps in the figures are identified with white process numbers on a black background according to the sequence in which they have to be executed: ❶, ❷, ❸, ...

See also

Terms for fail-safe operation (Page 24)

Table of contents

	Preface	3
1	Overview.....	13
1.1	Product overview	13
1.2	Design of the Mobile Panels	14
1.3	KTP Mobile connecting cable	17
1.4	Connection boxes	18
1.5	Scope of delivery	20
1.6	Accessories.....	21
1.6.1	KTP Mobile wall-mounting bracket	21
1.6.2	Fail-safe KTP Mobile spare key	22
1.6.3	Protective films.....	22
1.6.4	Storage media.....	22
1.6.5	SIRIUS safety relays.....	23
1.7	Software required.....	24
1.8	Terms for fail-safe operation.....	24
1.9	Organizational measures	28
1.10	Mobile Panel and connection box compatibility	29
2	Safety instructions.....	31
2.1	General safety instructions	31
2.2	Security management for HMI devices.....	36
2.3	Data protection.....	36
2.4	Notes about usage.....	37
2.5	Risk assessment of the plant.....	38
2.6	Important information on emergency stop / stop button	39
2.7	Important notes for the enabling mechanism	40
3	Installing system components	43
3.1	Checking the delivery.....	43
3.2	Mounting the connection box compact	43
3.2.1	Mounting position, mounting cutout and clearance	43
3.2.2	Fastening the connection box compact	45
3.3	Installing the connection box standard and connection box advanced	45
3.3.1	Mounting position and clearance	45
3.3.2	Fastening the connection box standard and connection box advanced.....	46

3.4	Attaching the KTP Mobile wall-mounting bracket	47
3.4.1	Assembling the KTP Mobile wall-mounting bracket.....	47
3.4.2	Mounting position and clearance	48
3.4.3	Fasteneing the KTP Mobile wall-mounting bracket	50
3.5	Connecting the Mobile Panel	51
3.5.1	Connection information	51
3.5.2	Inserting the SD memory card	51
3.5.3	Connecting the Mobile Panel connecting cable.....	53
3.5.4	Connecting a Configuring PC	54
3.5.5	Replacing the connecting cable	55
3.5.6	Replacing an SD memory card.....	57
3.5.7	Inserting the USB memory stick.....	58
3.6	Connecting the connection box.....	59
3.6.1	Connection information	59
3.6.2	Opening and closing connection box standard and connection box advanced.....	60
3.6.3	Equipotential bonding of connection boxes	62
3.6.4	Connecting the functional grounding and power supply to the connection box	64
3.6.5	Connecting cables for a hardwired F-system	66
3.6.6	Connecting Ethernet to the connection box.....	67
3.6.7	Setting the box ID of the connection box	70
3.6.8	Secure cables and seal screw glands	72
3.7	Connecting the KTP Mobile connecting cable to the connection box.....	73
3.8	Selecting the connection box.....	75
4	Handling the Mobile Panel	77
4.1	Holding the Mobile Panel and attaching it to the wall-mounting bracket	77
4.2	Keyswitches, function keys and illuminated pushbuttons.....	79
4.3	Operating the enabling button.....	81
4.4	Pressing the emergency stop / stop button	83
4.5	Testing Mobile Panel readiness for operation	85
5	Parameterizing the Mobile Panel.....	87
5.1	Firmware and software	87
5.2	Desktop and Start Center	87
5.3	Operating the desktop, Start Center and Control Panel	88
5.4	Installed programs	88
5.5	Security mode	89
5.5.1	Overview	89
5.5.2	Using the HMI device in password-protected security mode.....	89
5.6	Control Panel	90
5.6.1	Opening the settings	90
5.6.2	Overview of functions.....	91
5.6.3	Operating the Control Panel	93
5.6.4	Display types for the screen keyboard.....	93

5.7	Configuring operation.....	96
5.7.1	Changing display brightness.....	96
5.7.2	Configuring the screen keyboard.....	97
5.7.3	Setting the character repeat rate of the screen keyboard.....	98
5.7.4	Setting the double-click.....	99
5.7.5	Calibrating the touch screen.....	100
5.7.6	Restarting the HMI device.....	101
5.8	General settings.....	103
5.8.1	Regional and language settings.....	103
5.8.2	Setting the date and time.....	104
5.8.3	Entering and deleting a password.....	105
5.8.4	Setting the screen saver.....	107
5.8.5	Parameterizing Transfer.....	109
5.8.6	Storage management.....	111
5.8.6.1	Displaying the memory distribution.....	111
5.8.6.2	Setting the project storage location and start delay.....	111
5.8.6.3	Activating memory management.....	113
5.8.6.4	Activate/deactivate retentivity of the alarm buffer on the HMI device.....	113
5.8.7	Backing up registry information and temporary data.....	115
5.8.8	Changing the print options.....	116
5.8.9	Displaying general system properties.....	117
5.8.10	Displaying information about the Mobile Panel.....	118
5.8.11	Display firmware.....	118
5.9	Changing Internet settings.....	119
5.9.1	Changing general settings.....	119
5.9.2	Setting the proxy server.....	120
5.9.3	Changing Internet security settings.....	121
5.9.4	Activating encryption protocols.....	123
5.9.5	Importing, displaying and deleting certificates.....	124
5.10	Enabling PROFINET.....	126
5.11	Enabling NTP.....	127
5.12	Setting the PROFIsafe address.....	129
5.13	Configuring network operation.....	130
5.13.1	Overview.....	130
5.13.2	Specifying the computer name of the HMI device.....	131
5.13.3	Specifying the IP address and name server.....	132
5.13.4	Specifying the logon data.....	133
5.13.5	Configuring e-mail.....	134
5.13.6	Configuring Telnet for remote control.....	136
5.13.7	Configure Sm@rt Server.....	136
5.13.8	Configure Web Server.....	140
5.14	Assigning a safety-related operating mode.....	142
5.15	Functions for service and commissioning.....	144
5.15.1	Saving to external storage medium – backup.....	144
5.15.2	Restoring from external storage medium – Restore.....	147
5.15.3	Update operating system.....	149
5.15.4	Load project from external storage medium.....	152
5.15.5	Using automatic backup.....	155

5.15.6	Editing IP addresses and communication connections	159
5.15.6.1	Overview	159
5.15.6.2	Assigning IP address and device name.....	160
5.15.6.3	Configuring a communication connection	162
6	Configuring the Mobile Panel	165
6.1	Configuration in WinCC	167
6.1.1	Adding a controller to the project	167
6.1.2	Adding the Mobile Panel to the project	169
6.1.3	Configuring a fail-safe Mobile Panel	170
6.2	Configuring F-FBs in STEP 7.....	174
6.3	Configuring plant areas in WinCC.....	179
6.3.1	Overview	179
6.3.2	Configuring connection point detection.....	179
6.3.3	Configuring zones and start screens	181
6.4	Additional configuration options in WinCC.....	182
6.4.1	Configuring function and direct keys.....	182
6.4.2	Setting the transfer mode.....	183
6.4.3	Changing the operating mode.....	183
6.5	Controlling and evaluating operator controls and display elements	184
6.5.1	Overview	184
6.5.2	Evaluating operator controls as direct keys	184
6.5.3	Controlling the LEDs of the function keys by means of system functions	187
6.5.4	Controlling and evaluating the illuminated pushbutton by means of system functions	187
6.5.5	Evaluating the key-operated switch by means of system functions	188
7	Commissioning a project.....	189
7.1	Overview	189
7.2	Using existing projects	190
7.3	Data Transmission Options.....	190
7.4	Transferring a project with WinCC	191
7.4.1	Configuring data channel and setting transfer mode	191
7.4.2	Starting the transfer	191
7.4.3	Testing a project.....	193
7.5	Backup and restore	194
7.5.1	Backup and restore with a PC	194
7.5.2	Backup and restore with an external storage medium.....	194
7.5.3	Backup and restore via ProSave	194
7.6	Updating the operating system using ProSave.....	196
7.7	Reset to factory settings with ProSave	198
7.8	Managing WinCC options	200
7.9	Transferring a license key	201
8	Operating a project	203
8.1	Overview	203
8.2	Function keys	204

8.3	Direct keys	205
8.4	Setting the project language	205
8.5	Entering and modifying the value, date and time	206
8.6	Displaying infotext	207
8.7	Closing the project	208
9	Fail-safe operation	209
9.1	Connecting the connecting cable	209
9.2	Unplugging the connecting cable	211
9.3	Safety-related dialogs	212
9.3.1	"End PROFIsafe communication" dialog	212
9.3.2	"Confirm communication error" dialog	213
9.3.3	"Fatal Error" dialog	213
10	Maintenance and care	215
10.1	General information on maintenance and servicing	215
10.2	Replacing the Mobile Panel	215
10.3	Servicing the Mobile Panel	216
10.4	Cleaning the Mobile Panel	217
10.5	Spare parts and repairs	218
10.6	Recycling and disposal	218
11	Technical specifications	219
11.1	Software license agreements	219
11.2	Certificates and approvals	219
11.3	Standards on operating safety	221
11.4	Electromagnetic compatibility	221
11.5	Mechanical ambient conditions	223
11.5.1	Storage conditions	223
11.5.2	Operating Conditions	223
11.6	Climatic ambient conditions	224
11.6.1	Long-term storage	224
11.6.2	Transport and short-term storage	224
11.6.3	Operating Conditions	224
11.7	Dimension drawings	225
11.7.1	KTP400F Mobile dimension drawing	225
11.7.2	KTP700 Mobile dimension drawing	226
11.7.3	KTP700F Mobile dimension drawing	227
11.7.4	KTP900 Mobile dimension drawing	228
11.7.5	KTP900F Mobile dimension drawing	229
11.7.6	Connection box compact dimension drawing	230
11.7.7	Dimension drawing for connection box standard and connection box advanced	231
11.7.8	KTP Mobile wall-mounting bracket dimension drawing	232

11.8	Technical specifications	233
11.8.1	Mobile Panel	233
11.8.2	Connecting cable	235
11.8.3	Connection boxes	236
11.8.4	Power consumption specifications	238
11.8.5	Reaction times and safety characteristics for fail-safe operation	239
11.8.6	Specification of cables to be used	242
11.9	Interface description for Mobile Panel	243
11.9.1	Internal interface X1P1	243
11.9.2	Internal interface X80	243
11.9.3	External interface X61	243
11.10	Connection box compact interfaces	244
11.10.1	Position of the interfaces	244
11.10.2	Interface X1	244
11.10.3	Plug-in terminal strip X10	245
11.10.4	Wiring of safety-related operator controls	246
11.11	Interfaces of the connection box standard and connection box advanced	248
11.11.1	Position of the interfaces	248
11.11.2	Fast connector X1 and X2	249
11.11.3	Plug-in terminal strip X10	249
11.11.4	Wiring of safety-related operator controls	250
11.12	Communication with controllers	253
11.13	Scope of functions with WinCC	254
11.14	Mobile Panel 2nd Generation F-FBs	258
11.14.1	Using F-FBs	258
11.14.2	F_FB_KTP_Mobile	260
11.14.3	F_FB_KTP_RNG	263
A	Technical Support	267
A.1	Troubleshooting	267
A.2	Service and support	268
A.3	Parameterization of the connection box standard and connection box advanced	269
A.4	System events	269
B	Markings and symbols	271
B.1	Safety-relevant symbols	271
C	List of abbreviations	273
	Glossary	275
	Index	281

Overview

1.1 Product overview

The second generation of SIMATIC HMI Mobile Panels offers direct mobile operation and monitoring of the production process. The Mobile Panels 2nd Generation system consists of a Mobile Panel, connection box and connecting cable.

The Mobile Panels 2nd Generation is available with display sizes 4", 7" and 9" widescreen.

The figure below shows a fail-safe Mobile Panel with a 7" widescreen display connected to a connection box advanced.



Depending on the application, either non-fail-safe or fail-safe Mobile Panels can be used. With a fail-safe Mobile Panel, you run the plant in fail-safe mode. You meet the requirements of Safety Integrity Level 3 and Performance Level PL e with a fail-safe Mobile Panel. An emergency stop / stop switch and an enabling button are integrated in a fail-safe Mobile Panel 2nd Generation. You can hardwire the safety-related operator controls or evaluate them in a PROFIsafe-based F-system with a fail-safe controller.

The 7" and 9" devices come equipped with a keyswitch as additional option for protecting the HMI device from unauthorized access.

You can choose from three connection boxes each with a different range of functions. The connection box compact is designed for installation in control cabinets. The connection box standard and connection box advanced are approved for external mounting directly on the machine.

The device is designed for industrial use:

- High fall resistance
- High protection class
- High impact resistance
- High chemical resistance to operating and cleaning agents (<http://support.automation.siemens.com/WW/view/en/39718396>).

The enclosure type protects the emergency stop / stop button. Two protective bumpers to prevent damage to the emergency stop / stop button during a fall of the HMI device.

All Mobile Panels can be configured with the WinCC software. WinCC is a component of the "Totally Integrated Automation Portal" engineering framework.

1.2 Design of the Mobile Panels

The Mobile Panels 2nd Generation are available in the following device versions:

SIMATIC HMI	Number of function keys	Illuminated pushbutton	Emergency stop / stop button, acknowledgment button	Keyswitch
KTP400F Mobile	4	2	Yes	No
KTP700 Mobile	8	2	No	No
KTP700F Mobile	8	2	Yes	Yes
KTP900 Mobile	10	2	No	No
KTP900F Mobile	10	2	Yes	Yes

Note

System components

To operate a Mobile Panel, you need:

- An HMI device
- A connecting cable (Page 17)
- At least one connection box (Page 18)
- For hardwired F-systems: A safety relay (Page 23) or suitable F-DI modules.

You can find the ordering information for the system components on the Internet (<https://mall.industry.siemens.com/mall/en/de/Catalog/Products/10165537>).

Front and side views

The figures below show an example of the design of the fail-safe HMI device, KTP900F Mobile. The other HMI devices of the type KTP Mobile are constructed similarly.



- ① Keyswitch, only for KTP700F Mobile and KTP900F Mobile
- ② Enabling button, for fail-safe Mobile Panel
- ③ Emergency stop / stop switch for fail-safe Mobile Panel
- ④ Drop protection for emergency stop / stop switch for fail-safe Mobile Panel
- ⑤ Cover of the USB port
- ⑥ Handle
- ⑦ Function key blocks
- ⑧ Display with touch screen
- ⑨ Illuminated pushbutton

The position of the emergency stop/stop button makes it easily accessible. Due to its profiled design, the emergency stop/stop button is easily accessible. Two bumpers protect the emergency stop / stop button against impact damage, for example, if it falls. The bumpers are dimensioned so that the emergency stop / stop button can be activated during an impact.

The operator controls are described in the section "Handling the Mobile Panel (Page 77)".

Rear view and interfaces

The figure below shows an example of the design of the fail-safe HMI device, KTP900F Mobile. The other HMI devices of the type KTP Mobile are constructed similarly.

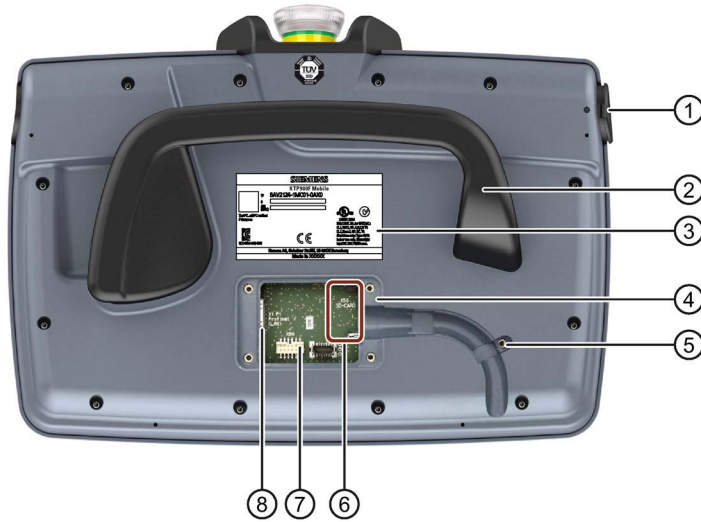

- ① USB port with cover
- ② Handle
- ③ Nameplate
- ④ Terminal compartment
- ⑤ Threaded sleeve for mounting screw of the cable retainer, not for KTP400F Mobile
- ⑥ Slot for an SD memory card, not for KTP400F Mobile
- ⑦ 12-pin connector for the connecting cable
- ⑧ RJ45 socket PROFINET (LAN)

1.3 KTP Mobile connecting cable

You connect the Mobile Panel to the connection box using the rugged connecting cable. The tensile and flexural strength of the connecting cable is geared toward the actual usage conditions.

Functions of the connecting cable:

- Power supply of the Mobile Panel
- Ethernet connection between Mobile Panel and connection box
- Transmission of the signals for emergency stop / stop button and enabling button
- Transmission of the box ID



- ① RJ45 connector
- ② Plug connector, 12-pin
- ③ Retainer, not required for KTP400F Mobile.
- ④ Label with order number, length specification and product version
- ⑤ Seal
- ⑥ Terminal compartment cover
- ⑦ Connector for the connection box

The KTP Mobile connecting cable is available in the following lengths:

Product name and length	Article number
KTP Mobile 2 m connecting cable	6AV2181-5AF02-0AX0
KTP Mobile 5 m connecting cable	6AV2181-5AF05-0AX0
KTP Mobile 8 m connecting cable	6AV2181-5AF08-0AX0
KTP Mobile 10 m connecting cable	6AV2181-5AF10-0AX0
KTP Mobile 15 m connecting cable	6AV2181-5AF15-0AX0
KTP Mobile 20 m connecting cable	6AV2181-5AF20-0AX0
KTP Mobile 25m connecting cable	6AV2181-5AF25-0AX0

1.4 Connection boxes

The connection boxes are available in the following versions:

- Connection box compact, article number 6AV2125-2AE03-0AX0
- Connection box standard, article number 6AV2125-2AE13-0AX0
- Connection box advanced, article number 6AV2125-2AE23-0AX0

Connection box compact

The figure below shows the connection box compact.

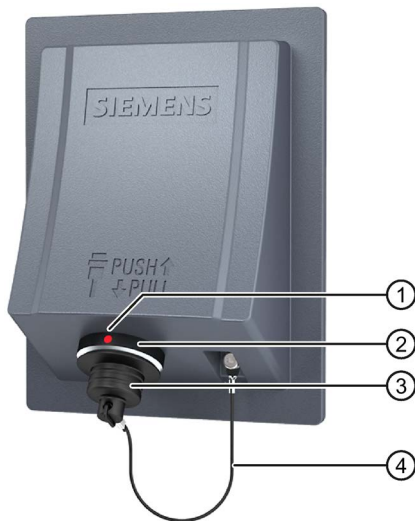

- ① Positioning mark
There is also a red positioning mark on the connecting cable. Align this mark with the positioning mark on the connection box when connecting.
- ② Connection socket for the connecting cable
- ③ Cover of the connection socket
- ④ Safety strap

Connection box standard and connection box advanced

The figure below shows the connection box standard or the connection box advanced. The connection box advanced also features:

- Real-time Ethernet
- F-signal transmission

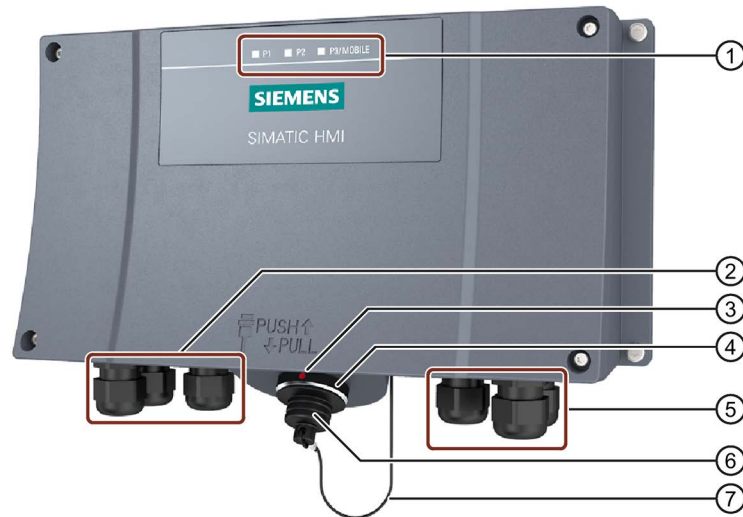

- ① LED display
- ② Screw glands for the data cables
- ③ Positioning mark
There is also a red positioning mark on the connecting cable. Align this mark with the positioning mark on the connection box when connecting.
- ④ Connection socket for the connecting cable
- ⑤ Screw glands for power supply cables and F-signal cables
- ⑥ Cover of the connection socket
- ⑦ Safety strap

There are three LEDs on the front of the connection box that indicate the status of communication.

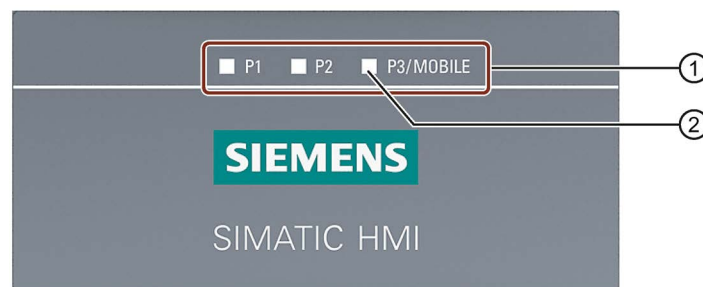

- ① LED display of the three Ethernet ports:
 - P1: Fast Connector X1
 - P2: Fast Connector X2
 - P3: Connection socket for the Mobile Panel
- ② LED

Basic functions of the LEDs:

- LED lit green: Link established, no data transmission
- LED flashes green or amber: Link established, data transfer in progress

You can find information about other possible LED states in the following document:

Operating instructions "SCALANCE X-200"

(<https://support.industry.siemens.com/cs/ww/en/view/102051962>)

See also

Connecting the connection box (Page 59)

1.5 Scope of delivery

This section describes the system components in the scope of delivery that you need for operating a Mobile Panel 2nd Generation.

Mobile Panel 2nd Generation:

- 1 Mobile Panel or fail-safe Mobile Panel
- 1 DVD with documentation and product information
- 1 "Mobile Panels 2nd Generation" Quick Install Guide

The scope of delivery may contain additional documents.

Connection box compact:

- 1 Connection box compact
- 1 DVD with documentation and product information
- 1 Accessory kit with mounting clips
- 1 Installation instruction

The scope of delivery may contain additional documents.

Connection box standard and connection box advanced:

- 1 Connection box
- 1 DVD with documentation and product information
- 1 Installation instruction

The scope of delivery may contain additional documents.

Connecting cable:

- 1 Connecting cable with terminal compartment cover with four screws
- 1 Cable retainer with screw

1.6 Accessories

Accessories are not included in the scope of delivery but can be ordered from the following address:

HMI accessories

(<https://mall.industry.siemens.com/mall/en/WW/Catalog/Products/10144445>)

In the Industry Mall you can find the following accessories for the HMI devices of type KTP Mobile, for example:

- KTP Mobile wall-mounting bracket
- KTP Mobile spare key
- Memory card
- Protective film

1.6.1 KTP Mobile wall-mounting bracket

The wall-mounting bracket holds the Mobile Panel securely in place during stationary operation.

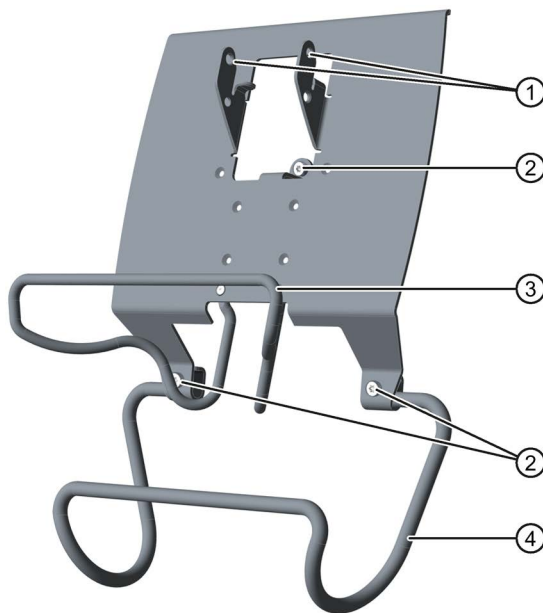

- ① Hooks for the handle on the Mobile Panel
- ② Screw flange
- ③ Safety bar for the Mobile Panel
- ④ Holding bracket for the connecting cable

The assembly of the KTP Mobile wall-mounting bracket is described in the section "Assembling the KTP Mobile wall-mounting bracket (Page 47)".

1.6.2 Fail-safe KTP Mobile spare key

The KTP Mobile spare key is part of the keyswitch for the fail-safe Mobile Panel 2nd Generation. See section "Keyswitches, function keys and illuminated pushbuttons (Page 79)".

1.6.3 Protective films

The protective film prevents the touch screen from getting scratched and dirty during operation. One set of protective film contains 10 protective films.

- Protective film 4" touch devices, type 13
- Protective film 7" touch devices, type 13
- Protective film 9" touch devices, type 13

1.6.4 Storage media

You can use the storage media to back up Mobile Panel data and copy data to the Mobile Panel. Use the following storage media:

- SIMATIC HMI Memory Card
Siemens AG has approved the use of SD memory cards in the Mobile Panel.
- USB flash drive
The USB flash drive must be suitable for industrial applications. The storage medium is inserted in the port on the left of the device.

1.6.5 SIRIUS safety relays

If you are using a fail-safe Mobile Panel in a hardwired F system, you must use a safety relay.

The Mobile Panels 2nd Generation have been tested with the following safety relays and approved:

- SIRIUS safety relay, standard, relay output
article number 3SK1111-1AB30
- SIRIUS safety relay, standard, electronic output
article number 3SK1112-1BB40
- SIRIUS safety relay, advanced, relay output
article number 3SK1121-1AB40
- SIRIUS safety relay, advanced, electronic output
article number 3SK1122-1AB40

You can find the complete portfolio of the SIRIUS 3SK safety relays on the Internet (<http://www.siemens.com/product?3SK>).

Note

Evaluation of the safety-related operator controls via F-DI modules

Instead of a SIRIUS safety relay, F-DI modules can be used for the evaluation. The F-DI modules used must be appropriate for the required safety integrity level SIL/performance level and category. Depending on the safety integrity level SIL/performance level and category required, the following functions are, for example, to be used for the F-DI modules:

- Short- and cross-circuit monitoring
- Discrepancy monitoring
- Short-circuit detection
- Cross-circuit detection

The plant operator/system engineer is responsible for checking the proper functioning of the hardwired F-system with evaluation of the safety-related operator controls via one or more F-DI modules.

See also

FAQs Mobile Panels 2nd Generation
(<https://support.industry.siemens.com/cs/ww/en/ps/14746/faq>)

1.7 Software required

Configuration software

KTP700 Mobile, KTP700F Mobile, KTP900 Mobile, KTP900F Mobile

You need one of the following software products to configure the HMI devices:

- WinCC Comfort V13 SP1 Update 4 or higher
- WinCC Advanced V13 SP1 Update 4 or higher

To operate a fail-safe Mobile Panel in a PROFIsafe-based F-system, you need the optional package STEP 7 Safety Advanced V13 SP1 or higher.

KTP400F Mobile

You need one of the following software products to configure the KTP400F Mobile:

- WinCC Comfort V13 SP1 Update 6 or higher
- WinCC Advanced V13 SP1 Update 6 or higher

You also need the HSP0168 HMI KTP400F Mobile V1.0 or higher.

To operate a KTP400F Mobile in a PROFIsafe-based F-system, you need the optional package STEP 7 Safety Advanced V13 SP1 or higher.

See also

Configuring a fail-safe Mobile Panel (Page 170)

1.8 Terms for fail-safe operation

This section defines terms relating to fail-safe operation with a fail-safe HMI device.

You can find additional information on the topic of "Safety" in the following document: "SIMATIC Safety - Configuring and Programming" programming and operating manual (<http://support.automation.siemens.com/WW/view/en/54110126>)

Fail-safe automation system, F system

A fail-safe automation system is required in a plant with high safety requirements. An F-system is characterized by the following features:

- Safety-related shutdown response of the system after the triggering of a stop or emergency stop via a safety-related operator control.
- The confirmation of machine movements entailing danger via an enabling mechanism.

The following F-systems in conjunction with a fail-safe Mobile Panel are distinguished in this document:

- Hardwired F-system: The safety-related operator controls are wired to a safety relay. If one of the safety-related operator controls is activated, the safety relay triggers the safe state or confirms a machine movement entailing danger in the F-system via the enabling button.
- PROFIsafe-based F-system: The signals of the safety-related operator controls are transmitted to the F-system via PROFIsafe.

Safety-related devices with fail-safe controllers communicate with PROFIsafe via PROFINET to enable these devices to be used in fail-safe automation systems up to SIL3. PROFIsafe implements safety-related communication with a special user data format and a special protocol. PROFIsafe is specified for PROFINET in the standard IEC 61784-3.

Safe operating state

If an unexpected event occurs during plant operation that poses a risk to persons or equipment, the plant must respond with a defined safety shutdown. Protection of personnel against physical injury can only be ensured if intervention in manufacturing processes, for example during retrofitting or troubleshooting, is safe and secure.

Based on the risk analysis, the safety shutdown and therefore the shutdown response of the plant must therefore be configured to ensure that the plant or plant area can be switched to a safe operating state in the event of a risk.

In addition to the qualitative risk analysis required, the machine operator also has an obligation to make a quantitative assessment of potential hazards. On this basis, the operator must then establish what risks could arise during plant or plant area operation and whether the relevant safety functions are sufficiently effective for the hazard in question.

The safe operating state is assigned to the fail-safe controller by a safety program. The plant constructor is responsible for the required configuration which should be described in the plant documentation.

Safety-related operator controls

A fail-safe Mobile Panel comes equipped with the two safety-related operator controls "Emergency stop / stop button" and "Acknowledgment button". All other operator controls are not safety-related operator controls.

Fail-safe operation

In a hardwired or PROFIsafe-based F-system, you operate the plant or a plant section in fail-safe mode. In fail-safe mode, the safety-related operator controls emergency stop/stop button and enabling buttons are active.

- For a hardwired F-system: Fail-safe mode runs via a fixed connection with a safety relay.
- In a PROFIsafe-based F-system: The HMI device in fail-safe mode detects the signals of the "emergency stop / stop button" and "enabling button" safety-related operator controls; communication with the F-system is performed via PROFIsafe.

When configuring the safety functions with the STEP 7 Safety Advanced optional package, fail-safe operation according to SIL 3 or Performance Level e and Category 4 is possible with an HMI device of the type KTPx00F Mobile.

The safety-related operator controls can be configured as fail-safe inputs in the safety program.

Emergency stop, stop

The operator presses the emergency stop / stop button to activate either an emergency stop or a stop.

- The emergency stop is an emergency action that is intended to stop a process or movement entailing danger. All machines that are assigned to the trigger are immediately brought to a safe state via the emergency stop.
- The emergency stop / stop button of the HMI device brings about a safety-related stop of the plant or machine in accordance with EN 60204-1, Section 9.2.5.3.

Whether the emergency stop / stop button causes an "emergency stop" or "stop" function must be decided upon and configured on the basis of the risk assessment.

Safety-related operating mode

In fail-safe mode, you can use the HMI device in combination with a connection box in one of the following operating modes:

- **Stop button evaluated by safety relay**
This operating mode is intended for a hardwired F-system. The signals of the safety-related operator controls are wired to a safety relay. If you press the emergency stop / stop button, the plant typically responds with a stop. The emergency stop / stop button does not light up. In this operating mode, the emergency stop / stop button is called the **stop button**.
- **E-stop button evaluated by safety relay**
This operating mode is intended for a hardwired F-system. The signals of the safety-related operator controls are wired to a safety relay. When you press the emergency stop / stop button, the plant responds with an emergency stop. The emergency stop / stop button lights up when active. In this operating mode, the emergency stop / stop button is called the **emergency stop button**.
- **E-stop button evaluated by PROFIsafe**
This operating mode is intended for a PROFIsafe-based F-system. If you press the emergency stop / stop button, an emergency stop is triggered in the plant. The emergency stop / stop button lights up when active, that is, if the HMI device has been registered in the safety program. In this operating mode, the emergency stop / stop button is called the **emergency stop button**.

Emergency stop / stop bypass

The emergency stop / stop bypass is a function of the connection box advanced for hardwired F-systems.

The function ensures that no stop or emergency stop will be triggered in the plant when reconnecting the Mobile Panel to another connection box.

PROFIsafe communication, logon and logoff in the safety program

The following applies in a PROFIsafe-based F-system for the logon and logoff of the fail-safe Mobile Panel to a safety program:

Mobile Panel logon

If you have connected the fail-safe HMI device with a connection box and started the HMI project, the HMI device is automatically logged onto the safety program. After logon, the fail-safe HMI device is integrated into PROFIsafe communication and the emergency stop button and enabling button become active.

Mobile Panel logoff

Before disconnecting the fail-safe HMI device from a connection box, you must log off the HMI device using an appropriate operator control of the safety program or close the current project. Logoff must be confirmed in a dialog. When you log off, the HMI device is removed from PROFIsafe communication. After logging off, the emergency stop button and enabling button are no longer active. You can therefore disconnect the HMI device from the connection box.

For the HMI devices KTP700F Mobile and KTP900F Mobile: If you logged off the HMI device without closing the project from the safety program, the project remains active on the HMI device for the duration of the backup time and you can plug the HMI device into another connection box. After plugging into another connection box and automatic logon to the safety program, you can continue working with the current project in fail-safe mode.

If you disconnect the fail-safe Mobile Panel without logging off the connection box, a PROFIsafe communication error occurs and the plant goes into safe operating mode according to the configured shutdown behavior.

Connection point recognition

The connection point recognition is a function that you can configure for connection boxes. Once you have configured connection point recognition, you can determine the plant area in which an HMI device is connected and the connection box used for this. This provides the following functions, for example:

- Display of screens on the HMI device for specific plant areas
- Emergency stop / stop for specific plant areas

1.9 Organizational measures

Measures

If you are using a fail-safe Mobile Panel in a fail-safe system, you must consider the following organizational measures:

- Install stationary emergency stop or emergency off buttons in the plant that are effective independent of the Mobile Panel.
- Perform a risk assessment of the plant.
- If the overall plant is not to be monitored from a single location, configure plant areas.
- Select the same operating mode for all connection boxes in a contiguous plant area.
- Create a safety program.
- Run an acceptance test on the fail-safe automation system.

F-systems

The table below shows the F-systems that can be configured or installed for a given connection box. Requirement is that you are using a fail-safe Mobile Panel.

Connection box	PROFIsafe-based F-system	Hardwired F-system, no emergency stop/stop bypass	Hardwired F-system with emergency stop/stop bypass
compact	Yes	Yes	No
standard	Yes	Yes	No
advanced	Yes	No	Yes
Safety-related operating mode	E-stop button evaluated by PROFIsafe	Stop button evaluated by safety relay	Stop button evaluated by safety relay
		E-stop button evaluated by safety relay	E-stop button evaluated by safety relay

1.10 Mobile Panel and connection box compatibility

This section addresses the following compatibility:

- Compatibility of Mobile Panels 2nd Generation to connection box PN Basic and PN Plus
- Compatibility of Mobile Panels 1st Generation to connection boxes compact, standard und advanced

The Mobile Panels 2nd Generation are not compatible with the connection box DP Basic and connection box DP Plus.

Compatibility of Mobile Panels 2nd Generation – connection box PN Basic and PN Plus

The 2nd Generation Mobile Panels are compatible with the following connection boxes:

- Connection box PN Basic, article number 6AV6671-5AE01-0AX0
- Connection box PN Plus, article number 6AV6671-5AE11-0AX0

Restrictions:

- Only one hardwired F-system with a stop function and enabling function is permitted.
- PROFINET communication is possible with the connection boxes PN Basic and PN Plus, a PROFIsafe -based F-system is not feasible.
- Note the reduced maximum permissible amperage for the acknowledgment button circuit in the technical specifications, section "Connection boxes (Page 236)".

Compatibility of Mobile Panels 1st Generation – connection boxes of the Mobile Panel 2nd Generation

You can use the connection box compact, the connection box standard and the connection box advanced with the following predecessor devices:

- Mobile Panel 177 PN
Article numbers 6AV6645-0BA01-0AX0, 6AV6645-0BB01-0AX0, 6AV6645-0BC01-0AX0
- Mobile Panel 277 8"
Article numbers 6AV6645-0CA01-0AX0, 6AV6645-0CB01-0AX0, 6AV6645-0CC01-0AX0
- Mobile Panel 277 10"
Article number 6AV6645-0BE02-0AX0

Restrictions:

- Only one hardwired system F-system with a stop function and enabling function is permitted with a Mobile Panel 1st Generation.
- PROFIsafe communication is not possible with predecessor devices, therefore a PROFIsafe -based F-system is not feasible.
- The "Mobile Panel inserted" signal is not available on the connection boxes of the Mobile Panel 2nd Generation.
- The "Control" signal is not available on the connection boxes of the Mobile Panel 2nd Generation.

Safety instructions

2.1 General safety instructions

The device is designed for operation in industrial areas for operator control and monitoring of plant processes.

 WARNING
Personal injury or material damage due to non-compliance with safety regulations Failure to exactly comply with the safety regulations and procedures in this document can result in hazards and disable safety functions. This can result in personal injuries or material damage. Closely follow closely the safety regulations and procedural instructions in each situation.

Observe the safety and accident prevention regulations applicable to your application in addition to the safety instructions given in this document.

Safety during configuration and operational safety of the plant

 WARNING
Personal injury or material damage due to improper configuration of the plant The configuration engineer for plant control must take precautions to ensure that an interrupted program will be correctly integrated again after communication failures, voltage dips or power outages. A dangerous operating state must not be allowed to occur - not even temporarily - during the entire execution of the control program, even during a troubleshooting.

 WARNING
Programming startup protection in the safety program At a STOP/RUN transition of an F-CPU, the standard user program starts up as usual. When the safety program starts up, all FDBs are initialized with values from the load memory, same as during a cold restart. As a result, saved error information is lost. The F-system performs an automatic reintegration of the F-I/O. A startup of the safety program with values from the load memory can also be initiated by a handling error or an internal error. If the process does not permit this, a (re)start protection must be programmed in the safety program. The output of process values must be disabled until manually enabled; this must not occur until the process values can be output without posing a hazard and errors have been eliminated.

NOTICE
Exclusive operating right Operating the plant with multiple HMI devices simultaneously can cause material damage. Prevent simultaneous operation of the plant from multiple devices by configuring the assignment of operating rights to only one HMI device.

Parameter assignment fail-safe Mobile Panels

 WARNING
Personal injury or material damage with different operating modes in a plant area If you assign different operating modes to the connection boxes in a contiguous plant area, the emergency stop / stop button may light at one of the connection boxes but not at another. When the emergency stop / stop button does not light up, it is not apparent to the operator if the safety-related operator controls are active or not. This can result in personal injury or material damage due to maloperation. Only configure a single operating mode for multiple connection boxes in a contiguous plant area.

 WARNING
Do not activate Telnet service on fail-safe Mobile Panel Remote access to a fail-safe Mobile Panel via Telnet is not permissible, because undetectable, dangerous functions may be triggered through this access. This can result in personal injury or property damage. Do not activate Telnet service on a fail-safe Mobile Panel. The default setting is "deactivated".

Operational safety in the plant

WARNING

Short-term PROFINET IO interruptions possible when using protocols with alternative communication paths

The following applies when you use a protocol with alternative communication paths, for example, MRP, STP or RSTP, for PROFINET communication: When an interruption in the network occurs, for example, due to a cable break, PROFINET IO interruptions can occur during the switching time to the alternative communication path. This can result in personal injury or property damage.

Take appropriate protection measures to prevent physical injury or material damage.

You can find additional information in the following document: Configuration manual "SCALANCE X-200" (<https://support.industry.siemens.com/cs/ww/de/view/109476763>)

Note

Observe the Operational Safety and Product Monitoring newsletter.

Plants with safety-related characteristics are subject to special requirements for operational safety on the part of the operator. Vendors are also required to comply with certain measures for monitoring the product. We therefore provide a special newsletter about product development and properties to inform you about important safety aspects for the operation of plants. To ensure that you are always kept up-to-date in this regard and can make changes to your plant, you should subscribe to the appropriate newsletter.

Subscribe to the newsletter for fail-safe system components and the SIMATIC industrial software at the following link: Newsletter

(<https://www.industry.siemens.com/newsletter/public/AllNewsletters.aspx>)

To receive these newsletters, select the "News" check box.

Safety during commissioning

WARNING

The device may only be used in machines which comply with the Machinery Directive

The "Machinery Directive" governs, among other things, the precautions to be taken when commissioning and operating machines within the European Economic Area.

Failure to follow these precautions is a breach of the Machinery Directive. Such failure may also cause personal injury and damage depending on the machine operated.

The machine in which the HMI device is to be operated must conform to Directive 2006/42/EC.

Safety when working in and on electrical systems

Work in or on electrical systems may only be carried out by authorized persons. The following safety regulations apply for the prevention of electric shock and electrocution:

1. Switch off the system
2. Secure the system to prevent it switching back on
3. Check the system to ensure it is de-energized
4. Ground and short the system
5. Cover or shield adjacent live parts

Note

These safety steps must always be taken in the above order before any work on electrical systems. Once work on an electrical system is finished, cancel the safety steps starting with the last and finishing with the first.

Label the electrical system in accordance with the applicable safety provisions when work is to be carried out.

Always adhere to the safety provisions applicable in the country of use.

Strong high-frequency radiation

NOTICE
Observe immunity to RF radiation
The device has an increased immunity to RF radiation according to the specifications on electromagnetic compatibility in the technical specifications.
Radiation exposure in excess of the specified immunity limits can impair device functions, result in malfunctions and therefore injuries or damages.
Read the information on immunity to RF radiation in the technical specifications.

ESD



A device with electronic components is an electrostatic sensitive device. Due to their design, electronic components are sensitive to overvoltage and thus to the discharge of static electricity. Note the applicable regulations for ESD.

Safety during operation

 WARNING**Danger of injury**

If the HMI device is to be used for manual movements in setup mode and the enabling button is not active, there is a serious risk for the operating personnel.

For a project used to set up a plant, make sure that each movement requires the operation of the enabling button. Only allow movements with the enabling button and at a reduced speed.

 WARNING**HMI device failure**

A strong shock or impact can impair the proper functioning of the Mobile Panel.

After any mechanical shock or impact, check that the Mobile Panel and the safety-related parts are in working order.

Note

The emergency stop / stop button can be triggered unintentionally when the HMI device is dropped. This can result in an unintended shutdown of the plant.

Note

The function of the emergency stop / stop button must be checked regularly. See "Testing Mobile Panel readiness for operation (Page 85)".

Industrial Security

Siemens provides products and solutions with industrial security functions that support the secure operation of plants, systems, machines and networks.

In order to protect plants, systems, machines and networks against cyber threats, it is necessary to implement – and continuously maintain – a holistic, state-of-the-art industrial security concept. Siemens' products and solutions constitute one element of such a concept.

Customers are responsible for preventing unauthorized access to their plants, systems, machines and networks. Such systems, machines and components should only be connected to an enterprise network or the internet if and to the extent such a connection is necessary and only when appropriate security measures (e.g. firewalls and/or network segmentation) are in place.

For additional information on industrial security measures that may be implemented, please visit (<http://www.siemens.com/industrialsecurity>).

2.2 Security management for HMI devices

Siemens' products and solutions undergo continuous development to make them more secure. Siemens strongly recommends that product updates are applied as soon as they are available and that the latest product versions are used. Use of product versions that are no longer supported, and failure to apply latest updates may increase customer's exposure to cyber threats.

To stay informed about product updates, subscribe to the Siemens Industrial Security RSS Feed under (<http://www.siemens.com/industrialsecurity>).

Disclaimer for third-party software updates

This product includes third-party software. Siemens AG only provides a warranty for updates/patches of the third-party software, if these have been distributed as part of a Siemens software update service contract or officially released by Siemens AG. Otherwise, updates/patches are undertaken at your own risk. You can find more information about our Software Update Service offer on the Internet at Software Update Service (<http://www.automation.siemens.com/mcms/automation-software/en/software-update-service>).

Notes on protecting administrator accounts

A user with administrator privileges has extensive access and manipulation options in the system.

Therefore, ensure there are adequate safeguards for protecting the administrator accounts to prevent unauthorized changes. To do this, use secure passwords and a standard user account for normal operation. Other measures, such as the use of security policies, should be applied as needed.

See also

Technical support (<https://support.industry.siemens.com/cs/ww/en/>)

2.2 Security management for HMI devices

You can find additional information on security management of HMI devices on the Internet at the following address:

Panel Security Guidelines (<https://support.industry.siemens.com/cs/de/en/view/109481300>)

2.3 Data protection

Siemens observes the data protection guidelines, especially the requirements regarding data minimization (privacy by design). This means the following for this SIMATIC product: The product does not process / save any personal information, but only technical functional data (e.g. time stamps). If the user links this data to other data (e.g. shift plans) or if the user saves personal information on the same medium (e.g. hard disk) and therefore creates a personal reference in the process, the user has to ensure meeting the guidelines regarding data protection.

2.4 Notes about usage

NOTICE
HMI device approved for indoor use only The HMI device may be damaged if operated outdoors. Operate the HMI device indoors only.

Note

Operate the device only in a normal atmospheric environment

The technical characteristics of the device described in the operating instructions are guaranteed if you operate the device in normal ambient air conditions with usual air composition.

Note

The device is intended for operation in an SELV/PELV circuit according to IEC/EN 61131 or IEC/EN 61010-2-201 in a dry environment, which means a dry environment inside the building.

Additional information is available in the section "Operating Conditions (Page 224)".

Industrial applications

The HMI device is designed for industrial applications. It conforms to the following standards:

- Requirements for emitted interference EN 61000-6-4 +A1
- Requirements for interference immunity EN 61000-6-2

Use in mixed-use zone

Under certain circumstances you can use the HMI device in a mixed-use zone. A mixed-use zone is used for housing and commercial operations that do not have a significant impact on residents.

When you use the HMI device in a mixed-use zone, you must ensure that the limits of the generic standard EN 61000-6-3 regarding emission of radio frequency interference are observed. Suitable measures for achieving these limits for use in a mixed area, for example, include the use of filters in power supply lines.

Individual acceptance is required.

Use in residential areas

Note

HMI device not intended for use in residential area

The HMI device is not intended for use in residential areas. Operation of an HMI device in residential areas can have a negative influence on radio or TV reception.

2.5 Risk assessment of the plant

Note

Risk assessment in an F-system is always required

A risk assessment must be performed for each F-system. The responsibility lies with the operator of the plant.

The following rules apply to the risk assessment of the plant:

- EN ISO 12100:2010, Safety of machinery – General principles for design of machinery – Risk assessment and risk reduction
- ISO 13849-1, Safety of machinery - Safety-related parts of control systems - General principles for design

The results of the risk assessment leads to the Performance Levels a to e in accordance with ISO 13849-1, which indicates how the safety-related system components must be designed if the stop or emergency stop functions are needed locally in a plant segment or globally throughout the plant and which operating mode is to be used for the HMI devices in a safety-related plant area.

Also refer to the technical specifications in the section "Mobile Panel (Page 233)", section "Fail-safe operation". Take the plant configuration as a whole into consideration in the risk assessment and not just the individual areas. Additional information on risk assessment and risk reduction is available at:

"Safety Technology in SIMATIC S7" system manual
(<http://support.automation.siemens.com/WW/view/en/12490443>)

2.6 Important information on emergency stop / stop button

WARNING

Emergency stop / stop button disabled when HMI device is not connected

When the fail-safe Mobile Panel is not connected to the connection box, an emergency stop or stop cannot be triggered with the HMI device.

Install a stationary emergency stop or stop button that will be available at all times on the F-system.

WARNING

Stop functions of Category 0 or 1 according to EN 60204-1

If a category 0 or 1 stop circuit is implemented, the stop function must be effective regardless of the operating mode. A category 0 stop must take precedence. Releasing the emergency stop / stop button must not lead to any dangerous state (see also EN 60204-1, Section 9.2.5.3).

The stop function is not to be used as a replacement for safety equipment.

Hardwired F-system

The emergency stop / stop button can trigger a safe machine stop or be looped into the safety circuit of the F-system based on the configuration of the F-system. The signals of the emergency stop / stop button are wired differently in the connection boxes:

- For connection box compact and connection box standard: When the fail-safe Mobile Panel is not connected, the safety circuit is open.
- For the connection box advanced: When the fail-safe Mobile Panel is not connected, the connection of the safety circuit is bypassed and thus closed.

NOTICE

Emergency stop / stop bypass only works with fail-safe operator panel

If you use a non-fail-safe HMI device with the connection box advanced and remove it from the connection box advanced, the safety circuit is opened and the relevant plant section or the plant goes into a safe state.

Only use fail-safe Mobile Panels in conjunction with the connection box advanced in an F-system with emergency stop / stop bypass.

NOTICE
Versions of the connection box
If you install connection boxes with and without emergency stop / stop bypass in your fail-safe automation system, there is a risk that an accidental shutdown is triggered when replugging an HMI device.
In a fail-safe automation system, you should therefore only use "compact" and "standard" connection boxes together or "advanced" boxes only.

PROFIsafe-based F-system

Regardless of the type of the connection box, a fail-safe Mobile Panel must be logged off from the safety program before removing the plug of the connecting cable from the connection box. No accidental disconnection can be triggered if these instructions are followed.

2.7 Important notes for the enabling mechanism

In a numerically controlled plant, "setup mode" requires an enabling mechanism. The enabling mechanism consists of the enabling button installed on the HMI device and the corresponding logic in the HMI device.

The operating modes relevant for the enabling mechanism are:

- Setup mode
In setup mode, safety has to be ensured in a different way than in automatic mode. During setup mode, personnel enter danger zones of the plant in which controlled movements must be possible. Movements must be executed with reduced speed in setup mode in line with the risk assessment of the plant. Movement of plant parts should only be possible when the enabling mechanism is activated. Operators must have been trained accordingly and have detailed knowledge of the intended use.
- Process monitoring in manufacturing
This operation mode is used for processing complex workpieces, for example, or in cases when parts of the workpiece cannot be inspected. This operating mode allows additional manual intervention in line with DIN EN 13128 "Safety of machine tools - Milling and boring machines". Unlike in automatic mode, the user is able to monitor and control the processing process with open separating protective devices.

Safety instructions

 WARNING
<p>Injury or material damage</p> <p>Enabling buttons should only be used when the following applies for the person activating the enabling button:</p> <ul style="list-style-type: none"> • The person can see the danger zone. • The person is capable of recognizing personal injury hazards in good time. • The person is capable of taking immediate measures to avoid danger. <p>The only person allowed to remain in the danger zone is the person who is activating the enabling button.</p>

 WARNING
<p>Injury or material damage</p> <p>If you trigger a command for a hazardous operating state with the enabling button only, there is a risk of injury or material damage.</p> <p>A hazardous operating state requires a second, specific operation with another key on the HMI device. Consider this during configuration.</p>

NOTICE
<p>Enabling button must not be fixed</p> <p>Fixing the enabling button in one of its positions can cause malfunctions in the fail-safe automation system.</p> <p>Make sure that the enabling button is not being held permanently in any of its positions.</p>

Note

The enabling button is effective when the HMI device is connected to a connection box. The following applies:

- "E-stop button evaluated by PROFIsafe" operating mode
The PROFIsafe-based F-system is configured so that the "Enabling" function is active, see section Configuring F-FBs in STEP 7 (Page 174)". The HMI device is logged onto PROFIsafe and the emergency stop / stop button is lit.
- "E-stop button evaluated by safety relay" operating mode
The emergency stop button is lit.
- "Stop button evaluated by safety relay" operating mode
The emergency stop / stop button is not lit with this operating mode..

Note

Information on discrepancy errors

The enabling button has two channels. Both channels must be activated at the same time for the "enable" and "panic" switch positions. If only one channel is activated, a discrepancy error occurs and "enabling" is no longer possible. To reactivate "enabling", press the enabling button once completely into the "panic" position and then release it.

Installing system components

3.1 Checking the delivery

Check the scope of delivery for visible signs of shipping damage and make sure that it is complete, see section "Scope of delivery (Page 20)".

Note

Do not install parts damaged during shipment. In the case of damaged parts, contact your Siemens representative. See section "Service and support (Page 268)".

3.2 Mounting the connection box compact

3.2.1 Mounting position, mounting cutout and clearance

Mounting position

The connection box is designed for installation in the following types of fixed enclosure:

- Mounting cabinets
- Control cabinets
- Control panels
- Consoles

The connection box compact can be installed in any mounting position.

Mounting cutout

The degree of protection is guaranteed if the following conditions are met:

Material thickness at the mounting cutout	2 to 6 mm
Deviation from plane at the mounting cutout	≤ 0.5 mm This condition also applies for the installed connection box.
Surface roughness in the area of the mounting seal	≤ 120 μm (R _z 120)

3.2 Mounting the connection box compact

The following illustration shows the dimensions for the mounting cut-out, all dimensions in mm:

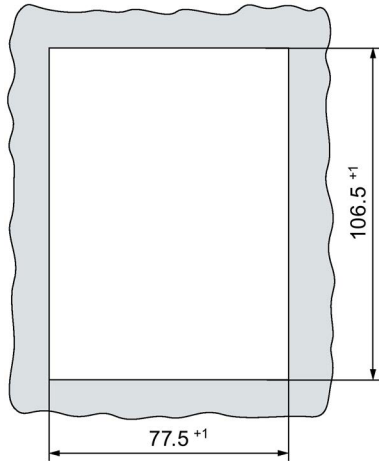

Clearance

The connection box is self-ventilated. To ensure self ventilation in the control cabinet and be able to connect the connecting cable without any problems, you need the clearance indicated in the figures below, all dimensions in mm:

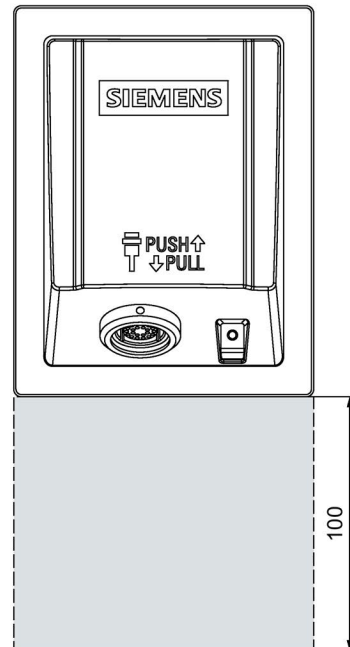
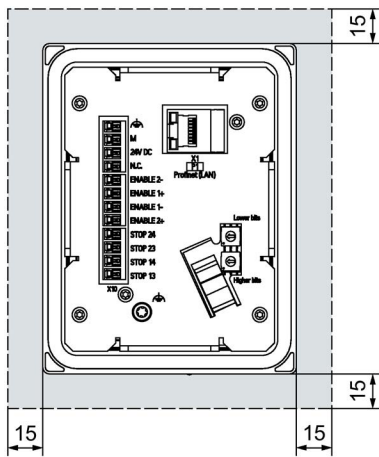

Note that in addition to the mounting depth of the connection box, a rear clearance is required based on the leads and plugs used.

Note

Ensure that the maximum ambient temperature as detailed in "Operating Conditions (Page 224)" is not exceeded when installing the device in closed enclosure.

Allow for 100 mm of clearance below the connection box to enable you to easily plug in the connecting cable.

3.2.2 Fastening the connection box compact

Read the instructions for work in and on electrical systems and on ESD in "General safety instructions (Page 31)".

Requirement

- 4 mounting clips
- 1 torque screwdriver with slot insert size 2

Procedure

1. Check for damage to the mounting seal on the connection box.
Do not install a connection box with a damaged mounting seal.
2. Insert the connection box in the mounting cutout.
Secure the connection box to prevent it from falling out.
3. Place one mounting clip into each of the four cutouts marked.

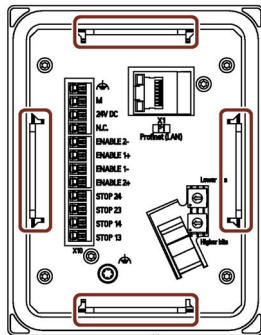

4. Fasten the mounting clips.

The permitted torque is 0.2 Nm.

You can find information on the electrical connection of the connection box in the section "Connecting the connection box (Page 59)".

3.3 Installing the connection box standard and connection box advanced

3.3.1 Mounting position and clearance

Mounting position

The connection box is designed to be mounted on a vertical surface of a stationary enclosure.

The connection box standard and connection box advanced can be installed in any mounting position.

Clearance

To ensure unhindered access to the interfaces, the clearance indicated in the figure below is required:

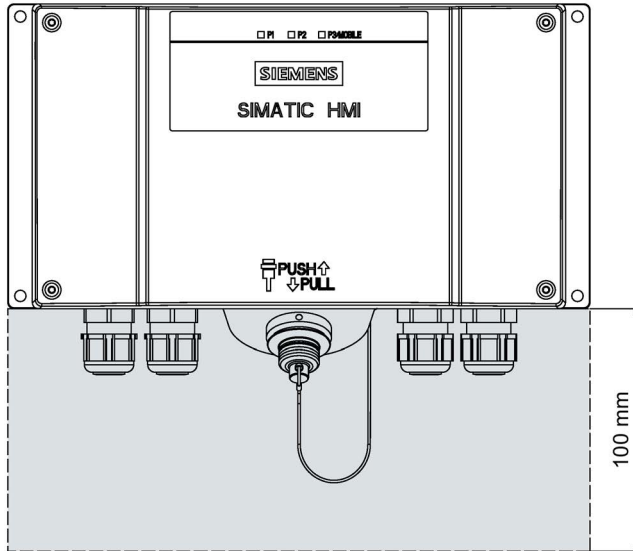

3.3.2 Fastening the connection box standard and connection box advanced

This section describes the mounting of the Anschluss box standard and the connection box advanced on a flat metal surface, such as a control cabinet wall.

Requirement

- 4 M5 cylinder head screws
- 1 suitable screwdriver

Procedure

In this example, the fastening described is outside of a control cabinet wall.

1. Hold the connection box on the area where you want to mount it.
2. Mark locations for the mounting holes.
3. Drill holes or threaded holes for the 4 cylinder head screws according to your requirements.
4. Attach the connection box.

See also

Dimension drawing for connection box standard and connection box advanced (Page 231)

3.4 Attaching the KTP Mobile wall-mounting bracket

3.4.1 Assembling the KTP Mobile wall-mounting bracket

The scope of supply for the wall-mounting bracket includes the following components:

- Wall-mounting bracket
- Safety bar for the HMI device
- 2 screws for fastening the safety bar
- Holding bracket for the connecting cable

The wall-mounting bracket is suitable for all HMI devices of the KTP Mobile type.

Requirement

- 1 torque screwdriver with T10 insert

Procedure

1. Position the safety bar as shown in the figure. Note the type of your HMI device in doing so. The figure, for example, shows the position of the safety bar for a KTP900/KTP900F Mobile.
2. Fasten the safety bar screws with the T10 screwdriver in the required places. The permitted torque is 0.8 Nm.
3. Slide the holding bracket for the connecting cable from one side into the mounting flange.
4. Slide the holding bracket for the connecting cable from the other side into the mounting flange until the holding bracket is aligned with the center of the wall-mounting bracket.

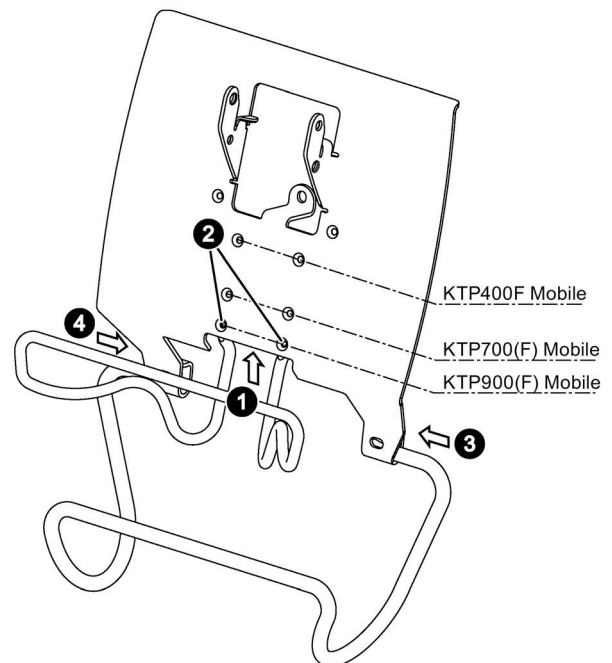

If you fasten the wall-mounting bracket to the mounting surface as described in the following section, the holding bracket is secured against lateral movement.

3.4.2 Mounting position and clearance

Mounting position

The KTP Mobile wall-mounting bracket is designed for vertical walls or one of the following types of enclosures:

- Mounting cabinets
- Control cabinets
- Control panels
- Consoles

The wall-mounting bracket can be installed vertically or tilted slightly backwards.

 CAUTION
The wall-mounting bracket must be mounted securely If the wall-mounting bracket is not mounted securely, it can fall off together with the HMI device and the connecting cable. This can result in personal injury or material damage. Select a mounting location with sufficient load-carrying capacity for the total weight of the wall-mounting bracket, HMI device and connecting cable. Choose the corresponding fixing material. Weight information is available in section "Technical specifications (Page 233)".

NOTICE
Do not attach the wall-mounting bracket to a moving or vibrating enclosure When attaching the wall-mounting bracket to a moving or vibrating enclosure, the Mobile Panel can fall out of the wall-mounting bracket. Only attach the wall-mounting bracket on a motionless and vibration-free enclosure.

Note

A position at eye level facilitates operation of the Mobile Panel when it is mounted in the wall-mounting bracket.

If you want to operate the HMI device in a stationary position, note the length of the connecting cable to the connection box when selecting the location for the KTP Mobile wall-mounting bracket.

Clearance

Consider the space required for the connecting cable used and the height that the HMI device extends up and over the wall-mounting bracket.

The figure below shows the minimum clearance required around the wall bracket.

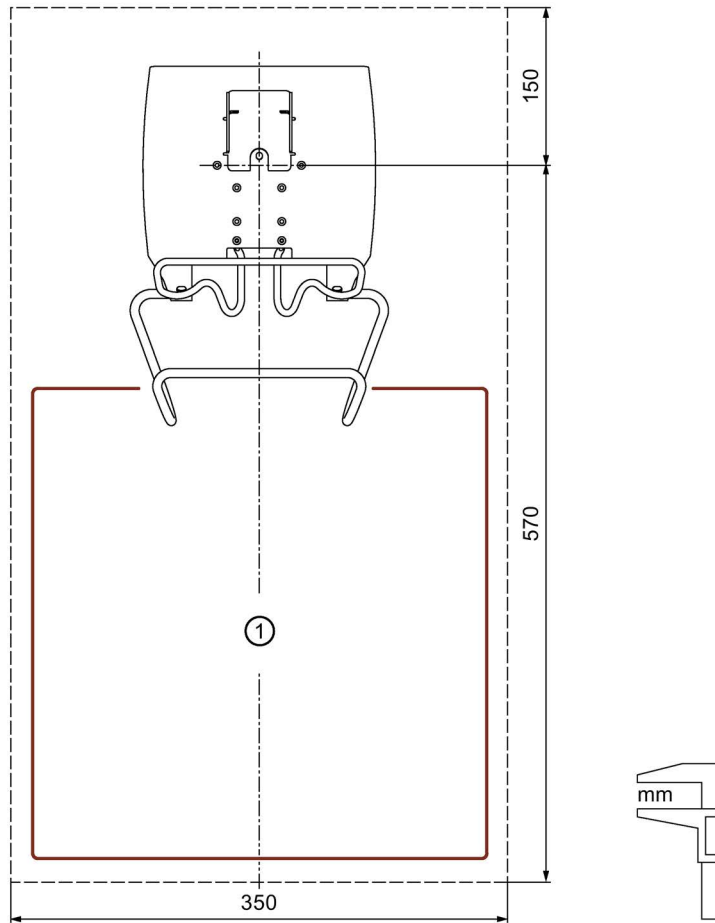

① Space requirements for connecting cable

3.4.3 Fasteneing the KTP Mobile wall-mounting bracket

Requirement

The requirements refer to the installation of the wall-mounting bracket to a control cabinet.

- A level bolting surface
- 3 M5 bolts and a suitable screwdriver
- 3 M5 nuts and a suitable wrench

Procedure

1. Place the wall-mounting bracket level on the mounting surface.
2. Mark the drill holes at the indicated locations in the figure on the right.
3. Drill 3 holes for M5 type bolts based on your mounting requirements.
4. Fasten the wall-mounting bracket with the bolts and nuts.

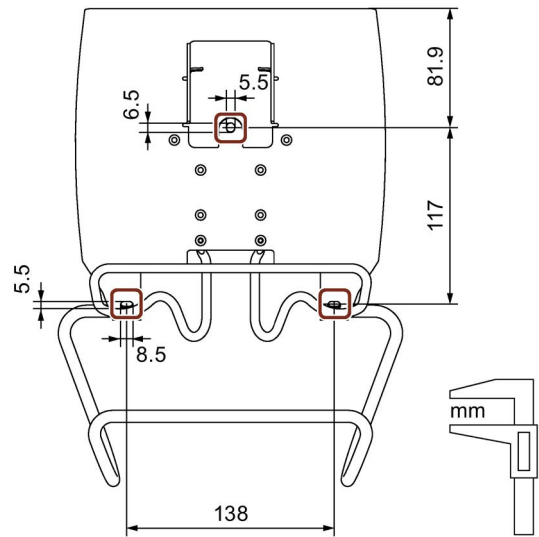

See also

KTP Mobile wall-mounting bracket dimension drawing (Page 232)

3.5 Connecting the Mobile Panel

3.5.1 Connection information

The Mobile Panel is supplied with an open terminal compartment. During commissioning, you will be working with an open terminal compartment when replacing the SD card or when replacing the connecting cable. To avoid damage to the HMI device, read the information in the section "General safety instructions (Page 31)" about working in and on electrical systems and about ESD.

NOTICE

Foreign objects and liquids

Foreign objects or liquids can cause a short-circuit inside the HMI device and damage the HMI device accordingly.

Pay attention to cleanliness. Keep foreign objects and liquids away while working on the terminal compartment of the HMI device.

Connection sequence

Keep to the following connection sequence:

- SD memory card, if required
- KTP Mobile connecting cable
- Connection box
- Configuration PC, if required

3.5.2 Inserting the SD memory card

All Mobile Panels 2nd Generation, with the exception of the KTP400F Mobile, have a slot for an optional SD memory card. If you do not want to install an SD memory card, you can skip this section during commissioning.

Note

SD card either for automatic backup or for data storage

For HMI devices with a slot for an SD memory card: You can use the SD memory card either for automatic backup or for data storage, e.g. for archiving.

The "automatic backup" and "archiving" functions cannot be used at the same time on the SD memory card.

Note

Use only a SIMATIC HMI Memory Card

Use only a SIMATIC HMI Memory Card with the Mobile Panel.

NOTICE

Unsuitable tools may damage the Mobile Panel

To avoid damaging the motherboard of the Mobile Panel, insert or remove the SD memory card with an appropriate tool made of plastic.

Requirement

- The Mobile Panel is deenergized.
- The terminal compartment is open.
- The connection cable is not attached.
- You have taken precautions to protect your device, see section "Connection information (Page 51)".
- A suitable tool made of plastic

Procedure

1. Turn the storage medium so that the contacts are pointing towards the motherboard.
2. Push the storage medium into the slot with the suitable tool.



See also

Replacing the Mobile Panel (Page 215)

3.5.3 Connecting the Mobile Panel connecting cable

The connecting cable is a system component and is required for the operation of the Mobile Panel.

Use a cable labeled "Connecting cable KTP Mobile".

Note

If you use an SD memory card, you must insert the SD memory card before installing the connecting cable. See section "Inserting the SD memory card (Page 51)".

Requirement

- You have taken precautions to protect your device, see section "Connection information (Page 51)".
- One torque screwdriver with cross-tip insert size 2

Procedure

1. Plug the connector into port X80.
Note the mechanical coding on the connector.

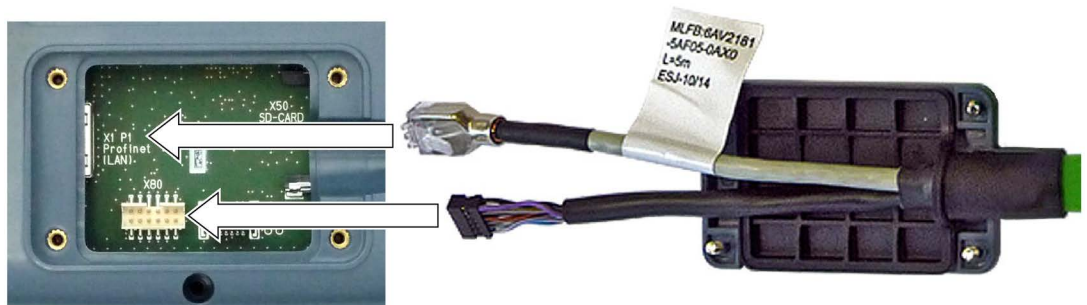

2. Plug in the RJ45 connector at port X1.
Make sure that the connector audibly engages.
3. Place the terminal compartment cover over the terminal compartment. Tighten the corresponding screws using a torque of 0.2 Nm.

Note

- When closing the terminal compartment cover, make sure that the corresponding seal is undamaged and properly seated. Otherwise the specified degrees of protection cannot be guaranteed.
 - Make sure that the cables in the terminal compartment are not bent too much.
 - When closing the terminal compartment cover, be careful not to trap the cables.
-

4. All Mobile Panels 2nd Generation with the exception of the KTP400F Mobile: Attach the retainer.

3.5.4 Connecting a Configuring PC

You can transfer the following data between the HMI device and a configuration PC:

- Project
- HMI device image
- Additional project data

Procedure

1. Connect the configuration PC to an Ethernet network.
2. Connect the Mobile Panel to a connection box which is connected to the configuration PC via the Ethernet network.

The figure below shows an example of how to connect a KTP900F Mobile to a connection box compact.

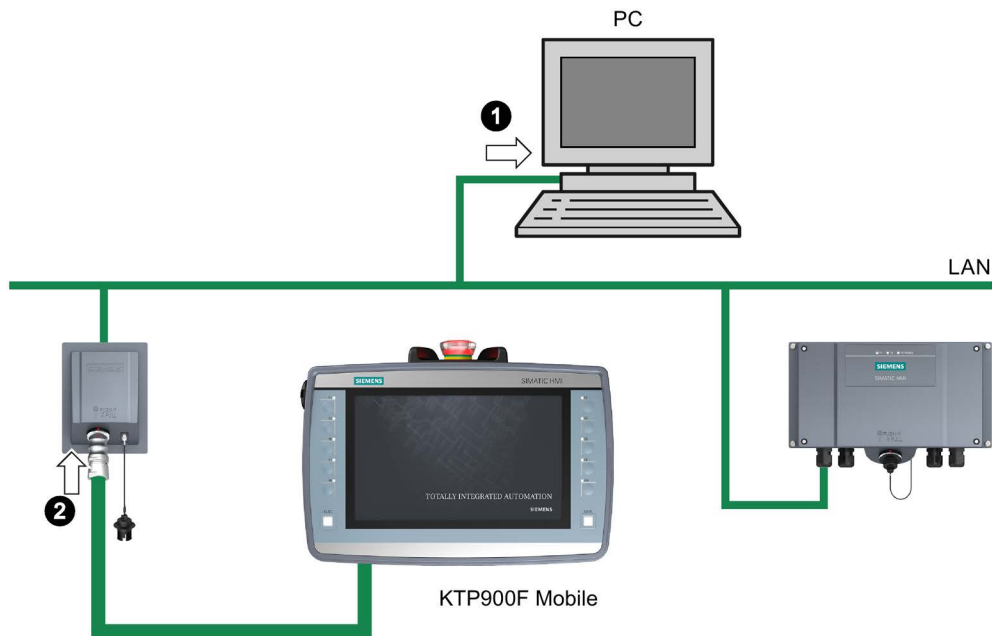

Section "Transferring a project with WinCC (Page 191)" describes how to transfer a project from the configuration PC to the Mobile Panel.

3.5.5 Replacing the connecting cable

Requirement

- The connecting cable is unplugged from the connection box.
- You have taken precautions to protect your device, see section "Connection information (Page 51)".
- One torque screwdriver with cross-tip insert size 2

Procedure

Open

1. Place the HMI device on its front.

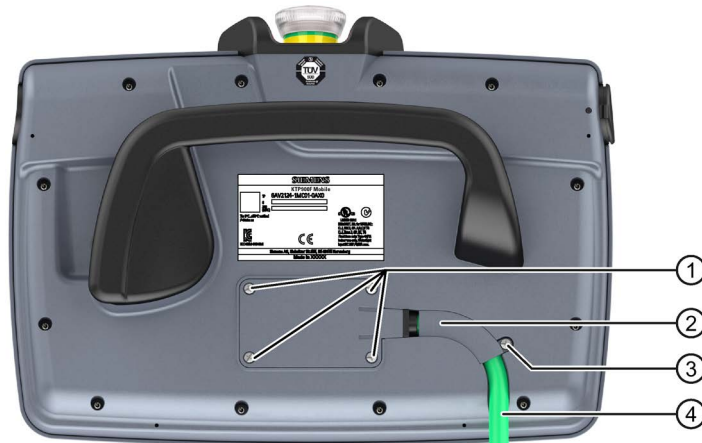

- ① Screws for terminal compartment cover
- ② Retainer, not for KTP400F Mobile
- ③ Screw for the retainer, not with KTP400F Mobile
- ④ Connecting cable

2. All Mobile Panels 2nd Generation with the exception of the KTP400F Mobile: Loosen the screw ③.
3. Loosen the screws ① of the terminal compartment cover.
4. Lift the terminal compartment cover to expose the connecting cable.

Replacing the connecting cable and closing the terminal compartment

1. Remove the RJ45 plug from the X1 port.
2. Remove the connector from the X80 port.
3. Remove the connecting cable.
4. Position the replacement cable so that the terminal compartment cover fits exactly over the terminal compartment.
5. Position the end of the connecting cable in the guide.
6. Plug the connector into port X80. Note the mechanical coding on the connector.
7. Plug in the RJ45 connector at port X1. Make sure that the connector audibly engages.
8. Place the terminal compartment cover over the terminal compartment. Tighten the corresponding screws using a torque of 0.2 Nm.

Note

- When closing the terminal compartment cover, make sure that the corresponding seal is undamaged and properly seated. Otherwise the specified degrees of protection cannot be guaranteed.
 - Make sure that the cables in the terminal compartment are not bent too much.
 - When closing the terminal compartment cover, be careful not to trap the cables.
-

9. All Mobile Panels 2nd Generation with the exception of the KTP400F Mobile: Attach the retainer.

See also

Connecting the Mobile Panel connecting cable (Page 53)

3.5.6 Replacing an SD memory card

All Mobile Panels 2nd Generation, with the exception of the KTP400F Mobile, have a slot for an optional SD memory card.

Note**Use only a SIMATIC HMI Memory Card**

Use only a SIMATIC HMI Memory Card with the Mobile Panel.

NOTICE**Unsuitable tools may damage the Mobile Panel**

To avoid damaging the motherboard of the Mobile Panel, insert or remove the SD memory card with an appropriate tool made of plastic.

Requirement

- The Mobile Panel is deenergized.
- The terminal compartment is open.
- The connecting cable is removed.
- You have taken precautions to protect your device, see section "Connection information (Page 51)".
- A suitable tool made of plastic for gripping the SD memory card
- One torque screwdriver with cross-tip insert size 2

Procedure

Removing the SD memory card

1. Grab the SD memory card with an appropriate tool.
2. Pull the SD memory card from the slot to the center of the terminal compartment.

Inserting a new SD memory card

1. Turn the SD memory card so that the contacts are pointing towards the motherboard.
2. Push the SD memory card into the slot with the appropriate tool.
3. Attach the connecting cable to the Mobile Panel.
4. Close the terminal compartment cover. Tighten the corresponding screws using a torque of 0.2 Nm.
5. Fasten the retainer.
6. Connect the Mobile Panel to a connection box.

When the "Use system card?" dialog appears on the display, confirm the message.

3.5.7 Inserting the USB memory stick

The USB port is used to transfer data and save specific HMI device data.

NOTICE
USB port only enabled for USB flash drive The USB port is only enabled for use with an industrial-grade USB flash drive for commissioning and maintenance purposes.
Degrees of protection not guaranteed with USB flash drive When a USB flash drive is connected to the USB port, the degrees of protection specified for the Mobile Panel are not guaranteed. Do not connect a USB device if dust or moisture is present at the location of use that can enter the HMI device.

Requirement

- An industrial-grade USB flash drive

Procedure

1. Remove the cover from the USB port.
2. Insert the USB flash drive into the slot.

See also

Storage media (Page 22)

Functions for service and commissioning (Page 144)

3.6 Connecting the connection box

3.6.1 Connection information

 CAUTION
Properties of cables to be used Note the Specification of cables to be used (Page 242) before you start connecting. Use only cables that meet the specification. Use shielded standard cables for all remaining data cables. You can find information on standard cables and additional information at: Industry Mall (https://mall.industry.siemens.com)

NOTICE
Foreign objects or liquids Foreign objects or liquids can cause a short-circuit inside the connection box and damage the connection box or HMI device accordingly. Pay attention to cleanliness. Keep foreign objects and liquids away while working on the connection box. Take care when working on the connection box that conducting materials, such as bare cable leads, do not come into contact with the electrical circuits.

NOTICE
Observe local installation regulations Observe the local installation regulations and the local installation conditions, such as protective wiring for power supply cables, when connecting the cables. Short-circuit and overload protection Different measures for short-circuit and overload protection are required when setting up an entire plant. The type of components and the level of obligation for the protective measures depends on the regulation that applies to your plant configuration.

Connection sequence

NOTICE
Potential damage to property with incorrect connection sequence Failure to adhere to the connection sequence can damage the connection box.

Connect the connection box in the following sequence:

1. Functional grounding
2. Power supply
3. Control via PROFINET (LAN)
4. Other Ethernet devices, such as an additional connection box

3.6.2 Opening and closing connection box standard and connection box advanced

The connection boxes standard and advanced must be opened for connecting and setting the box ID. To avoid damage to the connection box, read the information in the section "General safety instructions (Page 31)" about working in and on electrical systems and about ESD.

Requirement

- The connection box is de-energized.
- Torque screwdriver with T10 insert

Procedure

Open

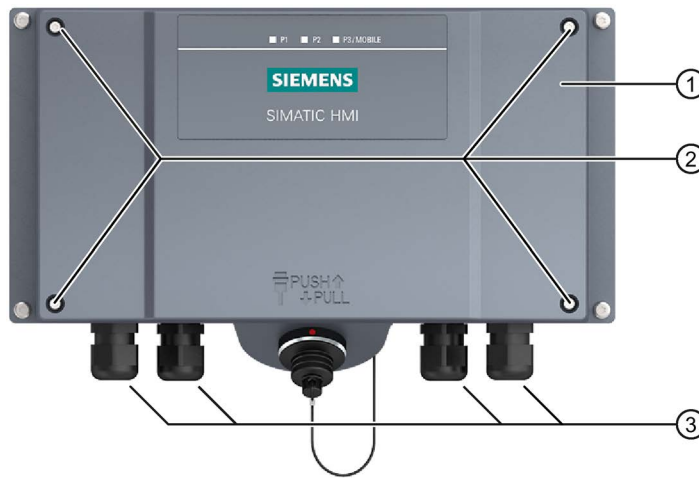

- ① Cover
- ② Screws
- ③ Screw glands M16x1.5 for cable diameters 5 to 10 mm

1. Loosen the 4 screws ②.
2. Lift the cover ① carefully, because the seal may stick to the lid and can be pulled out.
3. Remove the screws and the cover.

The following protective cover is visible:

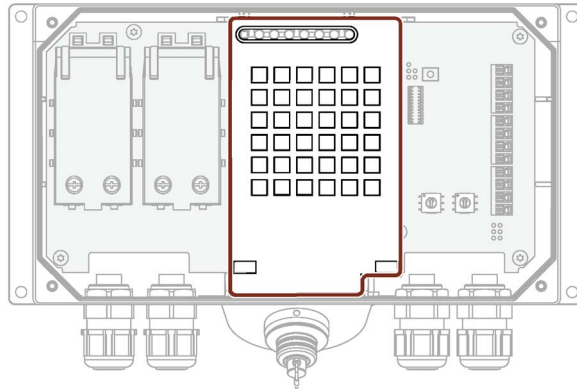

NOTICE

Damage to the connection box

Without a protective cover, there is a risk that the electronics of the connection box are damaged or destroyed.

Do not remove the protective cover.

Close

Follow the steps for opening in reverse order.

NOTICE

Permissible torque

The connection box enclosure is made of plastic. Therefore, the mounting hole threads cannot handle the same amount of stress as a comparable metallic enclosure. If the screws are tightened with too great a torque or more than 20 times, there is risk of damage to the thread.

Do not exceed 0.4 to 0.5 Nm of torque when tightening the screws.

Note

During assembly, make sure that the seal for the cover is inserted and not damaged. Otherwise the specified degrees of protection cannot be guaranteed.

3.6.3 Equipotential bonding of connection boxes

Potential differences

Differences in potential between separated plant components can lead to high equalizing currents over the data cables, destroying the circuits. This situation may arise if the cable shielding is terminated at both ends and grounded at different system parts.

Differences in potential can also be caused by different mains supplies.

General requirements for equipotential bonding

Differences in potential must be reduced far enough with equipotential bonding conductors to ensure error-free operation of the relevant electronic components. The following information must therefore be observed when installing the equipotential bonding:

- The effectiveness of equipotential bonding increases as the impedance of the equipotential bonding conductor decreases or as its cross-section increases.
- If two plant sections are interconnected by means of shielded data cables and their shielding is connected at both ends to the grounding/protective conductor, the impedance of the additionally installed equipotential bonding conductor must not exceed 10% of the shielding impedance.
- The cross-section of a selected equipotential bonding conductor must be capable of handling the maximum equalizing current.
Equipotential bonding cables are required between two control cabinets with a minimum conductor cross-section of 16 mm².
- Use equipotential bonding conductors made of copper or galvanized steel. Connect the equipotential bonding conductors to the ground / protective conductor over a wide area. Protect the equipotential bonding conductors against corrosion.
- Clamp the shielding of the data cable on the HMI device flush and near the equipotential busbar using suitable cable clamps.
- Route the equipotential bonding conductor and data cables in parallel with minimum clearance between them.

Note

Cable shielding is not suitable for equipotential bonding. Always use the prescribed equipotential bonding conductors. When installing PROFINET networks, always use cables with a sufficient cross-section. Otherwise, there is a risk that interface components will be damaged or destroyed.

3.6.4 Connecting the functional grounding and power supply to the connection box

The power supply for the HMI device is connected to a terminal strip in the connection box. The connection box has reverse polarity protection.

 WARNING
24 V DC power supply
If the supply voltage is outside the specified range, it may cause the HMI device to malfunction. This can result in personal injury or material damage.
Use a 24 V DC power supply with the following properties for the connection box:
<ul style="list-style-type: none">• Safe electrical isolation according to IEC 60364-4-41 or HD 384.04.41 (VDE 0100, Part 410).• The power supply provides safety extra-low voltage according to SELV/PELV up to a maximum of 36 V DC and also does not exceed $U_m = 36$ V DC in case of fault. Refer to the information in the data sheet for overvoltage protection in the event of an internal error or take appropriate voltage-limiting measures, such as the use of a surge protection device.

NOTICE
External protective circuit
An external protective circuit is required for operation with 24 V DC; please refer to section 7 "Lightning protection and overvoltage protection" in the following function manual: "Designing interference-free SIMATIC S7-1500, ET 200MP, ET 200SP, ET 200AL controllers (https://support.industry.siemens.com/cs/ww/en/view/59193566)".

Requirement

- The power supply meets the requirements set out in "Technical specifications (Page 233)".
- The connection box standard or advanced is open.
- Read the information on power supply cables and equipotential bonding cable in the section "Specification of cables to be used (Page 242)".
- The wires of the power supply cable have been stripped by 8 mm.
- Matching ferrules when using flexible cables

Procedure

1. For connection box standard and connection box advanced: Thread the cables through the corresponding screw glands.
2. When you use flexible cables, place a wire end ferrule on each wire to be connected.
3. Insert the wire ends into the associated spring-loaded terminal as shown in the figures below.

The figure below shows the contacts to be connected to the X10 terminal of the connection box and the cable glands for cable entry.

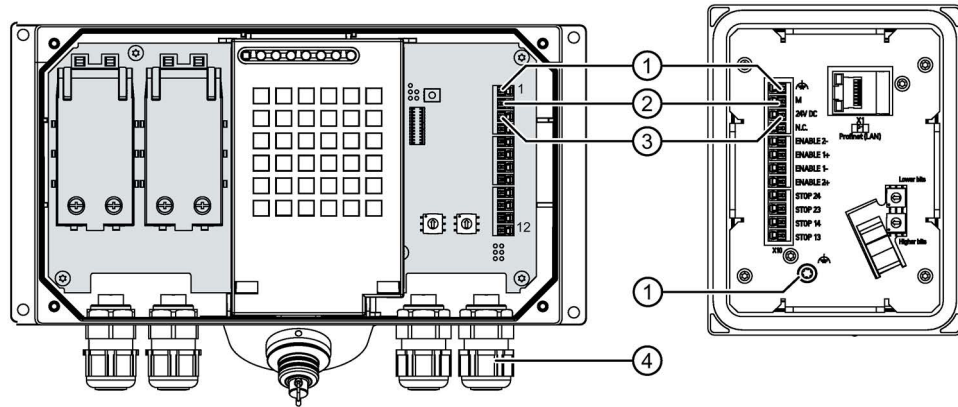

- ① Connection for functional ground
- ② M24
- ③ P24
- ④ Screw gland

4. Connect the equipotential bonding conductor to the equipotential busbar.
5. Connect the equipotential bonding conductor to the terminal for the functional ground of the connection box.

Connect the equipotential bonding conductor of the connection box as described in the section "Equipotential bonding of connection boxes (Page 62)".

Note

Applies to floating system design:

Connect the terminal for GND 24 V from the 24 V power supply output to equipotential bonding for uniform reference potential.

6. For connection box standard and connection box advanced:
When all the required work has been completed in the connection box, close it.

3.6.5 Connecting cables for a hardwired F-system

The signals for the emergency stop / stop button and the enabling button must be wired for a hardwired F-system.

NOTICE
Length of the data cables to the connection box
If the permissible length of the data cables and signal cables between a connection box and the plant is exceeded, malfunctions may occur. Keep the permissible length of ≤ 30 m for cables between the connection box and the evaluation unit.

Note

If a connection box is to be operated in "E-stop button evaluated by PROFIsafe" mode, the connection box cannot be wired according to a hardwired F-system.

Requirement

- The connection box standard or advanced is open.
- Read the information on the number of connecting cables required in the section "Specification of cables to be used (Page 242)".
- The wires of the connection cables have been stripped by 8 mm.
- Matching ferrules when using flexible cables

Procedure

1. Connection boxes standard and advanced:
Thread the cables through the corresponding screw glands.
2. When you use flexible cables, place a wire end ferrule on each wire to be connected.

3. Insert the wire ends into the associated spring-loaded terminal as shown in the figures below.
The figure below shows the terminals to be connected to the connection box.

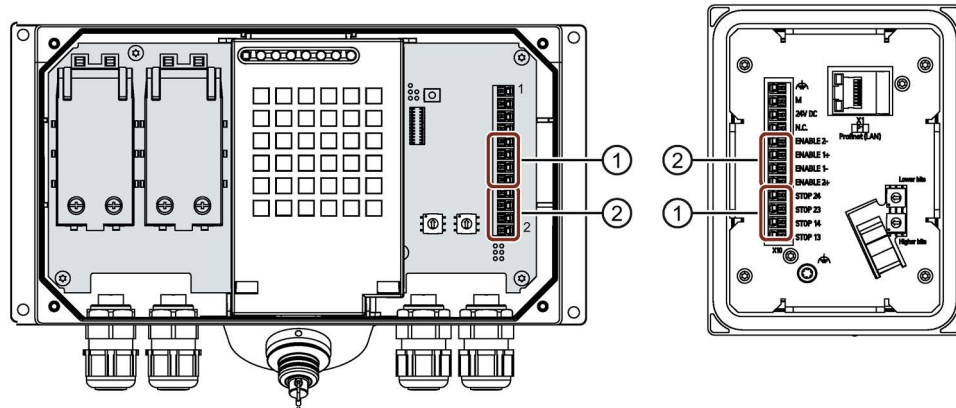

- ① Terminal for the emergency stop / stop button
- ② Terminal for the enabling button

4. Connect the cables. Depending on the connection box, observe the pin assignment of interface X10:
 - Connection box standard and connection box advanced (Page 249)
 - Connection box compact (Page 245)
5. For connection box standard and connection box advanced:
When all the required work has been completed in the connection box, close it.

3.6.6 Connecting Ethernet to the connection box

You can connect a controller or other Ethernet devices to the connection box. Compatible controllers are listed in the section "Communication with controllers (Page 253)".

Note

- Only use a switch or comparable device to connect the connection box to public Ethernet networks.
 - Follow the information in the "SIMATIC PROFINET system description (<https://support.industry.siemens.com/cs/us/en/view/19292127>)" manual for setting up a PROFINET network.
-

Note

Using an Ethernet data transmission rate of 100 Mbps

The Ethernet data transmission rate of 10 Mbps is not supported by 2nd generation Mobile Panels.

Use a data transmission rate of 100 Mbps for communication with the Mobile Panel.

Maximum cable lengths

Ethernet cable	Connection box used	Maximum cable length including connecting cable
Between Mobile Panel and connection box	<ul style="list-style-type: none">• Connection box compact• Connection box standard• Connection box advanced	25 m
Between Mobile Panel and PROFINET/PROFIsafe station	<ul style="list-style-type: none">• Connection box compact	100 m
	<ul style="list-style-type: none">• Connection box standard• Connection box advanced	125 m

Requirement

- The connection box is mounted.
- Connection box compact:
 - 1 preassembled Ethernet cable including Ethernet connector.
Recommendation: Use an angled connector, for example, an RJ45 connector with article number 6GK1901-1BB20-2Ax0.
x stands for the variant key of the article number.
- Connection boxes standard and advanced:
 - The connection box is open.
 - 1 Ethernet cable (not preassembled)
 - 1 screwdriver, PZ 2
 - 1 stripping toolSee the online catalog at "Industry Mall (<https://mall.industry.siemens.com>)".

Procedure

Connection box compact

1. Connect the RJ45 connector of the Ethernet cable with the RJ45 socket marked in the figure below.

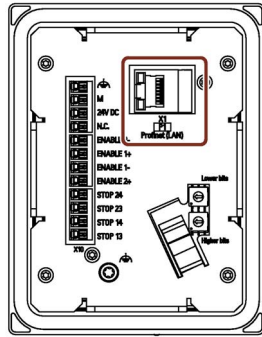

Note

LEDs on the RJ45 socket not active

The two LEDs at the RJ45 socket of the connection box compact are not supported by the hardware and do not light up during operation.

Connection boxes standard and advanced

1. Strip the insulation on the Ethernet cable as shown in the figure below.



2. Open fast connector 1.

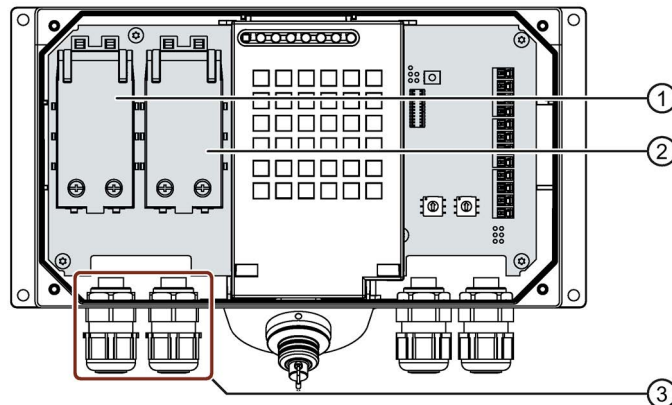

- ① Fast connector 1
- ② Fast connector 2
- ③ Screw gland

3.6 Connecting the connection box

3. Push the Ethernet cable through the screw gland and connect the wires as detailed in the interface description in "Fast connector X1 and X2 (Page 249)".
4. Close the fast connector.
Closing the fast connector establishes the contact to the wires in the Ethernet cable.
5. Tighten the screw cap on the screw gland.
The specified degrees of protection are only met when the screw cap has been tightened.
6. Once all the required work in the connection box has been completed, close it.

See also

Connection information (Page 59)

3.6.7 Setting the box ID of the connection box

You need to set a box ID for each connection box. If configured, the box ID can be read by the HMI device and transmitted to the PLC.

The box ID allows connection point detection. The procedure is described in the section "Configuring connection point detection (Page 179)".

Note

You need to set a box ID for each connection box. Do not assign the same box ID twice.

Note

Changing the box ID of a connection box

Observe the following information when changing the box ID of a connection box:

- If you want to change the box ID of a connection box, remove the connection box from its power supply before you set the box ID with the rotary coding switch.
 - After you have confirmed the changed box ID in the dialog "Safety operation", unplug the HMI-device connecting cable from the connection box and then plug it into the connection box again.
-

Rotary encoder switch

- Position of the rotary coding switch in the connection box compact

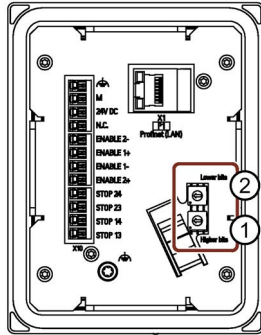

- Position of the rotary coding switch in the connection boxes standard and advanced

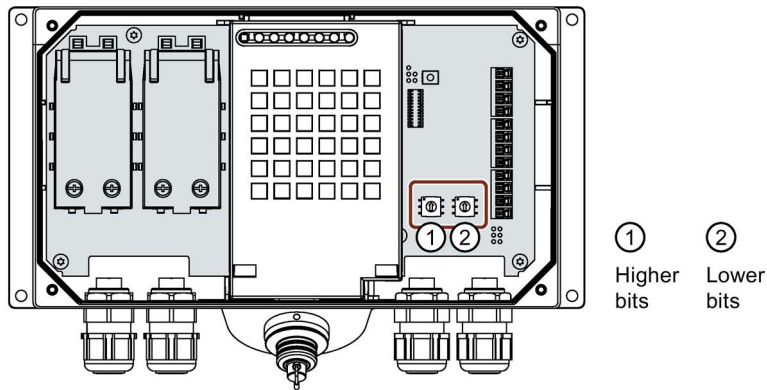

Requirement

- For connection box standard and connection box advanced: The connection box is open.
- The connection box is disconnected from its power supply.
- A suitable tool made of plastic

Procedure

1. Rotate the arrows of the rotary coding switch to the required hexadecimal value using a suitable tool.

Values from "00" to "FF" (0 to 255 in decimal form) can be set with the rotary coding switches.

When setting the box ID:

- Use the value "00" only for the "Stop button evaluated by safety relay" operating mode.
- The value "FF" (255) is reserved and may not be used.

Example:

The figure below shows an example of the rotary coding switch for a connection box standard. "27H" (39 in decimal form) is set for the box ID as an example.

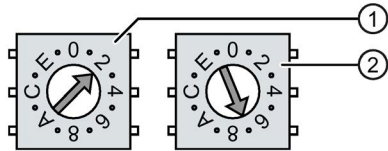

- ① Rotary encoding switch for more significant bits
This is the lower rotary coding switch in the connection box compact and the left rotary coding switch in the connection boxes standard and advanced.
 - ② Rotary encoding switch for less significant bits
2. For connection box standard and connection box advanced:
When all the required work has been completed in the connection box, close it.

See also

Assigning a safety-related operating mode (Page 142)

3.6.8 Secure cables and seal screw glands

Once all cables are connected to the connection box, the following final steps should be carried out:

- Connection box compact: Strain relief for cables on the back of the connection box
- Connection box standard and connection box advanced: Seal and secure screw glands

Requirement

For the connection box compact:

- 1 cable tie
- 1 diagonal cutter

For connection box standard and connection box advanced:

- The connection box is closed.

Procedure

Connection box compact

- Secure all connected cables with a cable tie on the fastening element, which is labeled in the figure on the right.

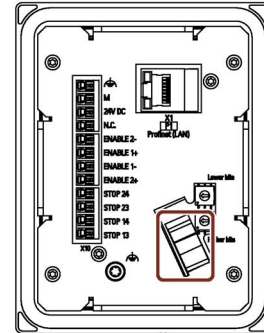

Connection box standard and connection box advanced

1. Check whether the cover is located in the cable glands that are not in use.
2. If a cover is missing, replace it.
3. Tighten the screw cap.



This will ensure IP65 degree of protection for the connection box standard or the connection box advanced.

3.7 Connecting the KTP Mobile connecting cable to the connection box

The connecting cable can be connected to the connection box using the connector. The connector is coded to prevent faulty insertion. The connecting cable is described in the section "KTP Mobile connecting cable (Page 17)".



- ① Positioning mark
- ② Outer sleeve

Procedure

Connecting

NOTICE

The status of keyswitch and illuminated pushbuttons is evaluated immediately after connection.

When you connect an HMI device to the connection box and evaluate operator controls over PROFINET IO as direct buttons:

The status of the keyswitch, the illuminated pushbuttons and the corresponding LEDs is evaluated immediately. This can cause unintentional responses.

Check the position of the keyswitch and do not activate the illuminated pushbutton before or during connection.

1. Align the positioning mark of the connector with the positioning mark on the socket of the connection box.
2. Connect the plug to the connection socket of the connection box.

Additional characteristics of the Mobile Panel are described in the section "Testing Mobile Panel readiness for operation (Page 85)".

Unplugging

NOTICE

PROFIsafe-based F-system: Logoff required

In a PROFIsafe-based F-system, logoff from the safety program is required before unplugging the connecting cable.

If you unplug the connecting cable without logoff, the plant will switch to a safe operating state.

NOTICE

Hardwired F-system: No automatic emergency stop / stop bypass for connection box compact and connection box standard

When unplugging the connecting cable from the connection box compact or a connection box standard, there is no automatic bypass of the emergency stop / stop circuit. Without further actions, an emergency stop or stop is triggered in the plant and the plant switches to a safe state.

Take appropriate circuitry measures to prevent an undesired emergency stop or stop of the plant.

For fail-safe HMI devices, see the section "Fail-safe operation > Unplug connecting cable (Page 211)".

To unplug the cable, follow these steps:

1. Pull the outer bushing of the connector. Make sure that you do not tilt the connector when you unplug it.
2. If you do not intend to use the HMI device with a different connection box, place the HMI device in its wall-mounting bracket.

Note

- Wait for about 1 second after you have unplugged the connecting cable from the connection box before you plug in the connecting cable again.
 - The specified degrees of protection are met at the connection socket of the connection box when the connecting cable or the cover of the connection socket is inserted.
-

3.8 Selecting the connection box

The connection box is generally removed in the reverse order used for installing and connecting.

Requirements

- No Mobile Panel is connected to the connection box.
- The cover of the connection socket for the connecting cable is located on the connection box.

Procedure

Connection box compact

1. Switch off power supply to the connection box.
2. Remove all cable ties on the connection box used for strain relief of the connecting cables on the associated fixing element.
3. Disconnect the following cables from the connection box:
 - Equipotential bonding cable at the equipotential bonding screw
 - All cables at the port X10
 - The Ethernet cable at the port X1
4. Loosen the screws of the mounting clips and remove all mounting clips.
5. Remove the connection box from the mounting cutout.

Connection box standard and connection box advanced

1. Switch off power supply to the connection box.
2. Open the connection box.
3. Disconnect the following cables from the connection box:
 - All cables at the port X10
 - The Ethernet cables at Fast Connector X1 and Fast Connector X2
4. Thread all connecting cables through the associated cable glands out of the connection box.
5. Close the connection box.
6. Close off all cable glands with a cover.
7. Remove the four outermost screws used to fasten the connection box.
8. Remove the connection box from its mounting location.

See also

Connecting the KTP Mobile connecting cable to the connection box (Page 73)

Connecting the connection box (Page 59)

Installing system components (Page 43)

Handling the Mobile Panel

4.1 Holding the Mobile Panel and attaching it to the wall-mounting bracket

Holding the HMI device

The figure below shows you how to hold the Mobile Panel on your forearm (here: KTP900F Mobile).



When holding the Mobile Panel as shown, you can, for example, perform movements in the fail-safe automation system during setup mode.

The HMI device is easy to operate when held on the forearm as shown. With your free hand, you can operate all operator controls on the front of the device and the emergency stop / stop button. You can activate the enabling button with the hand holding the HMI device. The enabling button is optimally accessible.

NOTICE

Holding the HMI device during setup mode

Potentially dangerous movements can be controlled manually if setup mode is activated.

To ensure that the emergency stop / stop button and enabling button can be operated quickly in a dangerous situation, the HMI device must be held on your forearm as shown.

If you are only entering data and are not controlling potentially dangerous movements, you can hold the HMI device with both hands on the left and right instead of on your forearm.

Using the HMI device in a fixed position

A wall-mounting bracket is available for securely fixing the HMI device in position. You can place the HMI in the wall-mounting bracket and operate it as a stationary device. Observe the necessary organizational measures as described in the section "Organizational measures (Page 28)".

NOTICE

Operability of the emergency stop / stop button

Placing the HMI device into an unsuitable wall-mounting bracket can impair the operability of the emergency stop / stop button.

Only use the KTP Mobile wall-mounting bracket (Page 21).

Note

If the HMI device with the KTP Mobile connecting cable is not connected to the connection box, the emergency stop / stop button has no function. Potentially dangerous movements cannot be stopped.

The figure below shows an inserted KTP700F Mobile.



- ① HMI device
- ② KTP Mobile wall-mounting bracket
- ③ KTP Mobile connecting cable

4.2 Keyswitches, function keys and illuminated pushbuttons



- ① Keyswitch, for KTP700F Mobile and KTP900F Mobile
- ② Function key blocks
- ③ Illuminated pushbuttons K1 and K2

- **Keyswitch**

The keyswitch is, for example, used to lock functions that can be triggered by the HMI device. The corresponding configuration is described in the section "Evaluating the key-operated switch by means of system functions (Page 188)".

- **Function keys**

The function keys can be used for fast digital input. The function depends on the corresponding project. The corresponding configuration is described in the section "Function keys (Page 204)".

The LED can light up to signal that the corresponding function has been triggered.

- **Illuminated pushbutton**

and can be used for high-speed digital input. The illuminated pushbuttons are momentary action switches without latching mechanism. Lights can signal that the corresponding function has been triggered. The function depends on the corresponding project. The corresponding configuration is described in the section

"Controlling and evaluating the illuminated pushbutton by means of system functions (Page 187)".

Information on the keyswitch of the fail-safe Mobile Panels

- The keyswitch has three switch positions: I, 0 and II.

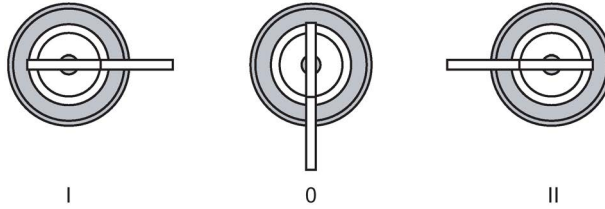

Meaning of the switch positions:

- Switch position I and II: The configured function for this switch position is executed.
- Switch position 0: The called function is canceled.
- Remove the key if you do not use the HMI device.
The key can only be removed in switch position 0.
- The key does not have HMI device-specific coding. You can use the key for any KTP Mobile type HMI device. Spare keys may be ordered as accessories.

See also

Fail-safe KTP Mobile spare key (Page 22)

4.3 Operating the enabling button

The enabling mechanism comprises one integrated enabling button with three settings.

The signals of the enabling button are evaluated internally and sent to the connection box over the connecting cable. For setup mode, these signals must be wired dual-channel from the connection box to the F-system or configured via PROFIsafe.



① Enabling button

For a hardwired F-system: When a SIRIUS safety relay is used, the enabling button meets the requirements of Safety Category 3 in accordance with EN ISO 13849-1.

Requirement

- The HMI device is connected to a correctly installed connection box.
- For a PROFIsafe-based F-system only: A project for PROFIsafe communication has started.

Procedure

1. Press the enabling key to switch position 2 or 3.

Switch position	Function	Enabling button switch status
1	Neutral position	Opened
2	Enable	Closed
3	Panic	Opened

- The figure below shows the switching sequence for normal operation.

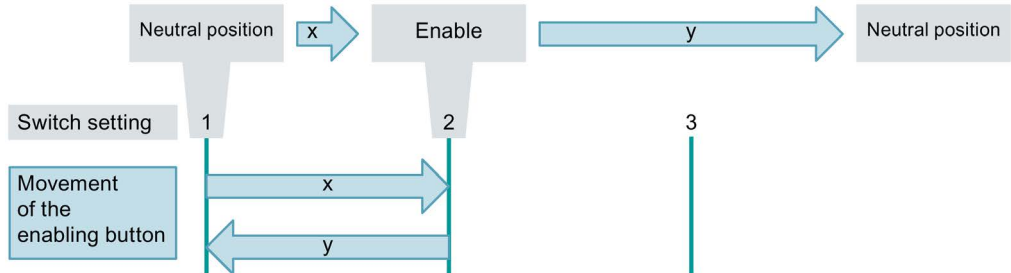

- The figure below shows the switching sequence for panic operation.

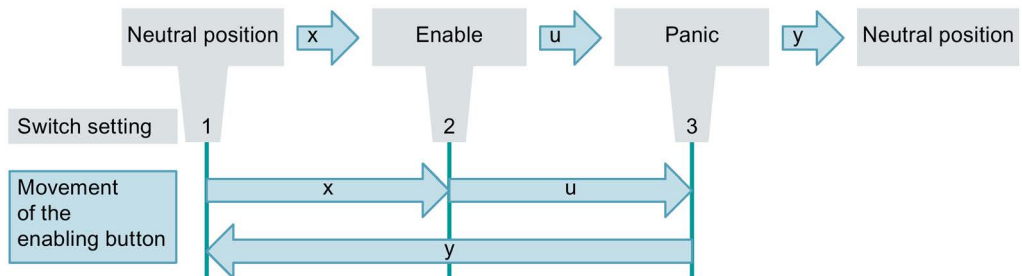

2. Release the enabling button.

If the enabling button is in switch position "3", the "Enable" setting is skipped when the button is released.

Note

Releasing the enabling button and the "Panic" switch position do not require acknowledgement of the safety shutdown.

See also

- Terms for fail-safe operation (Page 24)
- Important notes for the enabling mechanism (Page 40)

4.4 Pressing the emergency stop / stop button

The emergency stop / stop button on the HMI device is an optional operator control. The emergency stop / stop button is designed with two circuits and enables a safety-related emergency stop or stop of the fail-safe automation system.

Note

- Whether the emergency stop / stop button has the "emergency stop" or "stop" function depends on the configuration of the plant and the parameter settings of the HMI device.
 - If the emergency stop / stop button is configured and wired for the "emergency stop" function, the emergency stop / stop button lights up as soon as the "emergency stop" function becomes available.
 - An emergency stop or stop can only be triggered when the fail-safe HMI device is attached to a connection box.
-



- ① Emergency stop / stop button

For a hardwired F-system:

- When a SIRIUS safety relay is used, the emergency stop / stop button meets the requirements of Safety Category 3 in accordance with EN ISO 13849--1.
- When you unplug the connecting cable from the connection box, the emergency stop circuit is either opened or automatically bypassed, depending on the connection box used.

For a PROFIsafe-based F-system: The emergency stop / stop button triggers the configured function.

Requirement

- The HMI device is connected to a correctly installed connection box.
- An operator control for the controlled hot restart of the plant is configured.
- For a PROFIsafe-based F-system only: A project for PROFIsafe communication has started.

Procedure

Note

Only press the emergency stop / stop button to avoid imminent danger. If you want to activate the emergency stop / stop button for test purposes, consult those responsible for the plant in advance.

1. Press the emergency stop / stop button. The system responds with an emergency stop or a stop.
2. Release:

 WARNING
Release requirements If you have operated the emergency stop / stop button and thereby shut down the fail-safe automation system, a situation entailing danger may still remain. You are only allowed to release the emergency stop / stop button under the following conditions: <ul style="list-style-type: none">• The cause of the emergency stop / stop has been eliminated.• A safe hot restart of the fail-safe automation system is possible.

Turn the emergency stop / stop button to release it. The button jumps back to its initial position.

See also

Assigning a safety-related operating mode (Page 142)

SIRIUS safety relays (Page 23)

Terms for fail-safe operation (Page 24)

Important information on emergency stop / stop button (Page 39)

4.5 Testing Mobile Panel readiness for operation

This section describes how to check the operational readiness of the Mobile Panel after you have connected the connecting cable and, if necessary, a memory card to the Mobile Panel. You can find a description of the PROFIsafe communication in the section "Fail-safe operation (Page 209)".

Requirement

- A connection box compatible with the HMI device is in place and ready for operation. See "Mobile Panel and connection box compatibility (Page 29)".

Procedure

Switching on

1. Plug the connecting cable into the connection box.

If the HMI device does not start, the wires at interface X10 in the connection box may have been crossed. Check the connected wires and change the connections if necessary.

When plugging and unplugging the connecting cable, follow

"Connecting the KTP Mobile connecting cable to the connection box (Page 73)".

The HMI device display lights up once the cable is connected. A start screen is displayed during startup. The desktop with the Start Center is then displayed, see section "Desktop and Start Center (Page 87)".

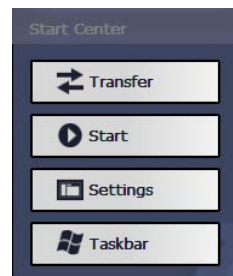

The following dialog then appears:

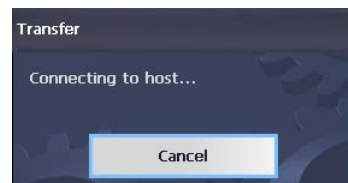

2. Press "Cancel" to stop the transfer.

Note

When you restart the HMI device, a project may already be loaded. The system then skips "Transfer" mode and starts the project. Use the relevant operator control to close the project. Please refer to your plant documentation for additional information.

4.5 Testing Mobile Panel readiness for operation

The HMI device automatically switches to "Transfer" mode if the following requirements have been met:

- No project is loaded on the device
- At least one data channel has been configured

3. If this involves a fail-safe Mobile Panel, the "Safety operation" dialog is displayed.

The dialog is displayed if the connection box has not been configured. The dialog does not open if the HMI device is connected to a configured connection box.

You can find additional information in the section "Assigning a safety-related operating mode (Page 142)".

The HMI device is ready for operation when one of the following states is indicated:

- The Start Center is displayed.
- The "Transfer" dialog is displayed.
- A project is started.

Testing the enabling button and emergency stop / stop button function

Note

Before testing the enabling button and emergency stop / stop button functions, read the information in the following sections:

- "Operating the enabling button (Page 81)"
 - "Pressing the emergency stop / stop button (Page 83)".
-

The HMI device must be connected to a connection box for the function test.

1. Press down the enabling button until it engages.

Check whether the plant switches to the safe operating state described in the plant documentation.

2. Press the emergency stop / stop button.

Check whether the system switches to the safe operating state as specified in the plant documentation.

Switch off

1. Close the project running on the HMI device.

For a PROFIsafe-based F-system: Confirm the logoff.

2. Pull out the connecting cable from the connection box.

The display switches off. If you do not plug in the connecting cable within the next 5 minutes, the HMI device switches off.

Parameterizing the Mobile Panel

5.1 Firmware and software

Firmware and software for your HMI device are continually undergoing further development. Check regularly whether software updates or patches are available for your HMI device and install the latest versions.

You can find the latest updates and patches for your HMI device on the Internet (<https://support.industry.siemens.com/cs/ww/en/>). Enter the article number of your HMI device as a search term and filter the contributions according to the by contribution type "Download".

5.2 Desktop and Start Center

Once the HMI device has been started, the display shows the desktop.

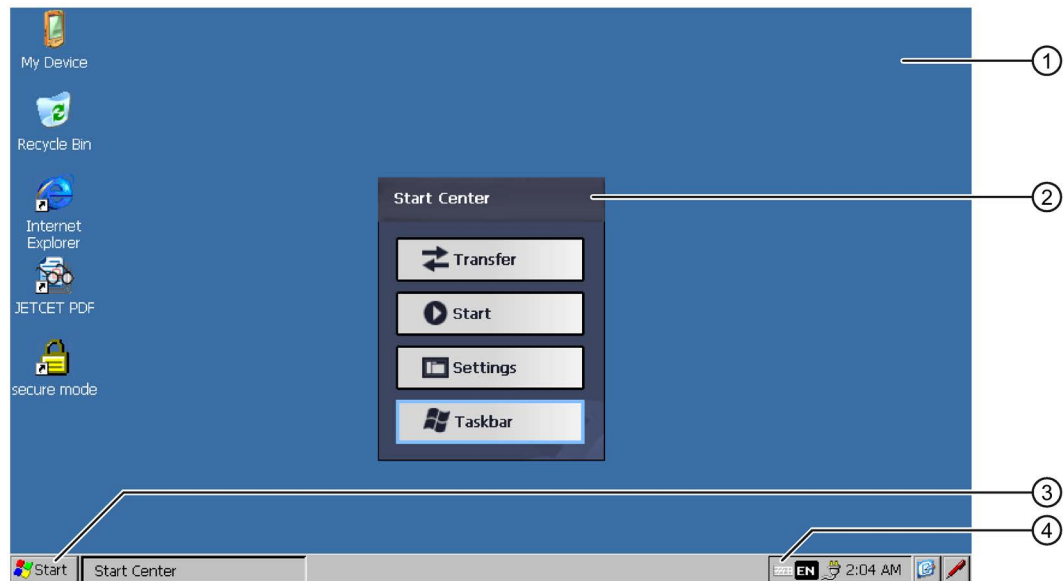

- ① Desktop
- ② Start Center
- ③ Start menu
- ④ Icon for screen keyboard

The Start Center

The Start Center buttons have the following function:

- **Transfer** – You switch the HMI device to "Transfer" mode. The transfer is only activated if at least one data channel has been parameterized, see section "Parameterizing Transfer (Page 109)".

- Start – You start the project on the HMI device.
If you do not perform an operation, a project already loaded on the HMI device will start automatically in line with the settings in the Control Panel . If no project is loaded, the Start Center will activate the transfer.
- Settings – You start the Control Panel.
See section "Overview of functions (Page 91)".
- Taskbar – You open the task list and the Start menu.

The Start Center is displayed again if a project on the HMI device has been closed or if it is accessed from the project.

5.3 Operating the desktop, Start Center and Control Panel



You can operate the Windows CE user interface and the Start Center with the touch screen.

The operator controls shown in the dialogs are touch-sensitive. Touch objects are operated in the same way as mechanical keys. You activate an operator control by pressing it with your finger. To double-click, touch an operator control twice in succession.

5.4 Installed programs

Installed programs

The following programs are installed on the HMI device:

Installed programs	Icon	File formats
PDF Viewer		PDF
Internet Explorer		HTML

The programs can be found on the desktop or in the Start menu under "Programs". Each of these programs can also be opened from the HMI project if this has been configured.

The PDF viewer features a zoom function. You can find additional information on the programs on the Microsoft website.

Internet Explorer

Internet Explorer for Windows CE is installed on the HMI device.

The Internet Explorer for Windows CE differs in functionality from the Internet Explorer of the MS operating systems. Internet Explorer for Windows CE has separate proxy settings that are independent of the settings described in the section "Setting the proxy server (Page 120)".

5.5 Security mode

5.5.1 Overview

You can protect the desktop icons, the taskbar and the "Settings" and "Taskbar" buttons in the Start Center from unauthorized access. Security mode prevents unauthorized access.

Security mode can be activated if you have assigned a password as described in the section "Entering and deleting a password (Page 105)". If the password is not entered, only the "Transfer" and "Start" buttons can be operated.

NOTICE

Keeping the password

If the password is no longer available, you have no access to the Control Panel and the Windows CE taskbar. Backup password to protect it against loss.

5.5.2 Using the HMI device in password-protected security mode

If security mode has been activated, only the "Transfer" and "Start" buttons can be operated without a password. To deactivate security mode, delete the password as described in "Entering and deleting a password (Page 105)".

Requirement

- A password has been assigned as described in "Entering and deleting a password (Page 105)".
- The security mode is displayed, similar to the figure below:

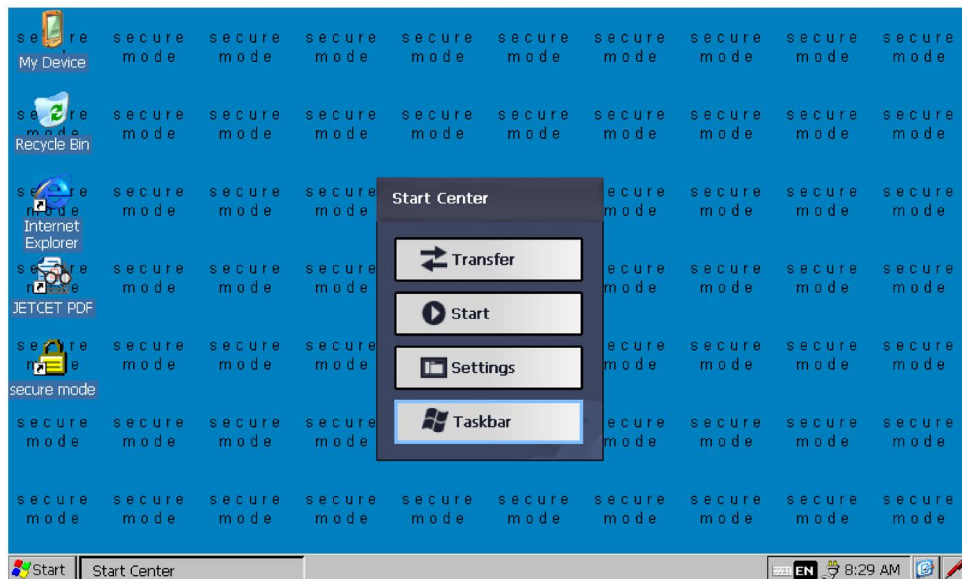

Procedure

1. Operate a password-protected desktop icon, the taskbar or the "Settings" or "Taskbar" button in the Start Center.

The following dialog appears:



2. Enter the required password.
3. Confirm your entry with "OK".

The dialog will close and the selected operator control open.

5.6 Control Panel

5.6.1 Opening the settings

The Control Panel can be opened as follows:





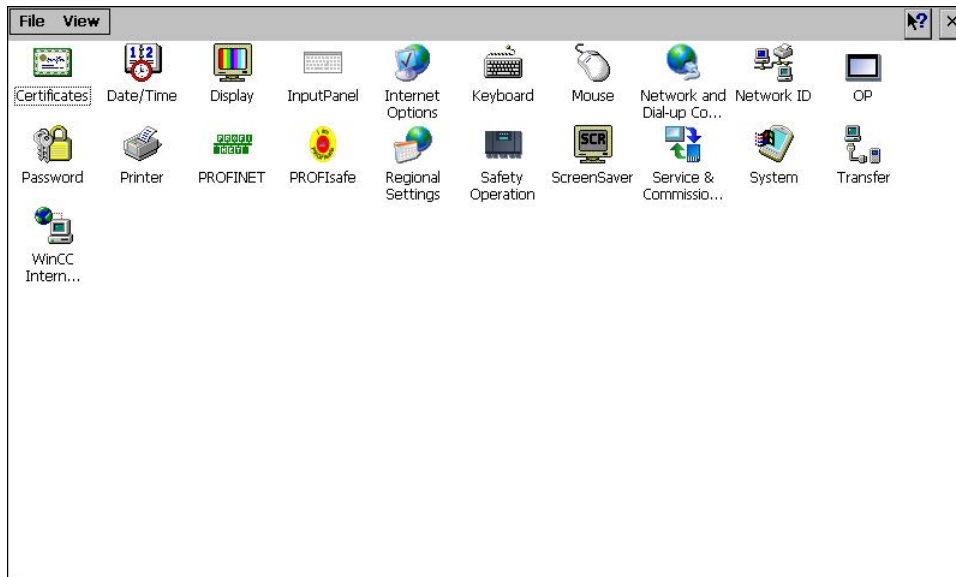











- With the "Settings" button in the Start Center.
- In the Windows CE start menu with "Settings > Control Panel".





The figure below shows the open Control Panel.



5.6.2 Overview of functions

The table below shows the icons of the Control Panel and provides links to the corresponding function descriptions in the appropriate sections.

Icon	Functional description
	Importing, displaying and deleting certificates (Page 124)
	Setting the date and time (Page 104)
	Changing display brightness (Page 96)
	Configuring the screen keyboard (Page 97)
	Changing general settings (Page 119)
	Setting the proxy server (Page 120)
	Changing Internet security settings (Page 121)
	Activating encryption protocols (Page 123)
	Setting the character repeat rate of the screen keyboard (Page 98)
	Setting the double-click (Page 99)
	Specifying the IP address and name server (Page 132)
	Specifying the logon data (Page 133)
	Backing up registry information and temporary data (Page 115)
	Displaying information about the Mobile Panel (Page 118)
	Restarting the HMI device (Page 101)
	Display firmware (Page 118)
	Calibrating the touch screen (Page 100)
	Activate/deactivate retentivity of the alarm buffer on the HMI device (Page 113) ¹
	Entering and deleting a password (Page 105)
	Changing the print options (Page 116)
	Enabling NTP (Page 127)
	Enabling PROFINET (Page 126)
	Setting the PROFIsafe address (Page 129)
	Regional and language settings (Page 103)
	Assigning a safety-related operating mode (Page 142)
	Setting the screen saver (Page 107)

Icon	Functional description
	Saving to external storage medium – backup (Page 144)
	Restoring from external storage medium – Restore (Page 147)
	Update operating system (Page 149)
	Load project from external storage medium (Page 152) ²
	Using automatic backup (Page 155)
	Editing IP addresses and communication connections (Page 159)
	Displaying general system properties (Page 117)
	Displaying the memory distribution (Page 111)
	Specifying the computer name of the HMI device (Page 131)
	Parameterizing Transfer (Page 109)
	Setting the project storage location and start delay (Page 111)
	Configuring e-mail (Page 134)
	Configuring Telnet for remote control (Page 136)
	Configure Sm@rt Server (Page 136)
	Configure Web Server (Page 140)

- ¹ Available in connection with an HMI device image that is compatible with WinCC (TIA Portal) V15.1 or higher.
- ² Available in connection with an HMI device image that is compatible with WinCC (TIA Portal) V14 or higher.

5.6.3 Operating the Control Panel

You can operate the Control Panel using the touch screen. The following steps give a general description of how to operate a function.

Requirement

- The current project has been closed.
- The Start Center is displayed.

Procedure

1. Open the Control Panel using the "Settings" button.
2. Double-click an icon. The corresponding dialog is displayed.
3. Select a tab.
4. Make the desired settings. When you navigate to an entry field, the screen keyboard opens.
5. Your settings are applied with the  button.

To cancel the entry, press the  button. The dialog closes.

6. To close the Control Panel, use the  button.
The Start Center is displayed.

See also

Configuring the screen keyboard (Page 97)

5.6.4 Display types for the screen keyboard

The screen keyboard is used for entering alphanumeric, numeric and special characters. As soon as you touch a text box, a numeric or alphanumeric screen keyboard is displayed, depending on the type of the text box.

You can also open the screen keyboard by selecting the icon in the status bar. The icon is shown in the figure in section "Overview of functions (Page 91)".

The procedure for setting the screen keyboard is described in the section "Configuring the screen keyboard (Page 97)".

Representation types for the screen keyboard

You can toggle the screen keyboard display as follows.

Alphanumerical screen keyboard

The alphanumerical screen keyboard has the following levels.

- Normal level
 - HMI device with 4" display



- HMI device with 7" display diagonal or larger

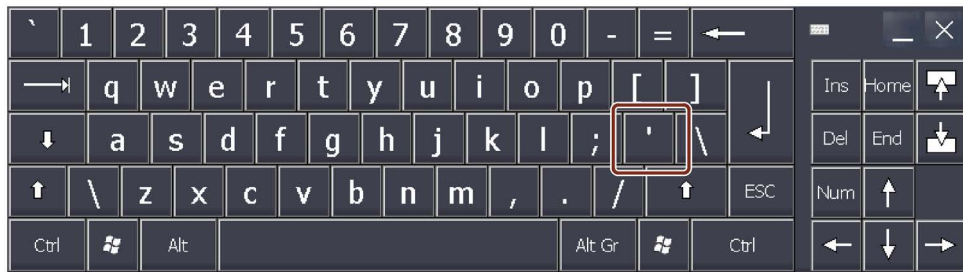

Note

The ' character on the keyboard is only displayed when followed by a space. If the ' character is followed by a letter, then the result will be an accent, such as "á".

- Shift level
 - The shift level has uppercase letters and other special characters.

The alphanumerical keyboard is always displayed after a restart.

Numerical screen keyboard

By pressing the "Num" button, you can switch between the numerical and alphanumerical screen keyboard.











Reduced screen keyboard





You activate the reduced screen keyboard with the  key. The minimized screen keyboard is displayed as follows:



Changing the display of the screen keyboard

Key	Function
	Switching between the numerical and alphanumerical keyboard
	Switching between the normal level and Shift level of the alphanumerical screen keyboard
	Switchover to special characters
	Switching from full display to reduced display
	Switching from reduced display to full display
	Closing of reduced display of the screen keyboard
	Brief touch: Hide screen keyboard Long touch and move at the same time: Move the screen keyboard
	Scaling the screen keyboard. Only available for devices as of a display size of 7" and when the "Show Resize button" option is activated, see section "Configuring the screen keyboard (Page 97)".
	Touch twice: The taskbar opens

Entering data

Key	Function
	Delete character left of cursor
	Delete character right of cursor
	Confirm input
	Cancel input

5.7 Configuring operation

5.7.1 Changing display brightness

You can use this function to change the brightness of the display by changing the intensity of the backlighting. The intensity of the backlighting can be adjusted with a slider or with the "Reduce brightness" and "Increase brightness" keys.

NOTICE

Reducing backlighting

The brightness of the backlighting decreases with increasing service life. To avoid shortening the service life of the backlighting unnecessarily, set a reduction of the backlighting.

Requirement

The Control Panel is open.

Procedure



1. Open the "Display Properties" dialog using the "Display" icon.

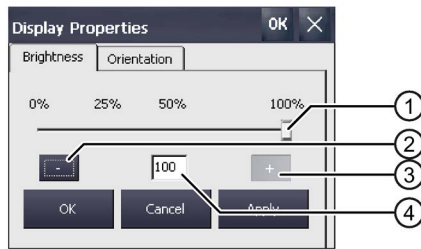

- ① Slider
- ② Reduce brightness
- ③ Increase brightness
- ④ Indicates the set value

2. To increase the brightness, press "+".
The brightness changes by 5% each time you press the key. Maximum possible value: 100%
3. To reduce the brightness, press "-".
Smallest value that can be set: 25%
4. To check the setting, press "Apply".
The set brightness value is applied.
5. Confirm your entry with "OK".
The dialog closes.

The brightness of the display has been changed.

5.7.2 Configuring the screen keyboard

You can use this function to change the size and the position of the screen keyboard.

Requirement

The Control Panel is open.

Procedure



1. Open the "Siemens HMI Input Panel" dialog using the "Input Panel" icon.

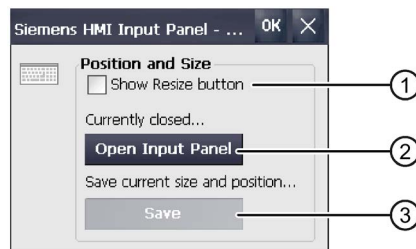

- ① Check box for displaying the "Resize"  button in the screen keyboard, not with 4" devices
- ② Button for opening the screen keyboard
- ③ Button for saving the current position and size of the screen keyboard

2. If you prefer a scalable screen keyboard, activate the check box "Show Resize Button".

If "Show Resize Button" is activated, the "Resize"  button is displayed in the open screen keyboard.

This function is not available for 4" HMI devices.

3. If you want to check the settings, open the screen keyboard with the "Open Input Panel" button. Set the required size and position of the screen keyboard using the following buttons of the screen keyboard:

- Scale the screen keyboard by pressing the "Resize"  button and moving it.

This function is not available for 4" HMI devices.

- Position the screen keyboard by pressing the "Input Panel"  button and moving it.

4. Use the "Save" button to save the current settings for size and position of the screen keyboard.

5. Confirm your entries with "OK".

The dialog closes.

The screen keyboard settings have been modified.

5.7.3 Setting the character repeat rate of the screen keyboard

You can use this function to set the character repeat and repeat delay for the screen keyboard.

Requirement

The Control Panel is open.

Procedure



1. Open the "Keyboard Properties" dialog using the "Keyboard" icon.

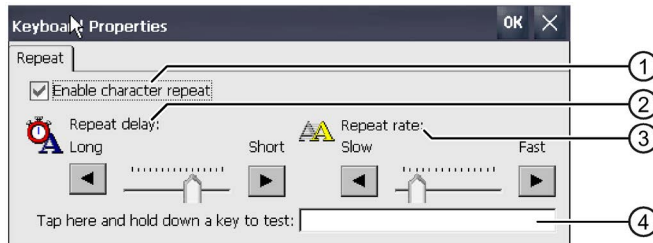

- ① Check box for selecting the character repeat
- ② Slider control and buttons for the delay time before character repeat
- ③ Slider control and buttons for the rate of the character repeat
- ④ Test box

2. If you want to enable character repetition, select the "Enable character repeat" check box.
3. To change the delay, press a button or the slider in the "Repeat delay" group. Moving the slider to the right reduces the delay. Moving it to the left extends the delay time.
4. To change the repeat rate, press a button or the slider in the "Repeat rate" group. Moving the slider to the right speeds up the repeat rate. Moving to the left will slow down the repeat rate.
5. Check the settings for the touch control by touching the test field. The screen keyboard is displayed.
6. Move the screen keyboard as needed.
7. Press a key for a character and keep the key pressed. Check that character repetition occurs and the rate of the character repetition in the test field.
8. If the settings are not ideal, correct them.
9. Confirm your entries with "OK". The dialog closes.

The character repetition and delay are set.

5.7.4 Setting the double-click

You start applications in the Control Panel and in the operating system with a double-click. A double-click corresponds to two brief touches.

In the "Mouse Properties" dialog, make the following settings for operation with the touch screen:

- Interval between two touch contacts on the touch screen
- Interval between the two clicks of a double-click

Requirement

The Control Panel is open.

Procedure



1. Open the "Mouse Properties" dialog using the "Mouse" icon.

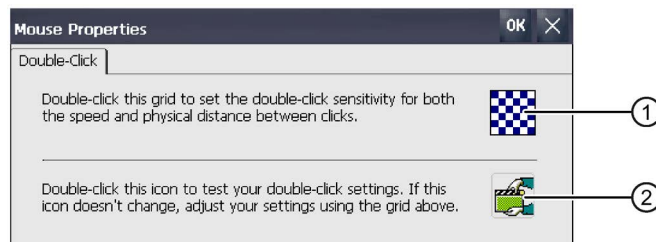

- ① "Checkered pattern" icon
- ② "Test" icon

2. Double-click the "Checkered pattern" icon.
After the double-click, the colors in the pattern are inverted. White boxes become gray. The timeframe for the double-click is saved.



3. Check the double-click: Press the "Test" icon twice in succession. If the double-click is recognized, the "Test" icon is displayed as follows:



4. Repeat steps 2 and 3 as necessary until the settings are okay.
5. Confirm your entry with "OK".
The dialog closes.

The double-click adjustment is completed.

5.7.5 Calibrating the touch screen

Parallax may occur on the touch screen depending on the mounting position and perspective. To prevent any resulting operating errors, you may need to calibrate the touch screen.

Requirements

- A touch pen
- The Control Panel is open.

Procedure



1. Open the "OP Properties" dialog using the "OP" icon.
2. Change to the "Touch" tab.



3. Press the "Recalibrate" button.
The following dialog is displayed:

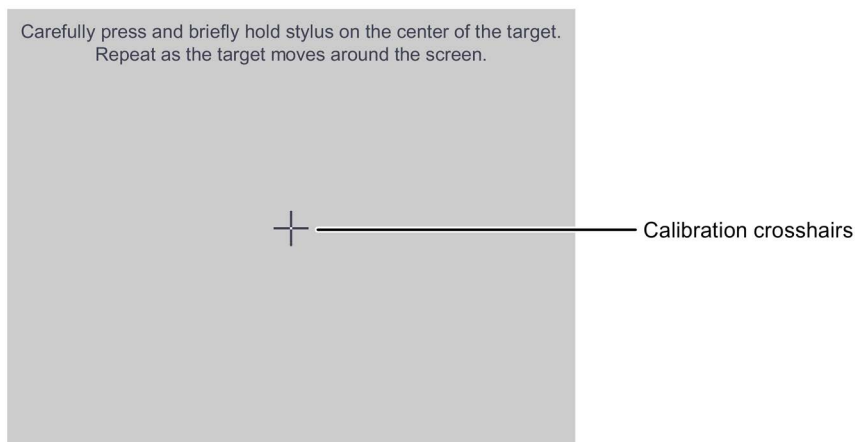

4. Touch the center of the calibration cross until it is shown at the next position. The calibration cross appears at four other positions.
Once you have touched the calibration cross at all positions, the following dialog appears:

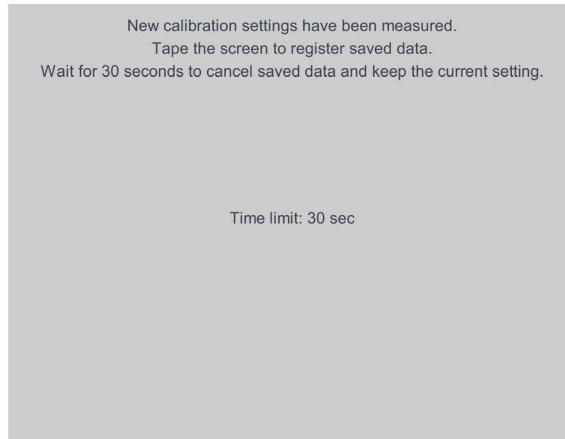

5. Touch the touch screen within the indicated time.
The calibration will be saved. The "Touch" tab is displayed once again in the "OP Properties" dialog. If you do not touch the touch screen within the time shown, your original setting will be retained.
6. Close the "OP Properties" dialog with "OK".

The touch screen of the HMI device is calibrated.

5.7.6 Restarting the HMI device

You need to perform a restart in the following situations:

- You have enabled or disabled the PROFINET IO direct keys, see section "Enabling NTP (Page 127)".
- You have changed the time zone and activated daylight saving time, see section "Setting the date and time (Page 104)".
- You have changed the settings for the screensaver, see section "Setting the screen saver (Page 107)".
- You have changed the retentivity behavior of the alarm buffer, see section "Activate/deactivate retentivity of the alarm buffer on the HMI device (Page 113)".

NOTICE

Data loss

All volatile data is lost with a restart.

Make sure that no project is running on the HMI device and no data is being written to the flash memory.

Requirement

- If you want to restore the factory settings: The HMI device is connected in accordance with "Connecting a Configuring PC (Page 54)".
- PROFIsafe-based F-system: PROFIsafe communication was terminated.
- The Control Panel is open.

Procedure



1. Open the "OP Properties" dialog using the "OP" icon.
2. Change to the "Device" tab.

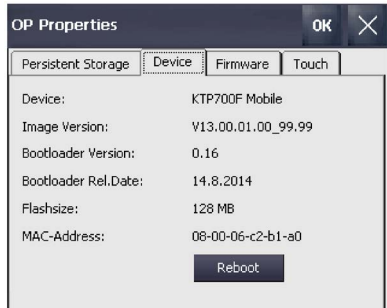

3. Click the "Reboot" button.

The following dialog appears:



- ① Button for restart
- ② Button for restoring factory settings and subsequent restart

4. Press one of the following buttons:
 - "Reboot": Restart the HMI device immediately.
 - "Prepare for Reset": Reset the HMI device to factory settings.

Note

Press "Prepare for Reset" to delete the operating system and project data.

Restore the operating system as described in the section "Reset to factory settings with ProSave (Page 198)".

- "No": Do not perform a restart, close the dialog.

See also

Desktop and Start Center (Page 87)

5.8 General settings

5.8.1 Regional and language settings

The date, time and decimal points are displayed differently in different countries. You can adapt the display format to meet the requirements of various regions. The country-specific settings apply to the current project. If the project language is changed, the country-specific settings are also changed.

Requirement

The Control Panel is open.

Procedure



1. Open the "Regional and Language Settings" dialog using the "Regional Settings" icon.

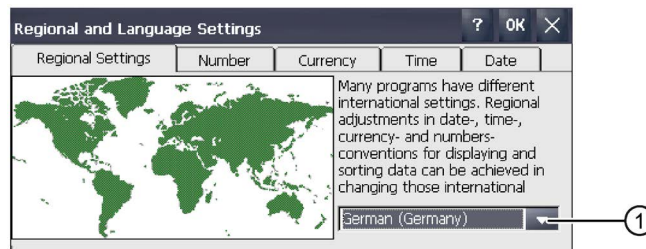

① "Region" selection box

2. Select the required region in the selection box ①.
3. Navigate to the "Number", "Currency", "Time" and "Date" tabs one after the other.
4. Set the required regional settings in the selection field of these tabs.
5. Confirm your entries.
The dialog closes.

The country-specific specifications for the HMI device are now set.

"Setting the date and time (Page 104)" describes how to activate daylight saving time.

5.8.2 Setting the date and time

You can use this function to set the date and time. The HMI device has an internal buffered clock.

Requirement

The Control Panel is open.

Procedure



1. Open the "Date/Time Properties" dialog using the "Date/Time" icon.

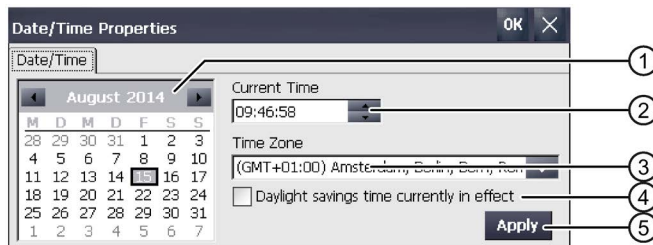

- ① Date selection box
 - ② Text box for the time
 - ③ Time zone selection box
 - ④ Check box for activating and deactivating daylight saving time
 - ⑤ Button for applying changes
2. Select the applicable time zone for the HMI device from the "Time Zone" selection box.
 3. Press the "Apply" button.
The time of day shown in the "Current Time" field is adjusted correspondingly to the selected time zone.
 4. Set the date in the selection box.
 5. Set the current time of day in the "Current Time" entry field.
 6. Press the "Apply" button.
The entry is applied.

Note

The system does not automatically switch between standard time and daylight saving time.

7. If you want to switch from standard time to daylight saving time, select the "Daylight savings time currently in effect" check box.
With "Apply", the time of day is set one hour ahead.
8. If you want to switch from daylight saving time to standard time, clear the "Daylight savings time currently in effect" check box.
With "Apply", the time of day is set back one hour.
9. Confirm your entries.
The dialog closes.

The settings for the data and time of day have now been changed. The HMI device must be restarted after changes in the following cases:

- You have changed the time zone setting
- You have changed the "Daylight savings time currently in effect" check box setting

See "Restarting the HMI device (Page 101)".

Synchronizing the date and time with the PLC

The date and time of the HMI device can be synchronized with the date and time in the PLC if this has been configured in the project and the control program. Additional information is available here:

"SIMATIC Safety - Configuring and Programming" programming and operating manual (<http://support.automation.siemens.com/WW/view/en/54110126>)

NOTICE

Synchronizing the date and time

If the data and time is not synchronized and time-based reactions are triggered by the HMI device, malfunctions in the PLC may occur.

Synchronize the date and time if time-based reactions are triggered in the PLC.

5.8.3 Entering and deleting a password

You can set and delete passwords with the following procedure:

- For security mode, as described in the section "Using the HMI device in password-protected security mode (Page 89)".
- For security-related mode, as described in the section "Assigning a safety-related operating mode (Page 142)".

Requirement



- A password that does not contain the following characters:
 - Blank
 - The special characters ' or "
- Password length ≤ 12 characters

NOTICE

Keeping the password

If the password is no longer available, you have no access to the Control Panel and the Windows CE taskbar.

Backup password to protect it against loss.

Procedure

Setting up password protection

1. Double-click on the "Password" icon.

The following dialog appears:

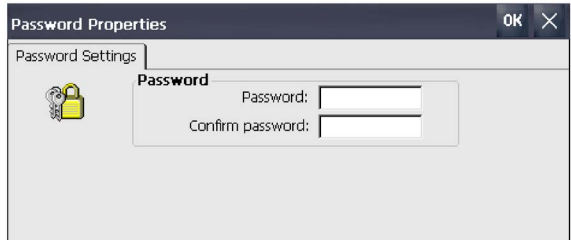

2. Enter the password in the "Password" text box.
Activate the numeric keyboard on the screen for this.
3. Repeat the password entry in the "Confirm password" text box.
4. Confirm the inputs.
The dialog and the screen keyboard close.

Security mode as described in the section "Using the HMI device in password-protected security mode (Page 89)" is active.

Canceling password protection

1. Double-click on the "Password" icon.

The following dialog appears:



2. Enter the password in the "Password" text box.
The following dialog appears:

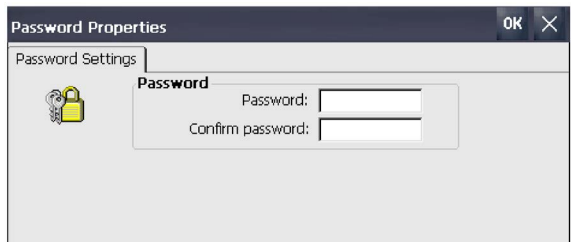

3. Delete the entry in the "Password" text box.
The entry in the "Confirm password" text box is deleted automatically.
4. Confirm the deletion.
The dialog and the screen keyboard close.

Security mode as described in the section "Using the HMI device in password-protected security mode (Page 89)" is **not** active.

5.8.4 Setting the screen saver

You can set the following time intervals in the Control Panel:

- Automatic activation of the screen saver
- Automatic reduction in the display backlighting

The HMI device exhibits the following behavior based on the settings:

- The screen saver is automatically activated if the HMI device is not operated within the specified period of time.
- Touching the touch screen switches off the screen saver. If you touch a button at the same time, the function assigned to the button is not executed. In addition, the reduction of the backlighting according to the settings of the screen saver is canceled.

NOTICE

Activating the screen saver

Display content that is not changed for a long period can remain dimly visible in the background for a long time. This effect is reversible when you use a screen saver with moving image. Therefore, activate the screen saver of the type "Standard (Flying Windows)".

Requirement

The Control Panel is open.

Procedure



1. Open the "Screensaver" dialog using the "ScreenSaver" icon.

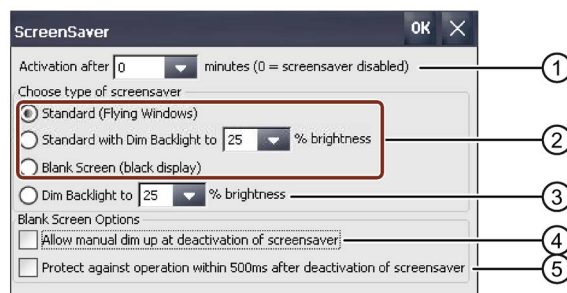

- ① Period of time in minutes before the screen saver is activated
- ② Type of screen saver
- ③ Reduced backlighting to a specified value
- ④ Allow dimming when deactivating the "Blank Screen" screen saver
- ⑤ Short-term operation lock after deactivating the "Blank Screen" screen saver

2. Enter the number of minutes after which the screen saver is to be activated.
The minimum setting is 1 minute and the maximum setting is 360 minutes. Entering "0" disables the screen saver.
3. Select the type of screen saver:
 - Use the "Standard" option to enable the default screensaver.
 - Using the option "Standard with Dim Backlight" you activate the Windows standard screensaver and reduce the backlight to a value between 25% and 90%.
If you enter a value outside the range of 25 to 90%, a message will appear and the value is reset to 25%.
 - Use the option "Blank Screen" to activate the disabling of the backlighting of the device.
4. Using the option "Dim Backlight to" you reduce the backlight to a value between 25% and 90%, without activating a screen saver.
If you enter a value outside the range of 25 to 90%, a message will appear and the value is reset to 25%.
5. The "Allow manual dim up at deactivation of screensaver" for the "Blank Screen" screen saver works as follows:
 - If the option is activated, you can dim the display brightness on deactivation of the screen saver. The brightness is increased as long as you keep pressing the touch screen.
 - If the option is deactivated, the brightness is increased to the value that was set prior to activation of the screen saver when you touch the touch screen.
6. If you want to delay touch operation for a brief time following deactivation of the "Blank Screen" screensaver, for example, to prevent incorrect operator inputs in connection with option ④, select the "Protect against operation within 500 ms after deactivation of screensaver" check box.
7. Confirm your entries.
The dialog closes.

The screen saver for the HMI device has now been set. You will need to restart the HMI device after the screen saver has been activated. The screen saver is then enabled.

5.8.5 Parameterizing Transfer

A project can only be transferred from the configuration PC to the HMI device when at least one data channel is configured and enabled on the HMI device. Follow the procedure below to configure transfer mode.

If you block all data channels, the HMI device is protected against unintentional overwriting of the project data and HMI device image.

Requirement

The Control Panel is open.

Note

If you change the transfer settings while a transfer is in progress and want to confirm with "OK", an error message is displayed.

Procedure



1. Open the "Transfer Settings" dialog using the "Transfer" icon.

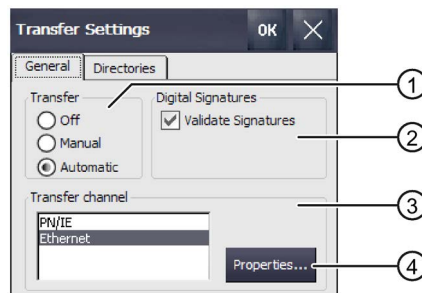

- ① Transfer group
- ② Digital signatures group
- ③ Transfer channel group
- ④ Button for parameter assignment of the transfer channel properties

2. Change to the "General" tab.
3. In the "Transfer" group, select whether you want to enable or disable "Transfer" mode.

Select one of the following options:

- Off – Transfer is not possible
- Manual – Manual transfer
If you want to initiate a transfer, close the active project and press the "Transfer" button in the Start Center.
- Automatic – Automatic transfer
A transfer can be remotely triggered from a configuration PC or a programming device. The running project is closed immediately in this case and the transfer is started.

 WARNING
Unintended reactions during automatic transfer
When an automatic transfer starts and the running project is closed immediately, this could cause unintentional reactions to be triggered in the plant. This can result in personal injury or material damage.
Take the following measures to prevent undesired reactions in the plant:
<ul style="list-style-type: none">• Select the "Off" or "Manual" setting for "Transfer" after the commissioning phase.• Assign a password in the Control Panel to restrict access to the transfer settings by unauthorized persons.

Note

The "Automatic" option is not available for fail-safe HMI devices.

4. "Digital signatures" group:

To select the check of the signature during transfer of an HMI device image, select the "Validate Signatures" check box. This function is available in connection with an HMI device image that is compatible with WinCC (TIA Portal) V14 or higher. Image signatures are checked starting with V14. If you transfer an image that is compatible with a version before V14, an error message is displayed.

To transfer an unsigned image that is compatible with a version before V14, clear the "Validate Signatures" check box.

5. Select the required data channel in the "Transfer channel" group.

- PN/IE

The transfer takes place over PROFINET or Industrial Ethernet. An HMI device can communicate as follows:

- With a PLC directly via routing
- Over a switch or over a router in the local network
- Ethernet

6. To call up the addressing of the HMI device, press "Properties".

You can find the necessary information in "Specifying the IP address and name server (Page 132)".

7. Confirm your entries with "OK".

The dialog closes.

The data channel for transfer is configured.

See also

Starting the transfer (Page 191)

5.8.6 Storage management

5.8.6.1 Displaying the memory distribution

This function displays the size of the flash memory and its archived data and program data allocation.

Requirement

The Control Panel is open.

Procedure



1. Open the "System Properties" dialog using the "System" icon.
2. Change to the "Memory" tab.

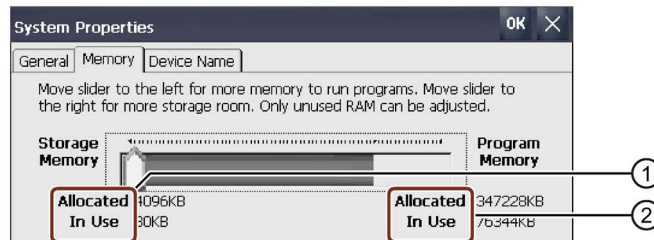

- ① Cache memory, available and used
- ② RAM, available and used

NOTICE

Malfunction

If you change the allocation of the memory, malfunctions may occur.

Do not change the memory allocation in the "Memory" tab unless the message "Insufficient memory" is displayed.

Additional information is available in the information system of the TIA Portal.

5.8.6.2 Setting the project storage location and start delay

There are various storage locations available for storing the compressed source file of your project, for example, the external memory card or a network drive. This section describes how to set the location and configure the delay time for the project start.

Requirement

The Control Panel is open.

Procedure



1. Open the "Transfer Settings" dialog using the "Transfer" icon.
2. Change to the "Directories" tab.

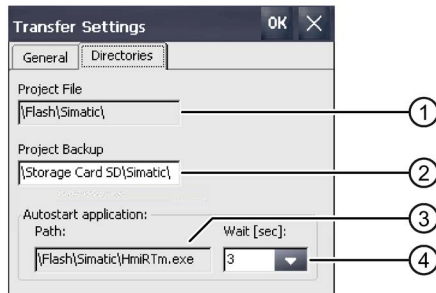

- ① Storage location for project file, cannot be set
- ② Directory where the compressed source file of your project is saved
- ③ Storage location and initialization file for process operation, cannot be set
- ④ Delay time for project start

3. Select a memory location from the "Project Backup" text box.

The storage location can be a storage medium or the local network. During the next backup process, the project's source file is stored in the specified location.

4. Select the desired delay time for project start from the "Wait [sec]" selection box.

The delay time sets how long the Start Center is displayed before the project starts. Permissible values are 1, 3, 5 and 10 seconds, for HMI device image versions $\geq V14$ SP1 additionally: 60 seconds.

You can also select:

- 0 seconds
The project starts immediately. The Start Center is **not** displayed.
- Forever
The project does not start. The Start Center is displayed permanently.

Note

For the Start Center to be accessed after the project starts, an operating element must be configured in the project with the "Close project" function.

5. Confirm your entries with "OK".

The dialog closes.

The storage location and delay time for the HMI device are now set.

5.8.6.3 Activating memory management

Note

Memory management

If you do not activate memory management, undefined states can occur during the runtime of the project.

Requirement

The Control Panel is open.

Procedure

Proceed as follows:

1. Open the "OP Properties" dialog using the "OP" icon.
2. Change to the "Memory Monitoring" tab.

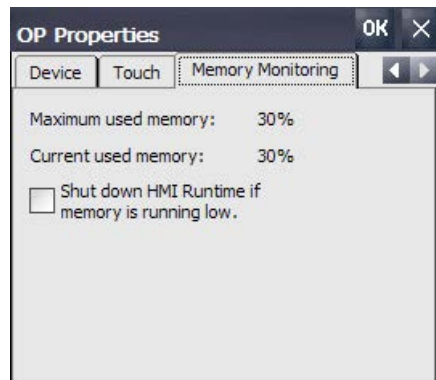

3. If you want to enable memory management, select "Shut down HMI Runtime...".
4. Confirm your entries with "OK".

Result

Memory management is activated. An open project is closed under these circumstances:

- Insufficient RAM
- RAM needs to be reorganized

An alarm is then triggered on the HMI device. Restart the project on the HMI device.

5.8.6.4 Activate/deactivate retentivity of the alarm buffer on the HMI device

This function is available in connection with an HMI device image that is compatible with WinCC (TIA Portal) V15.1 or higher.

You can use this function to activate or deactivate the retentive alarm buffer. The default setting is "activated".

When the retentivity of the alarm buffer is activated, the retentive alarm data is backed up every two seconds to the internal flash memory of the HMI device. With a high number of alarms, the internal flash memory is subject to an equally high number of read and write cycles.

If the retentivity of the alarm buffer is deactivated, the alarm buffer is emptied and the retentive alarm data is no longer backed up to the internal flash memory. This means the internal flash memory is used less with a high number of alarms.

Note

Safety-related alarms are also affected

If the retentivity of the alarm buffer is deactivated, safety-related alarms too are no longer backed up to the internal flash memory.

Backing up data before deactivating the retentivity

When you deactivate the retentivity of the alarm buffer and still need the data in the alarm buffer, back up this data before deactivating the retentivity in a log.

Changing the retentivity behavior using the configuration

As of WinCC (TIA Portal) V15.1 you can also change the retentivity behavior with the "Persistent alarm buffer" function under "Runtime settings > Alarms > General". Default setting in the configuration is "activated". For the project transfer, the setting is applied from the configuration in the Control Panel. If you change the setting in the Control Panel after the project transfer, the changed setting is retained until the next project transfer.

Requirement

The Control Panel is open.

Procedure

Proceed as follows:

1. Open the "OP Properties" dialog using the "OP" icon.
2. Change to the "Message Buffer" tab.

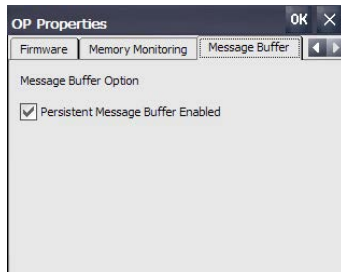

3. You activate or deactivate the retentive message buffer with the "Persistent Message Buffer Enabled..." option, default setting is "activated".
4. Confirm your entries with "OK".
5. Restart the HMI device, see section "Restarting the HMI device (Page 101)".

5.8.7 Backing up registry information and temporary data

You can install and uninstall your own software on and from the HMI device. You need to back up the registry settings to flash memory after installation or removal.

You can also save the data in the memory buffer to flash memory.

Requirement

The Control Panel is open.

Procedure



1. Open the "OP Properties" dialog using the "OP" icon.

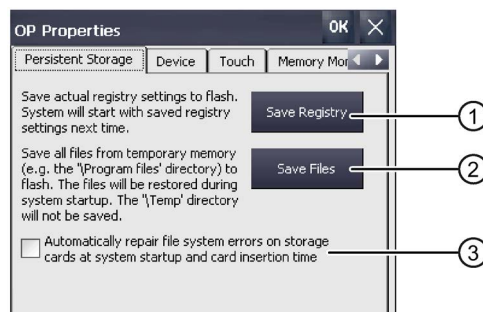

- ① Button for saving registry information
- ② Button for saving temporary files
- ③ Automatically repairs file system errors on plug-in storage media during HMI device startup and when a storage medium is inserted.

2. To back up the current registry entries, press the "Save Registry" button.
The current registry entries will be backed up in the flash memory. The HMI device loads the saved registry information the next time it boots.
3. To back up temporary files, press the "Save Files" button.
All files from the temporary memory will be backed up in the flash memory. You can access the files saved under "Start > Documents". These files are written back when the HMI device is started. The "\Temp" directory is not saved.
4. If you want file system errors on the memory card to be repaired automatically, select the "Automatically repair file ..." check box.
If the check box is cleared, a necessary repair of the file system on memory cards is only performed on request.
5. Confirm your entries with "OK".
The dialog closes.

At the next startup, the HMI device will use the registry entries and temporary files set.

5.8.8 Changing the print options

The HMI device can print on network printers. You can print hardcopies and reports on a network printer. Line printing of alarms is not possible on a network printer.

The list of current printers and required settings for HMI devices can be found on the Internet at "Printers approved for SIMATIC Panels and Multi Panels (<http://support.automation.siemens.com/WW/view/en/11376409>)".

Requirement

The Control Panel is open.

Procedure



1. Open the "Printer Properties" dialog using the "Printer" icon.

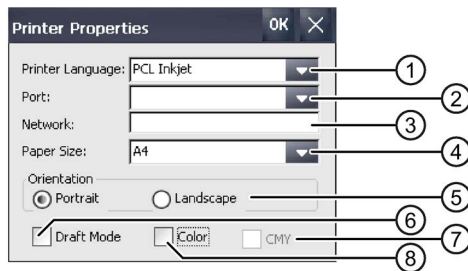

- ① Selection list for the printer
- ② Selection list for the interface
- ③ Network address of the printer
- ④ Drop-down list for printing paper format
- ⑤ "Orientation" group with radio buttons for print orientation
- ⑥ Print quality check box
- ⑦ Check box for color quality, valid only for Brother HL 2700 printer
- ⑧ Color printing check box

2. Select a printer from the "Printer Language" selection list.
3. Select the port for the printer from the "Port" selection list.
4. If you wish to print via the network, enter the printer's network address in the "Network" text box.
5. Select a paper format in the "Paper Size" selection list.
6. Activate a radio button in the "Orientation" group.
 - "Portrait" for printing in Portrait format
 - "Landscape" for printing in Landscape format
7. Select the print quality.
 - Select the "Draft Mode" check box if you wish to print in draft mode.
 - Deactivate the "Draft Mode" check box if you wish to print with higher quality.

8. If the printer selected can print in color and you wish it to do so, select the "Color" check box.
9. If you use a Brother HL 2700 printer, select the "CMY" check box.
This allows you to improve the color quality for the printed pages.
10. Confirm your entries with "OK".
The dialog closes.
The printer is now set as specified.

5.8.9 Displaying general system properties

Use this function to display the general system information relating to the operating system, processor and memory. You will need this information when contacting Technical Support.

Requirement

The Control Panel is open.

Procedure



- Open the "System Properties" dialog using the "System" icon.
The following figure shows an example.

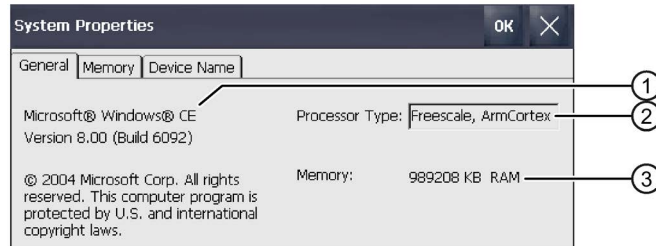

- ① Information on the version and the copyright of the operating system
- ② Processor information
- ③ Information on the size of the RAM

The displayed data relates to the specific device. The processor and memory information may deviate from that for this HMI device.

5.8.10 Displaying information about the Mobile Panel

You can use this function to display device-specific information. You will need this information when contacting Technical Support (<https://support.industry.siemens.com/cs/ww/en/>).

Requirement

The Control Panel is open.

Procedure

1. Open the "OP Properties" dialog using the "OP" icon.
2. Change to the "Device" tab.

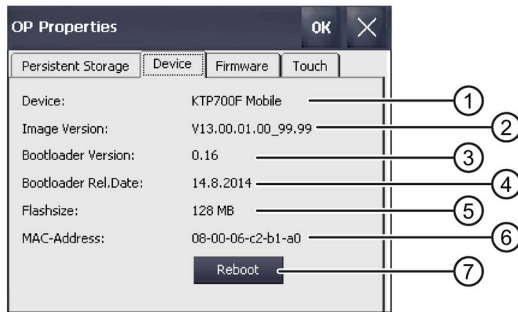

- ① HMI device name
- ② Version of the HMI device image
- ③ Version of the bootloader
- ④ Bootloader release date
- ⑤ Size of the internal flash memory in which the HMI device image and project are stored
- ⑥ MAC address 1 of the HMI device
- ⑦ See "Restarting the HMI device (Page 101)."

Device-specific information is displayed.

Note

The size of the flash memory does not correspond to the available memory for a project.

5.8.11 Display firmware

You can use this function to obtain information about the firmware on the HMI device. You will need this information when contacting Technical Support (Page 268).

Requirement

The Control Panel is open.

Procedure



1. Open the "OP Properties" dialog using the "OP" icon.
2. Change to the "Firmware" tab.

The following firmware versions are displayed.

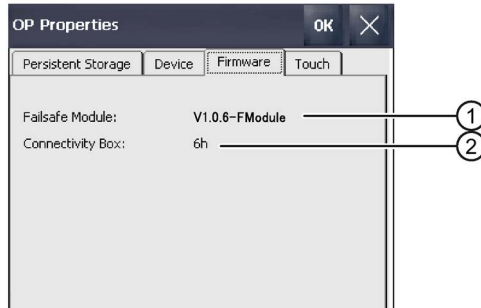

- ① Firmware version of the fail-safe module
- ② Firmware version of the connection box

5.9 Changing Internet settings

5.9.1 Changing general settings

You can use this function to set the homepage and search engine page for an Internet connection over Internet Explorer.

Requirement

- The Control Panel is open.
- Your system administrator has provided the necessary information for the setting.

Procedure



1. Open the "Internet Options" dialog using the "Internet Options" icon.

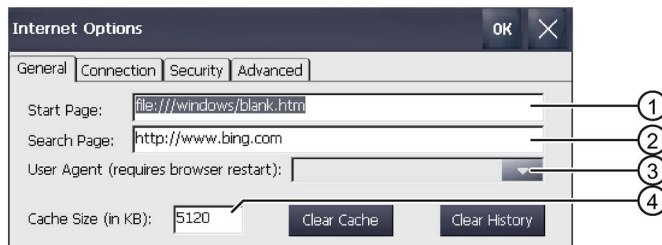

- ① Internet browser homepage
- ② Search engine homepage
- ③ Homepage of your browser
- ④ Memory capacity

2. Enter the homepage for the Internet browser in the "Start Page" text box.
3. Enter the address of the default search engine in the "Search Page" text box.
4. If you want to use your own browser, enter its homepage in the "User Agent" text box.
The browser must then be launched.
5. Enter the required amount of cache in the "Cache" text box.
6. To delete the cache, press "Clear Cache".
7. To delete your browser history, press "Clear History".
8. Confirm your entries.

The dialog closes.

The general parameters for the Internet browser have been set. The settings take effect the next time you start the Internet browser.

5.9.2 Setting the proxy server

Use this function to configure the type of Internet access.

Requirement

- The Control Panel is open.
- Your system administrator has provided the necessary information for the setting.

Procedure



1. Open the "Internet Options" dialog using the "Internet Options" icon.
2. Change to the "Connection" tab.

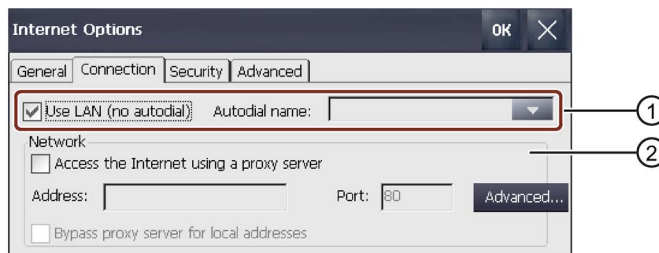

- ① LAN dial-up
- ② LAN configuration

3. If you want to use LAN without automatic dial-up, select the "Use LAN (no autodial)" check box.
4. If you want to use LAN with automatic dial-up, deselect the "Use LAN (no autodial)" check box and select the name in the "Autodial name" list.
5. If you are using a proxy server, select the "Access the Internet using ..." check box in the "Network" group.

6. If you want to use a proxy server, select the "Use a proxy server" check box.

Specify the address and port of the proxy server. Only the start of the addresses is required. Separate the addresses with a semicolon.

7. In order to prevent using the proxy server for certain addresses, press "Advanced".

The following dialog appears:

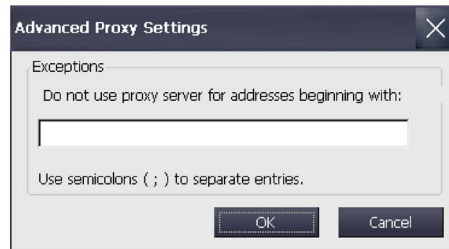

In the text box, enter the addresses for which the proxy server should not be used. Only the start of the addresses is required. Separate the addresses with a semicolon. Confirm your entries with "OK" or close the dialog with "Cancel".

8. To use a local address, select the "Bypass for local address" check box.
9. Confirm your entries.

The dialog closes.

The parameters for the LAN connection have been assigned.

5.9.3 Changing Internet security settings

A cookie typically contains information about websites visited; the Internet browser saves this information automatically when you surf the Internet. You can restrict cookies on a tab under "Internet Options".

Requirement

- The Control Panel is open.
- Your system administrator has provided the necessary information for the setting.

Procedure

1. Open the "Internet Options" dialog using the "Internet Options" icon.
2. Change to the "Security" tab.

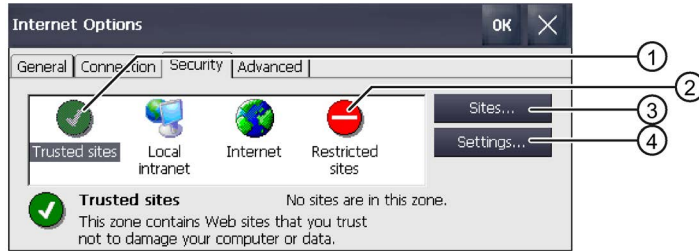

- ① Display trusted websites
 - ② Display restricted websites
 - ③ Allow cookies for the current session only and then automatically delete them
3. Select "Trusted Sites" if you want to view and edit the set trusted websites.
 4. Select "Sites".

The following dialog appears:

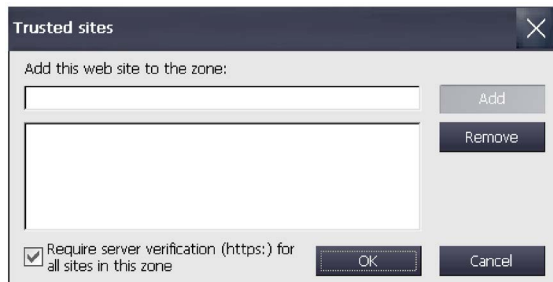

5. To add the website displayed in the "Add this web site ..." field to the list of trusted sites, select "Add".
6. To delete the website displayed in the "Add this web site ..." field from the list of trusted sites, select "Remove".
7. If server verification is required for all websites on the list of trusted sites, select the "Require server verification" check box.
8. To edit the settings for ActiveX control, plug-ins and script languages, select "Settings".

The following dialog appears:

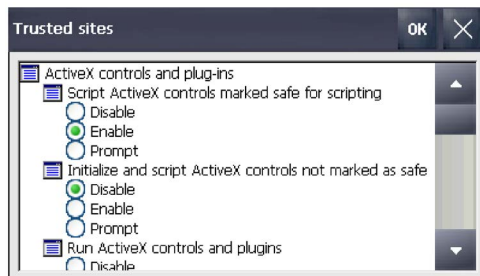

9. Adjust the settings to current requirements.

You can find additional information on the options in this dialog on the Microsoft website.

10. Confirm your entries.

The dialog closes.

The trusted websites are now set.

5.9.4 Activating encryption protocols

Data can be encrypted for greater data transmission security. Common encryption protocols include SSL and TLS. TLS is a more advanced encryption protocol than SSL. You can activate or deactivate the usage of encryption protocols.

Read "General safety instructions (Page 31)".

Requirement

- The Control Panel is open.
- Your system administrator has provided you with the necessary information.

Procedure



1. Open the "Internet Options" dialog using the "Internet Options" icon.
2. Change to the "Advanced" tab.

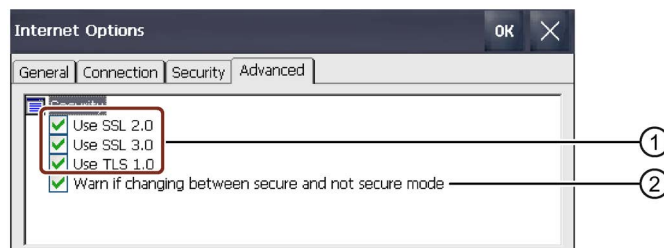

- ① Available encryption protocols
- ② Warning upon switch between secure and non-secure data transmission

3. Activate the required encryption protocols.

Note

If no encryption protocol is activated, data is sent over the Internet in non-secure mode.

4. If you want to be warned that you are switching between secure and non-secure data transmission, select the "Warn if changing between ..." check box.
5. Confirm your entries with "OK".
The dialog closes.

The encryption protocols are set.

5.9.5 Importing, displaying and deleting certificates

You can use this function to import, display and delete certificates. The certificates are proof of an IT qualification and the categories are as follows:

- Certificates that you can trust
- Own certificates
- Certificates from other known providers

A digital certificate consists of structured data, which confirms ownership and other properties of a public key.

Read "General safety instructions (Page 31)".

Requirement

- The Control Panel is open.
- A USB stick with one or more valid certificates is prepared.
- Your system administrator has provided you with the necessary information.

Procedure



1. Open the "Certificates" dialog using the "Certificates" icon.



- ① List of trusted certificates
 - ② Certificate name
2. Insert the USB stick into the USB port.
3. Select the type of certificate from the selection box:
 - "Trusted Authorities" for trustworthy certificates
 - "My Certificates" for your own certificates
 - "Other Certificates" for other certificates

- Use the "Import.." button to specify the source from which the certificate will be imported. The following dialog appears:

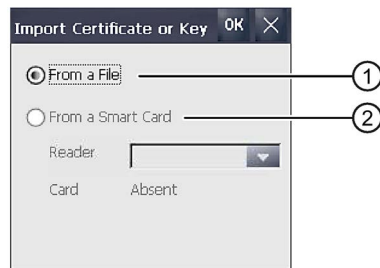

- Import from a file
- Import from a smart card reader

- Select "From a File" or "From a Smart Card" if a smart card reader is connected to the HMI device.

Note

The Smart Card reader is not an approved source for importing certificates for the HMI device.

- Close the dialog with "OK".
- In the subsequent file selection dialog, select the desired certificate on the USB flash drive and confirm with "OK". The certificate will be imported and displayed in the list on the "Stores" tab.
- You can use the "View.." button to display the properties of a certificate.

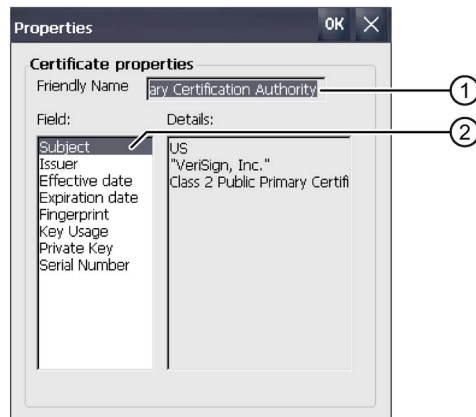

- Name of the selected certificate
- Identity information and other properties of the selected certificate

- You can use the "Remove" button to delete a certificate.

Note

The entry is deleted immediately and without further inquiry. If you want to again use a deleted certificate, you need to import it again from a storage medium.

10. Confirm your entries with "OK".

The dialog closes.

The list of certificates on the HMI device is updated.

5.10 Enabling PROFINET

The HMI device communicates with the PLC over Ethernet. PROFINET must be enabled before you can use the following functions:

- Fail-safe operation with emergency stop/stop button and enabling button over PROFIsafe
- Use of PROFINET direct keys

Requirement

The Control Panel is open.

Procedure



1. Open the "Profinet" dialog using the "PROFINET" icon.

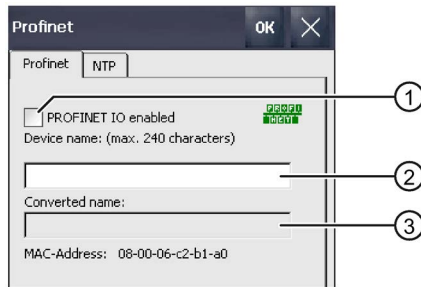

- ① Enables or disables the PROFINET IO direct keys
- ② Text box for the device name
- ③ MAC address of the HMI device

2. Select the "PROFINET IO enabled" check box.

3. Enter the PROFINET device name of the HMI device.

NOTICE
Device name must correspond to HW Config
If the device name does not match the device name entered in the HW Config of STEP 7, the project will start without PROFIsafe connection. Use the device name from the HW Config of STEP 7.

The device name must be unique and satisfy the DNS conventions within the local network. These include:

- Restriction to 127 characters (letters, digits, hyphen or point)
- A name component within the device name, for example, a string between two points, may not exceed 63 characters.
- Special characters such as umlauts, brackets, underscores, slashes, spaces, etc. are not permitted.
- The device name must not start or end with the "-" character.
- The device name must not take the form n.n.n.n (n = 0 to 999).
- The device name must not start with the character string "port-xyz-" (x, y, z = 0 to 9).

4. Confirm your entries.

The dialog closes.

5. Restart the HMI device, see section "Restarting the HMI device (Page 101)".

5.11 Enabling NTP

To obtain the time of the HMI device from a time server, you can specify up to four different time servers. The time is synchronized using the "Network Time Protocol". The synchronization cycle applies to all configured time servers.

Requirement

- The HMI device and time server are located in the same network.
- The Control Panel is open.

Procedure



1. Open the "Profinet" dialog using the "PROFINET" icon.
2. Change to the "NTP" tab.

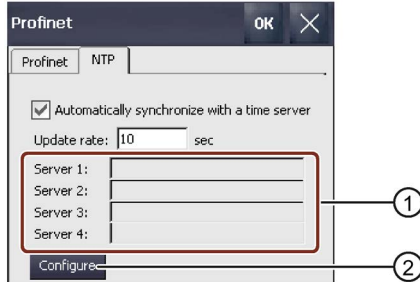

- ① Text box for time servers 1 to 4
- ② Button for configuring the time servers

3. If you want to use the time of a time server, activate "Automatically synchronize with ...".
4. Under "Update rate", enter the time interval in seconds after which the HMI device is to synchronize the time.
Permitted value range: 1 ... 60 000 000 seconds.
5. Press the "Configure" button.
The following dialog is displayed:

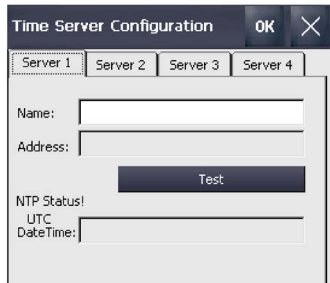

If you do not enter a time, the message "Second field wrong data type." will appear. Enter a time.

6. Enter the DNS name of the time server under "Name".
You can also enter the IP address of the time server.
7. Use the "Test" button to check the accessibility of the time server.
The communication connection to the time server is established and the time is displayed in the "Date Time:" display field. The IP address of the time server is also displayed in the "Address" display.
8. Up to three additional time servers can be set up, if needed.
9. Confirm your entries with "OK".

The communication connection to the time server is now set up and immediately active.

5.12 Setting the PROFIsafe address

The PROFIsafe protocol is used to send safety message frames between the HMI device and the F-CPU. This means each station in the PROFIsafe communication must be assigned a unique PROFIsafe address. When the project is started, the HMI device is automatically logged on to the safety program.

NOTICE

Unique PROFIsafe address required

If more than one device is assigned the same PROFIsafe address, an emergency stop is triggered and the plant switches to the defined safe state.

Assign a PROFIsafe address to the HMI device that is unique within the corresponding local network segment.

Note

PROFIsafe addresses must match

For PROFIsafe communication to work, the PROFIsafe address of the HMI device must match the PROFIsafe address in STEP 7. The PROFIsafe address 65535 is the default address for the HMI device in the delivery state.

Requirement

The Control Panel is open.

Procedure



1. Open the "PROFIsafe" dialog using the "PROFIsafe" icon.

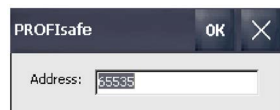

2. Enter a value from 1 to 65534 in the "Address:" text box.
3. Save your entry with "OK".

The PROFIsafe address and access to it are set.

5.13 Configuring network operation

5.13.1 Overview

You can use this function to configure the HMI device for data communication in a PROFINET network via the Ethernet port.

Note

The HMI device has client functionality in the local network. This means that users can access files of a node with TCP/IP server functionality from the HMI device via the local network. However, you cannot access data on the HMI device from a PC via the local network, for example.

A PROFINET network is required for PROFINET IO or PROFIsafe.

Information on communication with SIMATIC S7 over PROFINET is available at:

SIMATIC PROFINET system description
(<https://support.industry.siemens.com/cs/us/en/view/19292127>)

The connection to a local network offers the following options, for example:

- Exporting or importing of recipe data records on or from a server
- Storing alarm and data logs
- Transferring a project
- Printing via the local network
- Backing up data

Addressing computers

Computers are usually addressed using computer names within a PROFINET network. These computer names are translated from a DNS or WINS server to TCP/IP addresses. This is why a DNS or WINS server is needed for addressing via computer names when the HMI device is in a PROFINET network.

The corresponding servers are generally available in PROFINET networks.

Note

The use of TCP/IP addresses to address PCs is not supported by the operating system. Contact your network administrator for more information.

Determine the following parameters:

- Is DHCP used in the local network for dynamic assignment of addresses?
If not, get a TCP/IP address for the HMI device.
- Which TCP/IP address does the default gateway have?
- If a DNS network is used, what is the address of the name server?
- If a WINS network is used, what is the address of the name server?

Configuration includes:

- Specifying the computer name of the HMI device
- Specifying the IP address and name server
- Specifying the logon data
- Configuring e-mail

Parameterization is described from section "Specifying the computer name of the HMI device (Page 131)" on.

5.13.2 Specifying the computer name of the HMI device

You can use this function to assign a computer name to the HMI device. The computer name is used to identify the HMI device in the local network.

Requirement

The Control Panel is open.

NOTICE
Computer name must be unique
Communication errors may occur in the local network if you assign a computer name more than once.
Enter a unique computer name in the ""Device name"" text box.

Procedure



1. Open the "System Properties" dialog using the "System" icon.
2. Change to the "Device Name" tab.

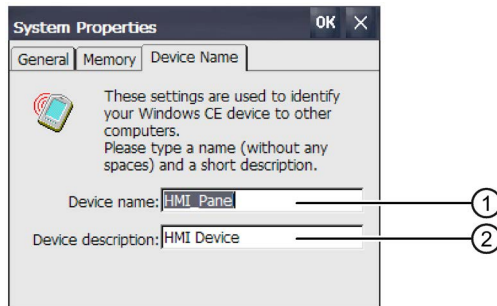

- ① Computer name of the HMI device
 - ② Brief description of the HMI device (optional)
3. Enter the computer name for the HMI device in the "Device name" text box. Enter the name without spaces.

- 4. If necessary, enter a description for the HMI device in the "Device description" text box.
- 5. Confirm your entries with "OK".
The dialog closes.

The computer name for the HMI device is now set.

5.13.3 Specifying the IP address and name server

You can use this function to address the HMI device in the local network.

Requirement



- You have opened the following window with the "Network and Dial-up Connections" icon:



- Your system administrator has provided the necessary information for the setting.

Procedure

- 1. Touch the "PN_X1" icon.

The following dialog appears:

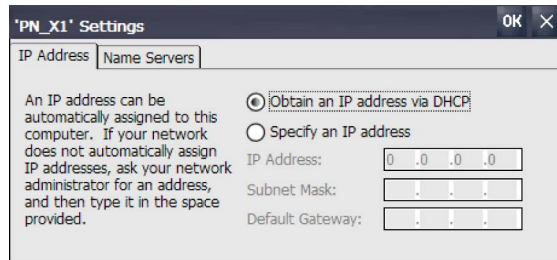

- 2. If you need automatic address assignment, select the "Obtain an IP address ..." option button.
- 3. If you need manual address assignment, select the "Specify an IP address" radio button.

NOTICE
IP address must be unique
An address conflict will occur and there may be malfunctions if more than one device is assigned the same IP address in the local network.
Assign a unique IP address to each HMI device in the local network.

- 4. If you have selected manual address assignment, enter the corresponding addresses in the "IP Address," "Subnet Mask" text boxes and if necessary in "Default Gateway".

5. If a name server is used in the local network, open the "Name Servers" tab.

The following dialog appears:

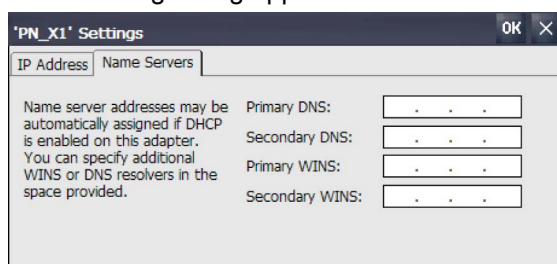

6. Enter the respective addresses in the text boxes.
7. Confirm your entries.

The dialog closes.

8. Close the "Network&Dial-Up Connections" window.

The Control Panel is displayed.

The HMI device is addressed in the local network.

5.13.4 Specifying the logon data

Use this function to enter the information for logging onto local networks.

Requirement

- The Control Panel is open.
- Your system administrator has provided you with the necessary information.

Procedure



1. Open the "Network ID" dialog using the "Network ID" icon.

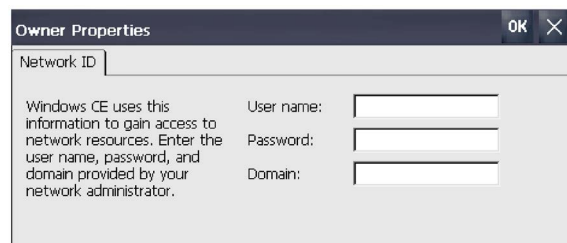

2. Enter your user name in the "User name" text box.
3. Enter your password in the "Password" text box.
4. Enter the name of your assigned domain in the "Domain" text box.
5. Confirm your entries with "OK".

The dialog closes.

The logon data has now been set.

5.13.5 Configuring e-mail

You use this function to set the SMTP server, sender name and e-mail account for e-mail service.

Requirement

- The Control Panel is open.
- Your system administrator has provided you with the necessary information.

Note

Additional tabs may appear in the "WinCC Internet Settings" dialog. This depends on the options that have been enabled for operating the local network in the project.

Procedure



1. Open the "WinCC Internet Settings" dialog using the "WinCC Internet Settings" icon.
2. Change to the "Email" tab.

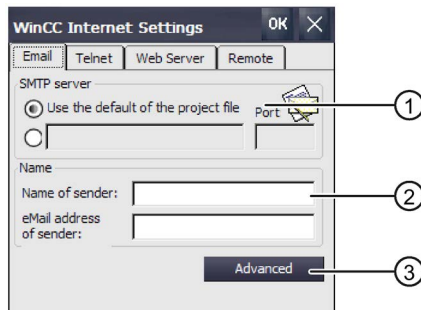

- ① Setting of the SMTP server
- ② Name of the sender and e-mail account
- ③ "Advanced" button for additional settings

3. Specify the SMTP server.
 - Select the "Use the default of ..." option if you want to use the SMTP server configured in the project.
 - Clear the "Use the default of ..." option if you do **not** want to use the SMTP server configured in the project. Enter the required SMTP server and the corresponding port.
4. Enter the name of the sender in the "Name of sender" entry field. The computer name is an appropriate sender name – see section "Specifying the computer name of the HMI device (Page 131)".
5. Enter the e-mail account you use to send your e-mail in the "eMail address of sender" entry field. The "eMail address of sender" entry field can remain empty if your e-mail provider allows e-mails to be sent without checking the e-mail account.

6. If you want to make further settings for sending e-mails over an SMTP server, press the "Advanced" button. The following dialog appears:

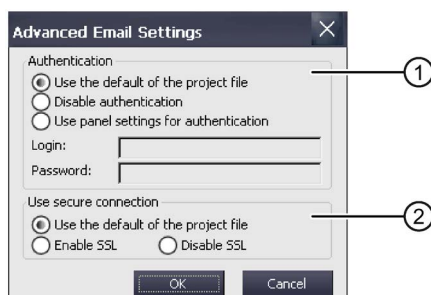

- ① Options for authentication on the SMTP server
- ② Encryption options
7. Specify an option for authentication on the SMTP server.
- Select the "Use the default of ..." option if you want to use authentication data specified in the project.
 - If you use an SMTP server that does not require authentication, select the "Disable authentication" option.
 - Select the "Use panel settings for authentication" option if you want to use the authentication data specified in the settings of the HMI device instead of those in the project. Enter the user name and password.
8. Enter a secure connection.
- Select the "Use the default of the project file" option if you want to use the secure connection of the project.
 - Select the "Enable SSL" option if you want to enable SSL.
 - Select the "Disable SSL" option if you want to disable SSL.
9. Confirm your entries with "OK".
The dialog closes.
10. Close the "WinCC Internet Settings" dialog with "OK".
The e-mail settings have been changed.

5.13.6 Configuring Telnet for remote control

When the Telnet service is activated, you can remotely control the HMI device via Telnet.

 WARNING
Do not activate Telnet service on fail-safe Mobile Panel
Remote access to a fail-safe Mobile Panel via Telnet is not permissible, because undetectable, dangerous functions may be triggered through this access. This can result in personal injury or property damage.
Do not activate Telnet service on a fail-safe Mobile Panel. The default setting is "deactivated".

Requirement

The Control Panel is open.

Procedure



1. Open the "WinCC Internet Settings" dialog using the "WinCC Internet Settings" icon.
2. Change to the "Telnet" tab.

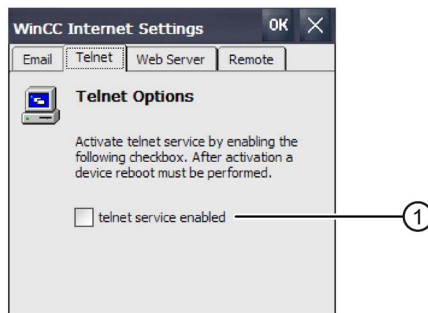

① Check box for activating the Telnet service

3. If you want to use the Telnet service, select the check box.
4. Confirm your entries with "OK".
The dialog closes.
5. Restart the HMI device.

The Telnet service can now be used.

5.13.7 Configure Sm@rt Server

You can use this option to configure the Sm@rtServer for the HMI device. You can then access the HMI device using a Web browser, the Sm@rtClient app or other Java-based clients. Operator control and monitoring of the HMI device is possible, depending on the parameter assignment of the Sm@rtServer.

Sm@rtServer on fail-safe Mobile Panels 2nd Generation

Note the following safety information if you want to operate the Sm@rtServer option in combination with a fail-safe Mobile Panel 2nd Generation.

 WARNING
The plant operator is responsible for security If the Sm@rtServer is activated on an HMI device locally by an operator ("local operator"), an operator outside the system ("external operator") can monitor and operate the HMI device via a Sm@rtServer. Not keeping to the following warnings can result in death or serious injuries. You should also observe the following warnings without fail.

Risk assessment of the plant

 WARNING
Permitted modes must be part of the risk assessment of a fail-safe automation system. If the modes, e.g. "setup mode" and "automatic mode", are not taken into account in the risk assessment, adequate protection against possible dangers is not guaranteed. Death or serious bodily injury can result. For every fail-safe automation system, the permitted modes must be part of the risk assessment. The responsibility for performing the risk assessment lies with the operator of the plant.

 WARNING
The Sm@rtServer function must be taken into account in the risk assessment of a fail-safe automation system. If the use of the Sm@rtServer is not taken into account in the risk assessment, adequate protection against possible dangers is not guaranteed. Death or serious bodily injury can result. For every fail-safe automation system it is necessary to perform a risk assessment taking into account the Sm@rtServer function. This also applies when the Sm@rtServer function is used later in an existing system. The responsibility for performing the risk assessment lies with the operator of the plant.

Danger zone



Obligatory behavior in the danger zone

To avoid injury to persons or damage to property, in the danger zone the local operator may only activate the Sm@rtServer function on an HMI device when the following conditions are met:

- The local operator can see the danger zone.
- The local operator is capable of recognizing personal injury hazards in good time.
- The local operator is capable of taking immediate measures to avoid dangers.
- Nobody must be allowed to remain in the danger zone.

The responsibility for adhering the conditions named lies with the operator of the plant.

Requirement

- For HMI devices with an image that is compatible with WinCC (TIA Portal) prior to V14, the following applies: The HMI device has a Sm@rt Server license that was transferred to the HMI device via the Automation License Manager.
Starting with WinCC (TIA Portal) V14.1, the Sm@rtServer option for Mobile Panels is license-free.
- The HMI device has a project that was compiled with option "Runtime settings > Services > Remote control > Start Sm@rtServer".
- The Control Panel is open.
- Your system administrator has provided you with the necessary information for parameter assignment of the Sm@rtServer.

Note

The "Remote" tab is only available if the HMI device has a project that was created with the "Start Sm@rtServer" option.

Additional tabs may appear in the "WinCC Internet Settings" dialog. This depends on the options that have been enabled for operating the local network in the project.

Procedure



1. Open the "WinCC Internet Settings" dialog using the "WinCC Internet Settings" icon.
2. Change to the "Remote" tab.

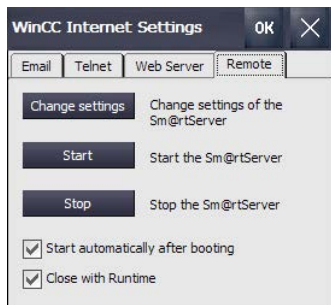

3. Select the options for starting and closing the Sm@rtServer.
 - If the Sm@rtServer is to be started immediately after power-up of the HMI device, select the "Start automatically after booting" option. If this option is disabled, the Sm@rtServer must be started manually using the "Start" button or a corresponding element in the project.
 - Select the "Close with Runtime" option if the Sm@rtServer is to be closed together with the project. If this option is disabled, the Sm@rtServer continues running after the project is closed.
4. Press the "Change Settings" button.

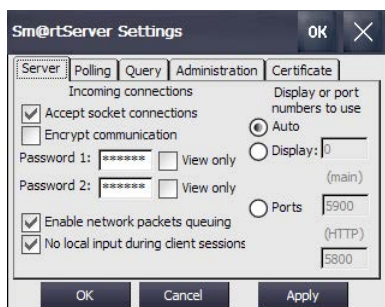

5. Assign two new passwords under "Password 1" and "Password 2". You enter one of the two passwords when accessing the Sm@rtServer.
6. Save the settings using "Apply".
7. Adapt the other settings in the "Server", "Polling", "Query", "Administration" and "Certificate" tabs, if necessary. You can find a description of these settings in the WinCC information system. e.g. by searching for "Sm@rt".
8. Press the "Start" button to start the Sm@rtServer on the HMI device. Use the "Stop" button to close Sm@rtServer.
9. Close the dialog with "OK".

Once the Sm@rtServer has started, you can access the HMI device by specifying the port number and server name/server IP address, e.g. using the Sm@rtClient application or Internet Explorer Version 6 or higher.

Example: The IP address of the device on which the Sm@rtServer was started is "192.168.0.1", and port 5800 is set on the Sm@rtServer.

- Example of call via Internet Explorer: "http://192.168.0.1:5800".
- Example of call via the Sm@rtClient application: "192.168.0.1".

See also

Application examples Mobile Panels 2nd Generation
(<https://support.industry.siemens.com/cs/ww/en/ps/14746/ae>)

5.13.8 Configure Web Server

You can use this option to configure the HMI device as HTTP server. You can then view the HTML pages of the server HMI device using a Web browser or access the tags of the server HMI device using the "SIMATIC HMI HTTP Protocol". Read or write access to the tags is possible, depending on the parameter assignment of the Web Server.

Requirement

- The Web Server is a component of the Sm@rtServer option. For HMI devices with an image that is compatible with WinCC (TIA Portal) prior to V14, the following applies: The HMI device has a Sm@rt Server license that was transferred to the HMI device via the Automation License Manager. Starting with WinCC (TIA Portal) V14, the Sm@rtServer option for Comfort Panels is license-free.
- The HMI device has a project that was compiled with one of the following options in the Runtime settings of the HMI device under "Runtime settings > Services":
 - "HTML pages"
 - "HTTP channel server"
 - "Web Service SOAP"
- The Control Panel is open.
- Your system administrator has provided you with the necessary information for parameter assignment of the Web Server.

Note

The "Web Server" tab is only available if the HMI device has a project that was compiled with one of the three Runtime settings listed under "Requirements".

Additional tabs may appear in the "WinCC Internet Settings" dialog. This depends on the options that have been enabled for operating the local network in the project.

Procedure



1. Open the "WinCC Internet Settings" dialog using the "WinCC Internet Settings" icon.
2. Change to the "Web Server" tab.



3. In the "Tag access" group, define the type of access to the tags of the server HMI device.
 - "Read/write": Read and write access
 - "Read only": Read access
4. In the "Tag authenticate" group, define the authentication required for access to the tags of the server HMI device:
 - "No authentication": No authentication required.
 - "Authentication required": A password is required to access tags. Configure a connection with password protection for access using the SIMATIC HMI HTTP Protocol. In this case, you must select the "Authentication required" option; the associated password on the HMI device must match the password of the configured connection.
5. Select the options for starting and closing the Web Server.
 - If the Web Server is to be started immediately after power-up of the HMI device, select the "Start automatically after booting" option. If this option is disabled, the Web Server must be started manually using the "Start Web-Server" button or a corresponding element in the project.
 - Select the "Close with Runtime" option if the Web Server is to be closed together with the project. If this option is disabled, the Web Server continues running after the project is closed.
6. Press the "User Administration" button.
7. If you are prompted to enter the administrator password, enter the password. The "UserDatabase-Edit" dialog box opens.
8. To create a new user, click "Add" in the "User Manager" tab. Enter a user name and specify a password. The user enters the associated password when accessing the Web Server.
9. Save the settings using "Apply".
10. Change to the "Authorizations" tab.

5.14 Assigning a safety-related operating mode

11. In the "Authorizations" tab you specify the Web authorizations. To use the SIMATIC HTTP server, the user must have the Web authorization "RTCommunication".
12. Save the settings using "Apply" and close the dialog box with "OK".
13. Press the "Start Web-Server" button to start the Web Server on the HMI device. Use the "Close Web-Server" button to close Web Server.
14. Close the dialog with "OK".

When the Web Server is started, you can use a Web browser to access the service pages available on the HMI device by default, additional pages you have configured yourself or other Internet pages. You can access the tags of the server HMI device with a client via a configured HTTP connection.

Additional information on configuration, types of access and certificates is available in the TIA information system under: "Visualize processes > Options > WinCC Sm@rtServer".

5.14 Assigning a safety-related operating mode

This section applies only to fail-safe Mobile Panels and describes how to assign failsafe mode to a connection box.

You make the following specifications for each connection box by selecting the operating mode:

- Function of the emergency stop / stop button: "Emergency stop" or "Stop"
- Type of the F-system: Hardwired F-system or PROFIsafe-based F-system

Read "Important information on emergency stop / stop button (Page 39)".

The table below shows which F-system can be implemented depending on the connection box used and what modes you can use in the corresponding F-system.

Connection box	PROFIsafe-based F-system	Hardwired F-system	
		without emergency stop / stop bypass	with emergency stop / stop bypass
compact	Feasible	Feasible	–
standard	Feasible	Feasible	–
advanced	Feasible	–	Feasible
Possible operating mode	E-stop button evaluated by PROFIsafe	Stop button evaluated by safety relay	Stop button evaluated by safety relay
		E-stop button evaluated by safety relay	E-stop button evaluated by safety relay

Requirement

- The fail-safe Mobile Panel is connected to a connection box.
- The box ID has been set as described in "Setting the box ID of the connection box (Page 70)".

Procedure



1. Open the "Safety operation" dialog using the "Safety Operation" icon.

- ① List of available operating modes:
 - Stop button evaluated by safety relay
 - E-stop button evaluated by safety relay
 - E-stop button evaluated by PROFIsafe
- ② Symbol for the selected operating mode
 - Gray: Stop function
 - Red/yellow: Emergency stop function
- ③ ID of the connection box
- ④ Information on the operating mode selected

If the connection box has not yet been assigned an operating mode, the dialog opens automatically after connecting the Mobile Panel and the following information is in the "Operation Mode" text box: "Operation Mode: Please select!"

2. Select the required operating mode from the drop-down list ①. The color of the icon ② changes according to the operating mode selected.
3. For the "E-stop button evaluated by safety relay" and "E-stop button evaluated by PROFIsafe" operating modes:

Enter the box ID of the connection box in decimal form in the "Verify Box ID" text box. The permitted value range is 1 to 254. The value must correspond to the rotary coding switch setting of the connection box.

The corresponding hexadecimal value is displayed in the "Hex" output field.

4. Confirm your entries with "Save".

Note

For the "E-stop button evaluated by safety relay" and "E-stop button evaluated by PROFIsafe" operating modes:

- If password protection is already enabled, the password prompt is displayed.
- If no password has been assigned, you are prompted to assign a password.

Enter the password and confirm your entry.

You can find additional information on password protection in the section "Entering and deleting a password (Page 105)".

The dialog closes. Information text ④ shows: "Operation mode successfully stored in Connection Box"

5. Close the "Safety operation" dialog with "Close".

The operating mode is assigned.

See also

Using the HMI device in password-protected security mode (Page 89)

5.15 Functions for service and commissioning

5.15.1 Saving to external storage medium – backup

You can use this function to back up the operating system, applications and data from the flash memory of the HMI device to an external storage medium.

Use the following storage media:

- For KTP700, KTP700F, KTP900, KTP900F Mobile: A SIMATIC HMI Memory Card or an industrial USB memory stick
- KTP400F Mobile: An industrial USB memory stick

Requirement

- There is a storage medium with sufficient free capacity in the HMI device.
- Data that must not be overwritten have been saved.

Procedure



1. Open the "Service & Commissioning" dialog using the "Service & Commissioning" icon.

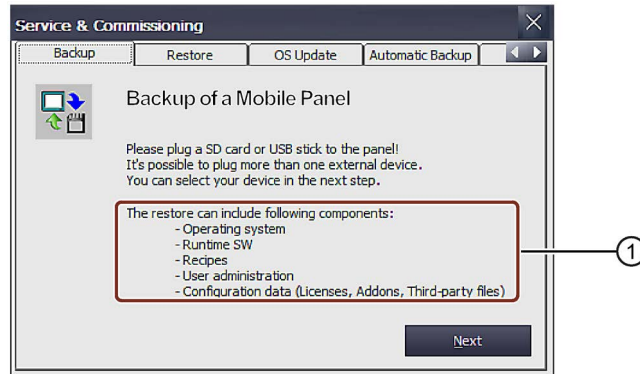

- ① Data that can be saved

2. Press the "Next" button. The following dialog appears:

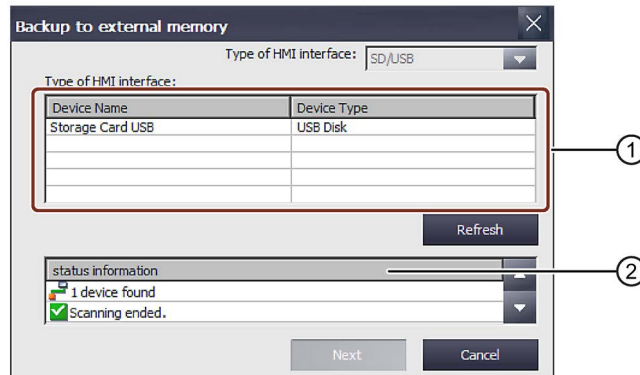

- ① List of available storage media
- ② Status information for the storage medium selected

The "0 devices found" message appears if there is no storage medium in the HMI device or if it is defective. Insert a storage media or replace the storage medium.

3. Press the "Refresh" button.
The "Type of HMI interface" list is updated and the "status information" box contains information about the selected storage medium. Note the memory capacity displayed.
4. Select a storage medium from the "Type of HMI interface" list.

5. Press the "Next" button. The following dialog appears:

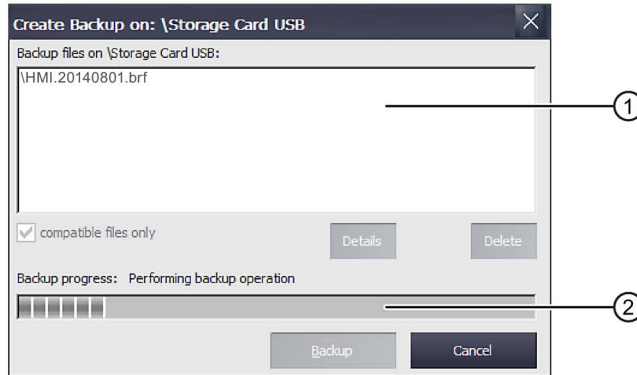

- ① List of available backup files
- ② Progress bar during data backup

6. If you only want to backup compatible files, select the "compatible files only" check box.

- Check box cleared:
The list displays all backup files. This gives the user an overview of the files stored on the storage medium.
- Check box selected:
The list only displays the backups that are compatible with the device currently in use.

7. Press the "Backup" button. The following dialog appears:

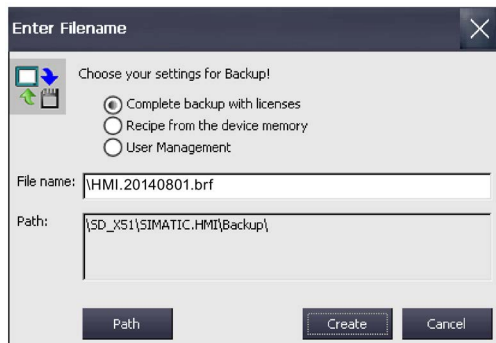

8. Use the option buttons to select the data you want to back up.

9. If required, change the file name in the "File name" field.

10. Press the "Create" button.

The "Create Backup" dialog is displayed. A progress bar shows the status of the data backup. When the backup process is completed, the Backup operation successfully completed. message is displayed.

11. Acknowledge this message. The dialog closes.

12. Close the "Service & Commissioning" dialog.

The HMI device data is now saved on the storage medium.

See also

Storage media (Page 22)

5.15.2 Restoring from external storage medium – Restore

Use this function to restore data from a storage medium to the HMI device.

A restore operation deletes the old data from flash memory of the HMI device on confirmation. The data backed up on the storage medium is then transferred.

Requirement

- The Control Panel is open.
- The storage medium with the backed up data is inserted in the HMI device.

Procedure



1. Open the "Service & Commissioning" dialog with the Service & Commissioning icon.
2. Change to the "Restore" tab.

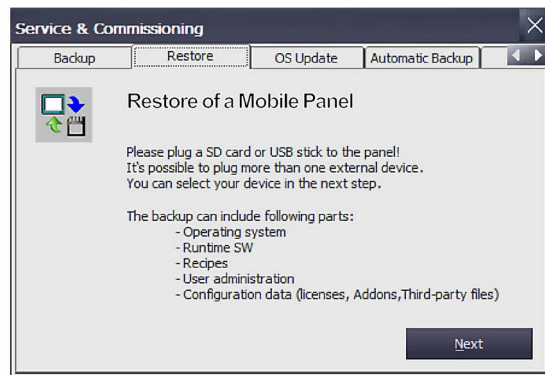

NOTICE

Data loss

All data on the HMI device is deleted during a restore operation. License keys are only deleted after a security prompt.

Back up data before restore operations, if required.

3. Press the "Next" button.

The Restore from external memory dialog is displayed. The dialog corresponds to the "Backup to external memory" dialog in the section "Saving to external storage medium – backup (Page 144)".

The "0 devices found" message appears if there is no storage medium in the HMI device or if it is defective. Insert a storage media or replace the storage medium.
4. Press the "Refresh" button.

The "Type of HMI interface" group is updated. The HMI device checks the storage medium. Information about this storage medium is displayed in the "status information" field.
5. Select the storage medium with the required backup in the "Type of HMI interface" group.

6. Press the "Next" button. The following dialog is displayed.

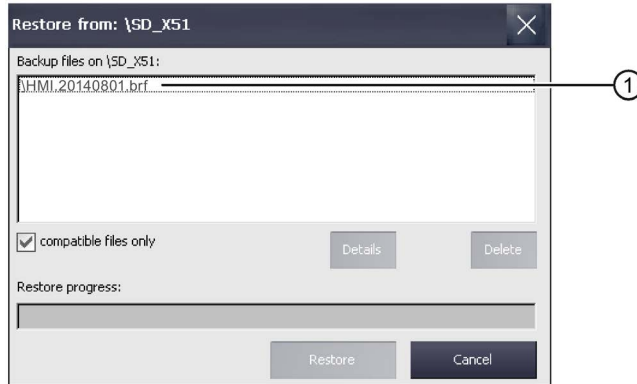

① Backup file

7. Select the required file in the "Backup files on" group.

8. If you need information about the selected file, press the "Details" button. The following dialog appears:

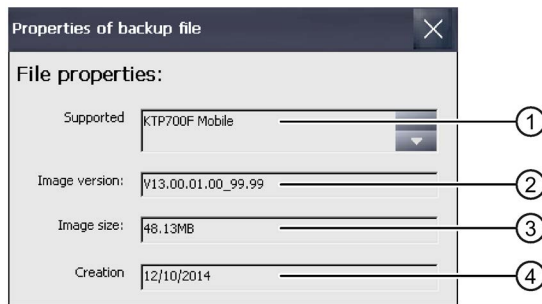

- ① Supported HMI devices
- ② Image of the HMI device
- ③ Size of the selected file
- ④ Creation date of the backup file

9. If you want to delete the selected file, press the "Delete" button. The "Delete confirmation" dialog is displayed.

The file is deleted when you press the "OK" button.

10. To restore the data from the selected file, press the "Restore" button. The following dialog appears:

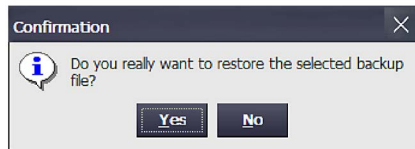

11. Press the "Yes" button to restore the data.

The "Transfer" dialog appears. A progress bar shows the status of the restore process. When the restore operation is complete, the "Restore operation successfully completed." message is displayed. The HMI device then restarts and remains in transfer mode.

12. Remove the storage medium, if necessary.

The data from the storage medium is now restored on the HMI device.

Note

After restoring, a recalibration of the touch screen may be required, see also section "Calibrating the touch screen (Page 100)".

5.15.3 Update operating system

NOTICE

Data loss

All data on the HMI device including the project and HMI device password is deleted during a restore operation. License keys are only deleted after a security prompt.

Back up data before restore operations, if required.

Requirement

- The Control Panel is open.
- A SIMATIC HMI Memory Card or an industrial grade USB flash drive with an HMI device image file including operating system is inserted in the HMI device. The storage medium must have a specified directory structure, otherwise the operating device image file cannot be loaded.
You can find the HMI device image files, for example, in the WinCC installation directory under "\Siemens\Automation\Portal V<TIA version>\Data\Hmi\Transfer\

Procedure



1. Open the "Service & Commissioning" dialog using the "Service & Commissioning" icon.
2. Change to the "OS Update" tab.



3. Press the "Next" button. The "Update OS image from external memory" dialog is displayed.

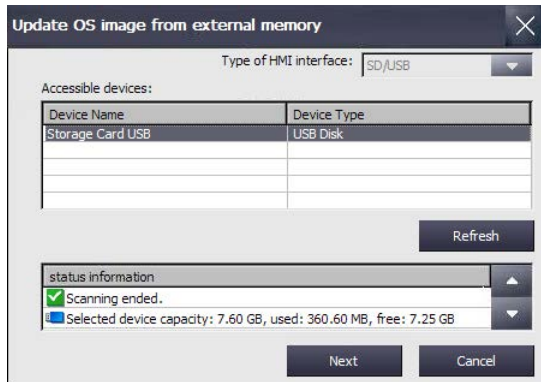

The "0 devices found" message appears if there is no storage medium in the HMI device or if it is defective. Insert a storage media or replace the storage medium.

4. Press the "Refresh" button, if necessary. The "Accessible devices:" group is updated. The HMI device checks the storage medium. Information about this storage medium is displayed in the "status information" field.
5. Select the storage medium with the required HMI device image in the "Accessible devices:" group.
6. Press the "Next" button. The following dialog is displayed.

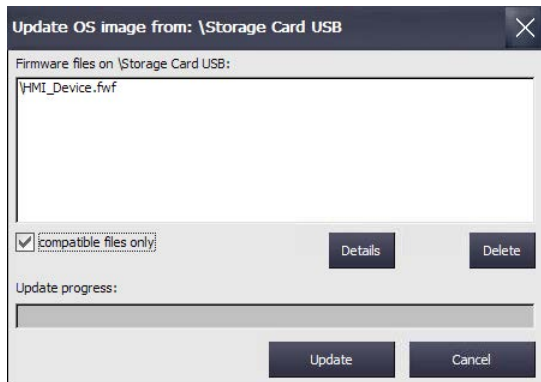

7. Select the required HMI device image file in the "Firmware files on" group.
8. If you need information about the selected file, press the "Details" button. The "Properties of image file" dialog containing the following information is displayed:
 - "Supported": HMI devices that are compatible with the HMI device image
 - "Image version": Version of the HMI device image
 - "Image size": Size of the image file
 - "Creation": Date the image file was created
9. To delete the selected file, press the "Delete" button. The "Delete confirmation" dialog is displayed. The file will be deleted when you press "OK".

10. To restore the data of the selected file, press the "Update" button. The "Update settings" dialog is displayed.

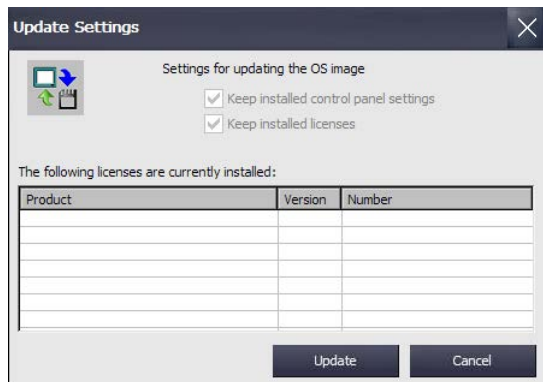

The dialog informs you that the settings in the Control Panel will be kept and offers you the option of keeping or deleting license keys present on the HMI device.

11. Press the "Update" button. The "Update OS Image" dialog is displayed.

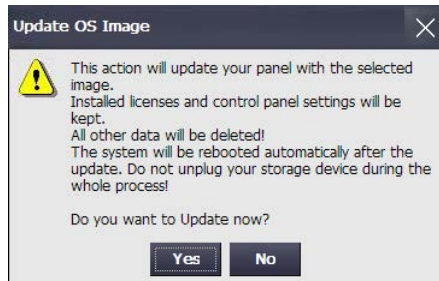

12. Press the "Yes" button to start the restoration of the operating system. The "Transfer" dialog is displayed. A progress bar shows the status of the restore process. The HMI device then restarts.

The operating system is updated on the HMI device.

Note

After restoring, a recalibration of the touch screen may be required, see also section "Calibrating the touch screen (Page 100)".

See also

Restoring from external storage medium – Restore (Page 147)

5.15.4 Load project from external storage medium

This function is available in connection with an HMI device image that is compatible with WinCC (TIA Portal) V14 or higher.

You can use this function to load a project that was backed up to a storage medium in WinCC (TIA Portal) into the HMI device.

You generate the necessary project data in WinCC by configuring the HMI device and then using drag-and-drop to move the folder of the HMI device (e.g. "HMI_1 [<DeviceType>]") to an external storage medium (📁 icon) under "Card Reader/USB memory".

Recommendation: The Runtime and firmware versions of the project should match those of the HMI device.

Requirement

- The Control Panel is open.
- The storage medium with the backed up project is inserted in the HMI device.

Procedure

1. Open the "Service & Commissioning" dialog with the Service & Commissioning icon.
2. Change to the "Load Project" tab.

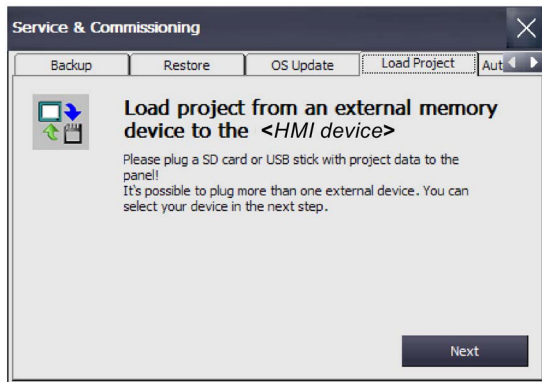

3. Press the "Next" button. The "Load from external memory device" dialog is displayed.

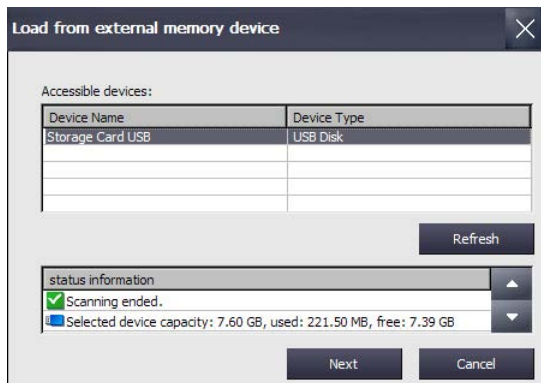

4. Select the storage medium with the project data in the "Accessible devices" group.

- Press the "Next" button. The projects that are located on the external storage medium are displayed in the following dialog. The following figure shows an example.

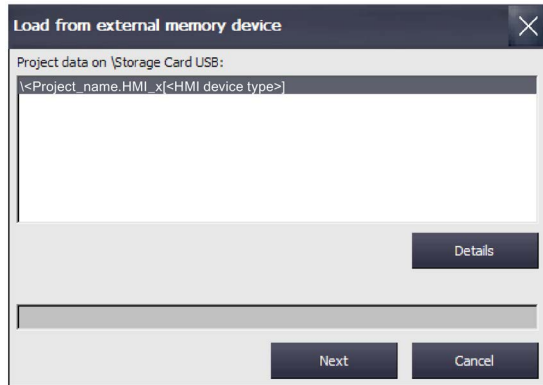

- Select the project that you want to load into the HMI device. Press the "Details" button to receive additional information about the selected project.
- Press the "Next" button. The HMI device checks whether the project data can be loaded. The result of the check is displayed in the "Load Preview" dialog.

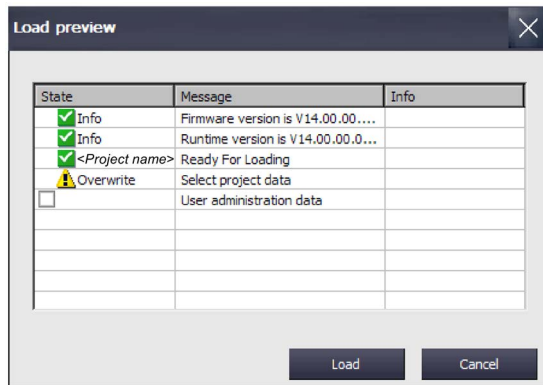

The following messages can be displayed in the "Load Preview" dialog:





- Alarms of type "Information":

Icon	Status	Alarm	Meaning
	Info	Firmware version ... Runtime version ...	Firmware and Runtime version on the HMI device
	Info	Ready For Loading	Project data is suitable for the HMI device





- Alarms of type "Warning" with options:

Icon	Status	Alarm	Meaning
	Overwrite	Select project data	The following lines contain options for overwriting data on the HMI device.
<input type="checkbox"/>		Recipes	Overwrite recipes of the HMI device with the recipes of the project (optional).
<input type="checkbox"/>		User administration data	Overwrite the user administration on the HMI device with the user administration of the project (optional).

5.15 Functions for service and commissioning

Icon	Status	Alarm	Meaning
<input type="checkbox"/> 	Upgrade	Runtime upgrade	Runtime version on the HMI device is older than the Runtime version of the project, versions are compatible, upgrade of Runtime version on the HMI device is optional.
<input type="checkbox"/> 	Upgrade	Firmware upgrade	Firmware version on the HMI device is older than the firmware version of the project, versions are compatible, upgrade of firmware on the HMI device is optional.
<input type="checkbox"/> 	Downgrade	Runtime downgrade	Runtime version on the HMI device is newer than the Runtime version of the project, versions are compatible, downgrade of Runtime version on the HMI device is optional.
<input type="checkbox"/> 	Downgrade	Firmware downgrade	Firmware version on the HMI device is newer than the firmware version of the project, versions are compatible, downgrade of firmware on the HMI device is optional.

– Alarms of type "Error" with option:

Icon	Status	Alarm	Meaning
<input type="checkbox"/> 	Upgrade	Runtime upgrade	Runtime version on the HMI device is older than the Runtime version of the project, versions are incompatible, upgrade of Runtime version on the HMI device is required.
<input type="checkbox"/> 	Upgrade	Firmware upgrade	Firmware version on the HMI device is older than the firmware version of the project, versions are incompatible, upgrade of firmware on the HMI device is required.
<input type="checkbox"/> 	Downgrade	Runtime downgrade	Runtime version on the HMI device is newer than the Runtime version of the project, versions are incompatible, downgrade of Runtime version on the HMI device is required.
<input type="checkbox"/> 	Downgrade	Firmware downgrade	Firmware version on the HMI device is newer than the firmware version of the project, versions are incompatible, downgrade of firmware on the HMI device is optional.
<input type="checkbox"/> 	Download	Runtime download	There is no Runtime software on the HMI device, e.g. after update of the operating system. Runtime software must be downloaded.

<p>NOTICE</p> <p>Data loss</p> <p>If you enable the "Firmware upgrade" or "Firmware downgrade" option, the operating system of the HMI device will be updated. All data on the HMI device, including the HMI device password, is deleted in the process. Settings in the Start Center are retained. License keys are backed up to the external storage medium before the operating system update.</p> <p>Back up your data before the load operation, if necessary.</p>

The project can be loaded into the HMI device if no "Error..."-type alarms occur or if all "Upgrade/Downgrade" options were enabled for the "Error..."-type alarms.

8. Press the "Load" button to transfer the project data with the selected options to the HMI device.

The new project starts on the HMI device after the load operation.

5.15.5 Using automatic backup

The "Automatic backup" function is available on all Mobile Panels 2nd Generation with the exception of the KTP400F Mobile.

When you activate the "Automatic backup" function, the data of the HMI device is automatically backed up to the SD memory card during operation in form of a backup including firmware. Backup is synchronized.

Note

The memory card can be used either as data memory card or system memory card.

When you activate the "Automatic backup" function, the SD memory card of the Mobile Panel is used as **system memory card** and can no longer be used as data memory card.

Use only a SIMATIC HMI Memory Card as the system memory card.

Only the SIMATIC HMI Memory Card ≥ 2 GB may be used as a system memory card. All other memory cards are not recognized as system memory card by the HMI device.

System memory card in a device of a different type

If you use the system memory card of an HMI device in an HMI device of a different type, an error message is displayed.

For service purposes, use a system memory card only in HMI devices of the same type.

Do not remove the system memory card for "automatic backup" during operation

If the "Automatic backup" function is activated, the system memory card may only be removed when the HMI device is switched off.

Automatic backup and updating the operating system

When you want to update the operating system of the HMI device and have activated the "Automatic backup" function, leave the memory card in the HMI device before and after the entire update.

The "Automatic Backup" function is deactivated in the delivery state of the device.

Requirement

- The Control Panel is open.
- A SIMATIC HMI Memory Card Automatic backup to a different SD memory card than the one specified will result in an error message and be canceled.

Enabling and disabling automatic backup

1. Open the "Service & Commissioning" dialog with the Service & Commissioning icon.
2. Change to the "Automatic Backup" tab.

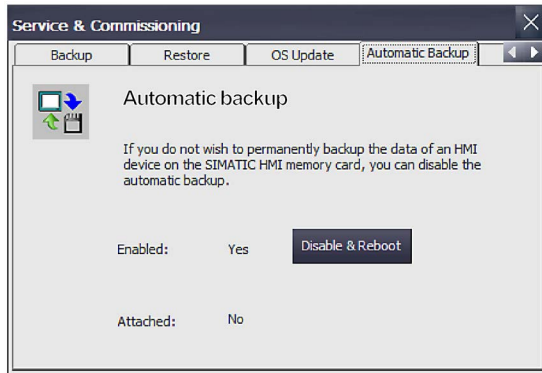

If the "Automatic Backup" function was enabled ("Enabled: Yes"), the "Disable & Reboot" button is displayed.

You can see whether or not a system memory card is inserted under "Attached:".

- "Attached: Yes" means that a system memory card is in the HMI device. The "Safely remove" button is also displayed. Always use the "Safely remove" function to remove the system memory card from the HMI device.
- "Attached: No" means that no system memory card is in the corresponding slot of the HMI device or that the system memory card was not recognized.

If the "Automatic Backup" function is currently disabled ("Enabled: No"), the "Enable & Reboot" button is displayed.

3. Press the "Disable & Reboot" or "Enable & Reboot" button to disable or enable the automatic backup.

The "System card" dialog is displayed.

4. Press the "Yes" button.

Note

There is no message whether a storage medium is inserted / not inserted.

An automatic restart is carried out.

Applications

We differentiate between the following different cases, depending on whether the system memory card was previously used for automatic backup:

Using the system memory card without automatically backed up data

1. In the "Service & Commissioning" dialog, "Automatic Backup" tab, check whether the "Automatic Backup" function is enabled.
 - If the function is enabled, close the dialog.
 - If the function is not enabled, press the "Enable & Reboot" button.
2. Insert the SIMATIC HMI Memory Card without automatic backup into the slot for the memory card.

If the system memory card was recognized and read, the "Use system card" dialog is displayed as follows:

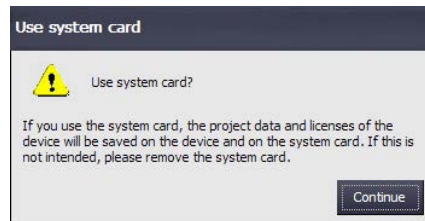

3. Press the "Continue" button. The device copies the data that is required for the "Automatic Backup" function onto the system memory card.

The "Automatic Backup" function is then available.

Using system memory card with automatically backed up data, no project data on the HMI device

1. In the "Service & Commissioning" dialog, "Automatic Backup" tab, check whether the "Automatic Backup" function is enabled.
 - If the function is enabled, close the dialog.
 - If the function is not enabled, press the "Enable & Reboot" button.
2. Insert the SIMATIC HMI Memory Card without automatic backup into the slot for the memory card.

If the system memory card was recognized and read, the "Use system card" dialog is displayed as follows:

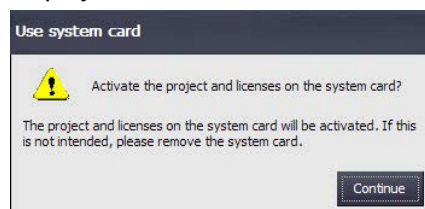

3. Press the "Continue" button.

The data of the system memory card is transferred to the HMI device.

After the data transfer, the state of the HMI device is the same as that of the HMI device used to generate the automatic backup.

Using system memory card with automatic backup, project data on the device

NOTICE
Data loss
All data on the HMI device, including the project and HMI device password, is deleted during a restore operation. License keys are only deleted after a security prompt.
Back up your data before the restore operation, if necessary.

1. In the "Service & Commissioning" dialog, "Automatic Backup" tab, check whether the "Automatic Backup" function is enabled.
 - If the function is enabled, close the dialog.
 - If the function is not enabled, press the "Enable & Reboot" button.
2. Insert the SIMATIC HMI Memory Card with automatic backup into the slot for the memory card.

If the system memory card was recognized and read, the "Use system card" dialog is displayed as follows:

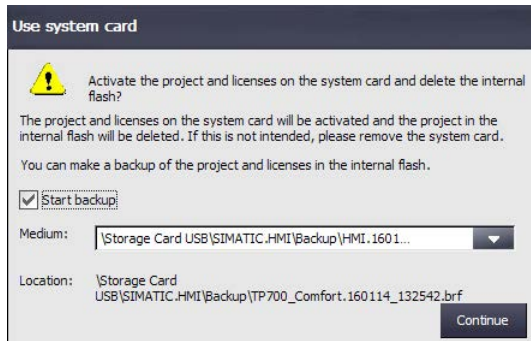

3. Select the "Start backup" check box in order to create a backup of the device data on an external storage medium before the device data is overwritten by the data on the system memory card. Select the corresponding path and file name under "Medium:".
4. Press the "Continue" button. If the "Start backup" check box was selected, the device then creates a corresponding data backup.

The data of the system memory card is then transferred to the HMI device.

After the data transfer, the state of the HMI device is the same as that of the HMI device used to generate the automatic backup.

5.15.6 Editing IP addresses and communication connections

5.15.6.1 Overview

This section describes how you can, from your HMI device, change the IP addresses of controllers and other HMI devices in the subnet of your HMI device and adapt the associated communication connections accordingly. This gives you the ability to create a project, transfer it to multiple HMI devices and then adapt the respective controller connections without changing the project.

If you change the IP addresses of other devices in the subnet of your HMI device, the following steps are required:

- Update IP address and device name; see section "Assigning IP address and device name (Page 160)"
- Update communication connection; see section "Configuring a communication connection (Page 162)".

The following functions are also available:

- A scan function to list the HMI devices and PLC in the subnet.
- Filter function for the scan results
- Check assignment of IP addresses and device names for HMI devices and PLCs.
- Project IP addresses and device names for HMI devices and PLCs can be restored.

5.15.6.2 Assigning IP address and device name

You can use the "Assign IP" function to edit the IP address and device name of target devices in the subnet of your HMI device. The target device can be a controller or another HMI device.

Requirement

- The Control Panel is open.
- For HMI devices, the following applies: The project that runs on the target device is closed.
- For controllers, the following applies:
 - The controller is of type S7-300, S7-400, S7-1200 or S7-1500.
 - HMI access is allowed in the settings.
 - The controller is in "STOP" state.
- Your system administrator has provided you with the necessary information.

Procedure

1. Open the "Service & Commissioning" dialog using the "Service & Commissioning" icon.
2. Change to the "IP Config" tab.

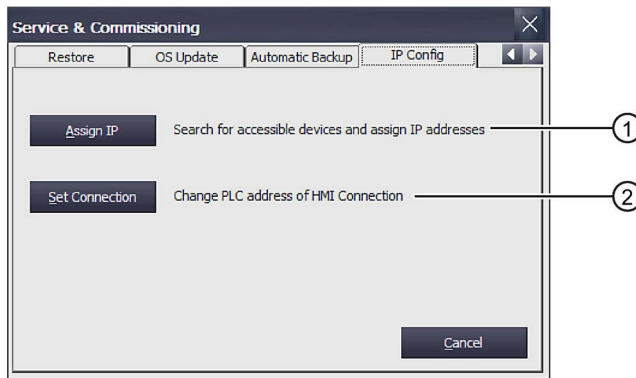

- ① Button for changing IP address and device name
- ② Button for changing the configured communication connections

- Open the "Assign IP" dialog using the "Assign IP" button.

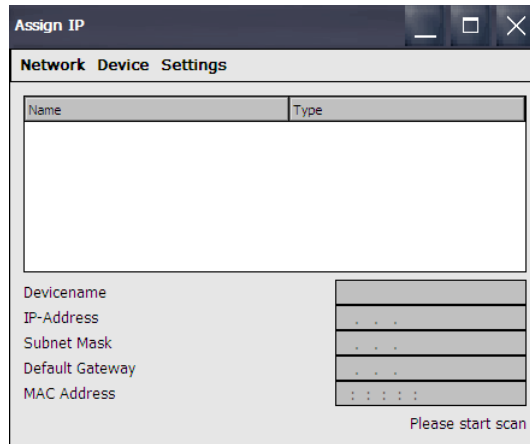

The following functions are available in the menu bar of this dialog:

Menu	Submenu/Entry		Function
Network	Scan	Start	Start search for available devices in the subnet of the HMI device
		Stop	Stop search for available devices in the subnet of the HMI device
	Exit		Close the "Assign IP" dialog
Device	Download	IP	Update IP address of the selected device
		Devicename	Update device name of the selected device
		All	Update IP address and device name of the selected controller
	Flash		Causes the display of the selected HMI device or the "RUN/STOP" LED of the selected controller to flash
	Reset to Factory		Deletes the IP address and device name of the selected device, provided that this function is supported by the selected device and allowed by the security settings.
Settings	Filter	All devices	Find all controllers in the subnet of the HMI device
		MAC Address	Find a controller with a specific MAC address
		Device Type	Find controllers of a certain type
	Interface		Select the interface of the HMI device for the search

- Use "Settings > Interface" to select the interface of the HMI device that is connected to the subnet that is to be searched for other devices, e.g. X1.
- If necessary, select "Settings > Filter" to find a controller with a specific MAC address or controllers of a certain type.
- Select "Network > Scan > Start".
The search for accessible devices located in the subnet of your HMI device is started.
- To stop scanning, press "Network > Scan > Stop".
The scanning is stopped and the devices already found are shown in the list.

8. Select the target device whose IP address and device name you want to change. The following figure shows an example.

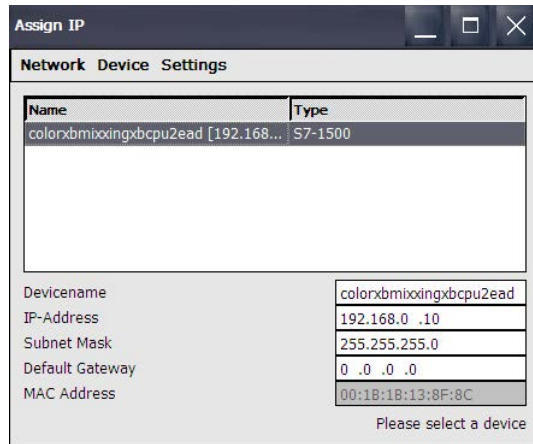

To identify the selected device in the plant, you can use the "Device > Flash" function. The "Flash" function causes the display of the selected HMI device or the "RUN/STOP" LED of a controller to flash.

To reset the IP address and device name of the target device to factory settings, you use the "Device > Reset to Factory" function. This function can only be run if it is supported by the target device and permitted by its security settings.

9. Make the desired changes in the entry fields.
10. Transfer the data to the target device using "Device > Download" and one of the following options.
 - "IP": The IP address on the target device is updated.
 - "Device name": The device name of the target device is updated.
 - "All": The IP address and device name of the target device are updated.

A status message is output at the bottom right indicating whether the update was successful.

5.15.6.3 Configuring a communication connection

If you have changed one or more IP addresses of controllers using the "Assign IP" function, you must then adapt the associated configured connections so that your device can communicate with the controller. You do this using the "Set Connection" function.

Requirement

- The Control Panel is open.
- For HMI devices, the following applies: The project that runs on the target device is closed.

- For controllers, the following applies:
 - The controller is of type S7-1200 or S7-1500.
 - HMI access is allowed in the settings.
 - The controller is in "STOP" state.
- Your system administrator has provided you with the necessary information.

Procedure

The communication connection can only be configured for S7-1200 and S7-1500 controllers.

1. Open the "Service & Commissioning" dialog using the "Service & Commissioning" icon.
2. Change to the "IP Config" tab.

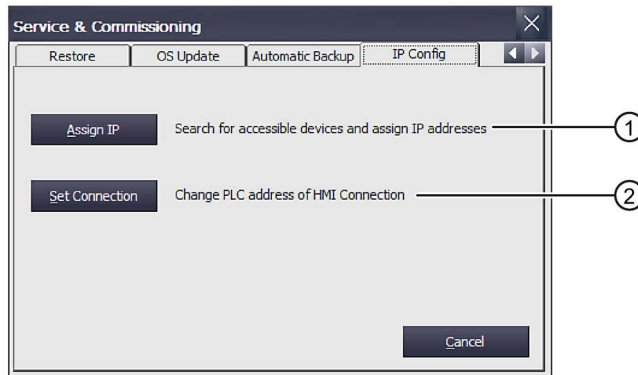

- ① Button for changing IP address and device name
- ② Button for changing the configured communication connections

3. Open the "Set Connection" dialog using the "Set Connection" button.

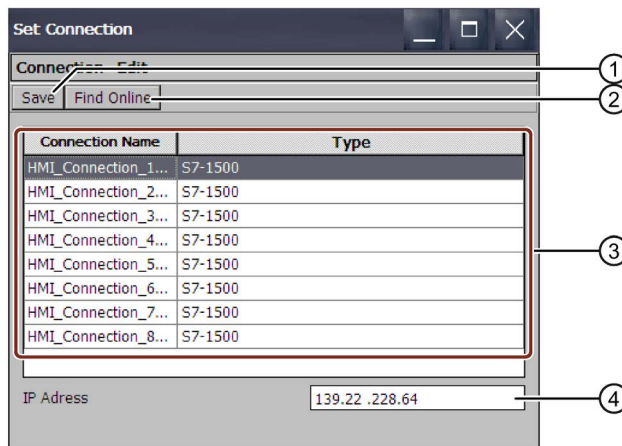

- ① Save setting
- ② Selected communication connection
- ③ List of configured communication connections
- ④ Text box for the IP address

The following functions are available in the menu bar of this dialog:

Menu	Submenu/Entry		Function
Connection	Save		Saves the selected connection parameters
	Exit		Close the "Set Connection" dialog
Edit	Find Online		Find controllers in the subnet of your HMI device
	Restore to Project	Selected PLC	Overwrite IP address of the selected device with the IP address from the project.
		All	Update IP address and device name of the selected controller

4. Press the "Find Controller" button.
 The configured communication connections are listed in the "Connection Name" column. Under "Type", you will find the corresponding S7-1200 or S7-1500 controller. Select the controller to which you want to establish the communication connection.
 The message "No connection available in ProjectSettings.hsf data." is displayed:
 - If no project has been loaded
 - If there is no communication connection to an S7-1200/S7-1500 in the project
5. If the IP address is to be changed, select the relevant communication connection.
 The corresponding IP address is displayed in the "IP address" field.
6. Enter the required IP address in the "IP address" text box.
7. Select "Save".
 The change is saved.
8. Confirm with "OK".
 The dialog closes.
9. Restart the HMI device.
 The communication connection is configured.

Configuring the Mobile Panel

This section contains important information on configuring the Mobile Panels and connection boxes. The following overview shows required and optional configuration steps for the various device types.

Configuration in WinCC		
<ul style="list-style-type: none"> • Adding a controller to the project (Page 167) 	Required for	All Mobile Panels
<ul style="list-style-type: none"> • Adding the Mobile Panel to the project (Page 169) 	Required for	All Mobile Panels
<ul style="list-style-type: none"> • Configuring a fail-safe Mobile Panel (Page 170) 	Required for	Fail-safe Mobile Panels
Configuring fail-safe function blocks		
<ul style="list-style-type: none"> • Configuring F-FBs in STEP 7 (Page 174) 	Required for	Fail-safe Mobile Panels
Configuring plant areas in WinCC		
<ul style="list-style-type: none"> • Configuring connection point detection (Page 179) • Configuring zones and start screens (Page 181) 	Optional for	All connection boxes
Additional configuration options in WinCC		
<ul style="list-style-type: none"> • Configuring function and direct keys (Page 182) • Setting the transfer mode (Page 183) • Changing the operating mode (Page 183) 	Optional for	All Mobile Panels
Controlling and evaluating operator controls and display elements		
<ul style="list-style-type: none"> • Evaluating operator controls as direct keys (Page 184) • Controlling the LEDs of the function keys by means of system functions (Page 187) • Controlling and evaluating the illuminated pushbutton by means of system functions (Page 187) 	Optional for	All Mobile Panels
<ul style="list-style-type: none"> • Evaluating the key-operated switch by means of system functions (Page 188) 	Optional for	Fail-safe Mobile Panels

Fail-safe Mobile Panels

NOTICE
<p>Avoiding PLC STOP</p> <p>The replugging a fail-safe HMI device without logoff can lead to a communication error message. To avoid a PLC STOP in such cases, use the required organization blocks. You can find additional information in the following FAQ: Which organization blocks can be used in STEP 7 (TIA Portal)? https://support.industry.siemens.com/cs/ww/en/view/40654862</p>

Note

Observe the configuration sequence

Configure the communication connection between the Mobile Panel and controller before creating the safety program.

You must implement the following function blocks in your safety program:

- An FB198 for each Mobile Panel: F_FB_KTP_Mobile
- An FB199 for each connection box: F_FB_KTP_RNG
- FB215: ESTOP1; use this block to ensure that the operator must provide acknowledgment after an emergency stop before restarting the plant. You can find this block in the following block container of the "Safety Advanced" F-library: "Communication > Fail-safe HMI Mobile Panels > -- KTP Mobile --"

Topology for connection box standard and connection box advanced

NOTICE
Parameterizing the internal switch
If you are using an HMI device image from the scope of delivery of the WinCC (TIA Portal) V13 SP1 Update 4 software on your HMI device, the following applies: Parameterization of the internal switch of the connection box is necessary when one or more connection boxes are used in a line topology. The internal switch is parameterized via the Web server interface. During parameterization of the internal switch, disable the option "Passive Listening" to ensure interruption-free communication; see the following figure.

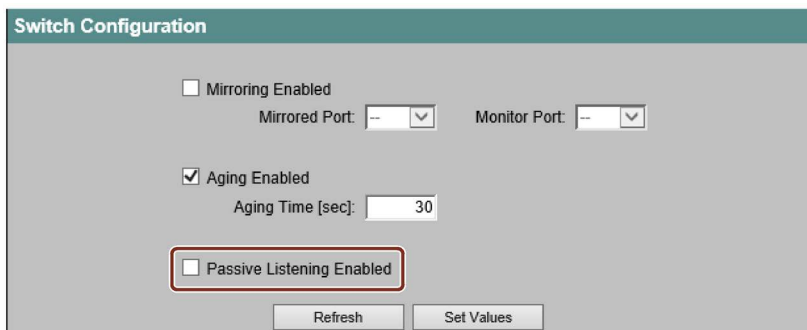

You can find additional information on configuration in the information system of the TIA Portal.

See also

"SIMATIC Safety - Configuring and Programming" programming and operating manual (<http://support.automation.siemens.com/WW/view/en/54110126>)

Application example (<https://support.industry.siemens.com/cs/ww/en/view/103497649>)

6.1 Configuration in WinCC

6.1.1 Adding a controller to the project

Requirement

- A project is open.

Procedure

1. Double-click "Add new device" in the project tree.

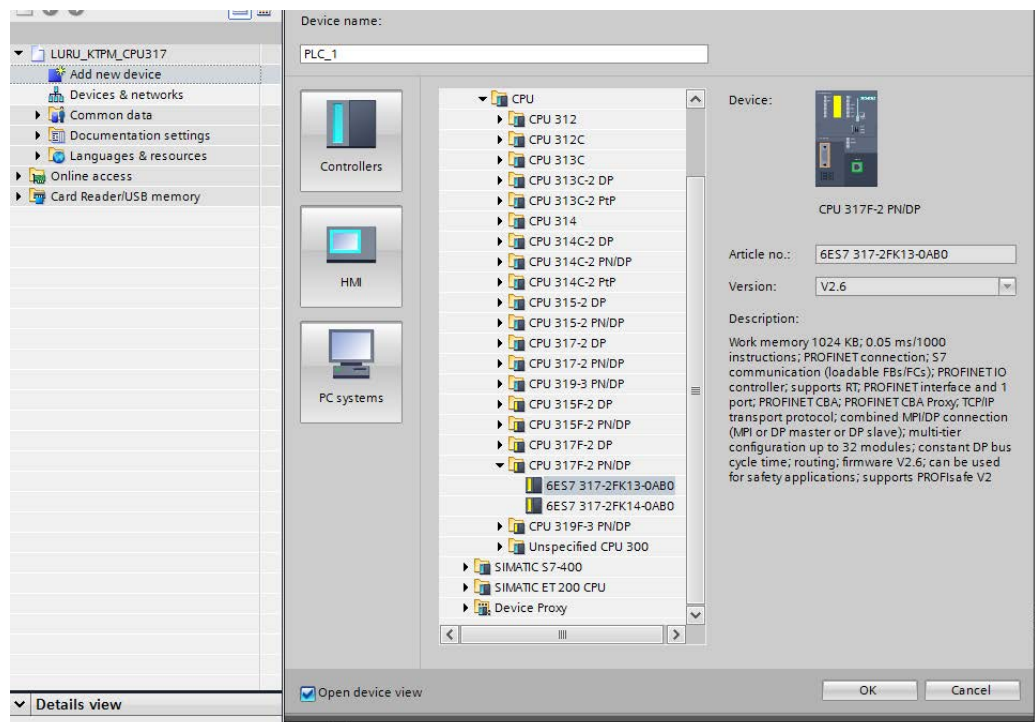

2. Select a controller (CPU) or a fail-safe controller (F-CPU) for an F-system.

3. Click the icon of the controller.

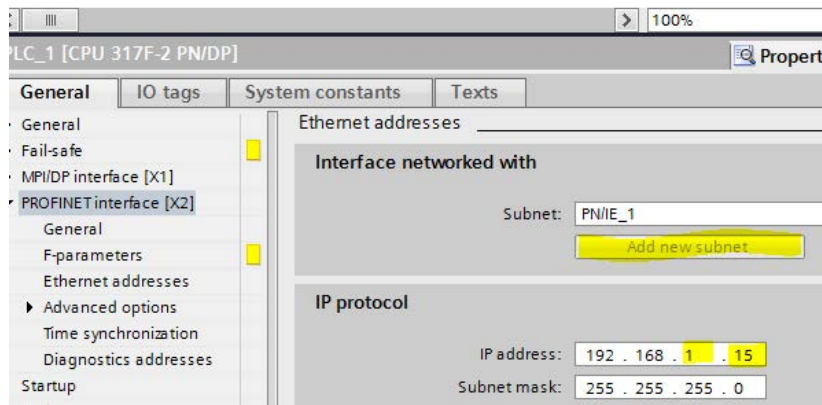
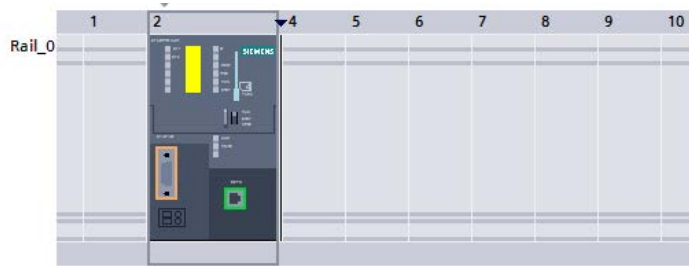

4. Select "PROFINET interface [X2]" in the properties window.
5. Under "Ethernet addresses", click on the "Add new subnet" button.
6. Under "IP protocol", assign a unique IP address to the controller in the subnet.

6.1.2 Adding the Mobile Panel to the project

Requirement

- A project is open.
- A controller has been added to the project.
- Subnet and IP address of the controller are configured.

Procedure

1. Double-click "Add new device" in the project tree.

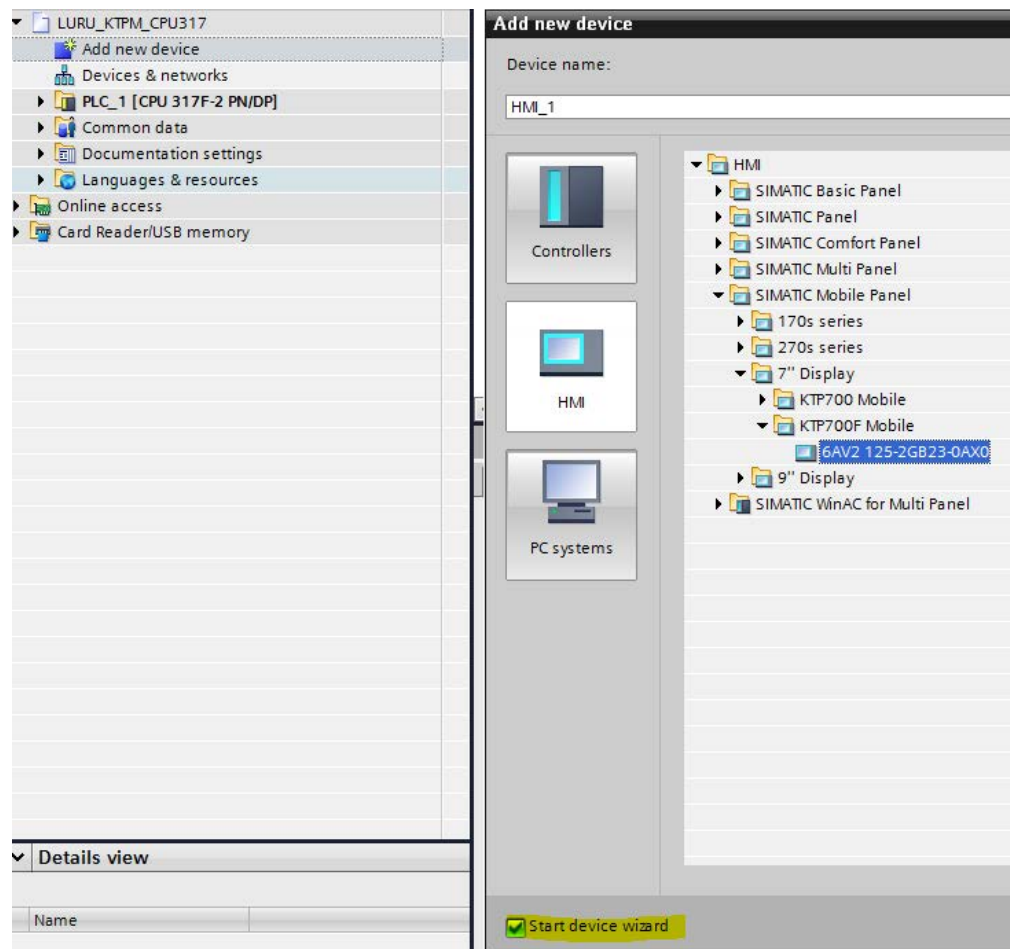

2. In the "Add new device" dialog, click "HMI".

3. Select an HMI device of the type KTP Mobile or KTP F Mobile for an F-system and select the "Start Device Wizard" checkbox.

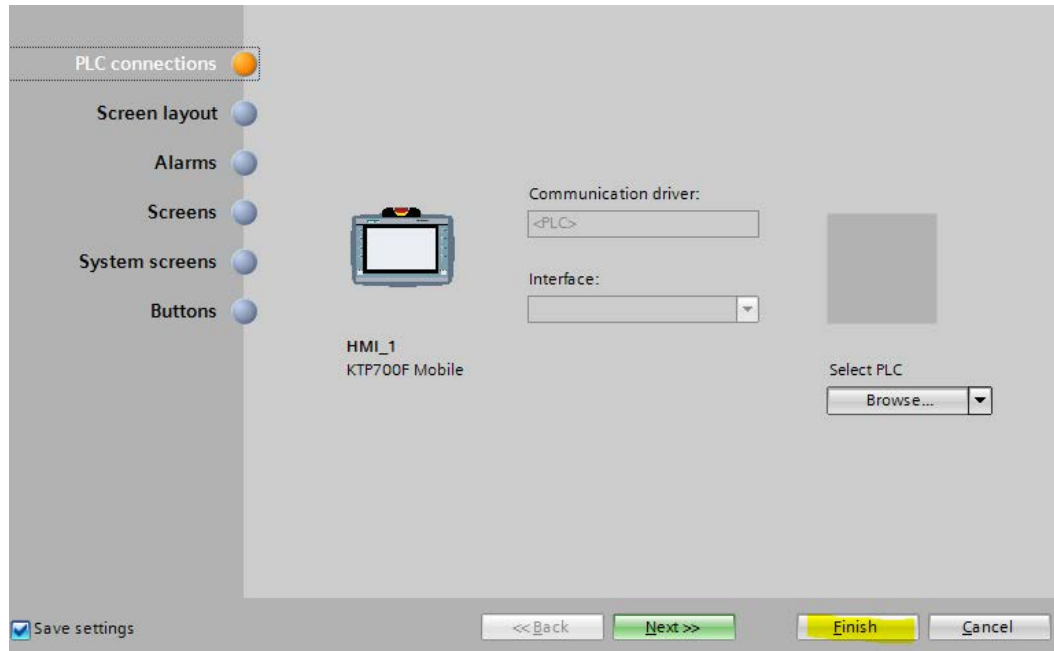

4. Select "Finish".
The Mobile Panel is added to the project.

6.1.3 Configuring a fail-safe Mobile Panel

The emergency stop or stop can be evaluated either by a hardwired F-system or by a PROFIsafe-based F-system.

- For a hardwired F-system:
The fail-safe Mobile Panel must be configured like a **non-fail-safe** Mobile Panel. The "PROFIsafe" option must not be activated.
- PROFIsafe-based F-system:
The "PROFIsafe" option must be enabled for the fail-safe Mobile Panel.

The following procedure is for configuring a fail-safe Mobile Panel.

Requirement

- An F-CPU has been added to the project.
- The PROFINsafe address of the F-CPU is configured.

Procedure

1. Double-click on "Device configuration".

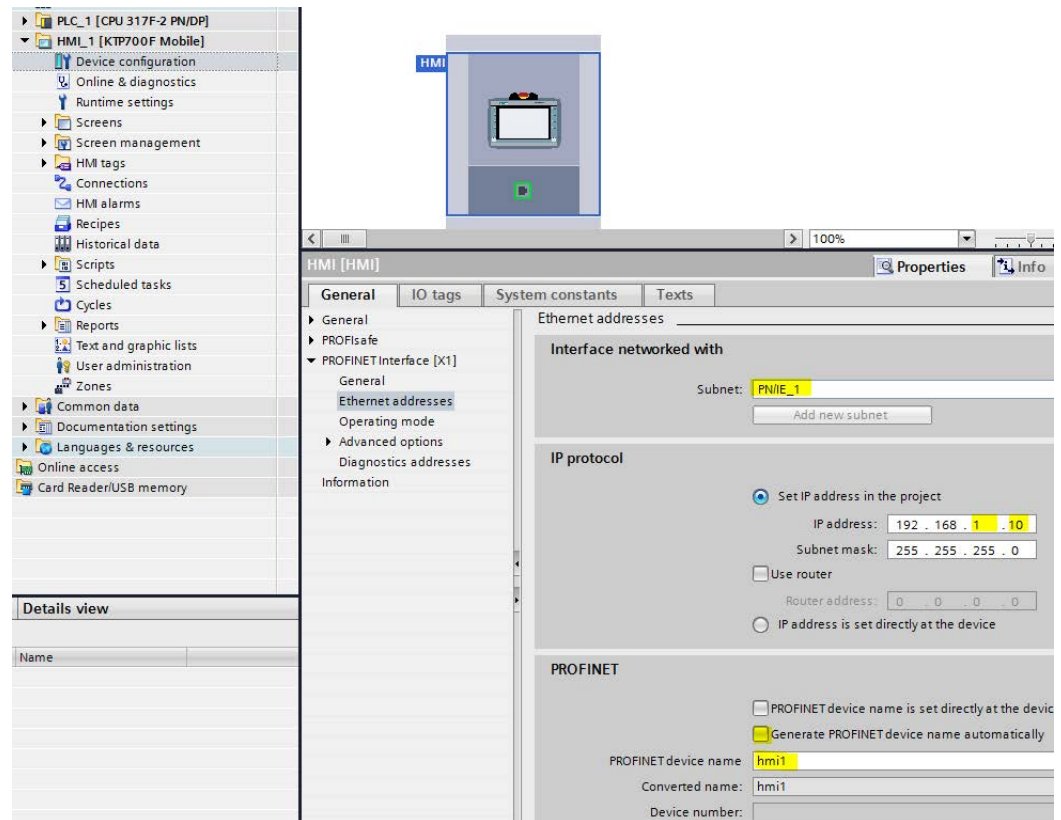

2. Click on the icon of the HMI device.
3. Select "PROFINET interface [X1] > Ethernet addresses" and enter the following parameters:
 - "Interface networked with": Subnet that is used by the fail-safe controller, in the example "PN/IE_1"
 - "IP protocol": Specify a unique address in the subnet for the HMI device. This address must match the address that is set in the Control Panel of the HMI device, see section "Specifying the IP address and name server (Page 132)".
 - "PROFINET": Enter a device name. This device name must match the name defined in the Control Panel of the HMI device, see section "Enabling PROFINET (Page 126)".

4. Select "PROFINET interface [X1] > Operating mode".

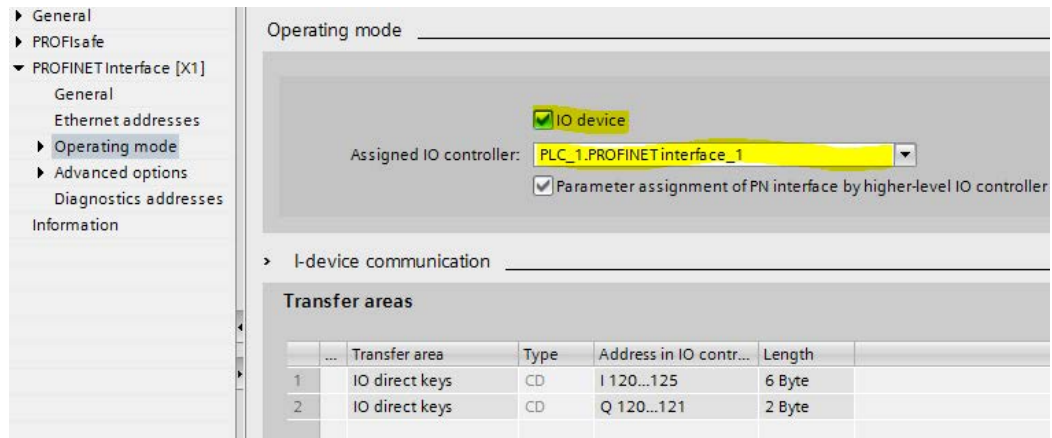

- Select the "I/O device" check box.
- Select the controller as IO controller.

5. Select "PROFIsafe > Activate PROFIsafe".

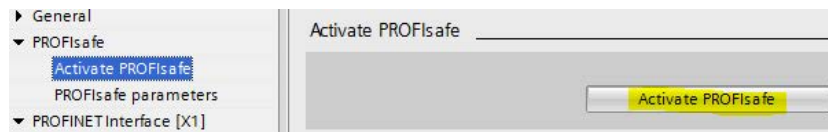

Press "Activate PROFIsafe".

Note

After the button is pressed, an F-data block containing the device name of the Mobile Panel (in the example: "Fxxxxx_Hmi_1") is created automatically. This F-data block contains the required block parameters and is interconnected with the corresponding "F_FB_KTP_Mobile" block in the next section.

6. Select "PROFIsafe > PROFIsafe parameters".

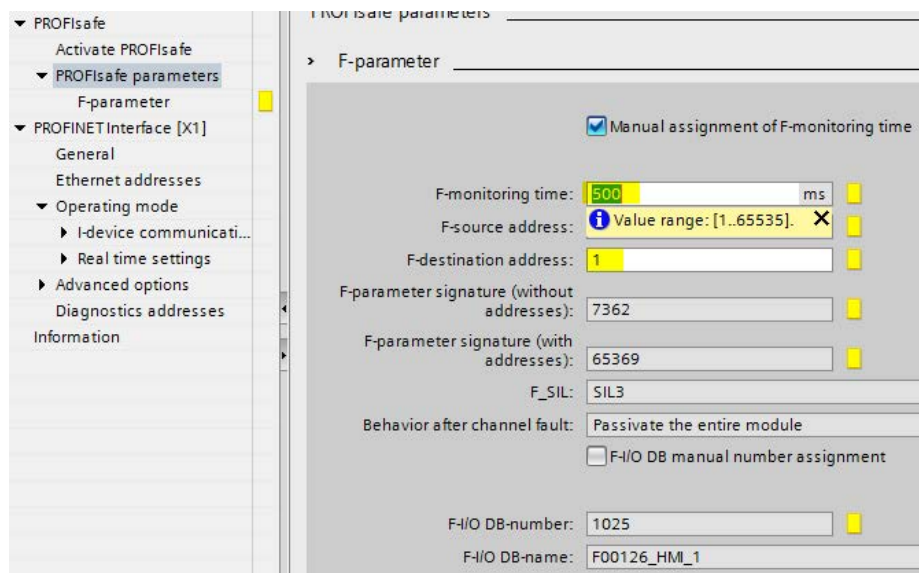

7. Select the "Manual assignment of F-monitoring time" check box and enter the following values at the indicated locations.
 - "F-monitoring time": Enter the monitoring time for the PROFIsafe driver. The default value is 500 ms. This value can be optimized depending on the number of devices to be monitored.
 - "F-destination address": This value must match the PROFIsafe address of the HMI device, see section "Setting the PROFIsafe address (Page 129)". The value must be unique within the PROFINET network.
8. Select "PROFINET interface [X1] > Operating mode > I-device communication".

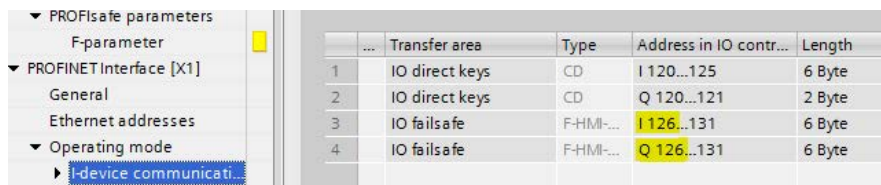

...	Transfer area	Type	Address in IO contr...	Length
1	IO direct keys	CD	I 120...125	6 Byte
2	IO direct keys	CD	Q 120...121	2 Byte
3	IO failsafe	F-HMI...	I 126...131	6 Byte
4	IO failsafe	F-HMI...	Q 126...131	6 Byte

This area now shows the input and output addresses, which are to be used later when configuring the F-FBs for the fail-safe HMI device.

9. Configure the PROFIsafe connection as follows:
 - Double-click "Devices and Networks" and select the graphical connection between the HMI device and controller, in the example "PN/IE_1".
 - Click on "Connections" and select "Edit connections" in the shortcut menu of the HMI device.
 - Select the controller and confirm by pressing the "Add" button.

The graphical connection is highlighted in the editor.

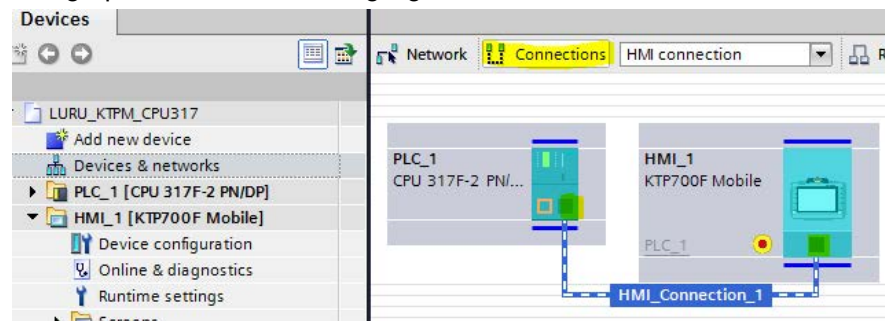

10. Configure a message window.

! WARNING

Safety-related messages not visible without message window

If no message window is configured, safety-related messages cannot be displayed, which may result in personal injury or material damage.

Configure a message window for display of messages of the "Safety warnings" message class. You can find a description in the online help for WinCC (TIA Portal).

11. Compile the project by right-clicking on the HMI device using "Compile > Software (rebuild all)".

6.2 Configuring F-FBs in STEP 7

This section applies only to fail-safe Mobile Panels in a PROFIsafe-based F-system. This section describes the configuration using an example of an S7-300F-type controller. Other compatible fail-safe controllers are configured in the same way.

Requirement

- Fail-safe mode has been configured as described in the section "Configuring a fail-safe Mobile Panel (Page 170)".
- The PROFIsafe address has been set as described in the section "Setting the PROFIsafe address (Page 129)".

Procedure

1. Under the fail-safe controller in the device view, select "Safety Administration > F-runtime group 1 [RTG1]".

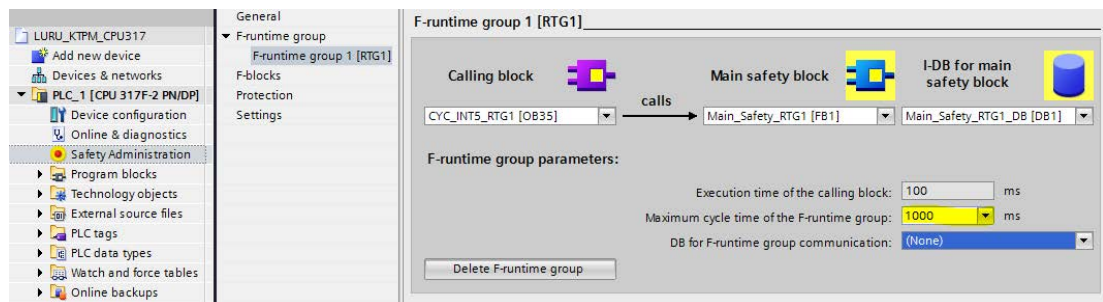

2. Set the maximum cycle time at the point indicated. A higher cycle time can improve the stability of the PROFIsafe communication. The F-FBs for the Mobile Panel are placed in the "Main safety block" FB in the following steps. A data block for group communication can be optionally selected under "I-DB for main safety block".
3. Double-click on "Program blocks > Main_Safety_RTG_1 [FB1]" under the fail-safe controller.
4. Select "Communication > Failsafe HMI Mobile Panels > -- KTP_Mobile --" to the right in the instruction window.

5. Insert F_FB_KTP_Mobile in Network 1.

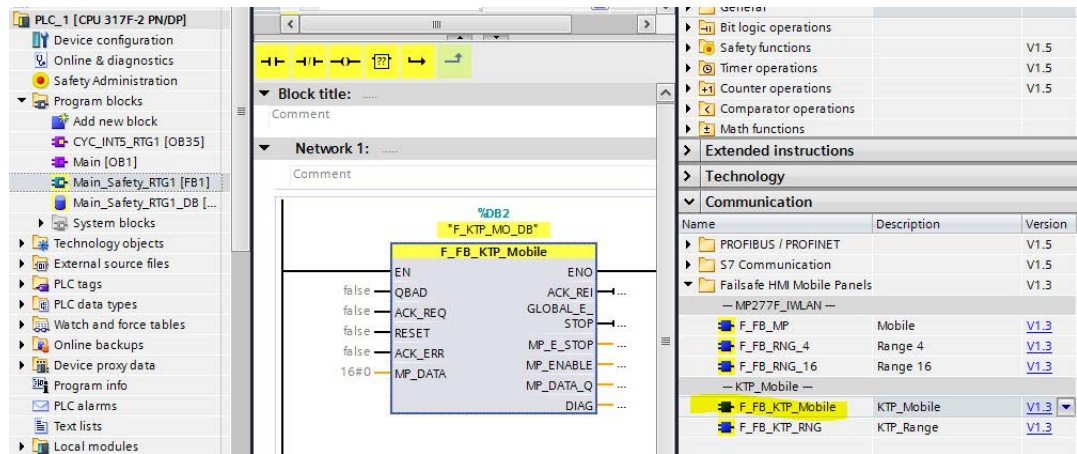

The name of the instance DB, which includes the number of F-input address, is displayed above F_FB_KTP_Mobile.

Note

A F_FB_KTP_Mobile is required for each fail-safe Mobile Panel.

The signals of the HMI device are wired to the F_FB_KTP_Mobile in the following step.

6. Click in the "false" value of the QBAD input. Select the "F00126_HMI_1.QBAD" signal of the HMI device using the selection button next to the text box.

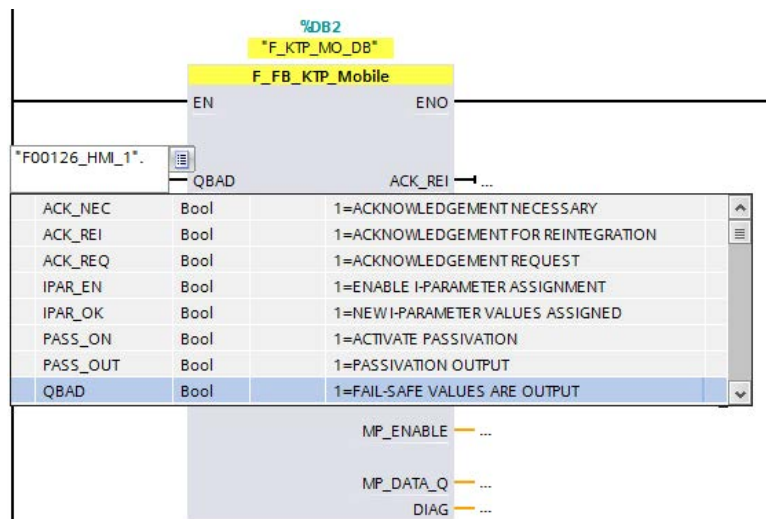

Interconnect the following inputs and outputs in similar fashion:

- ACK_REQ and the ACK_REI output to the acknowledgment signals of the HMI device with the same name.

- Interconnect the MP_DATA input with the F-input address and the MP_DATA_Q output with the F-output address of the HMI device. You can find the corresponding addresses in the device configuration of the HMI device under "PROFINET interface [X1] > Operating mode > I-device communication". Click on the "false" text next to the corresponding input or output and, for our example, use the keyboard to enter:
 - MP_DATA: "IW126"
 - MP_DATA_Q: "QW126"

The user data are transferred via the MP_DATA input and the MP_DATA_Q output.

Note

If you are using the F_FB_KTP_Mobile with F_FB version <2.0 in combination with a controller of the type S7-1500F, you must change the data type of the automatically generated PLC tags at input MP_DATA and output MP_DATA_Q from "Word" to "Int" in the PLC tag table. The default names "Tag_1" and "Tag_2" were used for the PLC tags in this example.

This interconnects the F_FB_KTP_Mobile with the HMI device. To operate the HMI device with the emergency stop and enabling functions on one or more connection boxes, for each connection box you need an F_FB_KTP_RNG that is connected to the F_FB_KTP_Mobile.

Note

If you do not need the "Enabling" function and only want to configure a global emergency stop, you do not need an F_FB_KTP_RNG. In this case, use the "GLOBAL_E_STOP" output of the F_FB_KTP_Mobile in your safety program.

If you are configuring multiple connection boxes with and without F_FB_KTP_RNG in mixed operation, you must evaluate output "GLOBAL_E_STOP" of F_FB_KTP_Mobile and output "E_STOP" of all utilized F_FB_KTP_RNG blocks.

The following procedure describes:

- Creation of an F-data block for caching the input signals for the enabling button and emergency stop / stop button. Caching is needed if you want to operate an HMI device with multiple connection boxes.
-

Note

Alternatively, you can use the static data area of the block that calls the F_FB_KTP_Mobile and F_FB_KTP_RNG blocks in the safety program. The calling block can be the "MAIN safety block" or any other user block, see also the figure for step 1.

- Configuration of the connection between F_FB_KTP_Mobile and F_FB_KTP_RNG via the F-data block.

7. Double-click "Program blocks > Add new block" under the fail-safe controller.

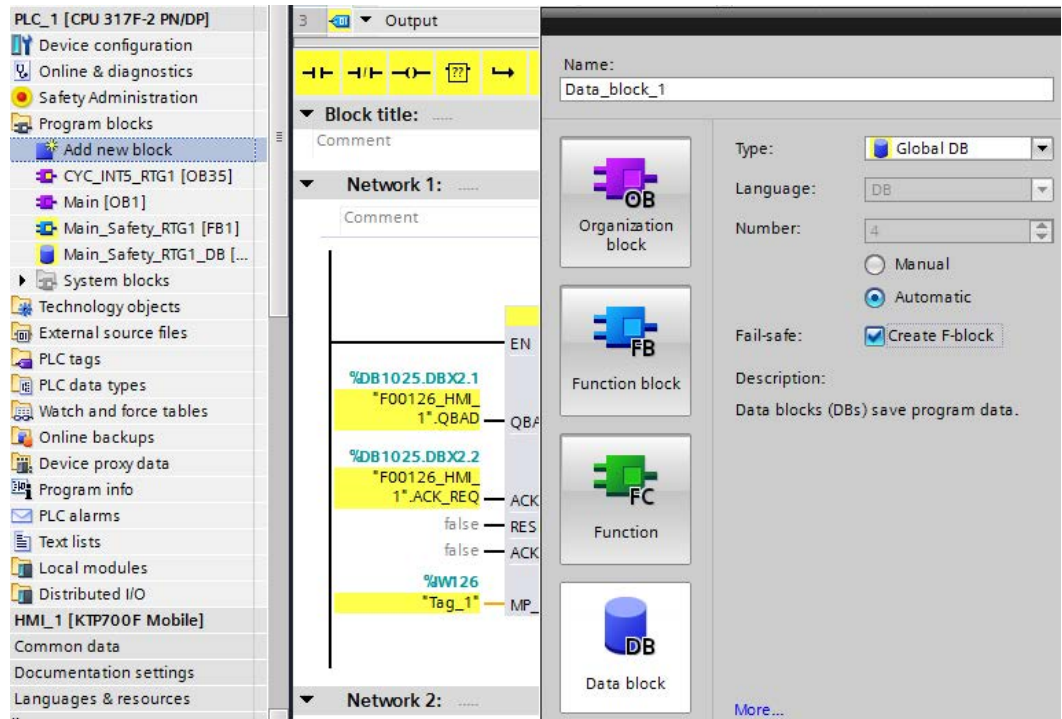

8. Select the "DB data block" icon, select the "Create F-block" check box, assign a name ("Data_block_1" in the example) and confirm with "OK".
9. Create the two tags "E_STOP" and "ENABLE" of the "Word" data type within the F-data block.

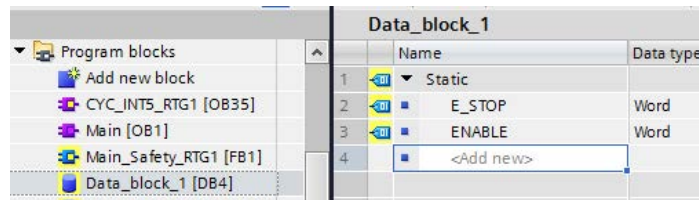

10. Select "Communication > Failsafe HMI Mobile Panels > -- KTP_Mobile --" to the right in the instruction window.
11. Insert F_FB_KTP_RNG in Network 2.

12. Interconnect the MP_E_STOP and MP_ENABLE outputs of the F_FB_KTP_Mobile via the F-data block ("Data_block_1" in the example) to the F_FB_KTP_RNG, as shown in the figure below.

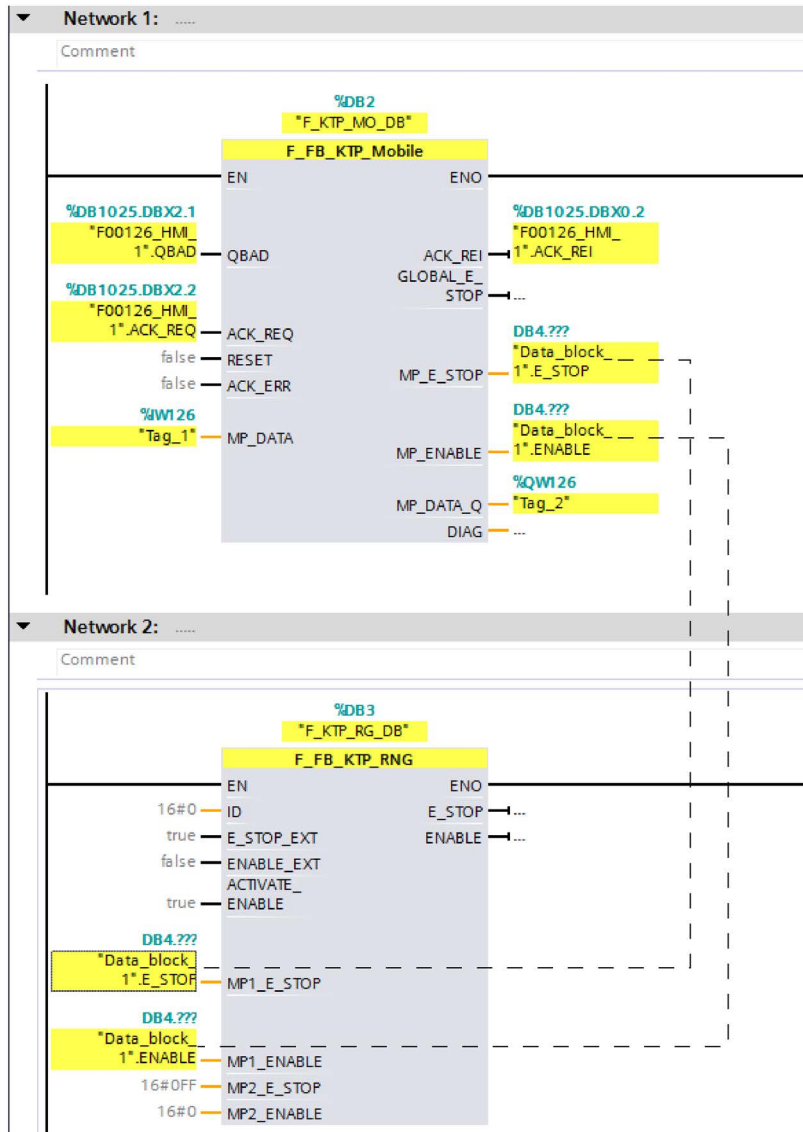

Do the same for the following application scenarios:

- Interconnect a connection box to F_FB_KTP_RNG via the ID input.
- Interconnect a second HMI device to F_FB_KTP_RNG via MP2_E_STOP and MP2_ENABLE.
- Cascade multiple F_FB_KTP_RNG to operate an HMI device on multiple connection boxes.

You can find additional information about these applications as well as the function blocks F_FB_KTP_Mobile and F_FB_KTP_RNG in the following section: "Mobile Panel 2nd Generation F-FBs (Page 258)".

13. Compile the project by right-clicking the fail-safe controller and selecting the following shortcut menu commands in sequence:

- "Compile > Hardware (rebuild all)"
- "Compile > Software (compile all blocks)"

You can transfer the project to the fail-safe controller and the HMI device.

Application example

You can find a Getting Started and a detailed application example including TIA Portal project on the Internet (<https://support.industry.siemens.com/cs/ww/en/view/103497649>).

6.3 Configuring plant areas in WinCC

6.3.1 Overview

If you use multiple connection boxes in several plant areas, you can use connection point recognition to determine the connection box used to connect an HMI device and the plant area in which it is located. This provides the following functions, for example:

- Display of screens on the HMI device for specific plant areas
- Emergency stop or stop for fail-safe Mobile Panels in specific plant areas in an F-system.

This section describes how to configure a connection point recognition and screens for specific plant areas.

A PROFIsafe-based F-system can be configured as follows:

6.3.2 Configuring connection point detection

You can read out the box ID of the connection box to which the Mobile Panel is connected from the project. This section describes the associated configuration steps.

Requirement

- The box ID is set via the rotary coding switch of the connection box, see section "Setting the box ID of the connection box (Page 70)".
- The corresponding project has been opened in the TIA Portal.

Procedure

Creating the "Box ID" tag

1. Add a Mobile Panel to the "Project tree" under "Devices" or select an existing Mobile Panel.
2. Open "Fail-safe Mobile Panel > Runtime settings".

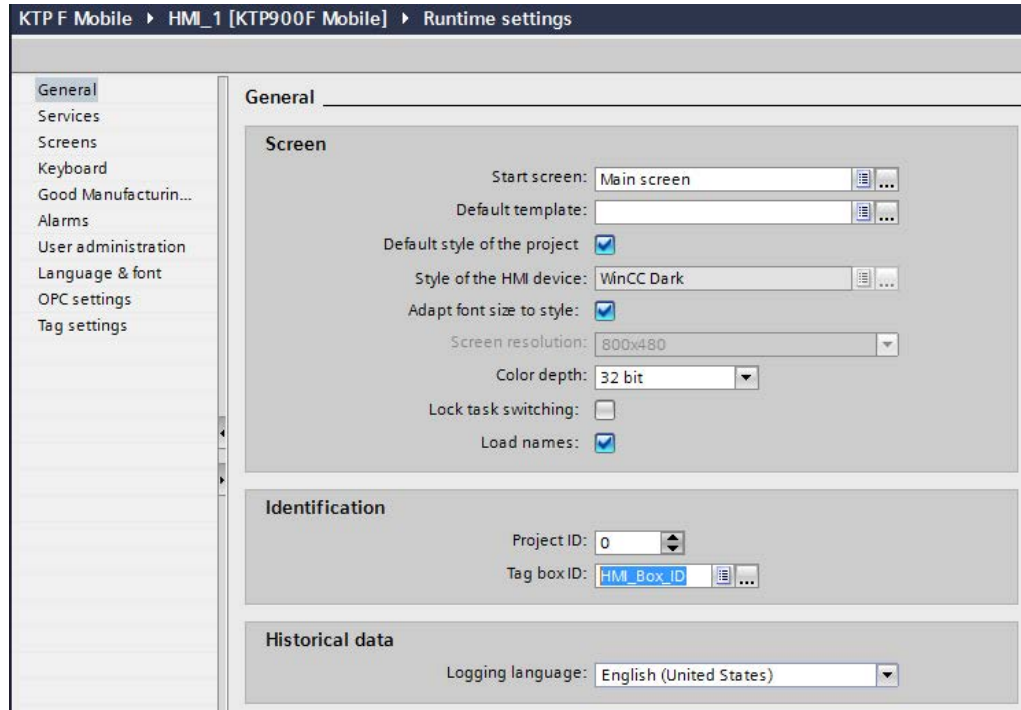

3. Select an existing HMI tag or create a new HMI tag in the "Tag box ID" box of the "Identification" area. If you are adding an HMI tag, select the Integer data type ("Int").
4. Confirm your entry.
The dialog closes and the HMI tag is displayed in the "Tab box ID" box.

The "Box ID" tag has been created. This tag always contains the number of the connection box with which the Mobile Panel is connected as a tag value.

Note

The "Box ID" tag is read-only. Manually overwriting the value of the "Box ID" tag is not permitted.

6.3.3 Configuring zones and start screens

If you have divided your plant into plant areas, you can add a start screen for each configured connection point. In the TIA Portal, plant areas are created in the project tree under "Zone".

Requirement

- Connection point recognition is configured.
- The corresponding project has been opened in the TIA Portal.

Procedure

1. Select "Project tree > Devices > KTPxxx > Zones".
2. Add one or more zones in the editor. Box ID, Name and Display name can be edited.

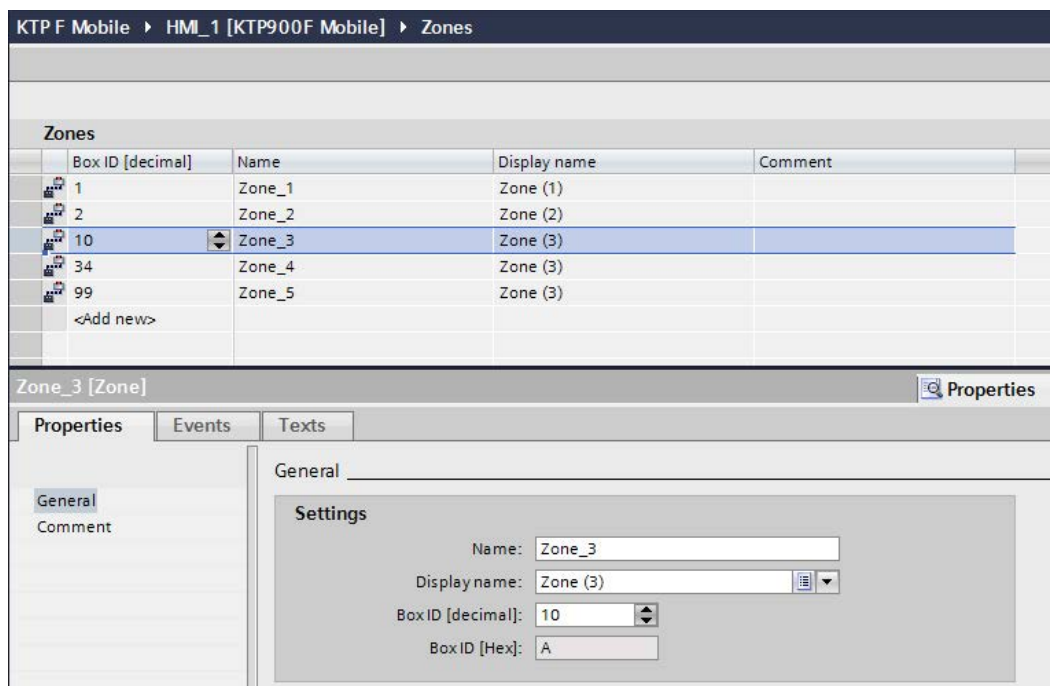

Note

There must be a connection box for each box ID in the list on which the same box ID is set via the rotary coding switches.

When you select a zone, the box ID is displayed in addition to the name and display name in decimal form and in hexadecimal form in the Inspector window under "Properties > General".

3. In the Inspector window, select "Properties > Events" > Connect > Add function".

4. Select "ActivateScreen".

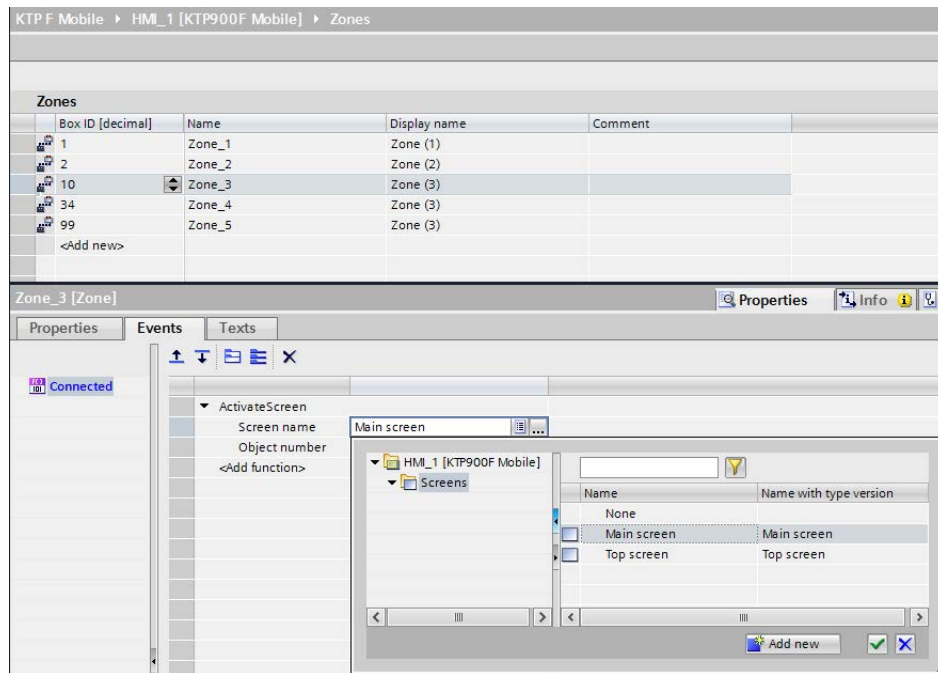

5. Select an existing screen or create a new screen for the selected zone.

6. Confirm your entries.

The plant areas are assigned the required screens.

See also

Configuring connection point detection (Page 179)

Setting the box ID of the connection box (Page 70)

6.4 Additional configuration options in WinCC

6.4.1 Configuring function and direct keys

Configure the following operator controls for the Mobile Panel based on a plant and plant area:

- Function keys

Configure the function keys as required so that you can use operator controls such as the message display, trend view, recipe view and Status/Force.

The function assigned locally to a function key may vary from screen to screen. A function key can only be assigned one function within a screen, either a global or local one. The local assignment function takes priority over the global setting.

- Direct keys

The following objects can be configured as direct keys:

- Buttons
- Function key
- Screen number

When screen numbers are used, the configuration engineer can configure direct keys on a screen-specific basis.

Note

- You can only use direct keys if there is a connection over PROFINET IO.
 - Direct keys create an additional base load for the HMI device.
-

You can find additional information about configuring in the online help of WinCC (TIA Portal) under "Visualizing processes > Communicating with PLCs".

6.4.2 Setting the transfer mode

If you do not only want to start transfer from the Mobile Panel, you can configure a specific operating element. Configure the "SetDeviceMode> Load" system function for an event of an operator control, for example, for a button. If required, configure the corresponding data channel on the configuration PC.

You can find more information on this topic in the online help of WinCC (TIA Portal).

6.4.3 Changing the operating mode

You can configure an operating element to allow you to change the operating mode on the HMI device during runtime. Configure the "SetDeviceMode" system function for an event of an operator control, for example, for a button. The following operating modes are available: "Online", "Offline", "Load". The "Load" operating mode in the configuration software corresponds to the "Transfer" mode on the HMI device.

If required, configure the corresponding data channel on the configuration PC.

You can find more information on this topic in the online help of WinCC (TIA Portal).

6.5 Controlling and evaluating operator controls and display elements

6.5.1 Overview

The following information can be transferred between the HMI device and the PLC depending on the configuration of your HMI device:

- Status of the function keys
- Status of the keyswitch
- State of the illuminated pushbuttons
- Status of the LEDs of function keys and illuminated pushbuttons

Note

The status of the function keys and corresponding LEDs is communicated as soon as a corresponding project has started on the HMI device.

The status of the keyswitch, illuminated pushbuttons and corresponding LEDs is communicated as soon as the HMI device is connected to a connection box.

The options for transmitting information are as follows:

- Direct keys
These are described in "Evaluating operator controls as direct keys (Page 184)".
- System functions of WinCC
These are described in
"Controlling the LEDs of the function keys by means of system functions (Page 187)".

6.5.2 Evaluating operator controls as direct keys

You can configure the operator controls of the HMI device as direct keys. The states of the following operator controls are available directly in the I/O area of the PLC:

- The switching state of the function keys
- The switching state of the keyswitch
- The switching state of the illuminated pushbuttons

Byte assignment

The tables below show the assignment of the key inputs and LED outputs to the bytes in the PLC process image. Refer to your plant documentation for additional information.

6.5 Controlling and evaluating operator controls and display elements

• KTP400F Mobile

Direct keys bit							
7	6	5	4	3	2	1	0
				F4	F3	F2	F1
K2	K1						
7	6	5	4	3	2	1	0
15	14	13	12	11	10	9	8
23	22	21	20	19	18	17	16
31	30	29	28	27	26	25	24

Byte
n
n + 1
n + 2
n + 3
n + 4
n + 5

LED bit							
7	6	5	4	3	2	1	0
				F4	F3	F2	F1
K2	K1						

- F Bit for function key
- K1 Bit for left illuminated pushbutton
- K2 Bit for right illuminated pushbutton

• KTP700 Mobile and KTP700F Mobile

Direct keys bit							
7	6	5	4	3	2	1	0
F8	F7	F6	F5	F4	F3	F2	F1
K2	K1	S1	S0				
7	6	5	4	3	2	1	0
15	14	13	12	11	10	9	8
23	22	21	20	19	18	17	16
31	30	29	28	27	26	25	24

Byte
n
n + 1
n + 2
n + 3
n + 4
n + 5

LED bit							
7	6	5	4	3	2	1	0
F8	F7	F6	F5	F4	F3	F2	F1
K2	K1						

- F Bit for function key
- S Bit for keyswitch
- K1 Bit for left illuminated pushbutton
- K2 Bit for right illuminated pushbutton

The bytes "n + 2" to "n + 5" contain the direct key bits for touch buttons.

• KTP900 Mobile and KTP900F Mobile

Direct keys bit							
7	6	5	4	3	2	1	0
F8	F7	F6	F5	F4	F3	F2	F1
K2	K1	S1	S0			F10	F9
7	6	5	4	3	2	1	0
15	14	13	12	11	10	9	8
23	22	21	20	19	18	17	16
31	30	29	28	27	26	25	24

Byte
n
n + 1
n + 2
n + 3
n + 4
n + 5

LED bit							
7	6	5	4	3	2	1	0
F8	F7	F6	F5	F4	F3	F2	F1
K2	K1					F10	F9

- F Bit for function key
- S Bit for keyswitch
- K1 Bit for left illuminated pushbutton
- K2 Bit for right illuminated pushbutton

The bytes "n + 2" to "n + 5" contain the direct key bits for touch buttons.

Bit assignment

The tables below show the bit coding for function keys, keyswitches and illuminated pushbuttons:

- Bit assignment of the function keys

State	State of the associated function key bit
Not pressed	0
Pressed	1

- Bit assignment of function key LEDs

State	State of the associated LED bit
LED not illuminated	0
LED is illuminated	1

- Bit assignment of the keyswitch

State	S1	S0	Key position
Position 0	0	0	In middle position
Position I	0	1	Turned in clockwise direction up to stop
Position II	1	0	Turned counter-clockwise up to stop

- Bit assignment of the illuminated pushbuttons

State	K1	K2
Not pressed	0	0
Pressed	1	1

- Bit assignment of the illuminated pushbutton LEDs

State	K1	K2
Off	0	0
On permanently	1	1

6.5.3 Controlling the LEDs of the function keys by means of system functions

LEDs are integrated in the HMI device's function keys. The connected PLC can control the integrated LEDs. For example, the LED signals to the operator that they should or can operate the corresponding function key during project runtime.

The following table shows the possible states of the LEDs and the corresponding entries in bit n+1 and bit n of the LED tags.

Bit n+ 1	Bit n	LED status
0	0	Off
0	1	Flashing quickly
1	0	Flashing slowly
1	1	ON, continuous

6.5.4 Controlling and evaluating the illuminated pushbutton by means of system functions

The illuminated pushbuttons are operator controls of the HMI device. The connected PLC can control the integrated LEDs. For example, the LED signals to the operator that they should or can operate the corresponding illuminated pushbutton. Evaluation is run as soon as the HMI device is connected to a connection box.

The following table shows the bit assignment for the status tags of the illuminated pushbuttons:

Bit 0	Status of the illuminated pushbutton
0	Not pressed
1	Pressed

The following table shows the bit assignment for the LED tags of the illuminated pushbuttons:

Bit n+ 1	Bit n	LED status
0	0	Off
0	1	Flashing quickly
1	0	Flashing slowly
1	1	ON, continuous

6.5.5 Evaluating the key-operated switch by means of system functions

The keyswitch is an operator control of the KTP700F Mobile and of the KTP900F Mobile. For example, the keyswitch can be used to lock certain functions. Evaluation is run as soon as the HMI device is connected to a connection box.

The following table shows the bit assignment for the tag of the keyswitch:

Bit 1	Bit 0	Key position
0	0	Central position
0	1	Turned in clockwise direction up to stop
1	0	Turned counter-clockwise up to stop

Note

If you use a tag of the "Boolean" type for the keyswitch, the following assignment applies:

- Status "0": Central position of the keyswitch
 - Status "1": Keyswitch turned clockwise or counter-clockwise to the stop
-

Commissioning a project

7.1 Overview

Configuration phase

A project – the process image of the working process – is produced during configuration to visualize automated working processes. The process displays for the project contain displays for values and messages which provide information about process statuses. The process control phase follows the configuration phase.

Process control phase

The project must be transferred to the HMI device if it is to be used in process control. Another requirement for process control is that the HMI device is connected online to a controller. Current working processes - operating and observing - can then be subject to process control.

Commissioning and recommissioning

Initial and re-start-ups differ in the following respects:

- When the HMI device is commissioned there is no project at first.
The HMI device is also in this state after the operating system has been updated.
- When recommissioning, any project already on the HMI device is replaced.

Operating modes

The HMI device may be in the following operating modes:

- Offline
- Online
- Transfer

"Offline mode" and "Online mode" can be set on both the configuration PC and the HMI device if a corresponding operating element has been configured.

"Offline" operating mode

In this mode, there is no communication between the HMI device and PLC. Although the HMI device can be operated, it cannot exchange data with the PLC.

"Online" operating mode

In this mode, the HMI device and PLC communicate. You can operate the plant with the HMI device in accordance with the configuration.

"Transfer" mode

In this mode, you can transfer a project from the configuration PC to the HMI device or backup and restore HMI device data, for example.

The following options are available for setting "Transfer" mode on the HMI device:

- When the HMI device starts up
Start "Transfer" mode manually in the HMI device Start Center.
- During operation
Start the "Transfer" mode manually within the project using an operating element. The HMI device toggles to "Transfer" mode during automatic transfer if a transfer is initiated on the configuration PC.

7.2 Using existing projects

To use existing projects on your HMI device, proceed as follows:

- To use an existing WinCC flexible project in WinCC, you need to migrate the project to WinCC.
- If you are using an existing WinCC project that was created for a different HMI device, switch to that HMI device in WinCC.

You can find additional information on migration in the online help of WinCC (TIA Portal).

7.3 Data Transmission Options

The table below shows the possible routes for data transmission between the HMI device and configuration PC.

Function	Data channel
Backup to the SD memory card	SD ¹
Backup to USB flash drive	USB
Restoring	Ethernet
Update operating system	Ethernet
Reset operating system to factory settings	Ethernet
Transferring a project	Ethernet
Installing or removing an option	Ethernet

¹ Not available for KTP400F Mobile

7.4 Transferring a project with WinCC

7.4.1 Configuring data channel and setting transfer mode

Requirement

- The project on the HMI device is complete.

Procedure

1. Proceed as described in the section "Configuring transfer (Page 109)".
2. Set the operating mode "Transfer" in the "Start Center".

7.4.2 Starting the transfer

For a project to run on the HMI device, the project must be transferred to the HMI device from the configuration PC. With a transfer, you particularly specify whether to overwrite existing data on the HMI device such as "User management" or "Recipe data".

Note

- You can transfer a single project using the configuration software or using Pack&Go . On HMI devices with an HMI device image that is compatible with WinCC (TIA Portal) V14 or higher, you can also transfer an individual project using an external storage medium.
 - With automatic transfer, the HMI device only switches to "Transfer" mode automatically if the project is running on the HMI device.
 - If automatic transfer is activated on the HMI device and a transfer is initiated on the configuration PC, the project currently running is automatically closed.
-

Automatic transfer

Automatic transfer is particularly suited for the test phase of a new project because transfer is remote controlled. When automatic transfer is activated, the HMI device automatically switches to "Transfer" mode as soon as a project transfer is started on a connected configuration PC.

Requirement

- The project to be transferred has been opened in WinCC.
- The project tree is displayed.
- The configuration PC is connected to the HMI device.
- Transfer mode is set on the HMI device.

Procedure

1. Select the "Download to device > Software" command in the shortcut menu of the HMI device.
2. When the "Extended download to device" dialog opens, configure the "Transfer settings". Make sure that the "Transfer settings" match the "Transfer settings on the HMI device":
 - Select the "Ethernet" protocol.
With Ethernet or PROFINET you can also configure the network address in the "Devices & Networks" editor in WinCC. You can find more information on this topic in the online help of WinCC (TIA Portal).
 - Configure the corresponding interface parameters on the configuration PC.
 - Make the specific interface or protocol settings on the HMI device as required.
 - Click "Download".

You can open the "Extended download to device" dialog at any time using the menu command "Online > Extended download to device...".

The "Load preview" dialog opens. The project is compiled at the same time. The result appears in the "Load preview" dialog.

3. Check the displayed default settings and change them, if necessary.
4. Click "Download".

The project is transferred to the selected HMI device. If errors or warnings occur during the transfer, alarms are displayed in the Inspector window under "Info> Download".

When the transfer is completed successfully, the project is executable on the HMI device.

NOTICE
Deactivating automatic transfer
If you do not deactivate automatic transfer after the commissioning phase, the HMI device can be inadvertently switched to transfer mode. The transfer mode can trigger unintentional reactions in the system.
Deactivate automatic transfer and lock access to the transfer settings. Assign a password in the Control Panel. This locks access to the "Transfer Settings" dialog and prevents unauthorized changes.

7.4.3 Testing a project

The options for testing a project are as follows:

- Test the project on the configuration PC
You can test a project on a configuration PC, using a simulator. You can find detailed information on this in the online help of WinCC (TIA Portal).
- Offline testing of the project on the HMI device
Offline testing means that communication between the HMI device and the controller is down while the test is being carried out.
- Online testing of the project on the HMI device
Online testing means that the HMI device and the controller communicate with each other during testing.

Perform the tests, starting with the "Offline test", followed by the "Online test".

Note

You should always test the project on the HMI device on which the project will be used.

The test increases the certainty that the project will run error-free on the HMI device.

Requirement

- The project has been transferred to the HMI device.
- The HMI device is in "Offline" mode for the offline test.
- The HMI device is in "Online" mode for the online test.

Procedure

Offline test

In "Offline" mode, you can test individual project functions on the HMI device without them being affected by the controller. Controller tags, therefore, are not updated.

- Test the operating elements and visualization of the project as far as possible without connection to the controller.

Online test

In "Online" mode, you can test individual project functions on the HMI device without them being affected by the controller. Controller tags are updated in this case. You have the option to test all communication-related functions, such as alarms, etc.

- Test the operating elements and views of the project.
 - Check that the screens are correctly displayed.
 - Check the screen navigation.
 - Check the input objects.
 - Enter tag values.

7.5 Backup and restore

7.5.1 Backup and restore with a PC

You can back up and restore the following data found in the internal flash memory of the HMI device with a PC:

- Project and HMI device image
- Password list
- Recipe data

Use one of the following programs for backup and restore:

- WinCC
- ProSave

Information on backup and restoring with WinCC is available in the online help of WinCC (TIA Portal).

7.5.2 Backup and restore with an external storage medium

The various options for backup and restore to an external storage medium over the Control Panel are described in the following chapters:

- Saving to external storage medium – backup (Page 144)
- Restoring from external storage medium – Restore (Page 147)
- Update operating system (Page 149)
- Automatic backup (Page 155), not available for KTP400F Mobile

7.5.3 Backup and restore via ProSave

Note

- If a restore operation is interrupted due to power failure on the HMI device, the operating system of the HMI device may be deleted. In this case, you need to update the operating system as described in "Updating the operating system using ProSave (Page 196)".
 - If a message is output on the HMI device warning of a compatibility conflict during the restore operation, the operating system must be updated.
-

Requirement

- The HMI device is connected to a PC on which ProSave is installed.
- The data channel for the HMI device is configured.

Procedure

Backing up

1. From the Windows Start menu, start ProSave on the PC.
2. Select the HMI device type on the "General" tab.
3. Select the type of connection between the HMI device and the PC.
4. Set the connection parameters.
5. Select the data to be backed up in the "Backup" tab.
6. Select a folder and file name for the "*.BRF" backup file.
7. Set "Transfer" mode on the HMI device.

If automatic transfer mode is enabled on the HMI device, the HMI device automatically sets "Transfer" mode when a backup is initiated.

8. Start the backup operation in ProSave with "Start Backup".

Follow the instructions in ProSave. A status view opens to indicate the progress of the operation.

The system outputs a message when the backup is completed. The relevant data is now backed up on the PC.

Restoring

1. From the Windows Start menu, start ProSave on the PC.
2. Select the HMI device type on the "General" tab.
3. Select the type of connection between the HMI device and the PC.
4. Set the connection parameters.
5. Select the "*.BSF" backup file to be restored from the "Restore" tab.

You can see the HMI device for which the backup file was created and the type of backup data the file contains.

6. Set "Transfer" mode on the HMI device.

If automatic transfer mode is enabled on the HMI device, the device automatically sets "Transfer" mode when a restore operation is initiated.

7. Start the restore operation in ProSave on the PC with "Start Restore".

Follow the instructions in ProSave. A status view opens to indicate the progress of the operation.

When the restore is successfully completed, the data backed up on the PC is now on the HMI device.

7.6 Updating the operating system using ProSave

A compatibility conflict may occur when a project is transferred to the HMI device. This is caused by differences between the versions of the configuration software used and the HMI device image available on the HMI device. If the versions are different, transfer is aborted. A message indicating a compatibility conflict is displayed on the configuration PC.

NOTICE
Data loss
All data on the HMI device, including the project and HMI device password, are deleted when you update the operating system.
Back up any stored data before you update the operating system.

Note

- Any license keys for WinCC options are retained when you update the operating system without reset to factory settings.
 - You may have to calibrate the touch screen after updating the operating system.
 - The firmware of the fail-safe module is updated automatically when the operating system is updated.
-

The project versions can be adapted as follows:

- Update the HMI device image if the project was created with a more recent version of the configuration software.
- Transfer a matching version of the HMI device image if you do not want to adapt the project for the HMI device to the current version of the configuration software for the project.

This section describes the update of the operating system using ProSave. Information on updating the operating system with WinCC is available in the online help of WinCC (TIA Portal).

Requirement

- The HMI device is connected to a PC on which ProSave is installed.
- The data channel between PC and HMI device is configured.
- The required image file is available.

Procedure

1. Switch off power to the HMI device.
2. From the Windows Start menu, start ProSave on the PC.
3. Select the HMI device type on the "General" tab.
4. Select the type of connection between the HMI device and the PC, then set the connection parameters.
5. Select the "OS Update" tab.
6. Under "Image path", select the image file "*.FWF".

The image files are available in the WinCC installation folder under "`Siemens\Automation\Portal V<TIA Portal version>\Data\Hmi\Transfer\<HMI device image version>\Images`".

7. Set "Transfer" mode on the HMI device.

If automatic transfer mode is enabled on the HMI device, the device automatically sets "Transfer" mode when an update is initiated.

8. Select "Update OS" on the PC to run the operating system update.
9. Follow the instructions in ProSave.

A progress bar indicates the progress of the operating system update. A message is displayed when the operating system update is successfully completed.

Note

If an error occurs during the firmware update, you are prompted to restart the HMI device. After restart, you are prompted to reset the HMI device to factory settings.

The operating system has been updated. There is no project on the HMI device.

See also

Reset to factory settings with ProSave (Page 198)

7.7 Reset to factory settings with ProSave

The reset to factory settings is required if the HMI device does not yet have an operating system or if the HMI device operating system is corrupt.

NOTICE
Data loss
All data on the HMI device, including the project and HMI device password, are deleted when you update the operating system.
Back up any stored data before you update the operating system.

Note

Reset to factory settings also resets all parameters of the data channels, the IP address and the PROFINET name of the HMI device and the firmware version of the fail-safe module. Transfer can only be started following reconfiguration of the data channels.

This section describes how to reset to factory settings using ProSave. Information on reset to factory settings with WinCC is available in the online help of WinCC (TIA Portal).

Requirement

- The HMI device is connected to a PC on which ProSave is installed.
- The data channel between PC and HMI device is configured.
- The MAC address of the HMI device is known.

Procedure

1. Select the "Set PG/PC interface" command from the "Start > Control Panel" menu.
2. Select "S7ONLINE (STEP7) -> TCP/IP" from the "Application access point" area.
3. Select the interface which is connected to the HMI device from the "Interface parameterization used" area.
4. Confirm your entries.
5. Start ProSave from the Windows start menu.
6. Select the HMI device type on the "General" tab.
7. Select the type of connection between the HMI device and the PC.

8. Enter an IP address.

NOTICE
<p>Possible address conflict with incorrect IP address</p> <p>Do not use a dynamic IP configuration for "Reset to factory settings". Specify a unique IP address of the subnet in which the configuration PC is located. For the duration of the update process, the HMI device is automatically assigned to the specified address of ProSave.</p> <p>If the HMI device has already been used with WinCC or ProSave use the existing IP address for "Reset to factory settings".</p>

9. Change to the "OS Update" tab.

10. Select the "Reset to factory settings" check box.

A text box opens where you can enter the MAC address.

11. Enter the HMI device's MAC address in the text box.

12. Under "Image path", select the HMI device image file "filename.FWF".

The HMI device image files are available in the WinCC installation folder under "\Siemens\Automation\Portal V<TIA Portal version>\Data\Hmi\Transfer\<HMI device image version>\Images".

13. Start "Reset to factory settings" on the PC with "Update OS".

14. In the Control Panel of the HMI device, open the "OP Properties" dialog and select the "Device" tab.

15. Select "Reboot".

A query is opened.

16. Select "Prepare for Reset".

17. Follow the instructions in ProSave.

A progress bar indicates the progress of the operating system update.

A message is displayed when the operating system update is successfully completed. There is now no project data on the HMI device. The factory settings are restored.

Note

- If you can no longer open the Control Panel on the HMI device because the operating system is missing, switch off the HMI device. Then reset to factory settings and start the HMI device. If the HMI device does not start up, switch it off and on again.
 - When the restore operation has been completed, you may have to recalibrate the touch screen.
-

See also

Updating the operating system using ProSave (Page 196)

7.8 Managing WinCC options

You can install the following WinCC options on an HMI device:

- WinCC options supplied with WinCC for the Engineering System and Runtime
- WinCC options purchased in addition to WinCC for the Engineering System and Runtime

The HMI device type determines which WinCC options can be installed.

For an overview of available WinCC options, refer to "Introduction to WinCC".

Requirement

- The HMI device is connected to the configuration PC.
- The PG/PC interface is set.
- The HMI device is selected in the project tree.
- The HMI device is switched on.

Procedure

1. Select the "Options" command in the "Online > HMI device maintenance" menu.
All available WinCC options and those already installed are shown.
2. Click "Device status" to display the WinCC options installed on the HMI device.
3. To install a WinCC option on the HMI device, select the WinCC option with ">>" from the list of installed WinCC options.
4. Click "<<" to remove a WinCC option from the HMI device.
5. To start the installation or removal, click "OK".

The selected WinCC options have been installed on or removed from the HMI device.

7.9 Transferring a license key

You need a license key for WinCC options to use them on an HMI device. The required license keys are usually supplied on a storage medium, for example, a USB stick. You can also obtain a license key from a license server.

Requirement

- The HMI device is connected to a configuration PC or a PC with the "Automation License Manager".
The "Automation License Manager" is installed automatically with WinCC.
- If you use a configuration PC:
The HMI device is selected in the project tree.

Procedure

1. Open the "Automation License Manager".
2. Start the "Automation License Manager".
 - PC without WinCC installation
Open the "Automation License Manager" from the Windows start menu
 - PC with WinCC installation
Open the "Automation License Manager" from WinCC as follows:
Select the "Authorize/License" command in the "Online > HMI device maintenance" menu.
The "Automation License Manager" starts.
3. Select the "Connect HMI device" command in the "Edit > Connect Target System" menu.
The "Connect Target System" dialog is displayed.
4. Select the "device type" of your HMI device.
5. Select the "connection".
6. Configure the corresponding "connection parameters" in line with the selected connection in the window of the same name.
7. Click "OK".
The connection to the HMI device is established. The connected HMI device is displayed in the left area of the "Automation License Manager".
8. On the left, select the drive on which the license keys are located.
The license keys are shown on the right.
9. Select the required license keys.
10. Drag-and-drop the license keys to the HMI device.
The license keys are transferred to the HMI device.

To back up the HMI device license keys, drag-and-drop the license keys from the HMI device to an available drive. License keys can also be removed from the HMI device with drag-and-drop.

Operating a project

8.1 Overview

Operator input options

You can use the touch screen to make entries.

NOTICE
Unintentional actions
Never carry out multiple operations on the Mobile Panel at the same time. You may trigger unintentional actions that could cause material damage.
Never press more than one operating element on the display at once.

This section describes the operation of a project with the touch screen.

Observing the system documentation

Some operations with the project may require in-depth knowledge about the specific system on the part of the operator. Exercise the necessary care if the plant is in setup mode, for example. Please refer to your plant documentation for additional information.

Operation feedback from operating elements

The HMI device provides operation feedback as soon as it detects that an operating element has been selected. This operation feedback is independent of any communication with the controller. Therefore, this operation feedback does not indicate whether the relevant action is actually executed or not.

Optical feedback from operating elements

The operating element receives the focus and is selected. The configuration engineer can also configure the selection of an operating element so that it deviates from the standard. Refer to your system documentation to find any additional information on this topic.

The type of optical feedback depends on the operating element:

- Buttons

The HMI device generates different views for the "Pressed" and "Unpressed" states, provided the configuration engineer has configured a 3D effect:

- "Pressed" state:



- "Unpressed" state:

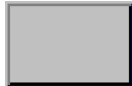

The configuration engineer determines the appearance of a selected field, for example, line width and color for the focus.

- Invisible button

By default, an invisible button is displayed as not pressed when it is selected. No optical operation feedback is provided in this case.

The configuration engineer may, however, configure invisible buttons so that their outline appears as a line when touched. The line remains visible until another operating element is activated.

- I/O field

When you select an I/O field, the content of the I/O field is displayed against a colored background. With touch operation, a screen keyboard opens for entering values.

See also

Control Panel (Page 90)

8.2 Function keys

The function keys are shown in "Design of the Mobile Panels (Page 14)". A function key can be assigned a global or a local function.

- Function keys with global function assignment

A globally assigned function key always triggers the same action on the HMI device or in the controller regardless of the screen displayed. Such an action could be, for example, the activation of a screen or the closure of an alarm window.

- Function keys with local function assignment

A function key with local function assignment is screen-specific and is therefore only effective within the active screen.

8.3 Direct keys

Direct keys on the HMI device set bits directly in the I/O area of a SIMATIC S7 controller. A direct key enables operation with a short response time, for example, as required for setup mode.

Read "Evaluating operator controls as direct keys (Page 184)".

Note

- You can only use direct keys when there is a connection over PROFINET IO.
 - The direct key function is available or active from the following time:
 - Key switches, illuminated pushbutton and corresponding LEDs:
As soon as the HMI device is supplied with power.
 - Function keys with direct key functionality and corresponding LEDs:
As soon as a corresponding project is started on the HMI device.
 - Direct keys are still active when the HMI device is in "offline" mode.
 - If you operate a function key with direct key functionality when a project is running, the direct key function is always executed, regardless of the current display content.
-

Note

Direct key LEDs

If keys of the HMI device that are equipped with an LED are used as direct keys over PROFINET IO, the following applies:

- After the device is switched on, the LEDs of the direct keys do not light up.
 - As soon as the PROFINET IO connection is established, the LEDs of the direct keys light up.
 - If no direct key communication exists or a PROFINET IO communication error occurs, e.g. due to faulty check bits, the LEDs of the direct keys are no longer lit.
-

8.4 Setting the project language

The HMI device supports multilingual projects. You must have configured a corresponding operating element which lets you change the language setting on the HMI device during runtime. The project always starts with the language set in the previous session.

You can change project languages at any time. Language-specific objects are immediately output to the screen in the new language when you switch languages.

Requirement

- The required language for the project is available on the HMI device.
- The language switching function was logically linked to an operating element during configuration.

Procedure

- Press the relevant operating element.
The following options are available for switching the language:
 - The configured HMI device switches to language selection.
 - The configured operating element activates the required language directly.Please refer to your plant documentation for additional information.

8.5 Entering and modifying the value, date and time

Values

The following types of value can be entered:

- Numerical value

You can enter a numerical value using the screen keyboard.

Note

- When the screen keyboard is open, job mailbox 51, "Select screen" has no function.
 - The screen keyboard display is independent of the configured project language.
-

- Alphanumerical value

Input is as for numerical values.

- Hexadecimal value

When a text box for hexadecimal values has been configured, the letters "A" to "F" are also available in addition to the digits. The keys "G" to "Z" on the screen keyboard are not used.

- Date and time

Date and time are entered as are numerical values.

Note

When entering the date and time, note that their format is determined by the configured project language.

Value check

- Limit test of numerical values
A tag can be configured with limits. If you enter a value outside these limits it will not be accepted, for example, "80" is rejected if the configured limit is "78". If an alarm window is configured, a system alarm is output on the HMI device and the original value is displayed again.
- Decimal places for numerical values
The number of decimal places can be specified for a numerical text box. The number of decimal places is checked when you enter a value in this type of text box.
 - Decimal places in excess of the limit are ignored.
 - Empty decimal places are filled with "0".

Requirement

- A text box has been selected.
- The screen keyboard is displayed.

Procedure

1. Enter the relevant value.
2. To discard the input, press <ESC>.
If you have discarded the entry, the text box remains empty or the original value is displayed.
3. To confirm the entry, press <ENTER>.
The value has been entered or changed.

8.6 Displaying infotext

Infotext provides additional information and operating instructions. Infotext can be configured for a screen or operating object. The infotext of an I/O field may contain, for example, information on the value to be entered.

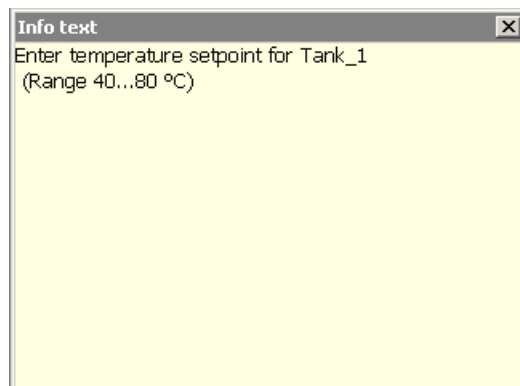

An infotext that is available for an operating object is displayed with the <Help> key on the screen keyboard. Depending on the configuration, infotext may also be accessed with an operating object. Please refer to your system documentation for additional information.

Requirement

- Operating element with configured infotext is selected.

Procedure

1. Press the <HELP> key.
The infotext for the screen or operating object is displayed.

Note

The configuration engineer can configure infotext for an I/O field and the associated screen. You can switch between two infotexts by touching the infotext window.

2. Close the window with the infotext.

8.7 Closing the project

Procedure

1. Use the corresponding operator control object to close the project.
The following only applies to fail-safe Mobile Panels: When PROFIsafe communication is active, the "Confirm logoff" dialog is displayed. Confirm the logoff in the corresponding dialog.
2. Wait for the Start Center to be displayed.
3. Pull out the connecting cable if required, as described in section "Unplugging the connecting cable (Page 211)".

Fail-safe operation

The content of this section applies only to fail-safe Mobile Panels in a hardwired or PROFIsafe-based F-system.

9.1 Connecting the connecting cable

NOTICE

The status of keyswitch and illuminated pushbuttons is evaluated immediately after connection.

When you connect an HMI device to the connection box and evaluate operator controls over PROFINET IO as direct buttons:

The status of the keyswitch, the illuminated pushbuttons and the corresponding LEDs is evaluated immediately. This can cause unintentional responses.

Check the position of the keyswitch and do not activate the illuminated pushbutton before or during connection.

Requirement

- The Mobile Panel is ready for operation.
- There is a project on the Mobile Panel.

Procedure

Connecting to a connection box without an assigned operating mode

Note

If the connection box has not yet been assigned an operating mode, the emergency stop / stop button does not light up when the connecting cable is plugged in.

1. Plug the connecting cable into a connection box.
The "Safety operation" dialog is displayed.
2. Select the required operating mode as described in "Assigning a safety-related operating mode (Page 142)".
3. Start the project.

The emergency stop / stop button does or does not light up depending on the selected operating mode, see the following sections.

9.1 Connecting the connecting cable

Connection to a connection box with the assigned operating mode "Stop button evaluated by safety relay"

- Plug the connecting cable into a connection box.
The project starts as configured in the Control Panel. The project start screen appears after startup.
The stop button is active and does not light up.

Connection to a connection box with the assigned operating mode "E-stop button evaluated by safety relay"

- Plug the connecting cable into a connection box.
The project starts as configured in the Control Panel. The project start screen appears after startup.
The emergency stop button is active and lights up.

Connection to a connection box with the assigned operating mode "E-stop button evaluated by PROFIsafe"

- Plug the connecting cable into a connection box.
The project starts as configured in the Control Panel.
PROFIsafe communication is established.
The Mobile Panel is logged on automatically in the safety program.
The project start screen appears after startup.
The emergency stop button is active and lights up.

Response to errors

1. If an error occurs after you attach the connecting cable, a corresponding error message is displayed.
2. Check the connecting cable and the plug-in connection on the connection box. Read the message text and follow the instructions in the error message

You can find additional information on error scenarios in the following sections:

- Safety-related dialogs (Page 212)
- Troubleshooting (Page 267)

See also

Connecting the KTP Mobile connecting cable to the connection box (Page 73)

Entering and deleting a password (Page 105)

9.2 Unplugging the connecting cable

Requirement

- A project is running on the Mobile Panel.
- For a PROFIsafe-based F-system:
The Mobile Panel is logged on to the F-CPU via the safety program.

Procedure

PROFIsafe-based F-system

NOTICE
<p>Logoff required</p> <p>In a PROFIsafe-based F-system, logoff from the safety program is required before unplugging the connecting cable.</p> <p>If you unplug the connecting cable without logoff, the plant will switch to a safe operating state.</p>

1. If you want to switch the Mobile Panel to another connection box, close the fail-safe communication via the corresponding operator control.
If you want to shut down and switch off the Mobile Panel, close the currently active project.
2. Confirm the logoff in the corresponding dialog.
The Mobile Panel is logged off the safety program. PROFIsafe communication stops after a successful logoff.
3. When the emergency stop button no longer lights up, unplug the connecting cable.

Hardwired F-system

NOTICE
<p>Connection box compact and connection box standard</p> <p>When unplugging the connecting cable from the connection box compact or a connection box standard, there is no automatic bypass of the emergency stop / stop circuit. Without further actions, an emergency stop or stop is triggered in the plant and the plant switches to a safe state.</p> <p>Take appropriate circuitry measures to prevent an undesired emergency stop or stop of the plant.</p>

1. Unplug the connecting cable.
The emergency stop button is no longer active and no longer lights up.

Switching to another connection box

KTP400F Mobile

The following applies to the KTP400F Mobile: To change to a different connection box, proceed as described in the previous section "Procedure" and then connect the HMI device with a different connection box.

KTP700 Mobile, KTP700F Mobile, KTP900 Mobile, KTP900F Mobile

For all Mobile Panels 2nd Generation with the exception of the KTP400F Mobile: If you have unplugged the connecting cable of the Mobile Panel from the connection box, the project will remain active on the Mobile Panel for the duration of the bypass period.

Note

Recovery time 1 second

After the connecting cable is unplugged from the connection box, the HMI device changes to standby mode in a defined manner. The time needed for this process is approximately 1 second. Do not reconnect the HMI device to the connection box immediately after disconnecting it. Wait at least 1 second.

Bypass period 5 minutes

You can reconnect the HMI device to a connection box within 5 minutes and continue working in the project.

The HMI device switches off when the bypass period has elapsed.

9.3 Safety-related dialogs

9.3.1 "End PROFIsafe communication" dialog

The "Terminate PROFIsafe connection" dialog opens in the following situations:

- You have pressed an operator control to close the PROFIsafe connection.
- You have pressed an operator control to close the currently active project.



- To end PROFIsafe communication, press "Yes".
Wait until the emergency stop button is no longer lit up in red. Only then has fail-safe communication ended.
- If you do not want to stop PROFIsafe communication, press "No".
The dialog closes. Fail-safe communication remains active.

9.3.2 "Confirm communication error" dialog

The following message is displayed when PROFIsafe communication is available again after a communication error.



Acknowledge the communication error with the enabling button or confirm the communication error on the fail-safe controller.

9.3.3 "Fatal Error" dialog

If the fail-safe module detects a serious error, the fail-safe automation system outputs the "Fatal error" alarm. The fail-safe module must then be reset.



Note

This message may also occur if the Mobile Panel overheats. Check the ambient conditions.

Displaying error codes and resetting the fail-safe module

1. If you want to view the error codes of the fail-safe module with respect to the associated controllers, open the "Show Error List" dialog with the "Show fatal errors" link.

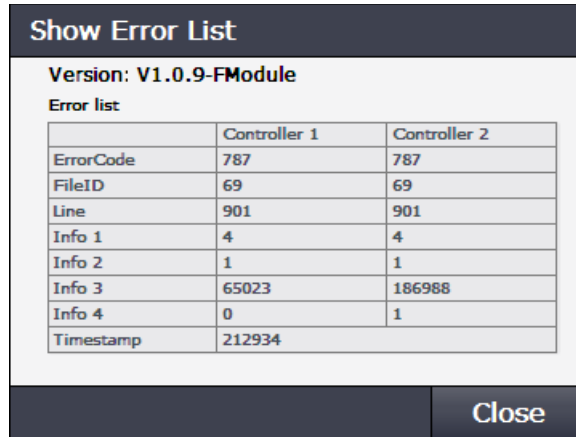

Make a note of the entry under "Version" and the content of the "Error List".

2. Close the dialog with the "Close" button.
3. Click the "Reset safety module" button.

The fail-safe module of the Mobile Panel restarts; the fail-safe automation system continues to run in fail-safe mode.

If the error persists, please contact Technical Support, see section "Service and support (Page 268)". Have ready the data you wrote down in the first step.

Discrepancy error

The following table shows the discrepancy warnings. If these warnings occur more frequently, you must send in the device for repair.

Error message	Meaning
789 Internal discrepancy error (0)	Discrepancy at the emergency stop button
789 Internal discrepancy error (1)	Discrepancy at acknowledgment button switch position 2
789 Internal discrepancy error (2)	Discrepancy at acknowledgment button switch position 3

Maintenance and care

10.1 General information on maintenance and servicing

Observe the following when servicing and repairing protective equipment e.g. such as ground circuits or overvoltage protection components:

- Observe the maintenance and replacement intervals.
- Replace system components, including external cables, fuses and batteries only with equivalent components approved by the respective manufacturer.

10.2 Replacing the Mobile Panel

When replacing an HMI device, the following applies:

- A fail-safe Mobile Panel may only be replaced by another fail-safe Mobile Panel.
- For a 1:1 data transfer from one HMI device to another, a replacement device with identical construction is required.
- If you do not use an identical replacement device, you have to adapt the configuration and transfer the adapted project to the replacement device. During adaptation of the project, observe the following:
 - The display size of the HMI devices
 - The number of used direct keys
 - The evaluation of the keyswitch
 - The use of the "automatic backup" function
 - The information on switching devices in the WinCC information system

Below you will find a description of how to replace an HMI device with a replacement device with identical construction.

Replacement device with identical construction, manual backup exits

1. Insert the storage medium with the manually created backup into the slot of a replacement device with identical construction.
2. Proceed as described in the section "Restoring from external storage medium – Restore (Page 147)".

Replacement device with identical construction, automatic backup exists

The "Automatic backup" function is available on all Mobile Panels 2nd Generation with the exception of the KTP400F Mobile.

With automatic backup, the HMI device stores all data required for operation on the SD memory card. You can insert the memory card into any HMI device of the same type.

Note

If you use the backup on the storage medium for another HMI device of a different type, an error message will appear. The backup can only be used for HMI devices of the same type.

1. Remove the storage medium from the defective HMI device.
2. Insert the storage medium into the slot of a replacement device with identical construction.
3. Attach the connecting cable and close the terminal compartment cover.
4. Connect the replacement device to the connection box.
The replacement device starts.
5. Select "Settings > Service & Commissioning".

6. Change to the "Automatic Backup" tab.
7. Press the "Enable & Reboot" button.
The replacement device restarts; after the restart, the "Use system card" dialog appears.
8. Click the "Continue" button.

After the data is copied, the replacement device is ready for operation.

10.3 Servicing the Mobile Panel

The HMI device is designed for low-maintenance operation. Also take into account the system components and accessories when carrying out maintenance. For maintenance, follow the safety instructions in "General safety instructions (Page 31)".

The scope of maintenance includes the following function tests:

- Function test of enabling button
- Function test of emergency stop / stop button

Depending on the Safety Integrity Level SIL of your application, the function tests are performed at the following intervals.

- SIL2: 1 x annually
- SIL3: 1 x monthly

Performing function tests

Function test of enabling button

1. Connect the HMI device to a connection box.
2. Press the enabling button to switch position 2 "Enabling".
3. Check whether the plant reacts to the "Enabling" switch position as defined.
4. Press the enabling button to switch position 3 "Panic".
5. Check whether the plant reacts to the "Panic" switch position as defined.

Function test of emergency stop / stop button

1. Press the emergency stop / stop button.
2. Check whether the plant reacts as defined.
3. Release the locking element of the emergency stop / stop button.
4. Check whether the plant starts up again as defined.

Result

If the function tests were completed successfully, you can continue using the HMI device.

If one of the function tests was not completed successfully, you must replace the HMI device.

See also

Reaction times and safety characteristics for fail-safe operation (Page 239)

10.4 Cleaning the Mobile Panel

The HMI device is designed for maintenance-free operation. You should still clean the HMI device regularly.

Cleaning agents

NOTICE
Damage to the HMI device caused by impermissible cleaning agents
Impermissible and unsuitable cleaning agents may cause damage to the HMI device. Use dish soap or foaming screen cleaner only as cleaning agents. Do not use the following cleaning agents:
<ul style="list-style-type: none">• Aggressive solvents or scouring powder• Steam jets• Compressed air

Observe the information on chemical resistance
(<http://support.automation.siemens.com/WW/view/en/39718396>).

Requirements

- The cover of the USB port and the connection compartment cover are closed.
- Cleaning cloth
- Dishwashing liquid or foaming screen cleaning agent

Procedure

1. For fail-safe HMI devices: Follow the instructions in the section "Unplugging the connecting cable (Page 211)".

For non-fail-safe HMI devices: If a project is running on the HMI device, close the project and pull out the connecting cable from the connection box.
2. Spray cleaning agent onto a cleaning cloth.
Do not spray cleaning agent directly onto the HMI device.
3. Clean the HMI device.
When cleaning the display, wipe inwards from the edge of screen.

See also

General safety instructions (Page 31)

10.5 Spare parts and repairs

If the HMI device needs to be repaired, ship it to the Return Center in Erlangen.
The address is:

Siemens AG
Digital Factory Retouren-Center
c/o Geis Service GmbH, Tor 1-4
Kraftwerkstraße 25a
91056 Erlangen
Deutschland

You can find more detailed information on the Internet at "Spare parts and repairs (<http://support.automation.siemens.com/WW/view/en/16611927>)".

10.6 Recycling and disposal

Due to the low levels of pollutants in the HMI devices described in these operating instructions, they can be recycled.

Contact a certified disposal service company for electronic scrap for environmentally sound recycling and disposal of your old devices, and dispose of the device according to the relevant regulations in your country.

Technical specifications

11.1 Software license agreements

Microsoft licenses

License fees for the pre-installed Microsoft operating system on the HMI devices are paid directly by Siemens to the Microsoft company.

No COA label ("Certificate of Authenticity") and no other proof of license is required for the HMI device.

Open Source Software

Read the software license agreements for Open Source Software on the supplied "Open Source Software License Conditions" data medium.

11.2 Certificates and approvals

Approvals

Note

The following overview shows the possible approvals for the HMI device and the connection boxes. The only valid approvals for the HMI device and the connection boxes themselves are those shown on the nameplate.

CE approval



The Mobile Panel and the connection boxes meet the general and safety-related requirements of the following EU directives and conform to the harmonized European standards for these devices published in the official gazettes of the European Community and in the EU Declarations of Conformity:

- 2014/30/EU "Electromagnetic Compatibility Directive" (EMC Directive)
- 2011/65/EU "Directive of the European Parliament and of the Council of 8 June 2011 on the restriction of the use of certain hazardous substances in electrical and electronic equipment" (RoHS Directive)
- The following also applies for fail-safe Mobile Panels: 2006/42/EC "Machinery Directive"

EU Declaration of Conformity

The EU Declaration of Conformity is available to the relevant authorities at the following address:

Siemens AG
Digital Factory
Factory Automation
DF FA AS SYS
Postfach 1963
D-92209 Amberg, Germany

UL approval



Underwriters Laboratories Inc. in accordance with

- UL 508 (Industrial Control Equipment)
- CSA C22.2 No. 142 (Process Control Equipment)

IEC 61131

The HMI device meets the requirements and criteria according to IEC 61131-2, Programmable Controllers, Part 2: Operating resource requirements and tests.

RCM AUSTRALIA/NEW ZEALAND



This product meets the requirements of EN 61000-6-4 Generic standards – Emission standard for industrial environments.

This product meets the requirements of the standard EN 61000-6-4 Generic standards – Emission standard for industrial environments.

Identification for Eurasian Customs Union



- EAC (Eurasian Conformity)
- Customs union of Russia, Belarus and Kazakhstan
- Declaration of conformity according to Technical Regulations of the Customs Union (TR CU)

Marking for Korea



This product meets the requirements of Korean certification (KC label).

이 기기는 업무용(A급) 전자파적합기기로서 판매자 또는 사용자는 이 점을 주의하시기 바라며, 가정외의 지역에서 사용하는 것을 목적으로 합니다.

This equipment is Industrial (Class A) electromagnetic wave suitability equipment and seller or user should take notice of it, and this equipment is to be used in the places except for home.

See also

Currently valid certificates on the Internet
(<http://support.automation.siemens.com/WW/view/en/101936852/134200>)

WEEE label (European Union)



Disposal instructions, observe the local regulations and the section "Recycling and disposal (Page 218)".

11.3 Standards on operating safety

Plant-related standards

The Mobile Panel and the connection box meet the following standards for use in a plant:

Standard	Title
DIN EN 12417:2001+A2:2009	Machine Tools - Safety - Machining Centres
EN 61000-6-2:2005	Electromagnetic compatibility (EMC) – Part 6-2: Generic standards - Immunity for industrial environments
EN 61000-6-4:2007 + A1:2011	Electromagnetic compatibility (EMC) – Part 6-4: Generic standard - Emission standard for industrial environments
EN 61131-2:2007	The HMI device meets the requirements and criteria according to IEC 61131-2, Programmable Controllers, Part 2: Equipment requirements and testing

TÜV

The TÜV confirms that the Mobile Panel and the connection box satisfy the requirements of the following standards with regard to their safety functions:

Standard	Title
EN 60204-1:2006	Safety of machinery – Electrical equipment of machines – Part 1: General Requirements
DIN IEC 62061:2005 + A1:2012	Safety of machinery – Functional safety of electrical, electronic and programmable control systems for machinery
IEC 61508-1 to 4:2010	Safety Integrity Level 3
DIN EN 13850:2012	Safety of machinery - EMERGENCY STOP - Principles for design
EN ISO 13849-1:2008	Performance Level e and Category 4

11.4 Electromagnetic compatibility

The Mobile Panel and connection box satisfy the requirements of the German EMC Act relating to the European internal market.

EMC-compliant installation

EMC-compliant use of the Mobile Panel and connection box and the use of interference-proof cables are prerequisites for error-free operation.

Observe the following manuals in addition to these operating instructions:

- Designing interference-free SIMATIC S7-1500, ET 200MP, ET 200SP, ET 200AL controllers (<https://support.industry.siemens.com/cs/ww/en/view/59193566>)
- Industrial Ethernet / PROFINET - Passive network components (<https://support.industry.siemens.com/cs/ww/en/view/84922825>)

Disturbance variables

Electromagnetic compatibility applies for the following types of disturbance variables:

- Pulse-shaped disturbance variables

The table below shows the electromagnetic compatibility of the Mobile Panel and the connection boxes with regard to pulse-shaped disturbance variables.

Pulse-shaped disturbance	Tested with	Degree of severity
Electrostatic discharge in accordance with IEC 61000-4-2	Air discharge: 8 kV Contact discharge: 6 kV	3
Burst pulses (high-speed transient interference) in accordance with IEC 61000-4-4	2 kV supply line	3

An external safety circuit is required for the "Surge immunity test according to IEC 61000-4-5", see Function Manual "Designing interference-free SIMATIC S7-1500, ET 200MP, ET 200SP, ET 200AL controllers (<https://support.industry.siemens.com/cs/ww/en/view/59193566>)", section 7 "Lightning protection and overvoltage protection"

Pulse-shaped disturbance	Tested with	Degree of severity
Asymmetrical coupling	2 kV power cable DC voltage with protective elements	3
Symmetrical coupling	1 kV power cable DC voltage with protective elements	3

- Sinusoidal interference

The table below shows the electromagnetic compatibility of the Mobile Panel and the connection boxes with regard to sinusoidal interference.

Sinusoidal interference	Test values	Degree of severity
HF radiation (in electromagnetic fields) in accordance with IEC 61000-4-3	80% amplitude modulation at 1 kHz <ul style="list-style-type: none"> • Up to 10 V/m in the 80 MHz to 1 GHz range • Up to 3 V/m in the 1.4 GHz to 6 GHz range 	3
RF interference current on cables and cable shielding conforming to IEC 61000-4-6	Test voltage 10 V, with 80% amplitude modulation of 1 kHz in the 150 kHz to 80 MHz range	3

The following table shows the unwanted emissions from electromagnetic fields in accordance with EN 55016, Limit Value Class A, Group 1, measured at a distance of 10 m.

30 to 230 MHz	< 40 dB (µV/m) quasi-peak
230 GHz to 1 GHz	< 47 dB (µV/m) quasi-peak
1 GHz to 3 GHz	< 66 dB (µV/m) peak
3 GHz to 6 GHz	< 70 dB (µV/m) peak

Emission of radio interference

Before you connect the HMI device and any connection box to the public electricity network, you must make sure that they comply with Limit Value Class B in accordance with EN 55022.

See also

EMC information in section "Notes about usage (Page 37)".

11.5 Mechanical ambient conditions

11.5.1 Storage conditions

The following information applies to an HMI device and connection box transported and stored in its original packaging. The devices were tested based on IEC 60721-3-2 Class 2M4 with the following amendments and limitations:

Type of condition	Permitted range
Free fall	≤ 0.3 m
Vibration to IEC 60068-2-6	5 ... 8.4 Hz, deflection 3.5 mm 8.4 ... 500 Hz, acceleration 1 g
Shock to IEC 60068-2-27	250 m/s ² , 6 ms, 1000 shocks

11.5.2 Operating Conditions

The following information applies to the HMI device and to the connection box. The devices are designed for operation in a location protected from the effects of the weather. The devices were tested based on IEC 60721-3-3 Class 3M3 with the following amendments and limitations:

Type of condition	Permitted range
Vibration to IEC 60068-2-6	5 ... 8.4 Hz, deflection 3.5 mm 8.4 ... 200 Hz, acceleration 1 g
Shock to IEC 60068-2-27	150 m/s ² , 11 ms, 3 shocks

11.6 Climatic ambient conditions

11.6.1 Long-term storage

The following information applies to a device that is stored in its original packaging for longer than two weeks.

The device meets the requirements according to IEC 60721-3-1 Class 1K21.

11.6.2 Transport and short-term storage

The following information applies to an HMI device and connection box transported and stored in its original packaging.

The device was tested based on IEC 60721-3-2 Class 2K11 with the following amendments and limitations:

Type of condition	Permitted range
Temperature	-20 ... +60 °C
Atmospheric pressure	1140 ... 660 hPa, corresponds to an elevation of -1000 to 3500 m
Relative humidity	10 ... 90%
Pollutant concentration	SO ₂ : < 0.5 ppm; relative humidity < 60%, no condensation H ₂ S: < 0.1 ppm; relative humidity < 60%, no condensation

Note

If dewing has developed, wait until the device has dried completely before switching it on.

Do not expose it to direct heat radiation from a heating device.

11.6.3 Operating Conditions

The following information applies to the HMI device and to the connection box. The devices are designed for operation in a location protected from the effects of the weather. The devices were tested based on IEC 60721-3-3 Class 3K3 with the following amendments and limitations:

Type of condition	Permitted range
Temperature, HMI device	0 ... 45 °C
Temperature, connection boxes	0 ... 55 °C
Atmospheric pressure	1140 ... 795 hPa, corresponds to an elevation of -1000 to 2000 m
Relative humidity	10 ... 90%, no condensation
Pollutant concentration	SO ₂ : < 0.5 ppm; relative humidity < 60%, no condensation * H ₂ S: < 0.1 ppm; relative humidity < 60%, no condensation *

* Mobile Panel, connection box standard and connection box advanced:

No condensation inside the housing

Connection box compact: None condensation on the back

11.7 Dimension drawings

11.7.1 KTP400F Mobile dimension drawing

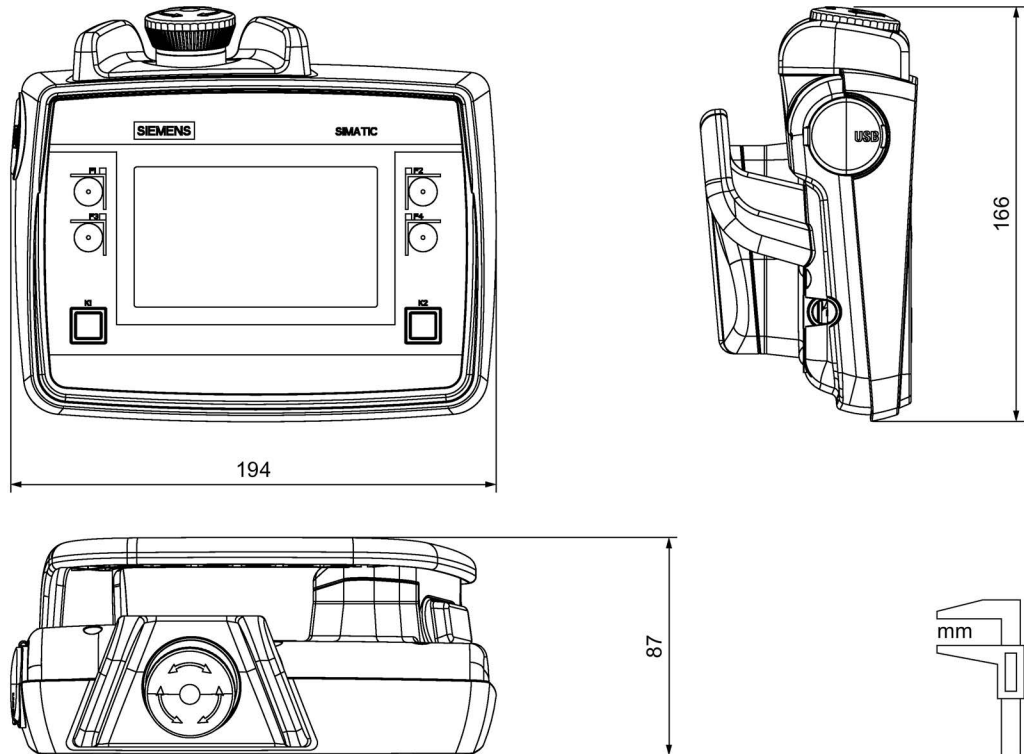

11.7.2 KTP700 Mobile dimension drawing

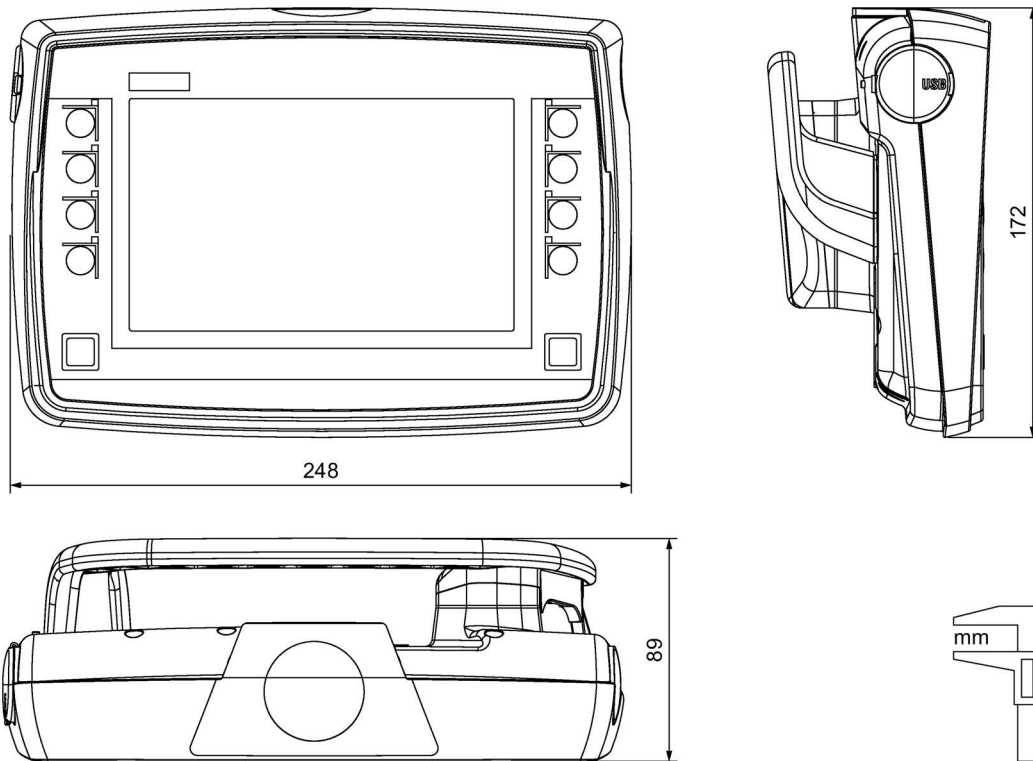

11.7.3 KTP700F Mobile dimension drawing

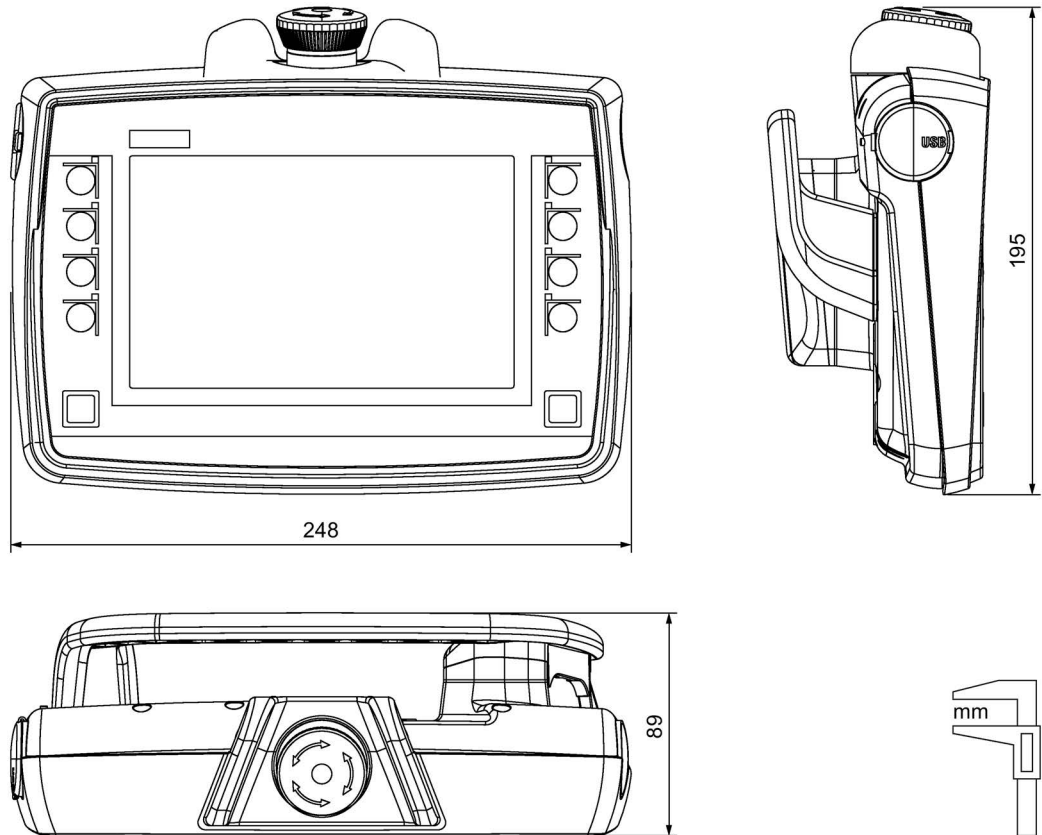

11.7.4 KTP900 Mobile dimension drawing

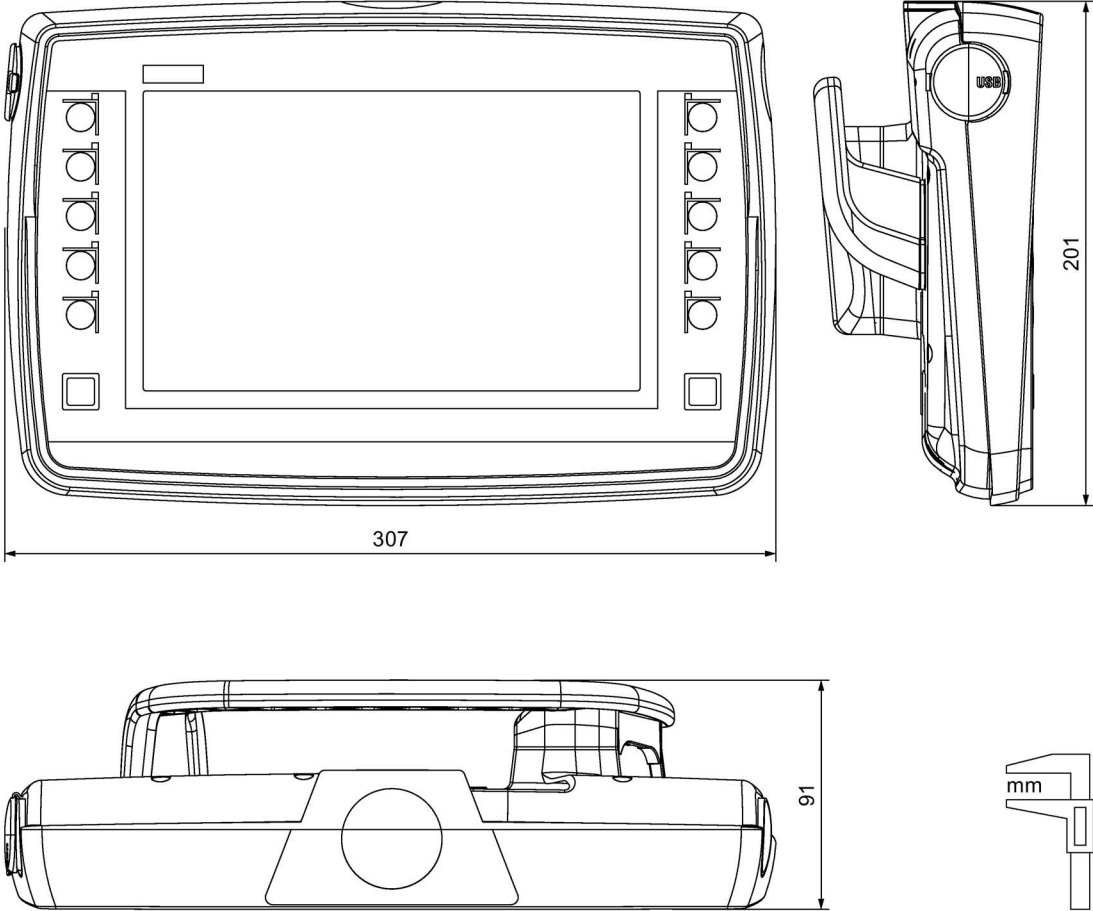

11.7.5 KTP900F Mobile dimension drawing

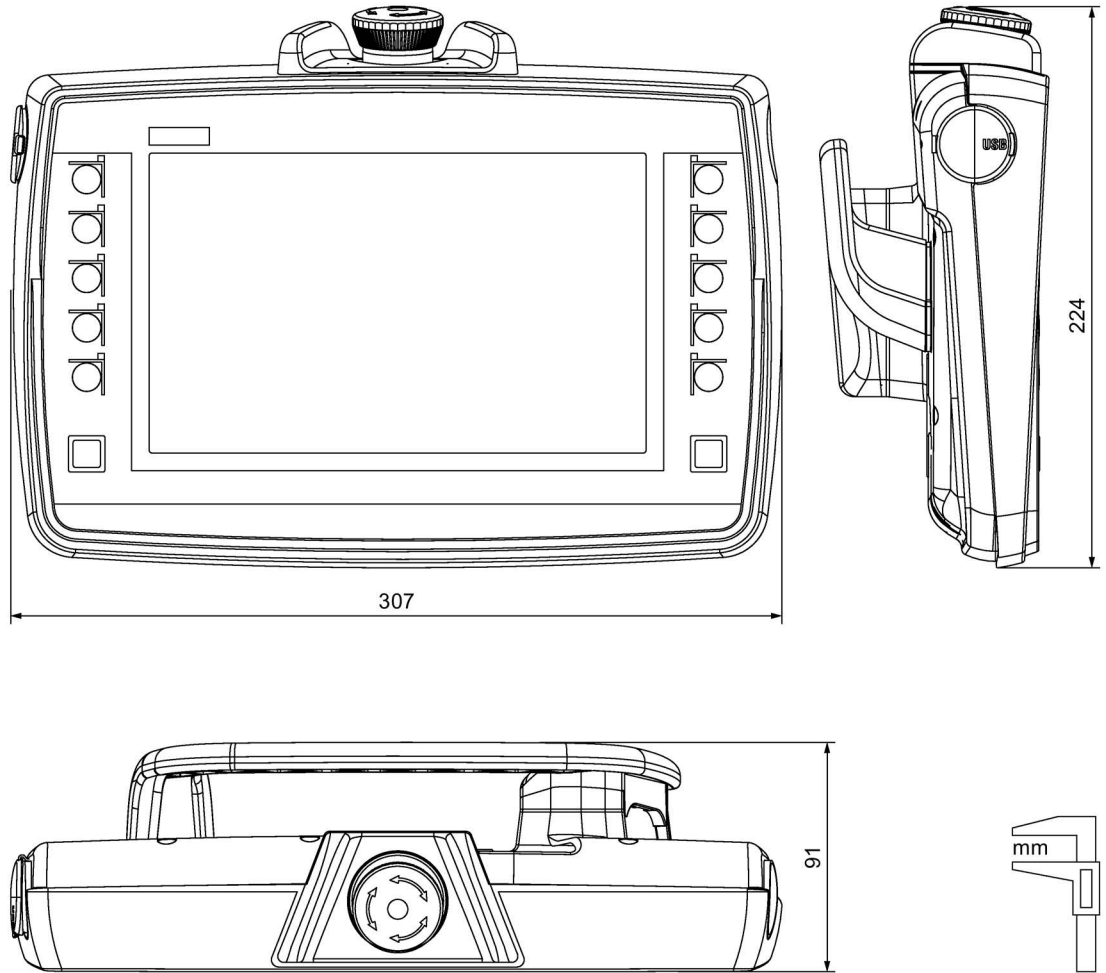

11.7.6 Connection box compact dimension drawing

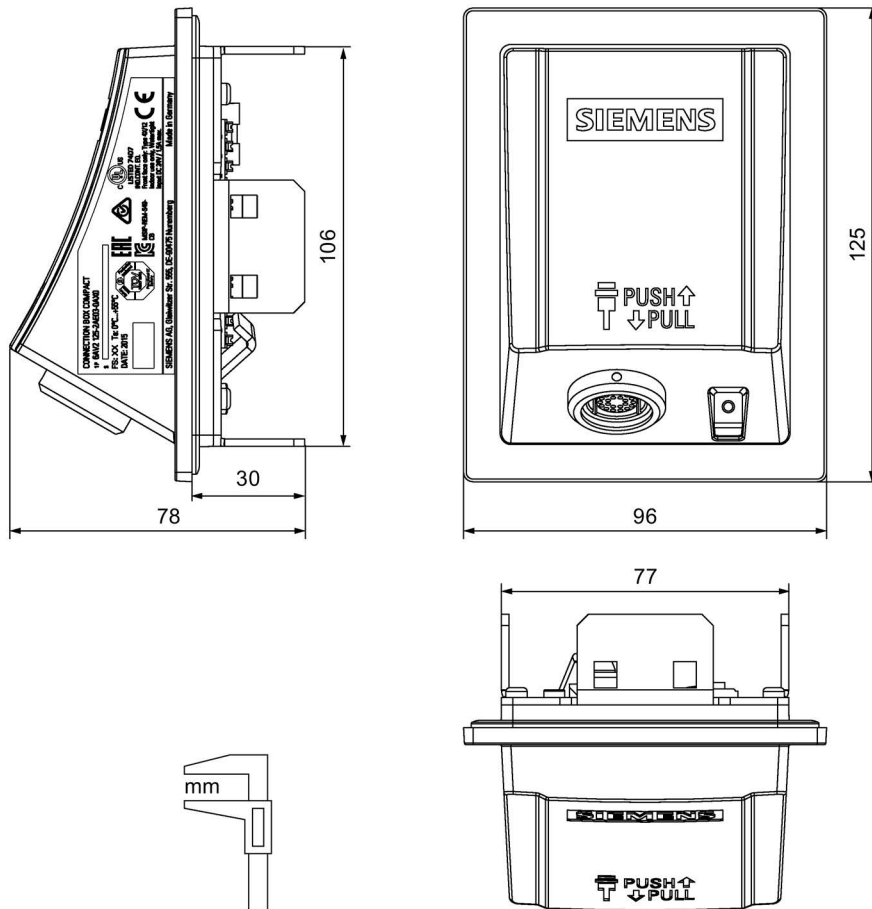

11.7.7 Dimension drawing for connection box standard and connection box advanced

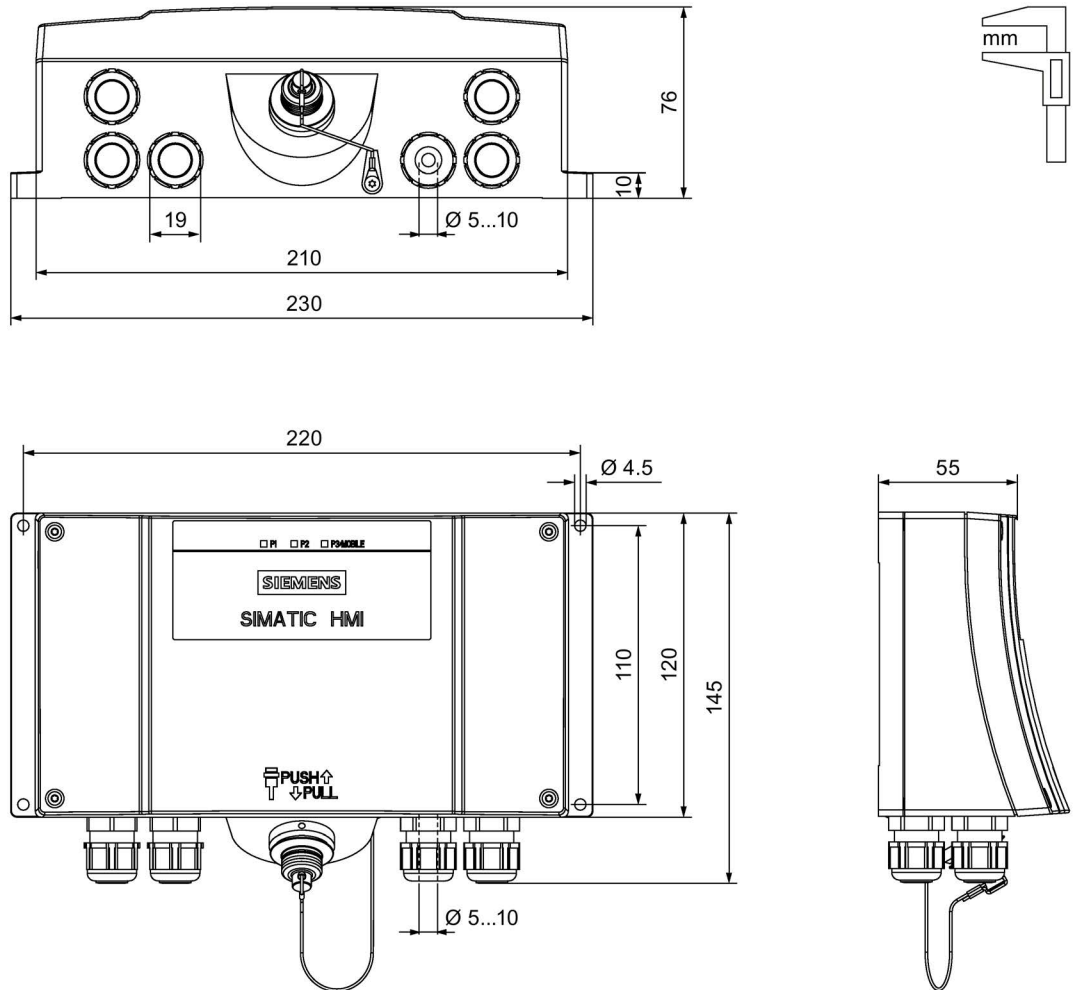

11.7.8 KTP Mobile wall-mounting bracket dimension drawing

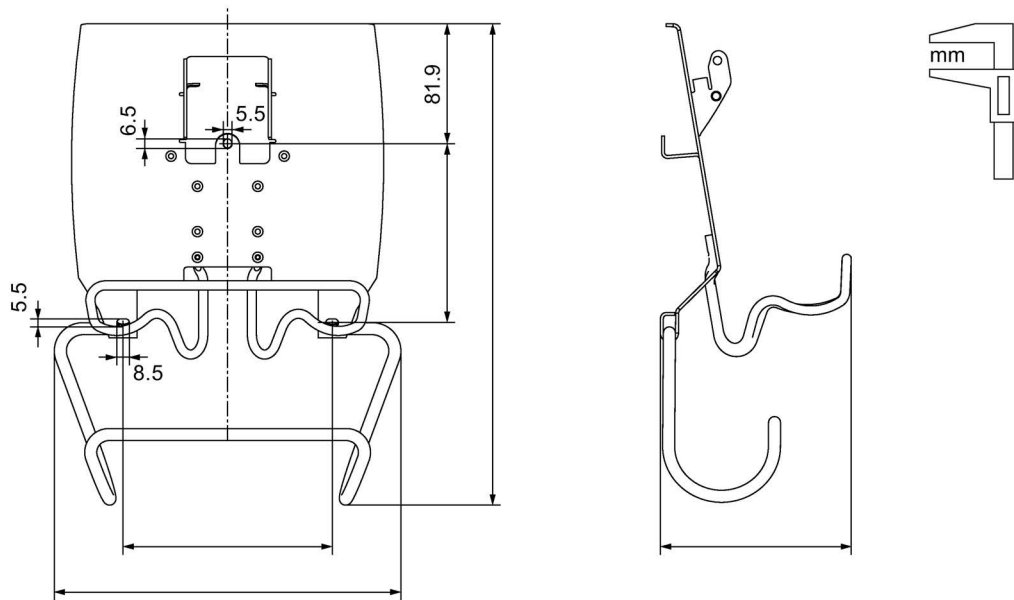

11.8 Technical specifications

11.8.1 Mobile Panel

Mechanics

	KTP400F Mobile	KTP700 Mobile	KTP700F Mobile	KTP900 Mobile	KTP900F Mobile
Weight without packaging	Approx. 900 g	Approx. 1200 g	Approx. 1300 g	Approx. 1500 g	Approx. 1600 g
Fall height	1.2 m				
Weight of the KTP Mobile wall-mounting bracket without packaging	Approx. 1000 g				

Display

	KTP400F Mobile	KTP700 Mobile KTP700F Mobile	KTP900 Mobile KTP900F Mobile
Type	LCD TFT		
Active display area	95 × 53 mm	154.1 × 85.9 mm	195 mm × 117 mm
Resolution	480 × 272 pixels	800 × 480 pixels, widescreen	
Color depth	16-bit, 24-bit		
Brightness control	By software		
Backlighting	LED		
Half Brightness Life Time (MTBF ¹)	≥ 50,000 h		
Pixel error class in accordance with EN ISO 9241-307	II		

¹ Operating hours after which the maximum brightness is reduced by half compared to the original value. MTBF is increased by using the integrated dimming function, for example, time-controlled via screen saver or centrally via PROFIenergy.

Input device

	KTP400F Mobile	KTP700 Mobile KTP700F Mobile	KTP900 Mobile KTP900F Mobile
Type	Touch screen, analog resistive		
Function keys	4	8	10
Labeling strips	No		

Memory

	KTP400F Mobile	KTP700 Mobile KTP700F Mobile	KTP900 Mobile KTP900F Mobile
Data memory	512 MB		
Program memory	1024 MB		

Interfaces

	KTP400F Mobile	KTP700 Mobile KTP700F Mobile	KTP900 Mobile KTP900F Mobile
1 × Ethernet RJ45	10/100 Mbps		
1 x USB 2.0	Type A, max. 500 mA		

Power supply, via connection box

	KTP400F Mobile	KTP700 Mobile KTP700F Mobile	KTP900 Mobile KTP900F Mobile
Rated voltage	+24 V DC		
Permitted voltage range	19.2 ... 28.8 V (24 V ± 20%)		
Transients, maximum permitted	35 V (500 ms)		
Time between two transients	≥ 50 s		
Current consumption, typical	Approx. 250 mA	Approx. 350 mA	Approx. 450 mA
Continuous current, maximum	Approx. 400 mA	Approx. 440 mA	Approx. 500 mA
Inrush current I _{2t}	Approx. 0.2 A ² s		
Fuse, internal	Electronic		
Bypass period after the HMI device has been disconnected from the connection box	None	5 minutes	
Charging time on the connection box until the bypass period is guaranteed	Not applicable	2 minutes	

Miscellaneous

	KTP400F Mobile	KTP700 Mobile KTP700F Mobile	KTP900 Mobile KTP900F Mobile
Real time clock, buffered, can be synchronized	Yes, typical buffer period 3 weeks		
Feedback, acoustic	No		

Insulation testing, protection class and degree of protection

Insulation testing

The insulation strength is demonstrated in the type test with the following test voltages in accordance with IEC 61131-2:

Circuit	Insulation tested with (type test)
Rated voltage U_e 24 V	707 V DC to other circuits / to ground
Ethernet connector	1500 V AC

Protection class

Protection class III according to IEC 61131-2

Protection against foreign objects and water

The device meets the degrees of protection to IEC 60529 and UL50 under the following requirements:

- The terminal compartment cover is closed.
- The USB port is closed using a cover.

Device side	Explanation
All-round	<ul style="list-style-type: none"> • IP65 according to IEC 60529 • Type 4X/Type 12 (indoor use only) to UL50 Applies if indicated on the nameplate

Degree of pollution and overvoltage category

The device meets the following requirements according to IEC 61131-2:2007.

Pollution level	2
Overvoltage category	II

11.8.2 Connecting cable

Weight	You can find the information based on length on the Internet at: HMI accessories (https://mall.industry.siemens.com/mall/en/WW/Catalog/Products/10144445) *
Bending radius, minimum	≥ 4-times the outside diameter of the line
Rated condition, temperature	0 to 55 °C

* To navigate directly to the information about the connecting cable, enter the article number of the connecting cable in the "Site Explorer" text box.

11.8.3 Connection boxes

Mechanics

Weight without packaging	Connection box compact	Approx. 250 g
	Connection box standard, connection box advanced	Approx. 750 g

Power supply

The information in the following table applies to the connection box compact, the connection box standard and the connection box advanced.

The information on the maximum permissible amperage for the acknowledgment button circuit also applies when using the connection box PN Basic or the connection box PN Plus.

Rated voltage	+24 V DC	
Permitted voltage range	19.2 ... 28.8 V (± 20 %)	
Transients, maximum permitted	35 V (500 ms)	
Time between two transients	≥ 50 s	
Enabling button ¹	Supply voltage	24 V DC
	Amperage, max. ²	300 mA
	Amperage, min.:	10 mA
Emergency stop/stop button ¹	Supply voltage	24 V DC
	Amperage, max.:	500 mA
	Amperage, min.:	10 mA
Cable length between connection box and PLC	≤ 30 m	
Fuse, internal	Electronic	
Current load PLC-accompanying signals	< 100 mA	
Recovery time	≥ 1 s	

¹ For fail-safe Mobile Panel

² Also applies when using the connection box PN Basic or the connection box PN Plus

Current consumption of the connection box compact

Current consumption without Mobile Panel	Typical	Approx. 20 mA
	Continuous current, maximum	Approx. 50 mA
	Inrush current I ² t	Approx. 0.1 A ² s
Current consumption with Mobile Panel	Typical	Approx. 550 mA
	Continuous current, maximum	Approx. 700 mA
	Inrush current I ² t	Approx. 0.6 A ² s

Current consumption of the connection box standard and connection box advanced

Current consumption without Mobile Panel	Typical	Approx. 100 mA
	Continuous current, maximum	Approx. 150 mA
	Inrush current I ² t	Approx. 0.5 A ² s
Current consumption with Mobile Panel	Typical	Approx. 600 mA
	Continuous current, maximum	Approx. 750 mA
	Inrush current I ² t	Approx. 0.6 A ² s

Internal switches of the connection box standard and connection box advanced

Industrial Ethernet switch of the connection box standard	Designation	SCALANCE XF208
	Article number	6GK5208-0BA00-2AF2

Industrial Ethernet switch of the connection box advanced	Designation	SCALANCE XF204 IRT
	Article number	6GK5204-0BA00-2BF2

A detailed description of the internal SCALANCE switches of both connection boxes is available in the following documents:

- Operating instructions "SCALANCE X-200"
(<https://support.industry.siemens.com/cs/ww/en/view/102051962>)
- Configuration manual "SCALANCE X-200"
(<https://support.industry.siemens.com/cs/ww/de/view/109476763>)

Insulation testing, protection class and degree of protection

Insulation testing

The insulation strength is demonstrated in the type test with the following test voltages in accordance with IEC 61131-2:

Circuit	Insulation tested with (type test)
Rated voltage U_e 24 V	707 V DC to other circuits / to ground
Ethernet connector	1500 V AC

Protection class

Protection class III according to IEC 61131-2

Protection against foreign objects and water

The device meets the following degrees of protection to IEC 60529 under the following requirements.

- Connection box compact: The connection box has been installed as described in this document.

Device side	Degree of protection
Front	When mounted: <ul style="list-style-type: none"> • IP65 according to IEC 60529 • Type 4X/Type 12 (indoor use only) to UL50 Applies if indicated on the nameplate
Rear	IP20 Protection against contact with standard test probes. There is no protection against the ingress of water, dust and noxious gas.

- Connection boxes standard and advanced: Any screw glands not used are fitted with a cover.

Device side	Explanation
All-round	<ul style="list-style-type: none"> • IP65 according to IEC 60529 • Type 4X/Type 12 (indoor use only) to UL50 Applies if indicated on the nameplate

11.8.4 Power consumption specifications

The connection box and Mobile Panel must be taken into consideration when calculating the power consumption. The tables below show typical values for the power consumption.

Note

The actual power consumption may vary depending on the configuration and the load at the interfaces of the Mobile Panel deviating from the specified values. The following factors affect the power consumption, for example:

- The display brightness set on the Mobile Panel
- The load on the USB interface of the Mobile Panel
- The length of the connecting cable

Connection box	Power consumption ¹
Connection box compact	0.5 W
Connection box standard	2.4 W
Connection box advanced	2.8 W

¹ The power loss generally corresponds to the specified value for power consumption.

Mobile Panel	Power consumption ¹
KTP400F Mobile	6 W
KTP700 Mobile	7 W
KTP700F Mobile	8 W
KTP900 Mobile	9 W
KTP900F Mobile	10 W

¹ The power loss generally corresponds to the specified value for power consumption.

The total power consumption for the HMI device is calculated as follows:

Total power consumption = power consumption connection box + power consumption Mobile Panel

11.8.5 Reaction times and safety characteristics for fail-safe operation

This section applies to fail-safe operation with fail-safe Mobile Panels.

Note

Proof-test intervals

Proof-test interval of the device (Lifetime): 20 years. The device must be replaced after this, at the latest.

Proof-test interval for safety-related operator controls dependent on the Safety Integrity Level SIL:

- SIL2: Function test 1 × per year
- SIL3: Function test 1 × per month

Reaction times

The table shows below the reaction times of the HMI device up to the output of the connection box, dependent on the F-system.

- For hardwired F-system: Reaction time of HMI device up to output or interface X10 of the connection box.
- For a PROFIsafe-based F-system: Reaction time of HMI device up to interface X1 of the connection box.

Operating mode		Stop/E-stop button evaluated by safety relay	E-stop button evaluated by PROFIsafe
Reaction time			
Emergency stop / stop button			
Reaction time during error-free operation	Press switch	< 10 ms	< 15 ms
	Unlock switch	< 10 ms	< 15 ms
Reaction time with error	Discrepancy detected (safe state)	See Safety relay	< 15 ms
	Critical internal error	< 30 ms	< 30 ms
Discrepancy time		See Safety relay	500 ms
Acknowledgment time in safety mode		-	< 15 ms
Enable			
Reaction time during error-free operation	No Enabling or Panic	< 15 ms	< 15 ms
	Enabling	< 40 ms	< 40 ms
Reaction time with error pending	Discrepancy detected (safe state)	< 15 ms	< 15 ms
	Critical internal error	< 30 ms	< 30 ms
Discrepancy time		500 ms	500 ms
Acknowledgment time in safety mode		-	< 15 ms

Note

Times

The specified times do not include the times of the applicable safety relay or the safety program (PROFIsafe), including the PNIO cycle time and F-monitoring time.

Use the following table for calculation of the total reaction time: S7Safety_RTTplus.xlsm (<https://support.industry.siemens.com/cs/#document/93839056?lc=en-US>)

Safety characteristics

Safety characteristics for Mobile Panels 2nd Generation and the associated connection boxes

- In accordance with IEC 61508

Maximal attainable safety integrity level	SIL2 (Proof Test Interval 1 year) SIL3 (Proof Test Interval 1 month)
Mode of operation	High and low demand mode
Hardware fault tolerance (HFT)	1
Classification	B
Repair Time	100 h
Probability of a dangerous failure per hour (PFHd)	$< 1 \times 10^{-8}$ 1/h
Probability of a dangerous failure on demand (PFDavg)	$< 8 \times 10^{-5}$
Mission Time	20 years

- In accordance with ISO 13849-1

Meantime to Failure (MTTFd)	High
Diagnostic Coverage (DCavg)	High
Performance Level	d (Proof Test Interval 1 year) e (Proof Test Interval 1 month)
Category	3 (Proof Test Interval 1 year) 4 (Proof Test Interval 1 month)

Safety characteristics (compatibility of Mobile Panels 2nd Generation with PN basic and PN plus connection boxes)

- In accordance with IEC 61508

Maximal attainable safety integrity level	SIL2 (Proof Test Interval 1 year)
Mode of operation	High and low demand mode
Hardware fault tolerance (HFT)	1
Classification	B
Repair Time	100 h
Probability of a dangerous failure per hour (PFHd)	$< 3 \times 10^{-8}$ 1/h
Probability of a dangerous failure on demand (PFDavg)	$< 2 \times 10^{-4}$
Mission Time	20 years

- In accordance with ISO 13849-1

Meantime to Failure (MTTFd)	High
Diagnostic Coverage (DCavg)	Medium
Performance Level	d
Category	3

Safety characteristics (compatibility of Mobile Panels 1st Generation with connection box compact, connection box standard and connection box advanced)

- In accordance with IEC 61508

Maximal attainable safety integrity level	SIL2 (Proof Test Interval 1 year)
Mode of operation	High and low demand mode
Hardware fault tolerance (HFT)	1
Classification	B
Repair Time	100 h
Probability of a dangerous failure per hour (PFHd)	$\leq 1,25 \times 10^{-7}$ 1/h
Probability of a dangerous failure on demand (PFDavg)	$< 6 \times 10^{-4}$
Mission Time	20 years

- In accordance with ISO 13849-1

Meantime to Failure (MTTFd)	High
Diagnostic Coverage (DCavg)	Medium
Performance Level	d
Category	3

The safety characteristics according to IEC 61508 and ISO 13849-1 in the table above are based on the SN 29500 and an ambient temperature of 60 °C.

11.8.6 Specification of cables to be used

Cables for 24 V DC and functional grounding		Connection box advanced	Connection box standard	Connection box compact
Connectable cable cross-sections for single-core/solid cables H05(07) V-U		0.5 ... 1.5 mm ² ; AWG 21 ... AWG 16		
Connectable cable cross-sections for flexible/stranded cables H05(07) V-K	Without ferrule	0.5 ... 1.5 mm ²		
	With ferrule according to DIN 46 228/1	AWG 21 ... AWG 16		
	With ferrule according to DIN 46 228/4	0.5 ... 1.5 mm ²		
Number of cables per connection		1		
Cable material		Copper (Cu)		
Stripped length of the cables		8 mm		
Connection technology		Push-in terminal		

Connections for emergency stop / stop button and enabling button		Connection box advanced	Connection box standard	Connection box compact
Connectable cable cross-sections for single-core/solid cables H05(07) V-U		0.2 ... 1.5 mm ² ; AWG 24 ... AWG 16		
Connectable cable cross-sections for flexible/stranded cables H05(07) V-K	Without ferrule	0.2 ... 1.5 mm ²		
	With ferrule according to DIN 46 228/1	AWG 24 ... AWG 16		
	With ferrule according to DIN 46 228/4	0.25 ... 1.5 mm ²		
Number of cables per connection		1		
Cable material		Copper (Cu)		
Stripped length of the cables		8 mm		
Connection technology		Push-in terminal		

Ethernet cables	Connection box advanced	Connection box standard	Connection box compact
Connectable cable	6XV1840-2AH10 or comparable		6XV1840-2AH10 or comparable, Industrial Ethernet FastConnect Cable 2x2 *
Connection technology	Fast connect		RJ45

* Available on the Internet at: Industrial Ethernet FastConnect Cable 2x2
<http://w3.siemens.com/mcms/industrial-communication/en/ie/Cabling-technology/fc-cable-2x2/Pages/fc-cable-2x2.aspx>

11.9 Interface description for Mobile Panel

11.9.1 Internal interface X1P1

PROFINET (LAN), RJ45 socket

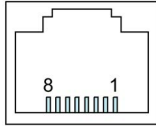

Pin	Name	Meaning
1	Tx+	Data output +
2	Tx-	Data output -
3	Rx+	Data input +
4	NC	Not assigned
5	NC	Not assigned
6	Rx-	Data input -
7	NC	Not assigned
8	NC	Not assigned

11.9.2 Internal interface X80

12-pin post connector

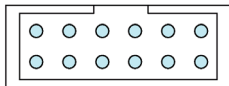

The post connector has connections for:

- Power supply
- STOP circle
- Enable circuit
- Signals for transmitting the box ID

11.9.3 External interface X61

USB Type A

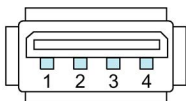

Pin	Name	Meaning
1	VBUS	+5 V, fused
2	D-	Data channel, bidirectional
3	D+	Data channel, bidirectional
4	GND	Ground

11.10 Connection box compact interfaces

11.10.1 Position of the interfaces

The figure below shows the interfaces of the connection box compact that are relevant for connecting the data and power supply cables.

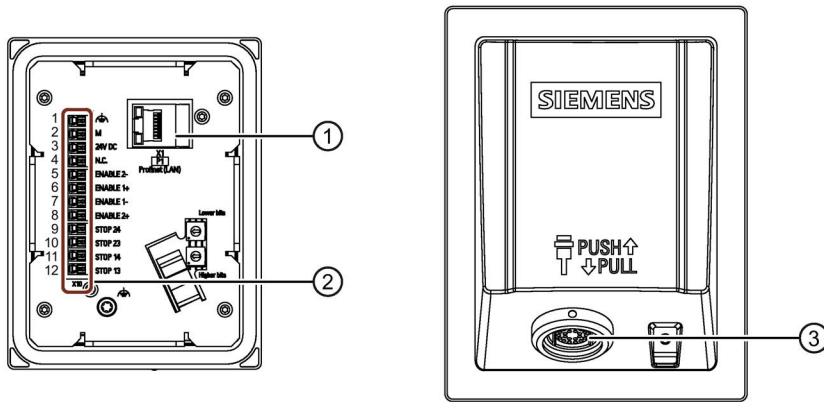

- ① Interface X1
- ② Interface X10

- ③ Connection socket (X300)

11.10.2 Interface X1

PROFINET (LAN), RJ45 socket

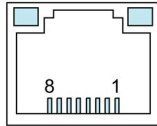

Pin	Name	Meaning
1	Tx+	Data output +
2	Tx-	Data output -
3	Rx+	Data input +
4	NC	Not assigned
5	NC	Not assigned
6	Rx-	Data input -
7	NC	Not assigned
8	NC	Not assigned

Note

LEDs on the RJ45 socket not active

The two LEDs at the RJ45 socket of the connection box compact are not supported by the hardware and do not light up during operation.

11.10.3 Plug-in terminal strip X10

Plug-in terminal strip, 12-pin

Contact	Assignment	Associated circuits and reference information
1	Functional grounding	Ground and power supply See "Connecting the functional grounding and power supply to the connection box (Page 64)."
2	M	
3	P24	
4	Not connected	
5	ENABLE2-	Enabling button See section "Operating the enabling button (Page 81)" and wiring information in the following section
6	ENABLE1+	
7	ENABLE1-	
8	ENABLE2+	
9	STOP 24	Emergency stop / stop button See section "Pressing the emergency stop / stop button (Page 83)" and wiring information in the following section
10	STOP 23	
11	STOP 14	
12	STOP 13	

11.10.4 Wiring of safety-related operator controls

Emergency stop/stop button

The figure below shows the wiring of the emergency stop/stop button in the connection box compact.

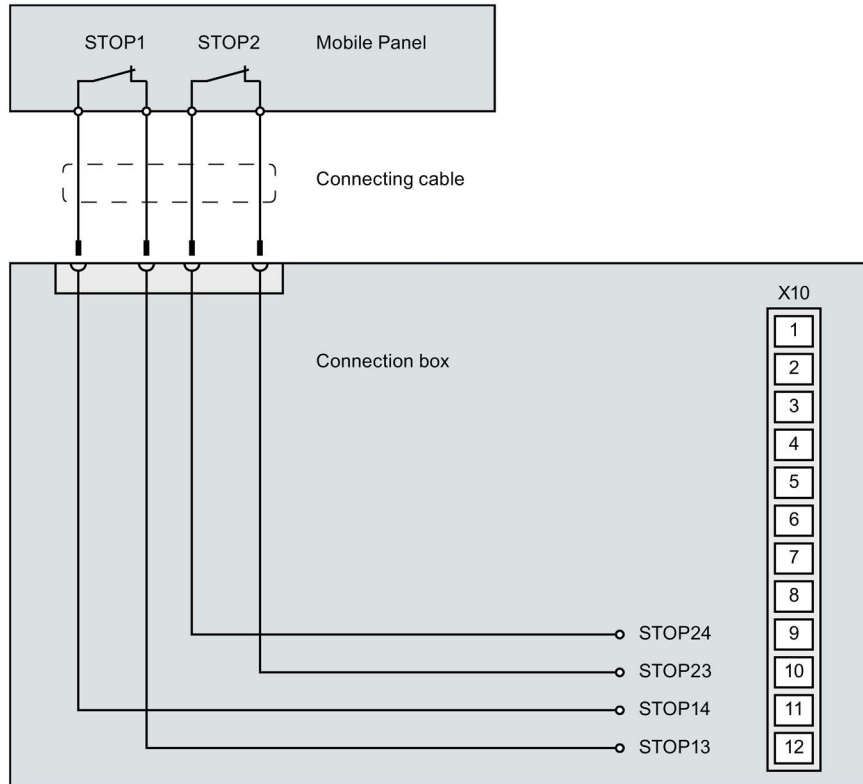

Enabling button

The figure below shows the wiring of the enabling button in the connection box compact.

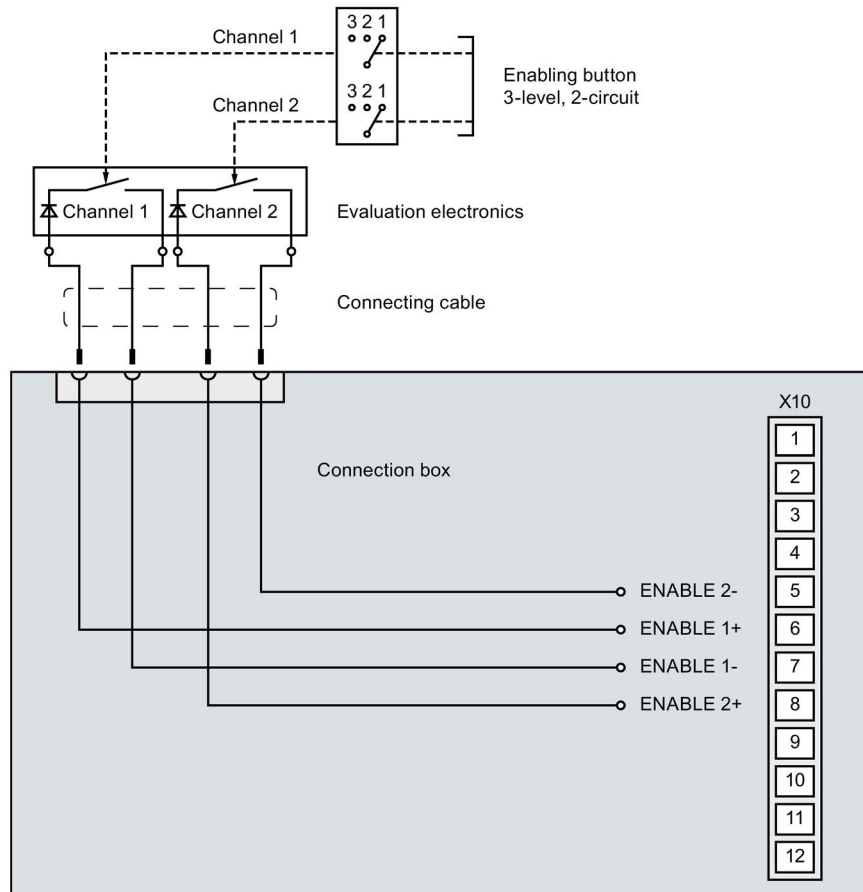

See also

FAQs Mobile Panels 2nd Generation

(<https://support.industry.siemens.com/cs/ww/en/ps/14746/faq>)

11.11 Interfaces of the connection box standard and connection box advanced

11.11.1 Position of the interfaces

The figure below shows the position of the interfaces in the connection box standard and in the connection box advanced that are relevant for connecting the data and power supply cables.

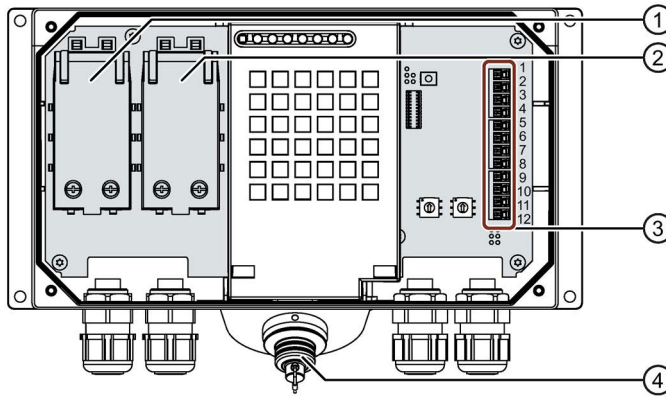

- ① Fast Connector X1
- ② Fast Connector X2
- ③ Interface X10
- ④ Connection socket (X300)

11.11.2 Fast connector X1 and X2

Fast Connector, 4-pin

The connection box contains two fast connectors for connecting the Ethernet data cables.

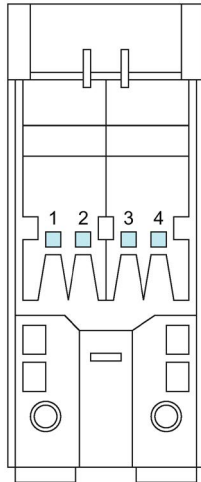

Contact	Color	Assignment in the connection box	Assignment in the PLC ¹
1	Yellow	RD+	TD+
2	White	TD+	RD+
3	Orange	RD-	TD-
4	Blue	TD-	RD-

¹ Only relevant if the PLC is connected directly to the connection box.

11.11.3 Plug-in terminal strip X10

Plug-in terminal strip, 12-pin

Contact	Assignment	Associated circuits and reference information
1	Functional grounding	Ground and power supply See "Connecting the functional grounding and power supply to the connection box (Page 64)."
2	M	
3	P24	
4	Not connected	
5	STOP 13	Emergency stop / stop button See section "Pressing the emergency stop / stop button (Page 83)" and wiring information in the following section
6	STOP 14	
7	STOP 23	
8	STOP 24	
9	ENABLE2+	Enabling button See section "Operating the enabling button (Page 81)" and wiring information in the following section
10	ENABLE1-	
11	ENABLE1+	
12	ENABLE2-	

11.11.4 Wiring of safety-related operator controls

Emergency stop/stop button

Connection box standard

The figure below shows the wiring of the emergency stop/stop button in the connection box standard.

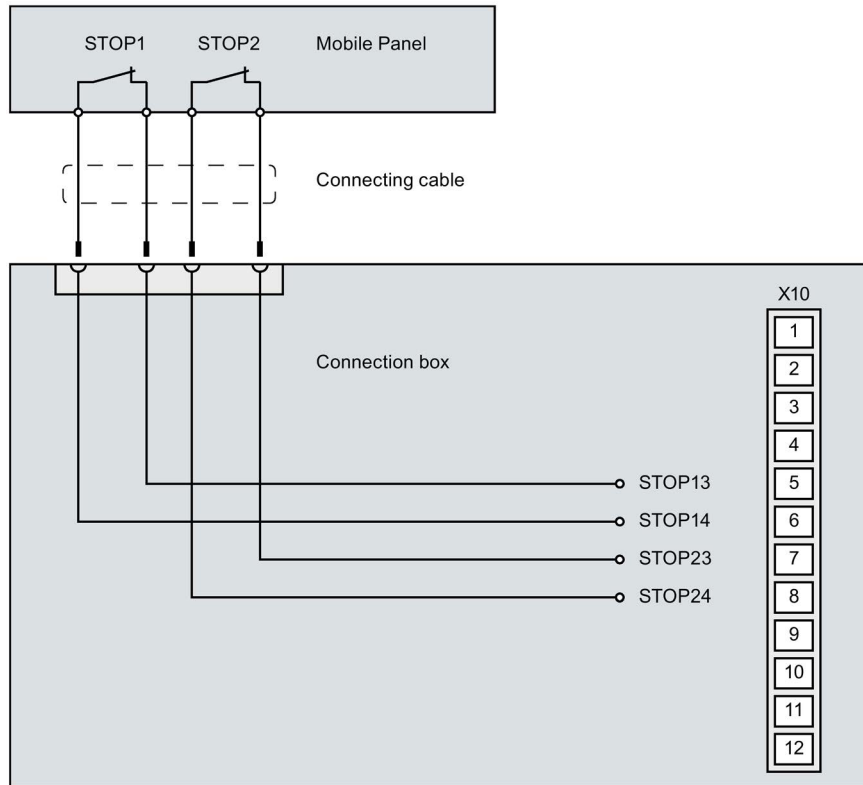

Connection box advanced

The figure below shows the wiring of the emergency stop/stop button in the connection box advanced.

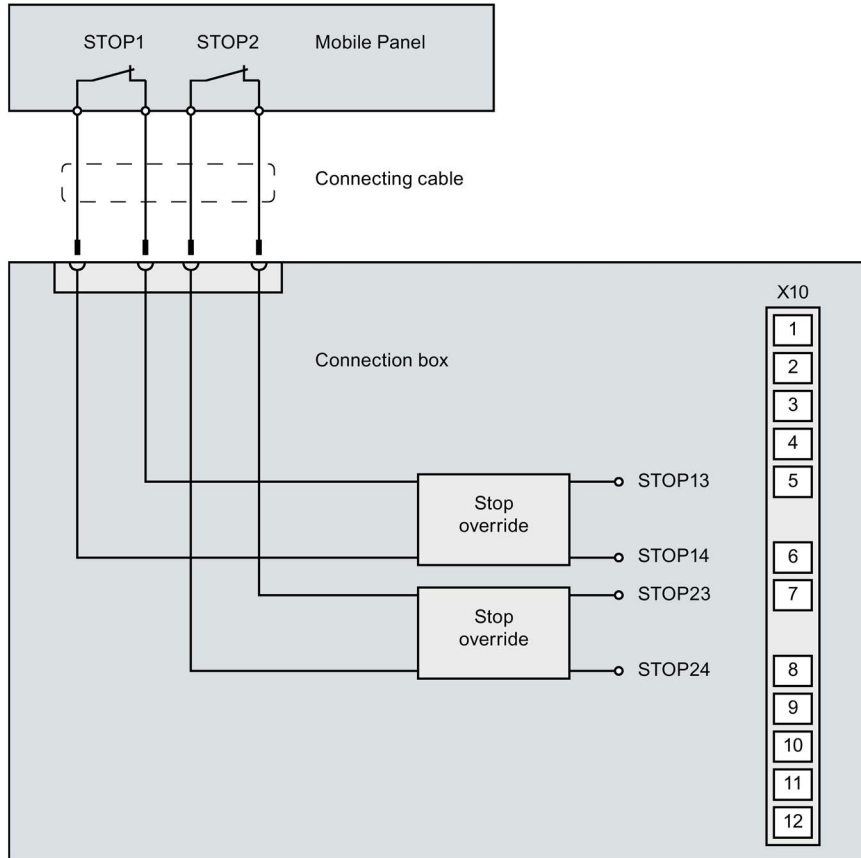

The stop bypass only works if the connection box is supplied with power.

Enabling button

The figure below shows the wiring of the enabling button in the connection box standard and in the connection box advanced.

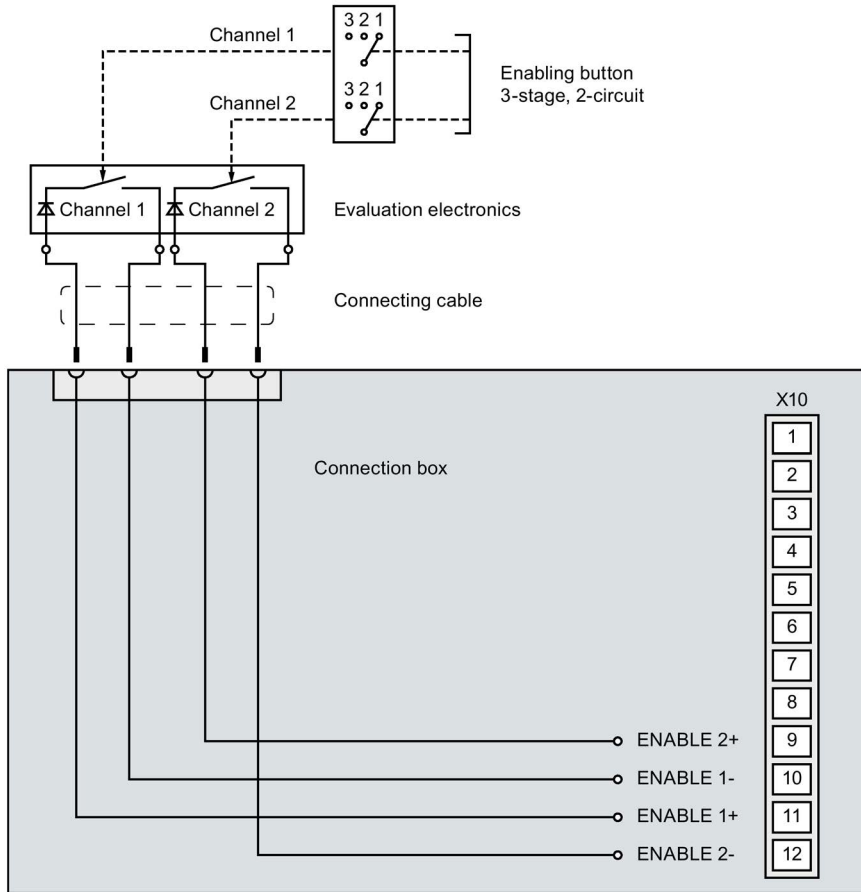

See also

FAQs Mobile Panels 2nd Generation
(<https://support.industry.siemens.com/cs/ww/en/ps/14746/faq>)

11.12 Communication with controllers

Number of connections

The table below shows the maximum number of controller connections for a Mobile Panel 2nd Generation.

Connection Type	Number of connections, via connection box
With bus connection	8
With "SIMATIC HMI HTTP protocol"	8

Compatible controllers

The table below shows the controllers that you can connect to the HMI device via the connection boxes.

PLC	Compatible with Mobile Panels 2nd Generation
SIMATIC S7-1500, SIMATIC S7-1500F	Yes
SIMATIC S7-400, SIMATIC S7-400F	Yes
SIMATIC S7-300, SIMATIC S7-300F	Yes
SIMATIC S7-1200, SIMATIC S7-1200F	Yes
SIMATIC S7-200	Yes
LOGO	Yes
SIMATIC HTTP Protocol	Yes
OPC/XML-DA-Server	No
OPC UA	Yes
Allen-Bradley EtherNet/IP	Yes
Allen-Bradley DF1	No
Mitsubishi MC TCP/IP	Yes
Mitsubishi FX	No
Modicon Modbus TCP/IP	Yes
Modicon Modbus RTU	No
Omron Hostlink	No

NOTICE

In PROFIsafe-based F-system only use S7-12xx CPUs with firmware version \geq 4.1.

When using a S7-12xx CPU with firmware version $<$ 4.1 in a PROFIsafe-based F-system, faults can occur in the PROFIsafe communication.

If you are using an S7-12xx CPU in a PROFIsafe-based F-system, this CPU must have a firmware version \geq 4.1.

11.13 Scope of functions with WinCC

Mobile Panel

The following tables of system limits help you assess whether your project conforms to the system limits of a given HMI device.

The specified maximum values are not additive. It cannot be guaranteed that configurations running on the devices at the full system limits will be functional.

In addition to the specified limits, allowances must be made for restrictions imposed by configuration memory resources.

Tags

	KTP400F Mobile	KTP700 Mobile / KTP700F Mobile KTP900 Mobile / KTP900F Mobile
Number of tags in the project		2048
Number of PowerTags		--
Number of elements per array		1000
Number of local tags		1000
Number of structures		999
Number of structure elements		400

Alarms

	KTP400F Mobile	KTP700 Mobile / KTP700F Mobile KTP900 Mobile / KTP900F Mobile
Number of alarm classes		32
Number of discrete alarms		4000
Number of analog alarms		200
Length of an alarm in characters		80
Number of process values per alarm		8
Size of the alarm buffer		1024
Number of queued alarm events		500

Screens

	KTP400F Mobile	KTP700 Mobile / KTP700F Mobile KTP900 Mobile / KTP900F Mobile
Number of screens	500	
Number of fields per screen	50	400
Number of tags per screen	50	400
Number of complex objects per screen ¹⁾	5	20

¹⁾ Complex objects include: Bars, sliders, symbol library, clock, and all objects from the Controls area.

Recipes

	KTP400F Mobile	KTP700 Mobile / KTP700F Mobile KTP900 Mobile / KTP900F Mobile
Number of recipes	300	
Number of elements per recipe ¹⁾	1000	
User data length in bytes per data record	256 KB	
Number of data records per recipe	500	
Reserved memory for data records in the internal Flash	2 MB	

¹⁾ Each array element used in arrays represents a recipe element

Logs

	KTP400F Mobile	KTP700 Mobile / KTP700F Mobile KTP900 Mobile / KTP900F Mobile
Number of logs	50	
Number of entries per log (including all log segments) ¹⁾	20000	
Number of sequential logs	400	
Cyclic trigger for tag logging	1 s	
Number of tags that can be logged per log	2048	

¹⁾ The number of entries for all segmented circular logs is valid for the "segmented circular log" logging method. The product of the number of sequential logs and the number of data records per sequential log may not exceed the system limit

Trends

	KTP400F Mobile	KTP700 Mobile / KTP700F Mobile KTP900 Mobile / KTP900F Mobile
Number of trends		300
Number of trends per trend view		8

Text lists and graphics lists

	KTP400F Mobile	KTP700 Mobile / KTP700F Mobile KTP900 Mobile / KTP900F Mobile
Number of graphics lists		500
Number of text lists		500
Number of entries per text or graphics list		500
Number of graphic objects		4000
Number of text elements		40000

Scripts

	KTP400F Mobile	KTP700 Mobile / KTP700F Mobile KTP900 Mobile / KTP900F Mobile
Number of scripts		100

Communication

	KTP400F Mobile	KTP700 Mobile / KTP700F Mobile KTP900 Mobile / KTP900F Mobile
Number of connections		8
Number of connections based on "SIMATIC HMI HTTP"		8
Maximum number of connected Sm@rtClients (including a service client)		3

Plants areas

	KTP400F Mobile	KTP700 Mobile / KTP700F Mobile KTP900 Mobile / KTP900F Mobile
Number of zones		254

Help system

	KTP400F Mobile	KTP700 Mobile / KTP700F Mobile KTP900 Mobile / KTP900F Mobile
Number of characters in a help text		500

Languages

	KTP400F Mobile	KTP700 Mobile / KTP700F Mobile KTP900 Mobile / KTP900F Mobile
Number of runtime languages		32

Scheduler

	KTP400F Mobile	KTP700 Mobile / KTP700F Mobile KTP900 Mobile / KTP900F Mobile
Time-triggered tasks ¹		48

¹ Event-triggered tasks are not relevant for the system limits

User administration

	KTP400F Mobile	KTP700 Mobile / KTP700F Mobile KTP900 Mobile / KTP900F Mobile
Number of user groups		50
Number of authorizations		32
Number of users		50

Project

	KTP400F Mobile	KTP700 Mobile / KTP700F Mobile KTP900 Mobile / KTP900F Mobile
Size of the project file ".fwx"/".srt"	4 MB	12 MB
Memory for options ¹	4 MB	12 MB

¹ The following options are not assigned to the option memory: Sm@rt options, WinAC, IE, ProAgent

11.14 Mobile Panel 2nd Generation F-FBs

11.14.1 Using F-FBs

Required F FBs

You must integrate the following fail-safe blocks in your safety program:

- For each HMI device: a FB198: F_FB_KTP_Mobile
The assigned HMI device is monitored by this F FB.
- For each connection box: a FB199: F_FB_KTP_RNG
The F_FB_KTP_RNG supplies the safety-related signals for the machine part that is assigned to a connection box.
- FB 215: ESTOP1; with this block, you can ensure that the operator must first provide confirmation after an emergency stop before the plant can be restarted. You can find this block in the following block container of the "Safety Advanced" F-library:
"Communication > Fail-safe HMI Mobile Panels > -- KTP Mobile --"

NOTICE

Naming conventions for F-application blocks

Ensure the following parameters match when changing the names of an F-application block:

- The symbolic name in the symbol table
- The name in the object properties of the block (header)

Rules for the safety program

WARNING

Emergency stop button not evaluated

The emergency stop button can only be evaluated in the following cases:

- System with emergency stop function, without enabling function: The output GLOBAL_E_STOP of F_FB_KTP_Mobile is used in the safety program.
- System with acknowledgment and emergency stop function: F_FB_KTP_RNG is evaluated by the safety program.

In a system with an emergency stop function, use the output GLOBAL_E_STOP of F_FB_KTP_Mobile in your safety program.

In a system with an acknowledgment and an emergency stop function, use F_FB_KTP_RNG in your safety program.

 WARNING
Prohibited restart of the plant
Once the emergency stop button has been triggered, the plant can only be restarted after operator acknowledgment. Use the FB 215 ESTOP1 in your safety program to ensure acknowledgment by the operator.

 WARNING
Emergency stop button is evaluated with delayed
If the cycle time for the OB 35 block (in conjunction with controllers of the type S7-300/400) or MAIN_SAFETY (in conjunction with controllers of the type S7-1500) is set too high, this can cause loss of frames and delayed evaluation of the output "E-STOP" of F_FB_RNG_n. Set the cycle time lower than that for the PROFINET IO time.

The F FBs used are called cyclically and in a specific order in the safety program. You need to call the F FBs in the following order in your safety program:

1. All F_FB_KTP_Mobile
2. All F_FB_KTP_RNG

The operator must always acknowledge errors, such as communication errors. You cannot use any automatic acknowledgment in your safety program, therefore.

Interconnection of the F FBs

 WARNING
Direct evaluation of the process images not allowed
You cannot directly evaluate the PII and PIQ in your program.

F I/O DB

An F I/O DB is automatically generated in HW Config for every F I/O.

The access to the F I/O and working with the F I/O DB is described in detail in the manual "SIMATIC Safety - Configuration and Programming (<http://support.automation.siemens.com/WW/view/en/54110126>)", "F I/O Access" section.

Application example

You can find a Getting Started and a detailed application example including TIA Portal project on the Internet (<https://support.industry.siemens.com/cs/ww/en/view/103497649>).

11.14.2 F_FB_KTP_Mobile

Inputs

Parameter	Data type	Description	Interconnection
QBAD	Bool	QBAD indicates whether there is an F-I/O communication fault.	F-I/O DB: DBx2.1 = QBAD
ACK_REQ	Bool	Acknowledgement required After a communication error, the fail-safe system sets QBAD = 1 and ACK_REQ = 0. ACK_REQ = 1 indicates that the PROFIsafe message frames are being exchanged again.	F-I/O DB: DBx2.2 = ACK_REQ
RESET	Bool	This input resets the status of the F_FB_KTP_Mobile to its "original state". The input is only evaluated if Q_BAD = 1. Setting the input RESET is necessary if the HMI device cannot return itself to a defined state, for example when an internal error occurs. This input responds to a rising edge.	Must be specifically interconnected for plant. The safety program must ensure that automatic restart of the plant is not possible after RESET is set. The operator must strictly ensure that he executes a separate operator action to commence the restart.
ACK_ERR	Bool	Communication errors may not be acknowledged automatically. This input is set to have the F-CPU to acknowledge a communication error during ongoing PROFIsafe communication. This input responds to a rising edge.	Must be specifically interconnected for plant.
MP_DATA	Int	User data of the F-process image input	PII: Int 1 = MP_DATA

Outputs

Parameter	Data type	Description	Interconnection
ACK_REI	Bool	Acknowledgement for reintegration The automatic reintegration is regulated via the F-I/O DB through this output.	F-I/O DB: DBx0.2 = ACK_REI
GLOBAL_E_STOP	Bool	This output returns device-specific emergency stop information.	
MP_E_STOP	Word	This output returns the effective-range-specific emergency stop information for the F_FB_KTP_RNG.	
MP_ENABLE	Word	This output returns the effective-range-specific "Acknowledgment" information for the F_FB_KTP_RNG.	
MP_DATA_Q	Int	User data of the fail-safe process image's inputs:	PIO: Int 1 = MP_DATA
DIAG	Word	Information about any occurring errors is provided through this output for servicing purposes. The value has the following meaning: 0x0001: HMI removed 0x0002: HMI device integrated; emergency stop and acknowledgment button are available. 0x0004: Communication error occurred, emergency stop activated, enabling button deactivated 0x0008: Communication error must be acknowledged. Emergency stop is enabled; acknowledgement button is disabled. 0x0010: HMI device removed, integration is being prepared. All other values: Reserved	You can evaluate the DIAG output in your program.

Enable inputs EN and ENO

When you call a fail-safe block, the enable input EN and enable output ENO appear automatically.

Note the following:

- Do not connect these I/Os
- Do not supply these I/Os with "0"
- Do not evaluate these I/Os

Wiring

You have to wire the inputs and outputs of the F-FB manually. No automatic wiring is performed.

Purpose

The assigned HMI device is monitored with the F_FB_KTP_Mobile.

You need to use a separate F_FB_KTP_Mobile for each HMI device.

F_FB_KTP_Mobile performs the following tasks:

- The block integrates the HMI device in the safety program of the F-CPU after startup.
- The block removes the HMI device from the safety program after a communication error. As soon as the communication error has been corrected and the operator has acknowledged this, the block integrates the HMI device back into the safety program.

- The block sends the states of the HMI device to F_FB_KTP_RNG_n.

The following HMI device states are possible:

- "Removed"
- "Integrated"
- "Communication error"
- "Communication error, acknowledgement required"

QBAD monitors the output of the F-I/O for integrating and removing the HMI device.

- QBAD = 0: PROFIsafe communication is taking place between the HMI device and the F-CPU.
- QBAD = 1: No PROFIsafe communication is not taking place between the HMI device and the F-CPU.

WARNING

Inadmissible automatic restart of the plant

The safety program must ensure that automatic restart of the plant is not possible after RESET is set. The operator must strictly ensure that he executes a separate operator action to commence the restart.

Addresses of PII and PIQ

You can find the start addresses of PII and PIQ in the PROFIsafe settings of the HMI device in HW Config.

11.14.3 F_FB_KTP_RNG

Inputs

Parameter	Data type	Description	Interconnection
ID	Word	The connection box is uniquely identified by the ID set on the connection box. The ID must be unique throughout the plant and must match the value of this parameter. The value has the following meaning: 0 or > 254: Invalid box ID, emergency stop and acknowledgment button are disabled. 1...254: Valid box ID, emergency stop and acknowledgment button enabled depending on the mode of the HMI device.	---
E_STOP_EXT	Bool	External information on the state of the emergency stop button of another F_FB_KTP_RNG with cascading.	
ENABLE_EXT	Bool	External information on the state of the acknowledgement button of another F_FB_KTP_RNG with cascading.	
ACTIVATE_ENABLE	Bool	This input allows the acknowledgement button to be enabled and disabled.	
MP1_E_STOP	Word	Information from the F_FB_KTP_Mobile on the state of the emergency stop button of HMI device 1	
MP1_ENABLE	Word	Information from the F_FB_KTP_Mobile on the state of the acknowledgment button of HMI device 1	
MP2_E_STOP	Word	Information from the F_FB_KTP_Mobile on the state of the emergency stop button of HMI device 2	
MP2_ENABLE	Word	Information from the F_FB_KTP_Mobile on the state of the acknowledgment button of HMI device 2	

Outputs

Parameter	Data type	Description	Interconnection
E_STOP	Bool	This output is used to detect whether the emergency stop button on an HMI device connected to the F_FB_KTP_RNG is pressed. 0 = at least one emergency stop pressed, 1 = no emergency stop pressed	
ENABLE	Bool	This output is used to detect whether the acknowledgment button on an HMI device connected to the F_FB_KTP_RNG is pressed. 0 = at least once acknowledgement button pressed, 1 = no acknowledgement button pressed	You can detect if the enabling button has been pressed with this output.

Enable inputs EN and ENO

When you call a fail-safe block, the enable input EN and enable output ENO appear automatically.

Note the following:

- Do not connect these I/Os.
- Do not set "0" for these I/Os.
- Do not evaluate these I/Os.

Wiring

You have to wire the inputs and outputs of the F-FB manually. No automatic wiring is performed.

Purpose

In an F-system with enabling function and emergency stop function, you need an F_FB_KTP_RNG for each connection box.

Operating principle

Depending on the state of the HMI device connected to the connection box, the F-FB switches the outputs of the F_FB_KTP_RNG and prepares the output user data.

Each HMI device can take one of the following states on the connection box:

- Logged off without communication error
The HMI device is successfully removed from the safety program of the F-CPU. This ends PROFIsafe communication. The HMI device has no influence on the outputs of F_FB_KTP_RNG.
- Logged off without communication error
The actual operating mode of the HMI device on the connection box. F_FB_KTP_RNG responds as follows:
 - The HMI device is supplied with user data, for example the ID of the connection box.
 - The output ENABLE is set according to the state of the acknowledgement button of the HMI device.

The output E_STOP is set according to the state of the emergency stop button of the HMI device.
 - If the operator wishes to disconnect the HMI device from the connection box, he must log off the HMI device before disconnecting it from the safety program.
- Logged on with communication error
PROFIsafe communication with the HMI device is resumed after a brief interruption, enabling user data to be exchanged again between the HMI device and F CPU. As long as the communication error is not acknowledged, F_FB_KTP_RNG behaves as follows:
 - The HMI device is supplied with user data, for example the ID of the connection box.
 - The outputs E_STOP and ENABLE return the value "0" regardless of the switch position of the emergency stop button and the acknowledgment button.

Addresses of PII and PIQ

You can find the start address of the PII and PIQ in the PROFIsafe settings for the HMI device.

Cascading

In order to use more than two HMI devices on a connection box, you can cascade multiple F_FB_KTP_RNG blocks. Cascading F_FB_KTP_RNG works with the same ID. The following figure shows an example of the cascade structure of the multiple F_FB_KTP_RNG.

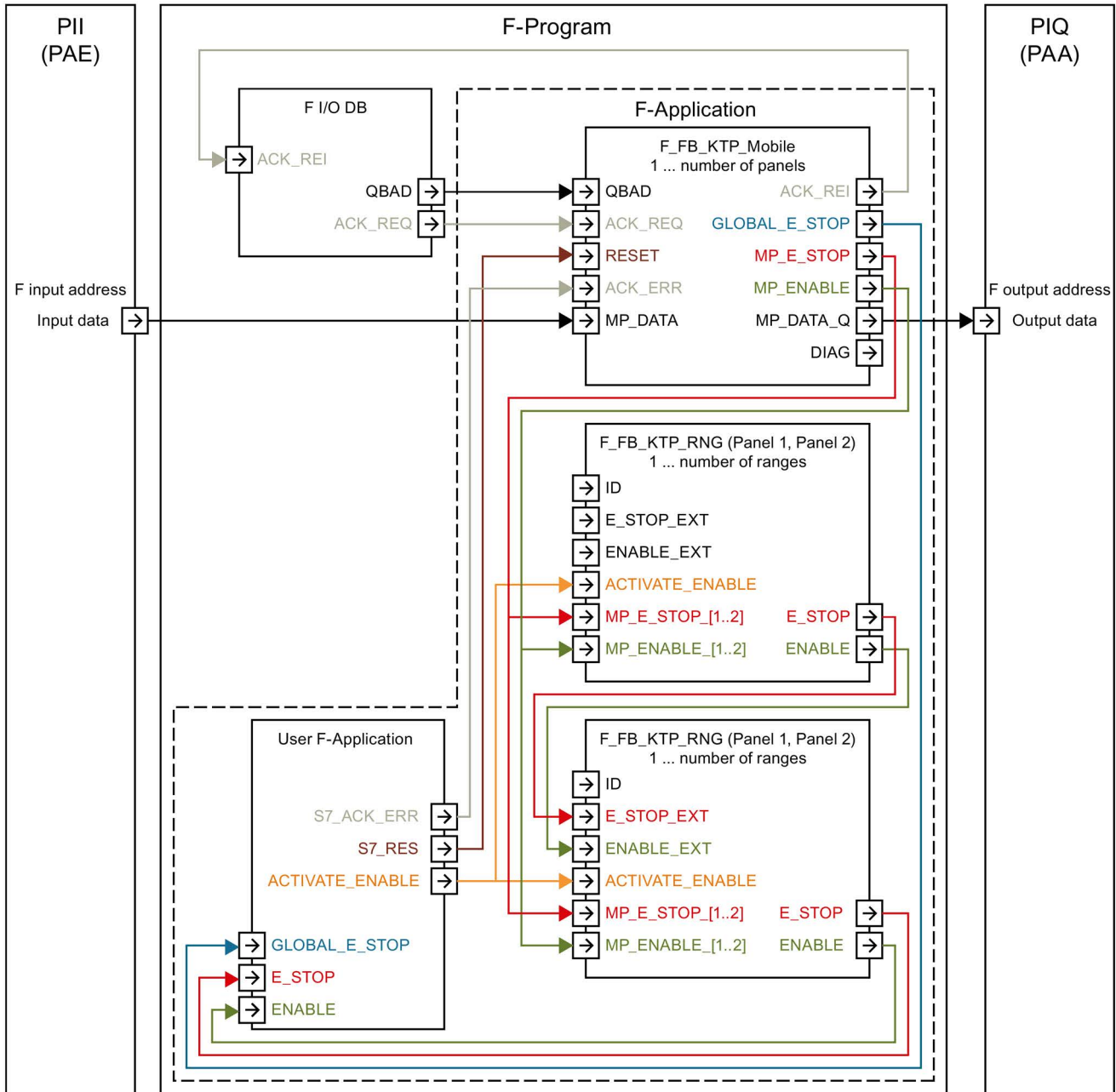

A.1 Troubleshooting

During fail-safe operation, you must be aware that the following error cases may arise:

- HMI does not start
If the HMI device does not start, the wires at interface X10 in the connection box may have been crossed. Check the connected wires and change the connections if necessary.
- Internal error
If an internal error occurs in the HMI device, the HMI device displays the "Fatal Error" message. Safety functions are no longer available. If the error persists after resetting the fail-safe module, contact the Siemens hotline. You can find additional information in the following section: "Fatal Error" dialog (Page 213)
- Communication error
If a PROFIsafe communication error occurs on the HMI device, the safety functions are not available. The F-CPU triggers an emergency stop and switches the plant or plant area into a defined safe operating state. When PROFIsafe communication is possible again, the message "Confirm communication error" is displayed. Confirm the message with the enabling button. You can find additional information in the following section: "Confirm communication error" dialog (Page 213)
- SCALANCE firmware error in the connection box
If a SCALANCE firmware error occurs in the standard or advanced connection box, press the SET button shown in the figure below for at least 15 seconds.

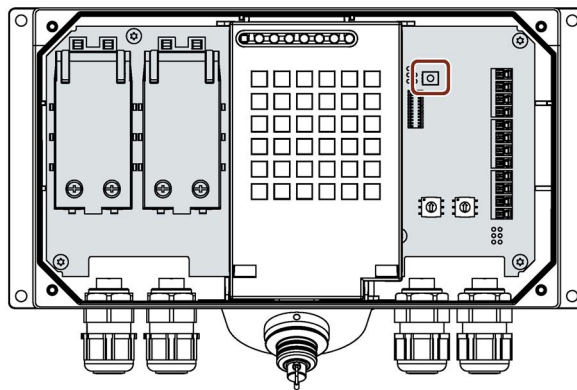

The SET button resets the firmware of the internal SCALANCE switch to the factory settings.

Note

The setting for safety-related operating mode of the connection box is retained.

You can find additional information about the SET button in the following document:
Operating instructions "SCALANCE X-200"

<https://support.industry.siemens.com/cs/ww/en/view/102051962>

A.2 Service and support

You can find additional information and support for the products described on the Internet at the following addresses:

- Technical support (<https://support.industry.siemens.com/cs/ww/en/>)
- Support request form (<http://www.siemens.com/automation/support-request>)
- After Sales Information System SIMATIC IPC/PG (<http://www.siemens.com/asis>)
- SIMATIC Documentation Collection (<http://www.siemens.com/simatic-tech-doku-portal>)
- Your local representative
(<http://www.automation.siemens.com/mcms/aspa-db/en/Pages/default.aspx>)
- Training center (<http://sitrain.automation.siemens.com/sitrainworld/?AppLang=en>)
- Industry Mall (<https://mall.industry.siemens.com>)
- TIA Selection Tool (<http://w3.siemens.com/mcms/topics/en/simatic/tia-selection-tool>)

When contacting your local representative or Technical Support, please have the following information at hand:

- MLFB of the device
- BIOS version for industrial PC or image version of the device
- Other installed hardware
- Other installed software

Current documentation

Always use the current documentation available for your product. You can find the latest edition of this manual and other important documents by entering the article number of your device on the Internet (<https://support.industry.siemens.com/cs/ww/en/>). If necessary, filter the comments for the entry type "Manual".

Tools & downloads

Please check regularly if updates and hotfixes are available for download to your device. The download area is available on the Internet at the following link:

After Sales Information System SIMATIC IPC/PG (<http://www.siemens.com/asis>)

See also

Displaying information about the Mobile Panel (Page 118)

Display firmware (Page 118)

A.3 Parameterization of the connection box standard and connection box advanced

The connection box standard and the connection box advanced have an internal SCALANCE switch. You parameterize the two connection boxes using the "Web Based Management" WBM of the respective SCALANCE switch as described in the following document:

Configuration manual "SCALANCE X-200"

(<https://support.industry.siemens.com/cs/ww/de/view/109476763>)

The description in the manual includes the following topics, among others:

- WBM login, that is login for parameter assignment of the connection box
- Firmware update
- Diagnostics
- Additional configuration options

A.4 System events

System events on the HMI device provide information about internal states of the HMI device and the controller.

Note

System events are only indicated if an alarm window was configured. System events are output in the language currently set on your HMI device.

System event parameters

System events may contain encrypted parameters which are relevant to troubleshooting because they provide a reference to the source code of the runtime software. Encrypted parameters are output after "Error code:".











Description of the system events

A list of system events and their description is available in the information system of the TIA Portal.

Markings and symbols





B.1 Safety-relevant symbols

The following table describes symbols that can be added to your SIMATIC device, to its packaging or to an enclosed document in addition to the symbols described in the manuals.

Symbol	Meaning	Reference
	General danger sign Caution / Attention You must following the operating instructions. The operating instructions contain information on the type of the potential hazard and enable you to identify risks and implement countermeasures.	ISO 7000 No. 0434B, DIN ISO 7000 No. 0434B
	Attention, only relevant for modules with Ex approval	
	Follow the instructions	ISO 7010 M002
	May be installed by qualified electricians only	IEC 60417 No. 6182
 F<2N DISPLAY F<4N HOUSING	Mechanical load for HMI devices	
 CABLE SPEC.	Connection cables must be designed for the ambient temperature	
 EMC	EMC-compliant installation	
 U = 0V	No mounting or pulling & plugging under voltage	
 230V MODULES	Dangerous electrical voltage for 230V modules	ANSI Z535.2
 24V MODULES	Protection class III, supply only with protective low voltage (SELV/PELV)	IEC 60417-1-5180 "Class III equipment"

Markings and symbols

B.1 Safety-relevant symbols

Symbol	Meaning	Reference
 <p>INDOOR USE ONLY INDUSTRIAL USE ONLY</p>	Only for industrial applications and indoor areas (control cabinet)	
	Install in control cabinet only	
 <p>ZONE 2 INSIDE CABINET IP54 EN60079-15</p>	Devices approved for Ex Zone 2 in a control cabinet with min. IP54	
 <p>ZONE 22 INSIDE CABINET IP6x EN60079-31</p>	Devices approved for Ex Zone 22 in a control cabinet with min. IP6x	

List of abbreviations

AS	Australia Standard
AWG	American Wire Gauge
CPU	Central Processing Unit
CSA	Canadian Standards Association
DB	Data block
DC	Direct Current
DHCP	Dynamic Host Configuration Protocol
DNS	Domain Name System
DP	Distributed I/O
DVD	Digital Versatile Disk
I/O	Input and Output
EAC	Eurasian Conformity
EC	European Community
ESD	Electrostatically sensitive devices
EMC	Electromagnetic compatibility
EN	European standard
ES	Engineering System
FCC	Federal Communications Commission
F_FB or F-FB	Fail-safe function block
GND	Ground
HF	High Frequency
Hardware	Hardware
HMI	Human Machine Interface
ID	Identification
IEC	International Electronic Commission
IEEE	Institute of Electrical and Electronics Engineers
IP	Internet Protocol
ISO	International Standard Organization
KTP	Key Touch Panel
LAN	Local Area Network
LED	Light Emitting Diode
MAC	Media Access Control
MTBF	Mean Time Between Failures
NTP	Network Time Protocol
NZS	New Zealand Standard
OB	Organization block

OP	Operator Panel
PC	Personal Computer
PG	Programming device
PELV	Protective Extra Low Voltage
RAM	Random Access Memory
RJ45	Registered Jack Type 45
SD	Secure Digital
SELV	Safety Extra Low Voltage
SMTP	Simple Mail Transfer Protocol
SP	Service Packet
SSL	Secure Socket Layer
STEP 7	Simple programming of controllers
TAB	Tabulator
TCP/IP	Transmission Control Protocol/Internet Protocol
Telnet	Telecommunication Network
TFT	Thin Film Transistor
TIA	Totally Integrated Automation
TLS	Transport Layer Security
UL	Underwriter's Laboratory
USB	Universal Serial Bus
VDE	Verband Deutscher Elektrotechniker
WBM	Web Based Management
WINS	Windows Internet Naming Service

Glossary

"Automatic mode" and "setup mode"

Program-controlled plants pose a significant safety risk for operators. EN 12417 "Machine tools. Safety. Machining centers" and DIN EN 13128 " Safety of machine tools - Milling and boring machines" define operating modes to ensure staff safety. A "setup mode" is required for correct plant setup for "automatic mode". Plant functions in this mode are limited compared to automatic mode. Devices have to be moved with the handwheel or in jog mode.

"Offline" operating mode

In this operating mode, the HMI device and the PLC do not communicate over the connections configured in the project. You can operate the current project on the HMI device. However, project data are not transferred.

"Online" operating mode

In this mode, the HMI device and PLC communicate. You can operate the plant with the HMI device in accordance with the configuration.

"Transfer" mode

In this mode, you can transfer a project from the configuration PC to the HMI device or backup and restore HMI device data, for example.

Acknowledge

Acknowledgment of an alarm confirms that it has been noted.

Automation system

An automation system is a controller of the SIMATIC S7 series, such as a SIMATIC S7-300.

Backtransfer

Backtransfer is the backup of a project from the HMI device to a configuration PC.

Bootloader

The bootloader is used to start the operating system and is started automatically after HMI device power on. The Start Center opens after the operating system has loaded.

Configuration PC

A configuration PC is a programming device or PC on which configuration software is installed. You can create projects for a plant with the configuration software.

Configuration software

Configuration software is software used to create projects for process visualization and input of process values. The SIMATIC TIA Portal is configuration software.

EMC

Electromagnetic compatibility is the ability of electrical equipment to function properly in its electromagnetic environment without influencing this environment.

Event

Functions are triggered by defined incoming events. Events can be configured. Events which can be assigned to a button include "Press" and "Release", for example.

Field array

Area reserved in configured screens for the input and output of values.

Flash memory

Non-volatile memory with EEPROM chips, used as mobile storage medium or as memory module installed permanently on the motherboard.

HMI device

An HMI device is a device used for the operation and monitoring of machines and plants. The statuses of the machine or plant are indicated by means of graphic elements or by indicator lamps on the HMI device. The operator controls of the HMI device allow the operator to interact with the processes of the machine or plant.

HMI device image

A file that can be transferred from the configuration PC to the HMI device. The HMI device image contains the operating system and elements of the runtime software required to run a project.

I/O field

An I/O field enables the input or output of values on the HMI device which are transferred to the PLC.

Infotext

An infotext is a configured information on objects within a project. Infotext for an alarm, for example, may contain information on the cause of the fault and troubleshooting routines.

Object

An object is a component of a project. Example: screen or alarm. Objects are used to view or enter texts and values on the HMI device.

Operating element

Component of a project used to enter values and trigger functions. A button, for example, is an operating element.

Plant

General term referring to machines, processing centers, systems, plants and processes which are operated and monitored on an HMI device.

PLC

A PLC is a general term for devices and systems with which the HMI device communicates, e.g. SIMATIC S7.

PLC job

A PLC job triggers a function for the PLC at the HMI device.

PROFINET

Within the framework of Totally Integrated Automation, PROFINET represents the systematic further development of the following bus systems:

- PROFIBUS DP as well-established fieldbus
- Industrial Ethernet as the communications bus for the cell level

The experience gained from both systems has been and continues to be integrated in PROFINET. PROFINET is an Ethernet-based automation standard from PROFIBUS International and defines a vendor-neutral communication and engineering model.

PROFINET IO

As part of PROFINET, PROFINET IO is a communication concept that is used to implement modular, distributed applications. PROFINET IO allows you to create automation solutions of the type with which you are familiar from PROFIBUS. PROFINET IO is implemented by the PROFINET standard for automation devices on the one hand, and on the other hand by the STEP 7 engineering tool.

This means that you have the same application view in STEP 7 regardless of whether you configure PROFINET devices or PROFIBUS devices. Programming your user program is essentially the same for PROFINET IO and PROFIBUS DP if you use the expanded blocks and system status lists for PROFINET IO.

Project

A project is the result of a configuration using configuration software. The project normally contains several screens with embedded system-specific objects, basic settings and alarms. The project file of a project that was created in WinCC is saved with the file name extension `"*.HMI"`.

You need to distinguish between a project on the configuration PC and an executable project on an HMI device. A project may be available in more languages on the configuration PC than can be managed on the HMI device. The project on the configuration PC can also be set up for different HMI devices. Only the runtime project that has been generated for the respective HMI device can be transferred to it.

Project file

A project file is a file from which the executable project file for use on the HMI device is generated. The project file is usually not transferred and remains on the configuration PC. The file extension of a project file is `"*.hmi"`.

Proof-test interval

Recurring test for detecting hidden dangerous failures in a safety-related system so that a repair, if needed, can restore the system to an "as new" condition or as close to this condition as is practically possible.

Real-time Ethernet

Ethernet for isochronous cycle times of < 1 ms, for example, to meet the high real-time requirements of drive technology.

Runtime software

The runtime software is a process visualization software used to test a project on a configuration PC.

Screen

A screen is a form of visualization of all logically related process data of a plant. The visualization of the process data can be supported by graphic objects.

STEP 7

STEP 7 is the programming software for SIMATIC S7, SIMATIC C7 and SIMATIC WinAC PLCs.

Symbolic I/O field

A symbolic I/O field is a field for the input or output of a value. Contains a list of default entries from which one can be selected.

System event

A system event is assigned to the "System" alarm class. A system event refers to internal states on the HMI device and the PLC.

Tag

Defined memory location to which values can be written to and read from. This can be done from the PLC or the HMI device. Based on whether the tag is interconnected with the PLC or not, we distinguish between "external" tags (process tags) and "internal" tags.

Telnet

Telnet is the name of a network protocol widely used on the Internet. The client-server protocol is based on character-based data exchange over a TCP connection. Programs that implement the function of the terminal device are also frequently called Telnet.

Transfer

Transfer of a runtime project from the configuration PC to the HMI device.

Index

A

- Activate
 - Security mode, 90
- Address assignment
 - TCP/IP network, 132
- Australia
 - Labeling, 220

B

- Backlighting
 - Reducing, 107
- Backup, 145, 147, 149, 152, 156
 - Registry information, 115
 - Temporary files, 115
 - To external storage device, 145, 194
 - via PC, 194
 - With ProSave, 195
- Basic knowledge
 - Required, 3
- Booting, 102
- Box ID, 180, 181
 - Setting, 71
- Brightness
 - Changing, 96
- Bus connection, 253
- Bypass
 - Emergency stop / stop, 27
- Bypass period, 234
- Byte assignment
 - Direct key, 184

C

- Calibrating
 - Touch screen, 100
- Cancel
 - Transfer, 85
- Care, 217
 - HMI device, 218
- CE marking, 219
- Certificates, 219
- Certificates Stores, 124
- Certifications and approvals, 219

- Changing
 - Brightness, 96
- Character repeat
 - Screen keyboard, 98
- Charging time, 234
- Chemical resistance, 217
- Cleaning, 217
- Clearance
 - Connection box compact, 44
 - Connection box, advanced, 46
 - Connection box, standard, 46
 - Wall-mounting bracket, 49
- Clock, 234
- Closing
 - Project, 208
- Commissioning
 - Safety, 33
- Communication error, 267
- Compatibility
 - Connection box, 29
 - Mobile Panel, 30
- Computer name
 - For network operation, 131
- Computers
 - Addressing, 130
- Configuration
 - Steps, 165
- Configuration PC, 189
 - Connecting, 54, 69
- Configuration phase, 189
- Configuration software, 24
- Configure
 - Screen keyboard, 97
- Connecting
 - Configuration PC, 54, 69
 - Connecting cable, 73
 - Equipotential bonding, 62
- Connecting cable
 - Connecting, 73, 74
 - Design, 17
 - Unplugging, 74, 211
- Connection box
 - Box ID, 180, 181
 - Connection point recognition, 179
 - Connection sequence, 59
 - Open, 60
 - Removing, 75
 - Rotary encoder switch, 71

- Connection box advanced
 - Fast connector, 249
 - Wiring, 251
- Connection box compact
 - Clearance, 44
 - Mounting cutout, 43
 - Mounting position, 43
 - Plug-in terminal strip, 245, 249
 - Wiring, 246
- Connection box standard
 - Fast connector, 249
 - Plug-in terminal strip, 245, 249
 - Wiring, 250
- Connection box, advanced
 - Clearance, 46
 - Installation, 46
 - Mounting position, 45
- Connection box, compact
 - Installation, 45
- Connection box, standard
 - Clearance, 46
 - Installation, 46
 - Mounting position, 45
- Connection graphic
 - Equipotential bonding, 63
- Connection point recognition, 28
- Connections to PLC
 - Quantity, 253
- Control Panel
 - Functions, 91
 - Open, 90
 - Operating, 93
 - Screen keyboard, 93
- Controlling
 - Safety program, 258
- Convention
 - Style, 4
 - Term, 5
- Cookie, 121

D

- Data channel
 - Enabling, 109
 - Locking, 109
 - Parameter assignment, 109
- Date
 - Setting, 104
 - Synchronizing, 105
- Date format, 103
- Date/time properties, 104
- Decimal, 207

- Default gateway, 132
- Degree of protection
 - Connection boxes, 237
 - Mobile Panel, 235
- Delay time, 112
- Delete
 - Certificate, 124
- Design
 - Connecting cable, 17
 - Wall-mounting bracket, 21
- DHCP, 132
- Dimension drawings, 225
- Direct key, 205
 - Bit assignment, 186
 - Byte assignment, 184
- Display, 233
- Displaying
 - Displaying information about the HMI device, 118
 - Infotext, 208
 - Memory information, 117, 160, 163
 - System information, 111, 117, 160, 163
- Disposal, 218
- Disturbance variable
 - Pulse-shaped, 222
 - Sinusoidal, 222
- DNS
 - Server, 130
- DNS,
- Documentation
 - Enclosed, 4
- Double-click
 - Setting, 99

E

- EAC marking, 220
- Electrical potential difference, 62
- Electrical system
 - Safety, 34
- Emergency stop, 26
- Emergency stop / stop button
 - Function test, 217
- Emergency stop / stop bypass, 27
- Emergency stop button
 - Operating, 84
- Emission, 223
- Enabling button, 41
 - Function test, 217
 - Operating, 82
 - Panic activation, 82
 - Switch positions, 82
- Enabling device, 41
- Encryption, 123

Encryption protocol, 121
 Entering
 Hexadecimal value in the project, 206
 Value in the project, 207
 Entry on the HMI device
 By means of function key, 204
 Equipotential bonding
 Cable, 62
 Connecting, 62
 Connection graphic, 63
 Requirements, 62
 Error
 Internal, 267
 ErrorCode message, 267
 ESD, 34
 Ethernet settings
 IP address, 132
 EU Declaration of Conformity, 220

F

F FB
 Interconnection, 259
 F I/O DB, 259
 F_FB_KTP_Mobile
 Purpose, 262
 Factory settings
 With ProSave, 198
 Fail-safe automation system, 25
 Fail-safe operation, 26
 Software, 24
 Technical specifications, 239
 Fast connector
 Assignment, 249
 Figure, 6
 Firmware, 119
 Front view
 HMI device, 15
 F-system, 25
 Hardwired, 142
 PROFIsafe-based, 142
 Function key
 Global assignment, 204
 Local assignment, 204
 Pressing, 79
 Function test
 Fail-safe operator controls, 217
 HMI device, 85

H

Hexadecimal value
 Entering in the project, 206
 High-frequency radiation, 34
 HMI device
 Care, 218
 Displaying information, 118
 Front view, 15
 Function test, 85
 Holding, 77
 Interfaces, 16
 Logoff, 27
 Logon, 27
 Operating, 77
 Performance features, 254
 Rear view, 16
 Restarting, 102
 Setup mode, 78
 Side view, 15
 Switch off, 86
 Switching on, 85
 Testing, 85
 Transferring a license key, 201
 Using stationary, 78
 WinCC system limits, 254
 HMI Input Panel
 Options, 97
 Holding
 HMI device, 77
 Homepage
 Internet, 119

I

I/Os
 F_FB_KTP_Mobile, 260
 F_FB_KTP_RNG, 263
 Identification, 133
 Illuminated pushbutton
 Bit assignment, 187
 Pressing, 79
 Importing
 Certificate, 124
 Information
 For the HMI device, 118
 Infotext
 Displaying, 208
 Initial startup, 189
 Input device, 233
 Inputs
 F_FB_KTP_Mobile, 260
 F_FB_KTP_RNG, 263

- Inserting
 - USB flash drive, 58
- Installation
 - Connection box, advanced, 46
 - Connection box, compact, 45
 - Connection box, standard, 46
 - EMC-compatible, 221
 - Wall-mounting bracket, 50
- Installation according to the instructions, 33
- Installing
 - WinCC option, 190, 200
- Insulation testing
 - Connection boxes, 237
 - Mobile Panel, 235
- Interfaces, 16
 - Connection box compact, 244
 - Connection boxes standard and advanced, 248
 - Post connector, pin assignment, 243
 - PROFINET (LAN), pin assignment, 243
 - USB 2.0 Type A, pin assignment, 243
- Internal error, 267
- Internet
 - Browser, 88
 - E-mail, 134
 - Explorer, 88
 - Homepage, 119
 - Telnet, 136
- Internet browser, 119
- Internet options
 - Advanced, 121
 - Connection, 120
 - General, 119
 - Privacy, 121, 123
- IP address
 - Ethernet, 132

K

- Keyswitch
 - Bit assignment, 188
 - Operating principle, 80
 - Pressing, 79
- Korea approval, 220

L

- Labeling, 219
- LED function key
 - Bit assignment, 187
- License
 - Managing, 201
- License key
 - Transferring, 201

- Limit test, 207
- Logoff, 211
 - HMI device, 27
 - Mobile Panel, 28
- Logon, 209
 - HMI device, 27
 - Mobile Panel, 27
- Logon data, 133

M

- MAC address, 126
- Maintenance, 216
- Managing
 - License, 201
- Measures
 - Organizational, 28
- Memory, 234
- Memory information
 - Displaying, 117, 160, 163
- Memory management, 113
- Message
 - ErrorCode, 267
- Mobile Panel
 - Connection sequence, 51
 - Logoff, 28
 - Logon, 27
 - Replacing, 215
 - Replugging, 212
- Mobile Panel interfaces, 234
- Mobile Panel power supply, 234
- Mounting
 - Intended, 33
- Mounting cutout
 - Connection box compact, 43
- Mounting position
 - Connection box compact, 43
 - Connection box, advanced, 45
 - Connection box, standard, 45
 - Wall-mounting bracket, 48

N

- Name server, 133
- Network ID, 133
- Network operation
 - Computer name, 131
- Network parameters
 - Setting, 132
- Network&Dial-Up Connections, 132
- New Zealand
 - Labeling, 220

- NTP
 - Setting up, 127
- Number format, 103
- Numerical value
 - Decimal places, 207
 - Limit test, 207
- O**
- Offline
 - Operating mode, 189
 - Test, 193
- Online
 - Operating mode, 190
 - Test, 193
- OP properties
 - Device, 102, 118
 - Firmware, 119
 - Memory monitoring, 113
 - Message buffer, 114
 - Persistent storage, 115
 - Touch, 100
- Open
 - Connection box, 60
 - Control Panel, 90
- Operating
 - Control Panel, 93
 - Emergency stop button, 84
 - Enabling button, 82
 - Feedback, 203
 - HMI device, 77
- Operating instructions
 - Purpose, 3
 - Scope, 3
- Operating mode, 189
 - Changing, 183
 - E-stop button evaluated by PROFIsafe, 143
 - E-stop button evaluated by safety relay, 143
 - Offline, 189
 - Online, 190
 - Safety-related, 143
 - Stop button evaluated by safety relay, 143
 - Transfer, 86, 190
- Operating principle
 - F_FB_KTP_RNG, 265
- Operating safety
 - Standards, 38
- Operating state
 - Safe, 25
- Operating system
 - Parameter assignment, 87
 - Updating, 190, 196
- Operating the HMI device
 - Safety, 35
- Operation feedback, 203
- Operational safety, 31
- Operator control
 - Safety-related, 26
- Operator input options, 203
- Outputs
 - F_FB_KTP_Mobile, 261
 - F_FB_KTP_RNG, 264
- Overvoltage category, 235
- P**
- Panic activation
 - Enabling button, 82
- Parameter assignment
 - Data channel, 109
 - Operating system, 87
- Password
 - Removing, 106
 - Setting up, 106
- Password properties, 105
- Password protection
 - Setting up, 105
- Performance features
 - HMI device, 254
- PII
 - Start address, 262, 265
- PIQ
 - Start address, 262, 265
- PLC
 - Compatible, 253
- Pollution level, 235
- Post connector
 - Pin assignment, 243
- Power loss, 238
- Power supply
 - Connection boxes, 236
- Pressing
 - Function key, 79
 - Illuminated pushbutton, 79
 - Keypad, 79
- Printer connection
 - Setting, 116
- Printer Properties, 116
- Process control phase, 189
- PROFINET
 - Addressing computers, 130
- PROFINET (LAN)
 - Pin assignment, 243

- PROFINET IO
 - Disabling direct keys, 126
 - Enabling direct keys, 126
- PROFIsafe
 - Address, 129
- Project
 - Closing, 208
 - Offline testing, 193
 - Reuse, 190
 - Safety, 31
 - Testing online, 193
 - Transferring, 189, 190
- ProSave
 - Reset to factory settings, 198
 - Update operating system, 197
- Protection class
 - Connection boxes, 237
 - Mobile Panel, 235
- Protective cover, 60
- Protocol
 - PLC, 253
- Proxy server
 - HMI device, 120

R

- Radiation, 34
- Radio interference, 38
 - Emission, 223
- Reaction times, 239
- Rear view
 - HMI device, 16
- Recommissioning, 189
- Recycling, 218
- Regional and language settings, 103
- Registry information
 - Backup, 115
- Removing
 - Password, 106
 - WinCC option, 190, 200
- Replacing
 - Mobile Panel, 215
- Replugging
 - Mobile Panel, 212
- Reset to factory settings, 198
- Resetting to factory settings, 190
- Restart, 102
- Restoring, 190
 - From external storage device, 147, 149, 152, 156, 194
 - via PC, 194
 - With ProSave, 195

- Risk assessment, 38
- Rotary encoder switch, 71

S

- Safe operating state, 25
- Safety
 - Commissioning, 33
 - During operation, 35
 - Electrical system, 34
 - Operation, 31
 - Project, 31
 - Standards, 38
- Safety characteristics, 240
- Safety program
 - Controlling, 258
 - Interconnection of the blocks, 259
 - Required blocks, 258
- Safety relay
 - SIRIUS, 23
- Safety-related operator control, 26
- Safety-related operator controls, 26
- Scope of delivery, 20
- Screen keyboard
 - Change display, 95
 - Character repeat, 98
 - Configure, 97
 - For Control Panel, 93
 - Representation type, 93
- Screen saver, 107
 - Setting, 107
- Security mode
 - Activate, 90
- Setting
 - Box ID, 71
 - Date, 104
 - Date format, 103
 - Double-click, 99
 - Language, 206
 - Network parameters, 132
 - Number format, 103
 - Printer connection, 116
 - Regional data, 103
 - Screen saver, 107
 - SMTP server, 134
 - Storage location, 112
 - Telnet service, 136
 - Time, 104
 - Time format, 103
 - Transfer mode, 191
- Setting language, 206
- Setting the plant area, 71

- Setting the regional, 103
- Setting up
 - NTP, 127
 - Password, 106
 - Password protection, 105
- Setting up the time server, 127
- Shutdown behavior
 - Emergency stop, 26
- Side view
 - HMI device, 15
- SIMATIC HMI memory card, 22
- SIRIUS safety relay, 23
- Sm@rtServer, 138
- SMTP server, 134
 - Setting, 134
- SOAP, 140
- Software
 - Fail-safe operation, 24
- Spare key
 - HMI device, 22
- Standard
 - TÜV, 221
- Standards, 5
- Start
 - HMI device, 102
 - Transfer, 192
- Start Center
 - Buttons, 87
- Stop categories, 39
- Storage location
 - Setting, 112
- Storage media, 22
- Storage medium
 - Restoring from external, 147, 149, 152, 156
 - Saving to external, 145
- Subnet mask, 132
- Switch off
 - HMI device, 86
- Switch position
 - Enabling button, 82
- Switching on
 - HMI device, 85
- Synchronizing
 - Date and time, 105
- System event
 - Information system, 269
 - Parameter, 269
- System information
 - Displaying, 111, 117, 160, 163
- System properties
 - Device name, 131

- General, 117, 160, 163
- Memory, 111

T

- TCP/IP address, 132
- Technical specifications
 - Connection boxes power supply, 236
 - Connection boxes weight, 236
 - Display, 233
 - Fail-safe operation, 239
 - Input device, 233
 - Memory, 234
 - Mobile Panel interfaces, 234
 - Mobile Panel power supply, 234
 - Mobile Panel weight, 233
- Telnet service
 - Setting, 136
- Temporary files
 - Backup, 115
- Testing
 - HMI device, 85
- Time
 - Setting, 104
 - Synchronizing, 105
- Time format, 103
- Time zone
 - Setting, 104
- Touch screen, 88
 - Calibrating, 100
- Transfer, 189
 - Cancel, 85
 - Operating mode, 190
 - Start, 192
 - Starting automatically, 191
- Transfer mode
 - Setting, 191
- Transfer settings, 109
 - Channel, 109
 - Directories, 112
- Transferring
 - License key, 201
 - Project, 189, 190

U

- UL marking, 220
- Unplugging
 - Connecting cable, 211
 - USB flash drive, 58
- Updating
 - Operating system, 190, 196
- USB 2.0 Type A
 - Pin assignment, 243
- USB flash drive, 22
 - Inserting, 58
 - Unplugging, 58
- Use
 - in mixed-use zone, 37
 - In residential areas, 38
 - Industrial, 37
- User name, 133
- Using stationary
 - HMI device, 78

V

- Value
 - Entering in the project, 207

W

- Wall-mounting bracket
 - Clearance, 49
 - Design, 21
 - Installation, 50
 - Mounting position, 48
- Web Server, 140
- Weight
 - Connection boxes, 236
 - Mobile Panel, 233

- WinCC Internet settings
 - E-mail, 134
 - Sm@rtServer, 138
 - Telnet, 136
 - Web Server, 140
- WinCC option
 - Installing, 190, 200
 - Removing, 190, 200
- WinCC system limits
 - HMI device, 254
- WINS, 133
 - Server, 130
- Wiring
 - Connection box advanced, 251
 - Connection box compact, 246
 - Connection box standard, 250