

SIEMENS

SIMATIC

Measurement Hardware for SIMATIC Energy Suite in the TIA Portal

Configuration Manual

Preface

Energy data from measurement hardware	1
Driver blocks for measurement hardware	2
ET 200SP AI Energy Meter 480VAC ST	3
SENTRON PAC3200/4200	4
SENTRON 3VA	5
SINAMICS AC/AC	6
SIMOCODE pro V PN	7
ET 200SP/M200D Motor Starter	8
3RW44 Soft Starter	9

Legal information

Warning notice system

This manual contains notices you have to observe in order to ensure your personal safety, as well as to prevent damage to property. The notices referring to your personal safety are highlighted in the manual by a safety alert symbol, notices referring only to property damage have no safety alert symbol. These notices shown below are graded according to the degree of danger.

DANGER

indicates that death or severe personal injury **will** result if proper precautions are not taken.

WARNING

indicates that death or severe personal injury **may** result if proper precautions are not taken.

CAUTION

indicates that minor personal injury can result if proper precautions are not taken.

NOTICE

indicates that property damage can result if proper precautions are not taken.

If more than one degree of danger is present, the warning notice representing the highest degree of danger will be used. A notice warning of injury to persons with a safety alert symbol may also include a warning relating to property damage.

Qualified Personnel

The product/system described in this documentation may be operated only by **personnel qualified** for the specific task in accordance with the relevant documentation, in particular its warning notices and safety instructions. Qualified personnel are those who, based on their training and experience, are capable of identifying risks and avoiding potential hazards when working with these products/systems.

Proper use of Siemens products

Note the following:

WARNING

Siemens products may only be used for the applications described in the catalog and in the relevant technical documentation. If products and components from other manufacturers are used, these must be recommended or approved by Siemens. Proper transport, storage, installation, assembly, commissioning, operation and maintenance are required to ensure that the products operate safely and without any problems. The permissible ambient conditions must be complied with. The information in the relevant documentation must be observed.

Trademarks

All names identified by ® are registered trademarks of Siemens AG. The remaining trademarks in this publication may be trademarks whose use by third parties for their own purposes could violate the rights of the owner.

Disclaimer of Liability

We have reviewed the contents of this publication to ensure consistency with the hardware and software described. Since variance cannot be precluded entirely, we cannot guarantee full consistency. However, the information in this publication is reviewed regularly and any necessary corrections are included in subsequent editions.

Preface

Purpose of the documentation

This documentation supports you in using measurement hardware for energy management functions with SIMATIC Energy Suite in STEP 7 (TIA Portal).

Basic knowledge required

The following knowledge is required in order to understand the documentation:

- Proficiency with STEP 7 (TIA Portal) and WinCC (TIA Portal)
- Proficiency with handling measurement hardware for provision of energy data

Validity of the documentation

This documentation is valid for the use of the following measurement hardware with SIMATIC Energy Suite V15.0:

- ET 200SP AI Energy Meter 480VAC ST
- SENTRON PAC3200/PAC4200
- SENTRON 3VA (8er ETU)
- SINAMICS AC/AC
- SIMOCODE pro V PN
- ET 200SP Motor Starter
- M200D Motor Starter
- 3RW44 Soft Starter

For the full use of the energy management functions, you also require the function manual SIMATIC Energy Suite V15.0 (on the SIMATIC Energy Suite DVD).

You can find an overview of the necessary software and hardware requirements (including the firmware versions of the measurement hardware) in the Readme file of the Energy Support Library.

Conventions

Read also the following highlighted information:

Note

The notes contain important information on the product described in the documentation, on the handling of the product or on the part of the documentation to which particular attention should be paid.

Additional assistance

- Information about the technical support available can be found in the appendix to this documentation.
- The range of technical documentation for the individual SIMATIC products and automation systems is available on the Internet (<http://www.siemens.com/simatic-tech-doku-portal>).
- The online catalog and the ordering system are available on the Internet (<https://mall.industry.siemens.com>).

Security information

Siemens provides products and solutions with industrial security functions that support the secure operation of plants, systems, machines and networks.

In order to protect plants, systems, machines and networks against cyber threats, it is necessary to implement – and continuously maintain – a holistic, state-of-the-art industrial security concept. Siemens' products and solutions only form one element of such a concept.

Customer is responsible to prevent unauthorized access to its plants, systems, machines and networks. Systems, machines and components should only be connected to the enterprise network or the internet if and to the extent necessary and with appropriate security measures (e.g. use of firewalls and network segmentation) in place.

Additionally, Siemens' guidance on appropriate security measures should be taken into account. For more information about industrial security, please visit (<http://www.siemens.com/industrialsecurity>).

Siemens' products and solutions undergo continuous development to make them more secure. Siemens strongly recommends to apply product updates as soon as available and to always use the latest product versions. Use of product versions that are no longer supported, and failure to apply latest updates may increase customer's exposure to cyber threats.

To stay informed about product updates, subscribe to the Siemens Industrial Security RSS Feed under (<http://www.siemens.com/industrialsecurity>).

Table of contents

	Preface	3
1	Energy data from measurement hardware.....	9
2	Driver blocks for measurement hardware	12
2.1	Structure of the energy program for measurement hardware	12
2.2	Energy data processing based on the "IPO" principle.....	14
2.3	Area: Input	15
2.4	Area: Processing.....	15
2.5	Area: Output.....	18
2.6	Coordinating acyclic communication	19
2.7	Overview of the measurement hardware functionality.....	21
3	ET 200SP AI Energy Meter 480VAC ST.....	22
3.1	Description of AI Energy Meter 480VAC ST.....	22
3.2	Mode of operation of the driver blocks for AI Energy Meter 480VAC ST	23
3.3	EnSL_DrvBasic_EM_vx: Acquire basic energy data	25
3.3.1	Description of EnSL_DrvBasic_EM_vx	25
3.3.2	EnSL_DrvBasic_EM_vx parameter.....	29
3.3.3	Status parameter	29
3.3.4	Alarms of EnSL_DrvBasic_EM_vx.....	30
3.4	EnSL_DrvAdv_EM_vx: Acquire advanced energy data.....	30
3.4.1	Description of EnSL_DrvAdv_EM_vx.....	30
3.4.2	EnSL_DrvAdv_EM_vx parameter	32
3.4.3	Status parameter	32
3.5	EnSL_DrvAddReal_EM_vx: Acquire additional energy data of REAL type	33
3.5.1	Description of EnSL_DrvAddReal_EM_vx	33
3.5.2	EnSL_DrvAddReal_EM_vx parameter.....	35
3.5.3	Status parameter	38
3.6	EnSL_DrvAddLReal_EM_vx: Acquire additional energy data of REAL type	38
3.6.1	Description of EnSL_DrvAddLReal_EM_vx	38
3.6.2	EnSL_DrvAddLReal_EM_vx parameter.....	40
3.6.3	Status parameter	41
3.7	EnSL_DrvAdvMinMax_EM_vx: Acquire advanced minimum and maximum values	41
3.7.1	Description of EnSL_DrvAdvMinMax_EM_vx	41
3.7.2	EnSL_DrvAdvMinMax_EM_vx parameter.....	43
3.7.3	Status parameter	43

3.8	User-defined data types (UDTs) from Energy Meter	44
3.8.1	EnSL_typeAddEM	44
3.8.1.1	Description of EnSL_typeAddEM	44
3.8.1.2	Structure of EnSL_typeAddEM	44
4	SENTRON PAC3200/4200	45
4.1	Description of SENTRON PAC3200/4200	45
4.2	Mode of operation of the driver blocks for SENTRON PAC3200/4200	46
4.3	EnSL_DrvBasic_PAC_vx: Acquire basic energy data	48
4.3.1	Description of EnSL_DrvBasic_PAC_vx	48
4.3.2	EnSL_DrvBasic_PAC_vx parameter	51
4.3.3	Status parameter	52
4.3.4	Alarms	52
4.4	EnSL_DrvAdv_PAC_vx: Acquire advanced energy data	52
4.4.1	Description of EnSL_DrvAdv_PAC_vx	52
4.4.2	EnSL_DrvAdv_PAC_vx parameter	54
4.4.3	Status parameter	55
4.5	EnSL_DrvAdvMinMax_PAC_vx: Acquire advanced minimum and maximum values	55
4.5.1	Description of EnSL_DrvAdvMinMax_PAC_vx	55
4.5.2	EnSL_DrvAdvMinMax_PAC_vx parameter	57
4.5.3	Status parameter	58
4.6	EnSL_DrvAddReal_PAC_vx: Acquire additional energy data of the REAL type	58
4.6.1	Description of EnSL_DrvAddReal_PAC_vx	58
4.6.2	EnSL_DrvAddReal_PAC_vx parameter	60
4.6.3	Status parameter	64
4.7	EnSL_DrvAddLReal_PAC_vx: Acquire additional energy data of the type LREAL	64
4.7.1	Description of EnSL_DrvAddLReal_PAC_vx	64
4.7.2	EnSL_DrvAddLReal_PAC_vx parameter	66
4.7.3	Status parameter	67
4.8	User-defined data types (UDTs) from SENTRON PAC3200/4200	67
4.8.1	EnSL_typeAdvPAC	67
4.8.1.1	Description of EnSL_typeAdvPAC	67
4.8.1.2	Structure of EnSL_typeAdvPAC	67
4.8.2	EnSL_typeAddSENTRON	68
4.8.2.1	Description of EnSL_typeAddSENTRON	68
4.8.2.2	Structure of EnSL_typeAddSENTRON	68
5	SENTRON 3VA	69
5.1	Description of SENTRON 3VA	69
5.2	Mode of operation of the driver blocks for SENTRON 3VA	70
5.3	EnSL_DrvBasic_3VA_vx: Acquire basic energy data	72
5.3.1	Description of EnSL_DrvBasic_3VA_vx	72
5.3.2	EnSL_DrvBasic_3VA_vx parameter	74
5.3.3	Status parameter	75
5.3.4	Alarms	75

5.4	EnSL_DrvAdv_3VA_vx: Acquire advanced energy data	75
5.4.1	Description of EnSL_DrvAdv_3VA_vx	75
5.4.2	EnSL_DrvAdv_3VA_vx parameter	77
5.4.3	Status parameter	77
5.5	EnSL_DrvAdvMinMax_3VA_vx: Acquire advanced minimum and maximum values	78
5.5.1	Description of EnSL_DrvAdvMinMax_3VA_vx.....	78
5.5.2	EnSL_DrvAdvMinMax_3VA_vx parameter	80
5.5.3	Status parameter	80
5.6	EnSL_DrvAddLReal_3VA_vx: Acquire additional energy data of REAL type.....	81
5.6.1	Description of EnSL_DrvAddLReal_3VA_vx.....	81
5.6.2	EnSL_DrvAddLReal_3VA_vx parameter	83
5.6.3	Status parameter	84
5.7	EnSL_DrvAddReal_3VA_vx: Acquire additional energy data of REAL type.....	84
5.7.1	Description of EnSL_DrvAddReal_3VA_vx.....	84
5.7.2	EnSL_DrvAddReal_3VA_vx parameter	86
5.7.3	Status parameter	90
5.8	User-defined data types (UDTs) from 3VA	90
5.8.1	EnSL_typeAdv3VA.....	90
5.8.1.1	Description of EnSL_typeAdv3VA	90
5.8.1.2	Structure of EnSL_typeAdv3VA.....	90
5.8.2	EnSL_typeAddSENTRON	91
5.8.2.1	Description of EnSL_typeAddSENTRON	91
5.8.2.2	Structure of EnSL_typeAddSENTRON.....	91
6	SINAMICS AC/AC.....	92
6.1	Description of SINAMICS	92
6.2	Mode of operation of the driver blocks for AC/AC converters of the SINAMICS series	93
6.3	EnSL_DrvBasic_Sina_vx: Acquire basic energy data.....	93
6.3.1	Description of EnSL_DrvBasic_Sina_vx	93
6.3.2	EnSL_DrvBasic_PAC_vx parameter.....	95
6.3.3	Status parameter	95
6.3.4	Alarms.....	96
7	SIMOCODE pro V PN.....	97
7.1	Description of SIMOCODE pro V PN.....	97
7.2	Mode of operation of the driver blocks for SIMOCODE pro V	97
7.3	EnSL_DrvBasic_SMCproV_vx: Acquire basic energy data	99
7.3.1	Description of EnSL_DrvBasic_SMCproV_vx.....	99
7.3.2	EnSL_DrvBasic_SMCproV_vx parameter.....	104
7.3.3	Status parameter	104
7.3.4	Alarms.....	105
7.4	EnSL_DrvAdv_SMCproV_vx: Acquire advanced energy data.....	105
7.4.1	Description of EnSL_DrvAdv_SMCproV_vx	105
7.4.2	EnSL_DrvAdv_SMCproV_vx parameter	107
7.4.3	Status parameter	107

7.5	EnSL_DrvAdvMinMax_SMCproV_vx: Acquire advanced minimum and maximum values	107
7.5.1	Description of EnSL_DrvAdvMinMax_SMCproV_vx	107
7.5.2	EnSL_DrvAdvMinMax_SMCproV_vx parameter	109
7.5.3	Status parameter	109
7.6	EnSL_DrvAddReal_SMCproV_vx: Acquire additional energy data of REAL type	110
7.6.1	Description of EnSL_DrvAddReal_SMCproV_vx	110
7.6.2	EnSL_DrvAddReal_SMCproV_vx parameter	112
7.6.3	Status parameter	115
7.7	User-defined data types (UDTs) of SIMOCODE pro V	115
7.7.1	EnSL_typeAdvSMCproV	115
7.7.1.1	Description of EnSL_typeAdvSMCproV	115
7.7.1.2	Structure of EnSL_typeAdvSMCproV	115
7.7.2	EnSL_typAddSMCproV	116
7.7.2.1	Description of EnSL_typAddSMCproV	116
7.7.2.2	Structure of EnSL_typAddSMCproV	116
8	ET 200SP/M200D Motor Starter	117
8.1	Description of ET 200SP/M200D Motor Starter	117
8.2	Mode of operation of the driver blocks for ET 200SP/M200D Motor Starters	118
8.3	EnSL_DrvBasic_MS_vx: Acquiring basic energy data	119
8.3.1	Description of EnSL_DrvBasic_MS_vx	119
8.3.2	EnSL_DrvBasic_MS_vx parameter	121
8.3.3	Status parameter	122
8.3.4	Alarms	122
9	3RW44 Soft Starter	123
9.1	Description of 3RW44 Soft Starter	123
9.2	Mode of operation of the driver blocks for 3RW44 Soft Starter	124
9.3	EnSL_DrvBasic_3RW44_vx: Acquiring basic energy data	125
9.3.1	Description EnSL_DrvBasic_3RW44_vx:	125
9.3.2	Parameter EnSL_DrvBasic_3RW44_vx	127
9.3.3	Parameter status	127
9.3.4	Alarms	128

Energy data from measurement hardware

A variety of devices can provide energy data. In addition to the measuring devices (e.g. ET 200SP AI EnergyMeter 480VAC ST, SENTRON PAC), the sole purpose of which is to measure energy, many automation devices (for example, frequency converters or protection devices and switchgear) provide energy data in addition to their actual automation functions (for example, speed control). In the following, these devices are referred to as measurement hardware.

Overview of measurement hardware for Energy Suite

The following table shows some examples of devices as measurement hardware that are supported by SIMATIC Energy Suite. For this purpose, specific function blocks (FBs) with driver functionality are available for the measurement hardware from the Energy Support Library (EnSL).

Measurement hardware	Description
AI EnergyMeter 480VAC ST	Analog input module for the SIMATIC ET 200SP distributed I/O system for measuring relevant network parameters in the voltage range up to 480V AC phase-to-phase voltage
SETRON PAC3200/PAC4200	Multifunctional measuring device for measuring and displaying relevant power system parameters in low-voltage power distribution
SETRON 3VA (8x ETU)	Molded case circuit breakers for low-voltage power distribution equipment, for example, for protecting production equipment against electrical damage
SINAMICS AC/AC	Converters for efficient and economical operation of pumps, fans and compressors, for example
SIMOCODE pro V PN	Motor protection and control device for motor management tasks such as comprehensive protection, monitoring, safety and control functions between the motor feeder and automation system
ET 200SP/M200D Motor Starter	Motor starter for switching and protecting three-phase induction motors and single-phase AC motors
3RW44 Soft Starter	Soft starter for limiting the starting current and the starting torque. Both mechanical loads and supply voltage failures can be reliably avoided with this starter.

Device configuration of measurement hardware in STEP 7 (TIA Portal)

The device configuration of the measurement hardware is performed in STEP 7 (TIA Portal). The following options are available to add the measurement hardware to the hardware configuration of your project:

- Transfer the device directly from the hardware catalog into the network or topology view
- Add a device not contained in the hardware catalog via a **GSD file** (device master data file) or **HSP** (Hardware Support Packages)

If you want to configure measurement hardware that is not contained in the hardware catalog, you need to first install the vendor-supplied GSD file or HSP. Using GSD files or HSP, installed measurement hardware is displayed in the hardware catalog and can then be selected and configured in the project.

You can find additional information about configuring a device using the GSD file or HSP in the online help of the TIA Portal information system.

Driver blocks of the measurement hardware for STEP 7 (TIA Portal)

The energy data (input measurement data) of the measurement hardware are made available in different ways (e.g. differences in the data format or in the data record address).

In addition to the Energy Suite blocks, function blocks (FBs) specific to the measurement hardware with driver functionality are made available through the **Energy Support Library (EnSL)**. These hardware-specific function blocks (referred to as driver blocks in the following), form the interface between the special measurement hardware and your automation system.

The energy data from the measurement hardware is read and uniformly provided to the automation system using driver blocks. In this way, the raw energy data is provided easier and faster to your PLC program and Energy Suite. The Energie Suite blocks are then used to prepare and process raw energy data.

Energy Support Library (EnSL)

Perform the installation of the Energy Support Library according to the installation instructions for the measurement hardware.

After the successful installation of the Energy Support Library:

- The measurement hardware library with the driver blocks is available in STEP 7 (TIA Portal) as a global library. The driver blocks can be used in the PLC program.
- The measurement hardware can be assigned an energy object for selecting the energy data source.

You can find additional information about using global libraries in the online help of the TIA Portal information system.

Type of communication

The CPU can read the energy data from the measurement hardware in two ways, with cyclic or acyclic communication. The cyclic energy data is transferred to Energy Suite via the process image and the acyclic energy data is transferred in a data record of the measurement hardware.

The type of the communication between the CPU and the measurement hardware depends on the measurement hardware and the driver blocks used. Normally, the basic energy data is transferred via cyclic communication, advanced energy data is transferred via acyclic communication:

- You use cyclic communication for invoice-relevant energy data (for example, power, energy counters) which is processed for monitoring and calculation functions in the CPU.
- Acyclic communication (Page 19) is used for energy data relevant for visualization (e.g. current, voltage), which can be displayed on SIMATIC Comfort Panel or PC.

You can find additional information on communication between the CPU and the measurement hardware used in the documentation of the respective measurement hardware.

Note

If you use multiple pieces of measurement hardware, pay attention to the load on the communication channels that are supported by the CPU used.

Driver blocks for measurement hardware





2.1 Structure of the energy program for measurement hardware

Interaction of Energy Suite blocks and driver blocks for measurement hardware

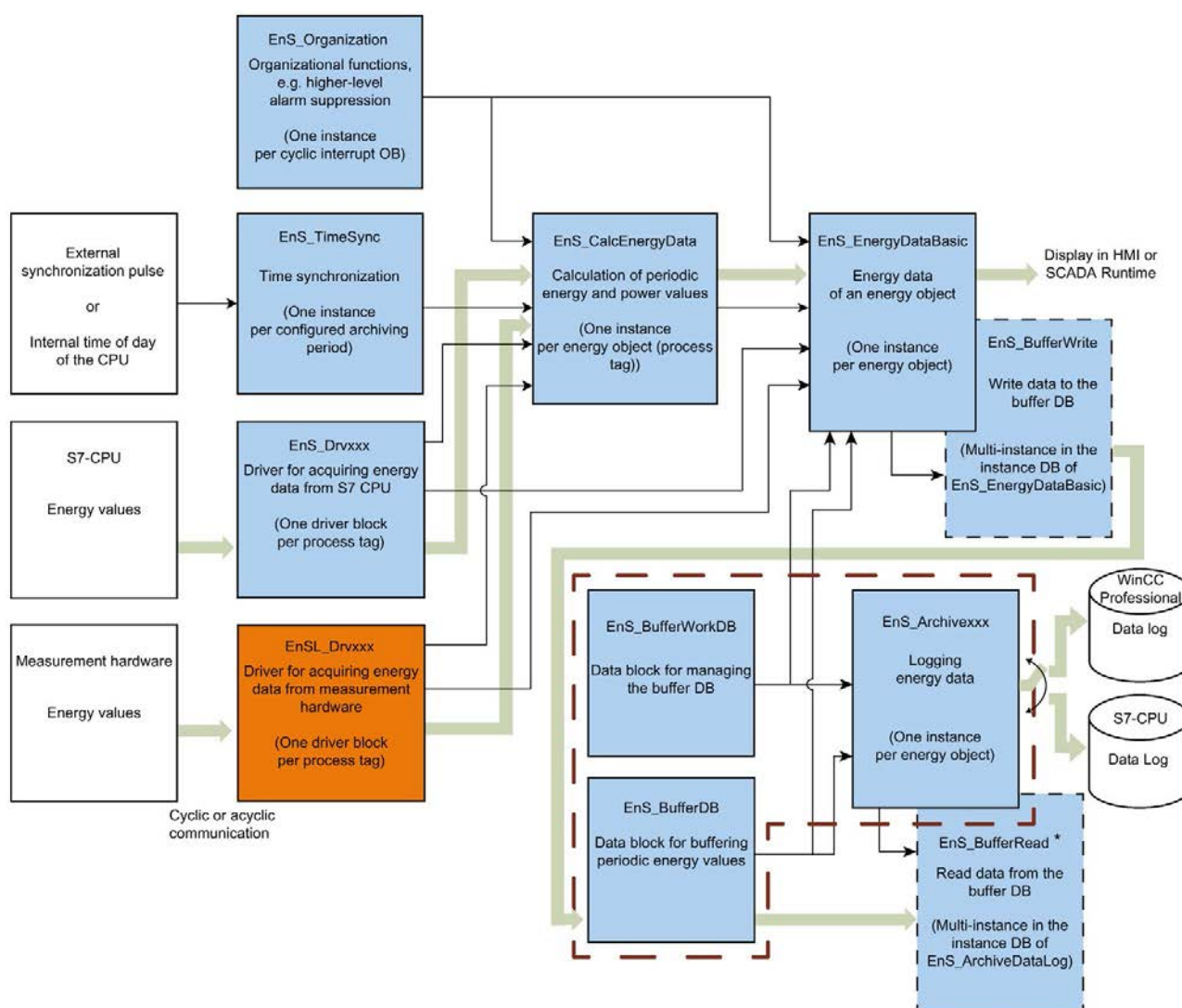
During the generation of the energy program, instances of specific driver blocks for the measurement hardware are automatically created and interconnected (depending on the selected energy data sources) in the "EnS block types" folder of the energy program.

The figure below shows the main mode of operation of the driver blocks for the respective measurement hardware with the Energy Suite blocks:



- * EnS_BufferRead is not called for archiving in WinCC Professional
-  Energy data flow
-  Parameter assignment data
-  Blocks used internally
-  Blocks associated with an energy object table

Guide to the documentation

The following sections (Page 14) of this document describe the **basic interaction** of the Energy Suite blocks and the specific driver blocks for the measurement hardware in the energy program.

For the full use of the energy management functions, you also require the documentation for SIMATIC Energy Suite V15.0. You can find the documentation to the SIMATIC Energy Suite and the Energy Suite blocks

- on the SIMATIC Energy Suite DVD
- or in the online help of the TIA Portal information system under "Processing energy data"

2.2 Energy data processing based on the "IPO" principle

Energy data processing according to the "IPO" principle can be divided into "Input" "Processing" and "Output":

How function blocks work

The following figure shows the general operation of the driver blocks for the measurement hardware according to the "IPO" principle:

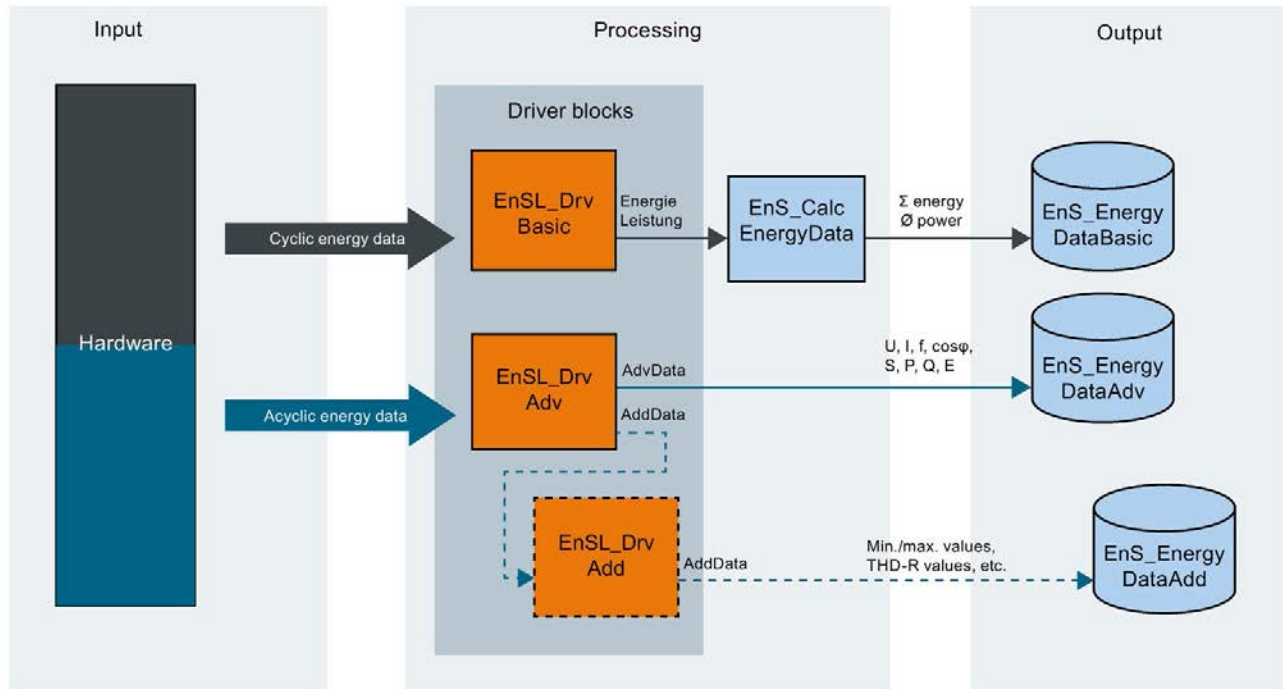

- Energy data via cyclic communication (process image)
- Energy data via acyclic communication (read data record)
- Driver blocks for measurement hardware
- Blocks of the SIMATIC Energy Suite
- Required blocks
- Optional blocks

The following table describes the different areas of the picture:

Area	Description
Input	Contains the measurement hardware (for example, measuring instrument) which provides the input measurement data for processing
Processing	Acquisition, calculation, time stamping and provision of energy values for other systems by the respective function blocks
Output	Provision of periodic energy values for different systems for visualizing, archiving or further evaluation (for example, SIMATIC Energy Manager PRO)

2.3 Area: Input

The measurement hardware is entered in the "Input" area. The driver blocks read the energy measurement data from the measurement hardware. This is done using cyclical communication (process image) and/or acyclic communication (read data record).

The following figure shows "input" according to the "IPO" principle:

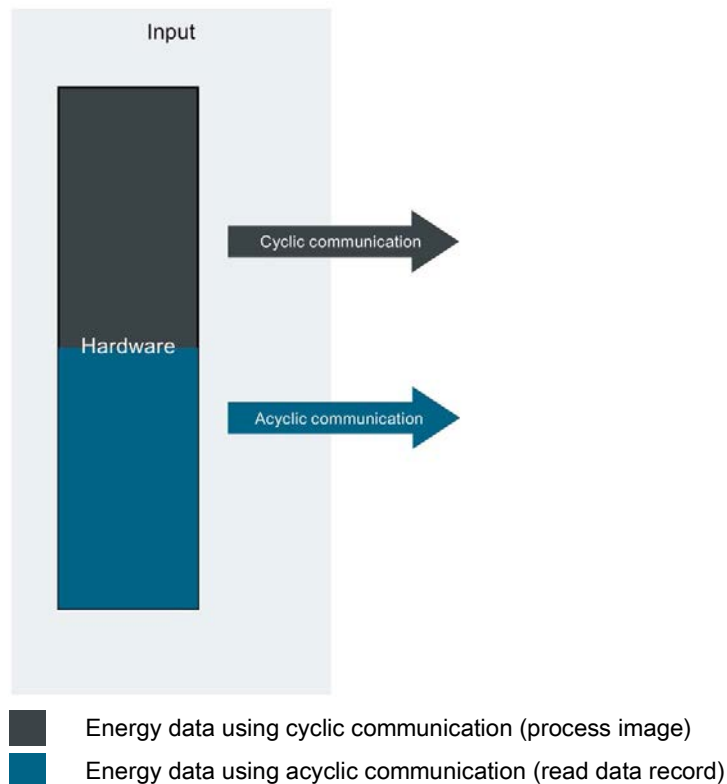

You can find a detailed description of the measurement hardware in the documentation for the respective measuring instrument.

2.4 Area: Processing

In the "processing" area, the energy data from the respective driver blocks are acquired, normalized and prepared as raw energy data that can be easily further processed.

The "Basic", "Adv" and "Add" blocks are located in the "Driver blocks" area. The "EnSL_DrvBasic" driver block passes the current basic energy data to the Energy Suite function block "EnS_CalcEnergyData". The "EnS_CalcEnergyData" function block calculates the energy consumption and the average power over the individually configured archiving period (e.g. 15 min.).

You can find a detailed description of the driver blocks in the documentation for the respective measurement hardware.

The following figure shows an example of "processing" according to the "IPO" principle. The interconnection of the parameters may vary depending on the measurement hardware used.

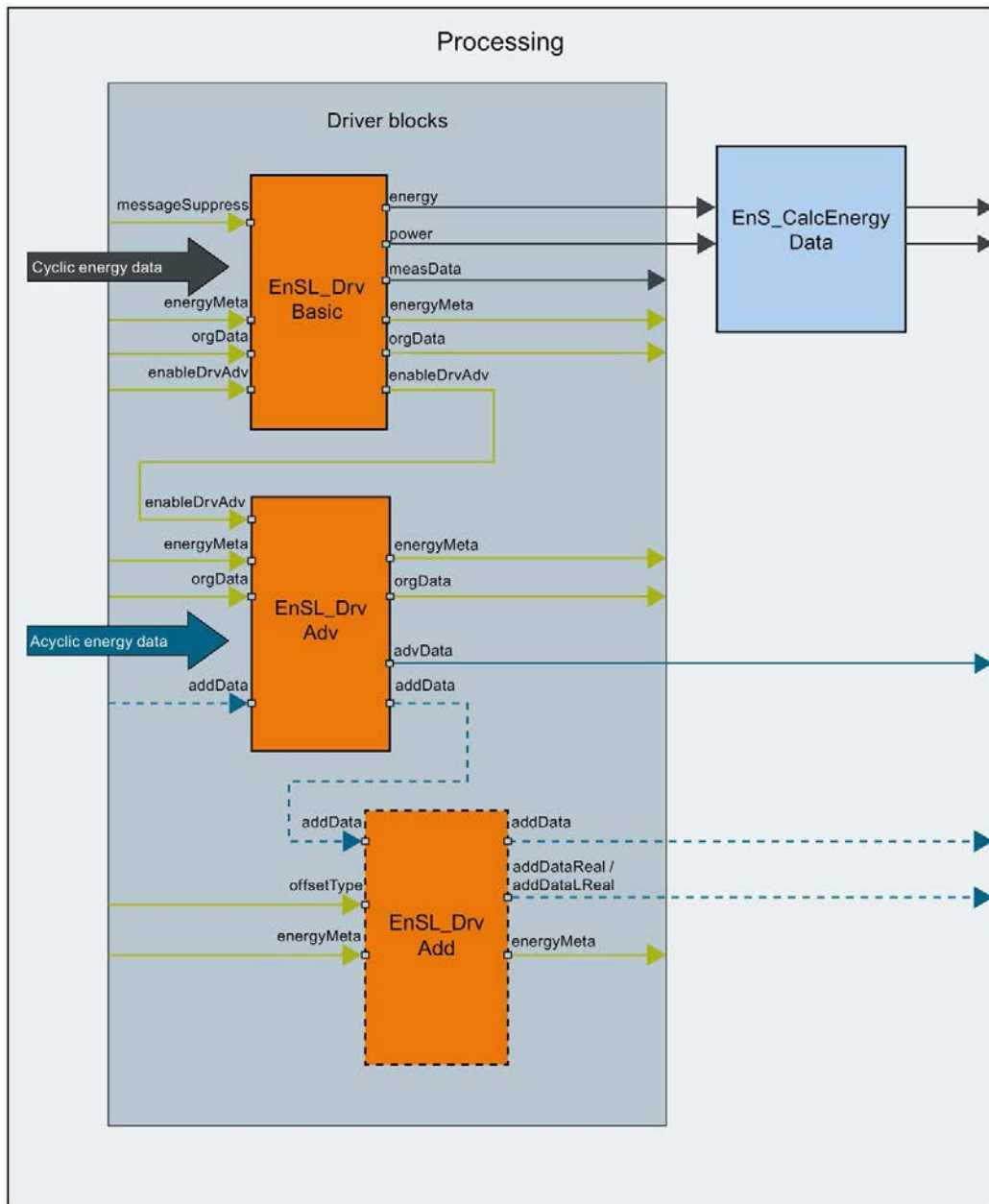

- Cyclic energy data
- Acyclic energy data
- Driver blocks for measurement hardware
- Blocks of the SIMATIC Energy Suite
- Required blocks
- Optional blocks

The following table describes the components of a picture:

Component	Description
EnSL_DrvBasic	Driver block for basic energy data Reads the basic energy data via cyclic communication from the measurement hardware, for example, energy counters, power
EnSL_DrvAdv	Driver block for advanced energy data Reads a data record with advanced energy data via acyclic communication from the measurement of hardware, for example, voltage, current
EnSL_DrvAdd	Driver block for additional energy data Reads a record with additional energy data via acyclic communication from the measurement hardware, for example, harmonics
EnS_CalcEnergyData	Energy Suite block for further processing (periodic calculation, time stamping, etc.) the energy data. You can find additional information on this in the section "EnS_CalcEnergyData".
Cyclic energy data	Predominantly basic energy data that are read by the "EnS_DrvBasic" driver block from the measurement hardware using cyclic communication (process image).
Acyclic energy data	Predominantly advanced and additional energy data that is read by the "EnSL_DrvAdv" and "EnSL_DrvAdd" driver blocks using acyclic communication (read data record).
messageSuppress	Alarm suppression
energyMeta	Process tag specific data You can find additional information on this in the section "EnS_typeEnergyMeta".
orgData	Organization data You can find additional information on this in the section "EnS_typeOrgData".
enableDrvAdv	Processing enable of the "EnSL_DrvAdv" driver block
energy	Current value of the active energy counter
power	Current value of the active power
measValues	Cyclic measurement data that is passed to the "EnSL_DrvAdv" driver block
advData	Extended measured data record
addData	Additional energy data
addDataLReal / addDataReal	Current LREAL/REAL data record

2.5 Area: Output

After acquisition and processing, the energy data are collected in the "Output". The "Output" serves as an interface for visualization with SIMATIC WinCC or other systems (for example, SIMATIC Energy Manager PRO).

The following figure shows "output" according to the "IPO" principle:

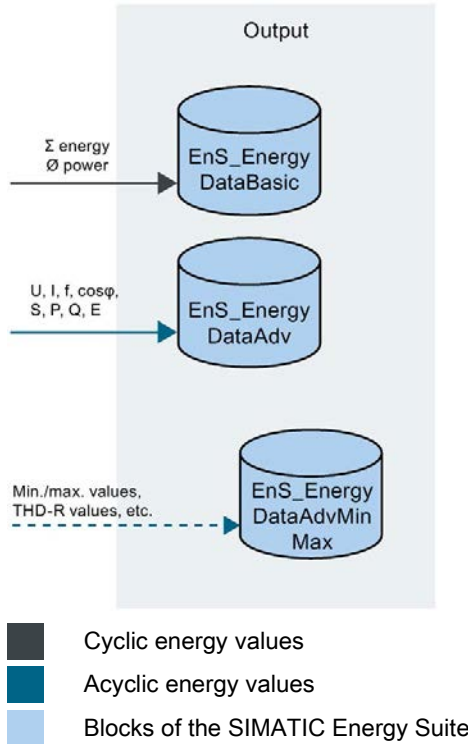

The following table describes the components of a picture:

Function block	Description
EnS_EnergyDataBasic	Energy Suite block for providing the prepared basic energy data and metadata. The cyclic basic energy data are calculated to the following values by the "EnS_CalcEnergyData" Energy Suite block: <ul style="list-style-type: none"> • Energy consumption over a period (for example, 15 min.) • Average power over a period (for example, 15 min.) You can find additional information under "EnS_EnergyDataBasic: Providing metadata and energy values".
EnS_EnergyDataAdv	Energy Suite block for providing a data record with advanced energy values Advanced energy values (acyclic): <ul style="list-style-type: none"> • Voltage, current, $\cos\phi$ • Apparent, active and reactive power etc. You can find additional information under "EnS_EnergyDataAdv: Providing advanced energy values".

Function block	Description
EnS_EnergyDataAdvMinMax	<p>Energy Suite block for providing a data record with minimum and maximum values of the advanced energy values</p> <p>Minimum and maximum values of the advanced energy values:</p> <ul style="list-style-type: none"> • Voltage, current, $\cos \varphi$ • Apparent, active and reactive power <p>You can find additional information under "EnS_EnergyDataAdvMinMax: Providing advanced minimum and maximum values".</p>

2.6 Coordinating acyclic communication

Acyclic communication is used for energy data relevant for visualization (e.g. current, voltage), which can be displayed on SIMATIC Comfort Panel or PC. Ensure you have sufficient CPU resources available when using acyclic communication. The number of communication connections is limited for each CPU.

LAcycCom library

All driver blocks that communicate acyclic with the measurement hardware use blocks to coordinate the acyclic communication from the LAcycCom library. The required blocks, PLC tags and data types are contained in the following Energy Support Library folders:

- LAcycCom_Blocks
- LAcycCom_Tags
- LAcycCom_Types

The figure below shows the LAcycCom components in the "Energy Support Library":

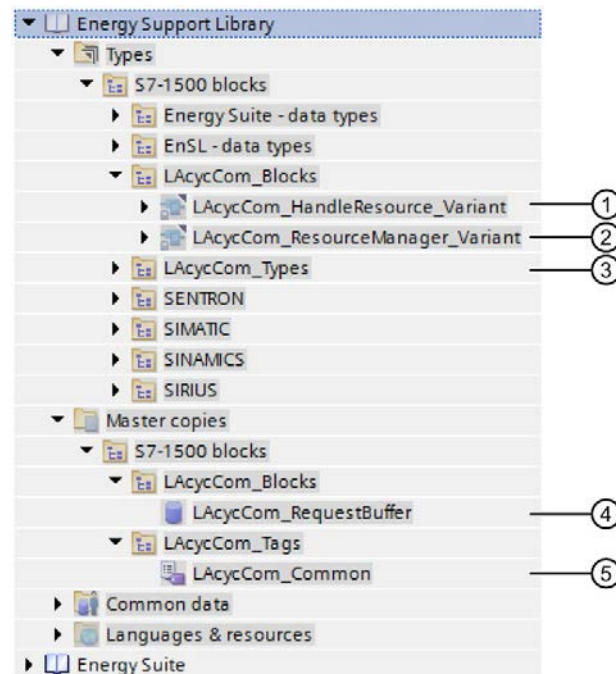

You can find a detailed description of the LAcycCom library on the Web (<https://support.industry.siemens.com/cs/ww/en/view/109479553>).

Requirement

- The "Energy Support Library" library is open in the "Global Libraries" pane.

Configuration steps

The following overview shows the most important configuration steps for coordinating acyclic communication.

Applying instances of the LAcycCom components in your project (project tree):

1. Copy the LAcycCom_HandleResource_Variant function block ① to the program blocks folder.
2. Copy all PLC data types ③ to the PLC data types folder.
3. Copy the LAcycCom_RequestBuffer data block ④ to the program blocks folder.
4. Copy the LAcycCom_Common tag table ⑤ to the PLC tags folder.

Adapt and interconnect LAcycCom blocks:

1. Call the LAcycCom_ResourceManager_Variant block ② in OB1.
2. Set the enable input parameter of the LAcycCom_ResourceManager_Variant block to TRUE.
3. Interconnect the requestBufferHeader in-out parameter of the LAcycCom_ResourceManager_Variant block to the header structure parameter of the LAcycCom_RequestBuffer data block.
4. Interconnect the requestBufferElements in-out parameter of the LAcycCom_ResourceManager_Variant block to the elements parameter of the LAcycCom_RequestBuffer data block.

Result

The project is prepared for acyclic communication of the energy data between measurement hardware and CPU. During the generation of the energy program, the required blocks and data types from the "Energy Support Library" library are used for acyclic communication in the energy program.

2.7 Overview of the measurement hardware functionality

The table below shows the application of driver blocks for the various measurement hardware items.

The placeholder "xxx" in the table means that the abbreviation of the name of the respective measurement hardware is contained in the block name.

Measurement hardware	EnSL_DrvBasic_xxx	EnSL_DrvAdv_xxx	EnSL_DrvAdvMinMax_xxx	EnSL_DrvAdd	
				LReal_xxx	Real_xxx
AI Energy Meter 480VAC ST (Page 22)	X	X	X	X	X
SENTRON PAC3200 (Page 45)	X	X	X	X	X
SENTRON PAC4200 (Page 45)	X	X	X	X	X
SENTRON 3VA (Page 69)	X	X	X	X	X
SINAMICS AC/AC (Page 92)	X	-	-	-	-
SIMOCODE pro V PN (Page 97)	X	X	X	-	X
ET 200SP Motor Starter (Page 117)	X	-	-	-	-
M200D Motor Starter (Page 117)	X	-	-	-	-
3RW44 Soft Starter (Page 123)	X	-	-	-	-

The following section contains the detailed description of the driver blocks for each unit of measurement hardware.

ET 200SP AI Energy Meter 480VAC ST

3.1 Description of AI Energy Meter 480VAC ST

AI Energy Meter 480VAC ST, referred to as Energy Meter, in the following, is designed for machine-level use in a distributed ET 200SP I/O system. The Energy Meter covers more than 200 different electrical measurement and energy values. This gives you transparency about the energy requirement of the individual components of a production plant even at machine level. You can determine the energy consumption and power consumption based on the measured values supply by the Energy Meter. You can determine consumption forecasts and efficiency from the measured values. Measurement data of the power consumption are relevant for the load management and maintenance. You can also use the measurement data to report emissions and determine the CO2 footprint.

Integration in TIA Portal hardware catalog

Energy Meter can be connected via PROFINET IO in the TIA Portal. To configure the hardware, use either the user interface integrated in the TIA Portal or a generic station description file. You can find the corresponding general station description file in the Siemens Industry Online Support (<https://support.industry.siemens.com/cs/?lc=en-WW>).

A specific hardware configuration has to be set in order to use the Energy Meter as energy data source in Energy Suite. You can find the required hardware configuration in the section "Hardware Configuration and Parameter Assignment (Page 25)".

Application

The supplied driver blocks for the Energy Meter are contained in the "Energy Support Library" global library.

The table below shows the driver blocks for the Energy Meter:

Name	Function
EnSL_DrvBasic_EM_vx	Driver block for AI Energy Meter 480VAC ST for basic energy data
EnSL_DrvAdv_EM_vx	Driver block for AI Energy Meter 480VAC ST for advanced energy data
EnSL_DrvAdvMinMax_EM_vx	Driver block for AI Energy Meter 480VAC ST for advanced minimum and maximum values
EnSL_DrvAddReal_EM_vx	Driver block for AI Energy Meter 480VAC ST for additional energy data of the REAL type
EnSL_DrvAddLReal_EM_vx	Driver block for AI Energy Meter 480VAC ST for additional energy data of the LREAL type

Information on maximum adjustable overflow value

Note

Set an overflow value of 1×10^{15} Wh when using the Energy Meter.

3.2 Mode of operation of the driver blocks for AI Energy Meter 480VAC ST

The driver blocks read the energy data from the Energy Meter via cyclic or acyclic communication. You can find the general overview of the energy data processing in the section "Energy data processing based on the "IPO" principle (Page 14)".

The figure below shows the structure and the data flow of the Energy Meter blocks:

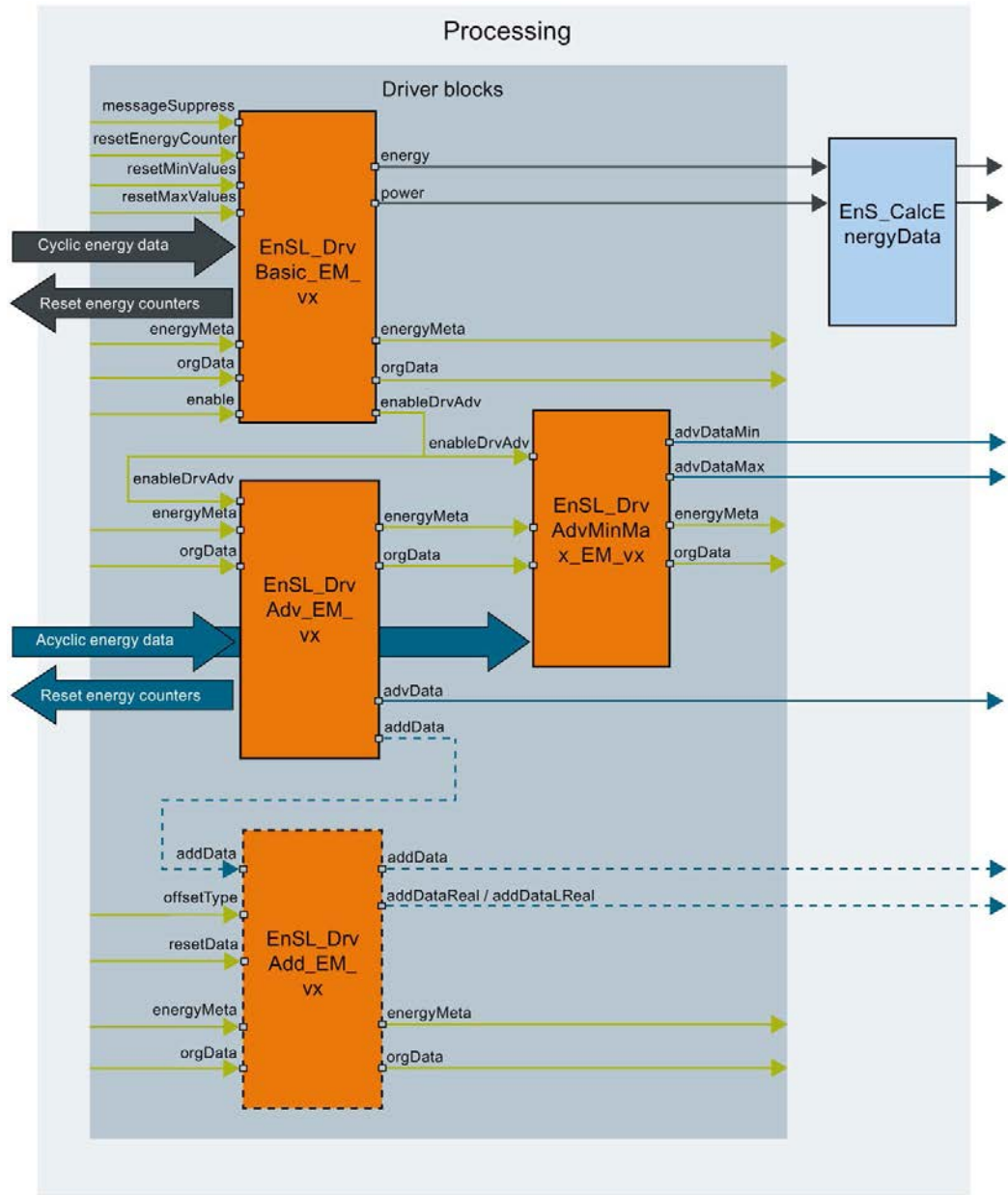

- Energy data via cyclic communication (process image)
- Energy data via acyclic communication (read/write data record)
- Parameter assignment data
- Energy Meter-blocks
- Energy Suite blocks
- Required blocks
- Optional blocks

3.3 EnSL_DrvBasic_EM_vx: Acquire basic energy data

3.3.1 Description of EnSL_DrvBasic_EM_vx

Description

The "EnSL_DrvBasic_EM_vx" function block (FB) reads the basic energy data from the Energy Meter and transfers the energy values to the FB "EnS_CalcEnergyData". These basic energy data are: Momentary active energy and momentary active power.

3.3 EnSL_DrvBasic_EM_vx: Acquire basic energy data

The figure below shows the mode of operation of the "EnSL_DrvBasic_EM_vx" block:

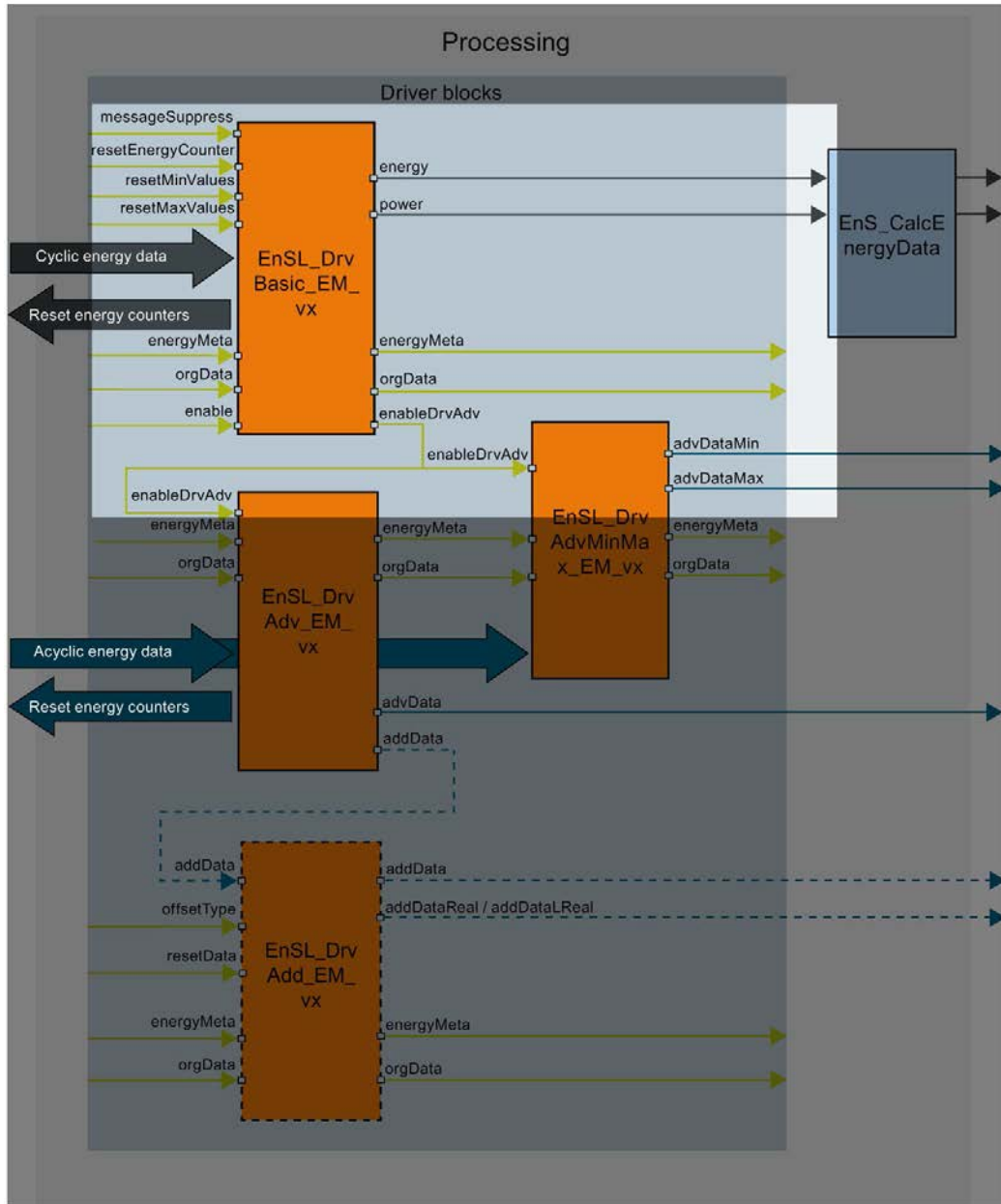

- Energy data via cyclic communication (process image)
- Parameter assignment data
- Energy Meter blocks
- Energy Suite blocks

Hardware configuration and parameter assignment

The energy and power data is transferred cyclic by the Energy Meter to the CPU via the process image. The block requires an input with the hardware ID of the Energy Meter for the transfer. The parameters of the Energy Meter are assigned by configuring the device properties in the hardware configuration (GSDML file).

The Energy Meter provides both the consumed and generated energy as well as the power.

In the metadata of the block "EnS_EnergyDataBasic" you specify if the energy values are derived from an energy consumer or energy generator. You also specify in the metadata whether the recorded basic energy data are sent to the "EnS_CalcEnergyData" block.

The figure below shows an example configuration of the Energy Meter in the Inspector window "Properties":

User data

Operating mode

Enable user data mapping

Module version:

Process data variant:

User data mapping

Category:

Subcategory:

Measured variable:

Insert at input address:

Index	ID	Measured variable	Unit	Data type	I address	Min. value	Max. value	Delete
1	00034	Total active power L1L2L3	W	Float	2..5	-3E+09	3E+09	<input type="checkbox"/>
2	00210	Total active energy import L1L2L3 (Double	Wh	Double	6..13	0	1.7976E+308	<input type="checkbox"/>
3	00211	Total active energy export L1L2L3 (Double	Wh	Double	14..21	0	1.7976E+308	<input type="checkbox"/>
4	00013	Active power L1	W	Float	22..25	-3E+09	3E+09	<input type="checkbox"/>
5	61180	Active energy import L1	Wh	Double	26..33	0	1.7976E+308	<input type="checkbox"/>
6	61181	Active energy export L1	Wh	Double	34..41	0	1.7976E+308	<input type="checkbox"/>
7	00014	Active power L2	W	Float	42..45	-3E+09	3E+09	<input type="checkbox"/>
8	61200	Active energy import L2	Wh	Double	46..53	0	1.7976E+308	<input type="checkbox"/>
9	61201	Active energy export L2	Wh	Double	54..61	0	1.7976E+308	<input type="checkbox"/>
10	00015	Active power L3	W	Float	62..65	-3E+09	3E+09	<input type="checkbox"/>
11	61220	Active energy import L3	Wh	Double	66..73	0	1.7976E+308	<input type="checkbox"/>
12	61221	Active energy export L3	Wh	Double	74..81	0	1.7976E+308	<input type="checkbox"/>

If you require additional measured values in your energy program, you can add the relevant measured values to the default parameter assignment.

3.3 EnSL_DrvBasic_EM_vx: Acquire basic energy data

The table below shows the measured value that can be read from the Energy Meter, depending on the parameter assignment of the "EnS_typeEnergyMeta.connectionType" tag:

connectionType	Measured values
3	Index 1 - 3
15	Index 1 - 6
14	Index 1 - 9
4 - 7	Index 1 - 12

Depending on the setting at the "EnS_typeEnergyMeta.connectionType" you can remove the measured values contained in the corresponding indices from the configuration of the Energy Meter .

The following table shows the detailed information on the "connectionType" parameter:

Number	Connection type
0	Not defined
1	1 phase
2	1 phase - 3 phase (symmetrical)
3	3 phases (symmetrical)
4	3 phases + N (asymmetrical) without voltage transformer / with 3 current transformers 3P4W
5	3 phases + N (asymmetrical) with voltage transformer / with 3 current transformers 3P4WB
6	3 phases + N (symmetrical) without voltage transformer / with 1 current transformer 3P4WB
7	3 phases + N (symmetrical) with voltage transformer / with 1 current transformer 3P4WB
8	3 phases (asymmetrical) without voltage transformer / with 3 current transformers 3P3W
9	3 phases (asymmetrical) with voltage transformer / with 3 current transformers 3P3WB
10	3 phases (asymmetrical) without voltage transformer / with 3 current transformers 3P3W
11	3 phases (asymmetrical) with voltage transformer / with 2 current transformers 3P3W
12	3 phases (symmetrical) without voltage transformer / with 1 current transformer 3P3WB
13	3 phases (symmetrical) with voltage transformer / with 1 current transformer 3P3WB
14	2 phases + N (asymmetrical) without voltage transformer / with 2 current transformers 3P4W
15	1 phase + N without voltage transformer / with 1 current transformer 1P2W
16	3 phases + N (asymmetrical) with voltage transformer / with 3 current transformers 3P3W

Startup

The block has no startup characteristics.

Reaction to error

When an error occurs, the output parameter "error" is set. The "Status (Page 29)" parameter contains additional error information.

3.3.2 EnSL_DrvBasic_EM_vx parameter

The table below shows the block parameters of the ""EnSL_DrvBasic_EM_vx"" function block that are relevant for the Energy Suite:

Parameter	Declaration	Data type	Preasigned value	Description
enable	Input	BOOL	FALSE	Processing enable
messageSuppress	Input	BOOL	FALSE	Message suppression
energy	Output	EnS_typeEnergyCounter	-	Momentary value of the active energy counter
power	Output	EnS_typeAnalogValue	-	Momentary value of the active power
status	Output	WORD	16#00	Block status
orgData	InOut	EnS_typeOrgData	-	Organization data
energyMeta	InOut	EnS_typeEnergyMeta	-	Measuring point-specific data

3.3.3 Status parameter

The table below shows the error codes that are generated at the "status" output parameter when errors occur:

Error code (W#16#...)	Description	Solution
8001	Connection with Energy Meter is interrupted / extended instruction "GETIO_PART" has failed	Establish a connection to the measuring instrument. You can find additional information on error correction in the description of the extended instruction "GETIO_PART".
8008	"GETIO_PART" and "SETIO_PART" extended instructions have failed	You can find additional information on error correction in the description of the extended instruction "GETIO_PART" and "SETIO_PART". The error code of the instruction is contained in the parameter "statusGETIO" and "statusSETIO".
8011	Energy flow direction invalid	Enter a valid value at the parameter for energy flow direction.
8015	Connection type of the measuring instrument "EnS_typeEnergyMeta.connectionType" is invalid ("connectionType" <> 3, 4, 5, 6, 7, 14, 15)	Select the valid connection type of the measuring instrument in the AI configuration from the Energy Meter.
8020	Error(s) in the device Measured value for current or voltage of the individual phases is invalid (see outputs voltageInvalidL1, currentInvalidL1, voltageInvalidL2, currentInvalidL2, voltageInvalidL3, currentInvalidL3).	Check the settings of the measuring instrument. If the error recurs, contact Customer Support or your Siemens representative.

3.3.4 Alarms of EnSL_DrvBasic_EM_vx

The alarms are generated with the "Program_Alarm" instruction. You can find additional information on "Program_Alarm" in the online help of the TIA Portal information system under "Advanced instructions > Alarms".

The table below shows the alarms of the function block "EnSL_DrvBasic_EM_vx":

Alarm block	Alarm text	Alarm class
Program_Alarm	Connection lost	With acknowledgement

The message can be changed.

The alarm can be suppressed with "messageSuppress" or overridden with "orgData.messageSuppress" of the "EnS_Organization" function block.

3.4 EnSL_DrvAdv_EM_vx: Acquire advanced energy data

3.4.1 Description of EnSL_DrvAdv_EM_vx

Description

The "EnSL_DrvAdv_EM_vx" function block reads the data record 142 from the Energy Meter in addition to the basic energy data (EnSL_DrvBasic_EM_vx). This is performed using exclusively acyclic communication. The energy data are referred to as Advanced measured values. The advanced measured values (current, voltage, frequency etc.) are transferred to the output structure at the function block "EnS_EnergyDataAdv".

The figure below shows the mode of operation of the "EnSL_DrvAdv_EM_vx" block:

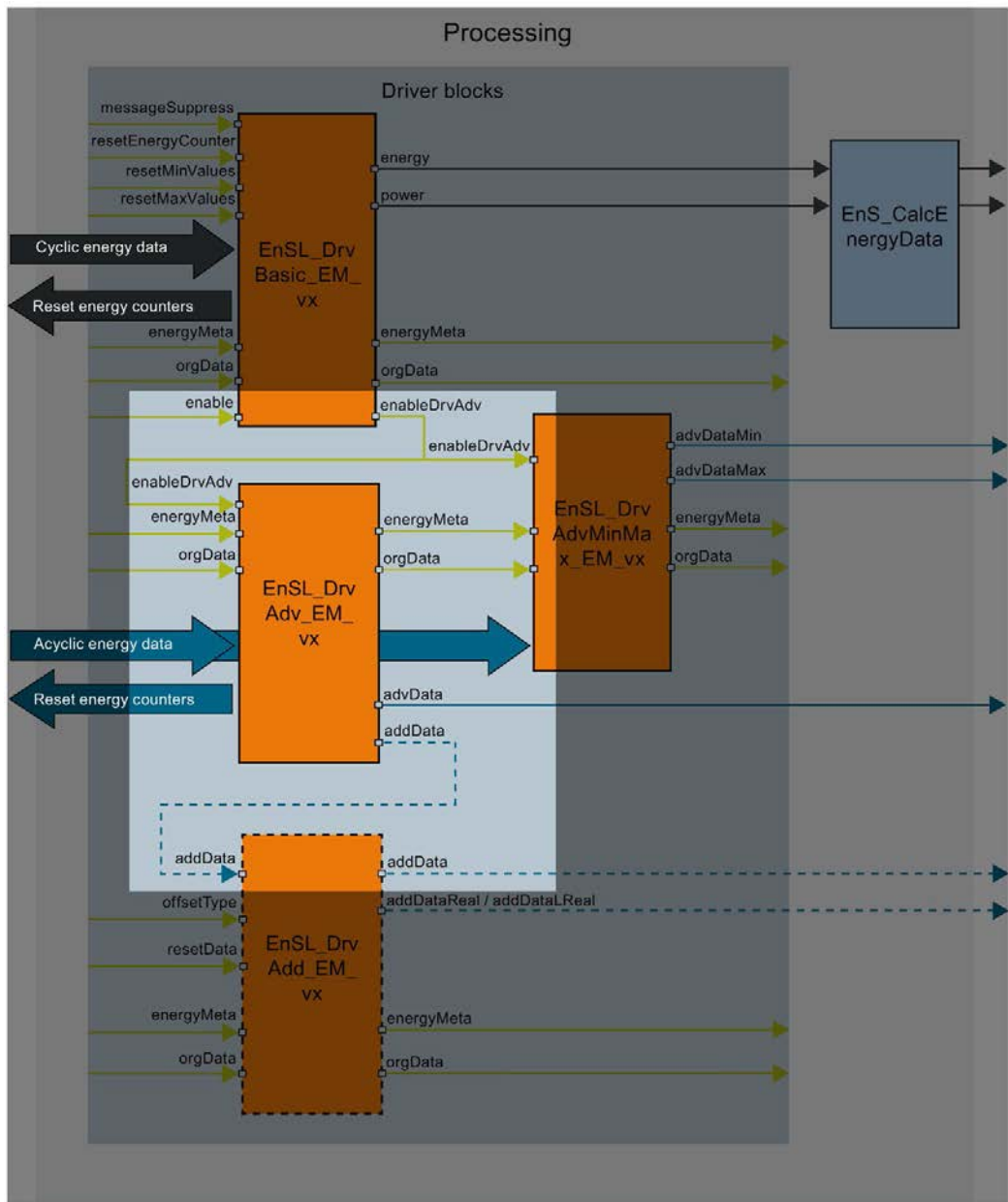

- Energy data via cyclic communication (process image)
- Energy data via acyclic communication (read/write data record)
- Energy Meter blocks
- Energy Suite blocks
- Parameter assignment data
- Required blocks
- Optional blocks

Note

The number of concurrently running RDREC calls is limited to 10 by the S7-1500 CPU.

The advanced energy values are made available at the output parameter "advData" and then transferred to the "EnS_EnergyDataAdv" function block.

Startup

The block has no startup characteristics.

Reaction to error

When an error occurs, the output parameter "error" is set. The "Status (Page 32)" parameter contains additional error information.

Alarms

The block has no signaling characteristics.

3.4.2 EnSL_DrvAdv_EM_vx parameter

The table below shows the parameters of the "EnSL_DrvAdv_EM_vx" block that are relevant for the Energy Suite:

Parameter	Declaration	Data type	Preassigned value	Description
enableDrvAdv	Input	BOOL	FALSE	Processing enable
advData	Output	EnS_typeEnergyAdv	-	Advanced measured data record
addData	Output	EnSL_typeAddEM	-	Data transfer for additional "EnSL_DrvAddReal_EM_vx" and "EnSL_DrvAddLReal_EM_vx" blocks
status	Output	WORD	16#00	Block status
orgData	InOut	EnS_typeOrgData	-	Organization data
energyMeta	InOut	EnS_typeEnergyMeta	-	Measuring point-specific data

3.4.3 Status parameter

The table below shows the error codes that are generated at the "status" output parameter when errors occur:

Error code (W#16#...)	Description	Solution
8002	"RDREC" advanced instruction timeout.	Additional information on error correction is available in the description of the advanced instruction "RDREC". The error code of the instruction is contained in the "statusRDREC" parameter.
8003	Reading data from Energy Meter has failed.	

3.5 EnSL_DrvAddReal_EM_vx: Acquire additional energy data of REAL type

3.5.1 Description of EnSL_DrvAddReal_EM_vx

Description

The "EnSL_DrvAddReal_EM_vx" function block makes available additional measured values of the type REAL(32-bit), which are provided by the "EnSL_DrvAdv_EM_vx" block. You can make available up to six different REAL values for each created instance of the function block for further processing.

The figure below shows the mode of operation of the "EnSL_DrvAddReal_EM_vx" block:

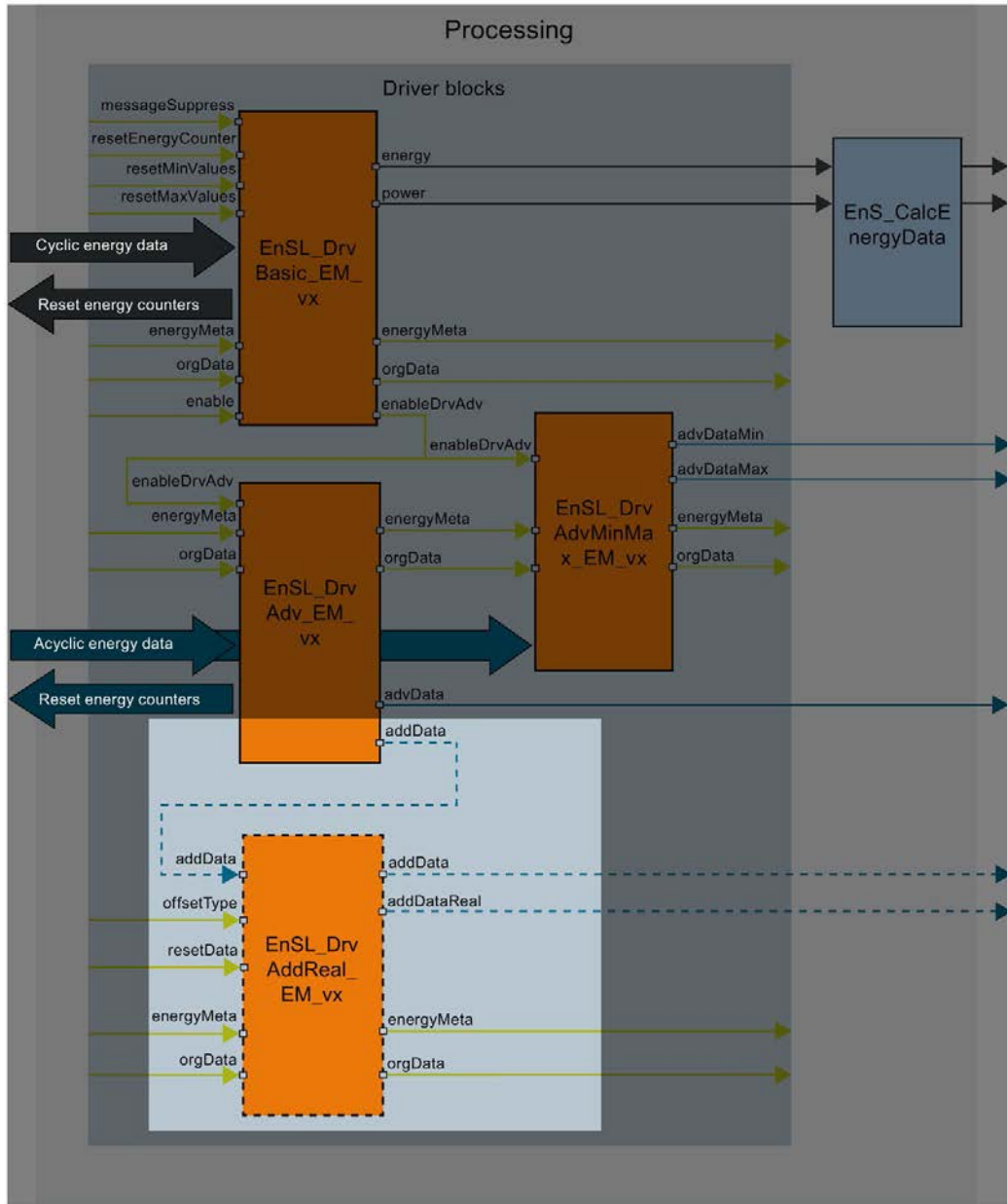

Startup

The block has no startup characteristics.

Reaction to error

When an error occurs, the output parameter "error" is set. The "Status (Page 38)" parameter contains additional error information.

Alarms

The block has no signaling characteristics.

3.5.2 EnSL_DrvAddReal_EM_vx parameter

The table below shows the parameters of the "EnSL_DrvAddReal_EM_vx" block that are relevant for the Energy Suite:

Parameter	Declaration	Data type	Preassigned value	Description
offsetType	Input	INT	0	Offset value for value in "energyMeta.typeAddValue"
addDataReal	Output	EnS_typeEnergyAddReal	-	Output of the values defined by "typeAddValue"
addData	InOut	EnSL_typeAddEM	-	Interface to EnSL_DrvAdv_EM_vx - must be connected
status	Output	WORD	16#00	Block status
energyMeta	InOut	EnS_typeEnergyMeta	-	Measuring-point-specific data

Settings at the "offsetType" parameter

The value at the input parameter "offsetType" refers to the index of the array element "typeAddValue" of the user-defined data type "EnS_typeEnergyMeta". The default setting is "0". Enter a numerical value at the "offsetType" parameter (valid values: 0 - 19). The numerical value represents the position of a lower-level array element of "typeAddValue". Up to six follow-on values starting at the specified numerical value are read from Energy Meter.

If this range contains an invalid value, the error "16#8013" is output.

Example of the "offsetType" parameter

The figure below shows the block call of "EnSL_DrvAddReal_EM_vx":

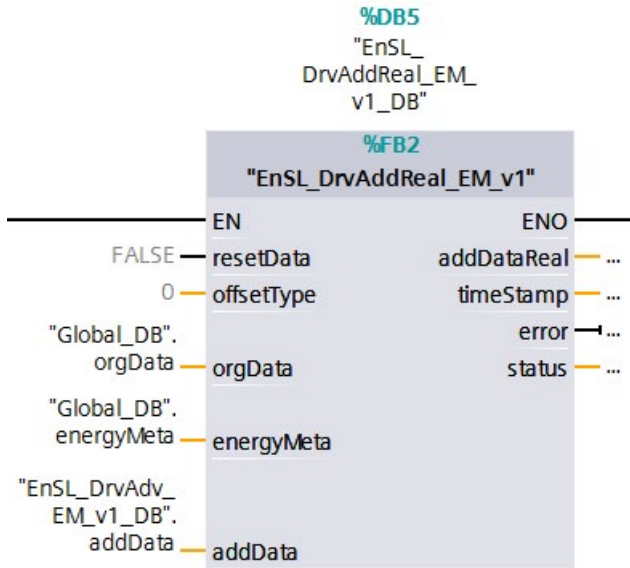

The value "0" is set at the "offsetType" parameter.

The figure below shows the entire "energyMeta.typeAddValue" array from the user-defined "EnS_typeEnergyMeta" data type:

Name	Data type	Start value
typeAddValue	Array[0..19] of UInt	
typeAddValue[0]	UInt	36
typeAddValue[1]	UInt	37
typeAddValue[2]	UInt	38
typeAddValue[3]	UInt	41
typeAddValue[4]	UInt	53
typeAddValue[5]	UInt	54
typeAddValue[6]	UInt	49
typeAddValue[7]	UInt	50
typeAddValue[8]	UInt	51
typeAddValue[9]	UInt	0
typeAddValue[10]	UInt	0
typeAddValue[11]	UInt	0
typeAddValue[12]	UInt	0
typeAddValue[13]	UInt	0
typeAddValue[14]	UInt	0
typeAddValue[15]	UInt	0
typeAddValue[16]	UInt	0
typeAddValue[17]	UInt	0
typeAddValue[18]	UInt	0
typeAddValue[19]	UInt	0

The "energyMeta.typeAddValue" array contains 20 elements of the type "UINT". Each of the elements has a start value which refers to the number of the measured value type. The measured value types can be arranged in any gap-less sequence in the "energyMeta.typeAddValue" array.

3.5 EnSL_DrvAddReal_EM_vx: Acquire additional energy data of REAL type

Because the "offsetType" parameter has the value "0", the following six measured values are written in the "REAL" data record:

energyMeta.typeAddValue[0] = Start value 36: Phase angle L1

energyMeta.typeAddValue[1] = Start value 37: Phase angle L2

energyMeta.typeAddValue[2] = Start value 38: Phase angle L3

energyMeta.typeAddValue[3] = Start value 41: Total active power L1L2L3

energyMeta.typeAddValue[4] = Start value 53: Amplitude unbalance for voltage

energyMeta.typeAddValue[5] = Start value 54: Amplitude unbalance for current

The six values are output at the "addDataReal" output of the "EnSL_DrvAddReal_EM_vx" block and written in the corresponding instance data block.

The figure below shows the offline view of the "addDataReal" output with the six "REAL" values:

Name	Data type	Start value
addDataReal	"EnS_typeEnergyAddReal"	
actValue	Array[0..5] of "EnS_typeAddValueReal"	
actValue[0]	"EnS_typeAddValueReal"	
value	Real	0.0
type	UInt	0
actValue[1]	"EnS_typeAddValueReal"	
value	Real	0.0
type	UInt	0
actValue[2]	"EnS_typeAddValueReal"	
actValue[3]	"EnS_typeAddValueReal"	
actValue[4]	"EnS_typeAddValueReal"	
actValue[5]	"EnS_typeAddValueReal"	

The table below shows the possible measured values in the "addDataReal.actValue" output structure:

Number	Measured value	Data type	Unit
36	Phase angle L1	REAL	°
37	Phase angle L2	REAL	°
38	Phase angle L3	REAL	°
39	Total apparent power L1L2L3	REAL	VAh
40	Total reactive power L1L2L3	REAL	varh
41	Total active power L1L2L3	REAL	Wh
42	Total reactive energy inflow L1L2L3	REAL	varh
43	Total reactive energy outflow L1L2L3	REAL	varh
44	Total active energy inflow L1L2L3	REAL	Wh
45	Total active energy inflow L1L2L3	REAL	Wh
53	Amplitude unbalance for voltage	REAL	%
54	Amplitude unbalance for current	REAL	%

See also

EnSL_DrvAddLReal_EM_vx parameter (Page 40)

3.5.3 Status parameter

The table below shows the error codes that are generated at the "status" output parameter when errors occur:

Error code (W#16#...)	Description	Solution
8013	Incorrect type This block supports only the "REAL" data type.	Select a "REAL" parameter, or read this parameter with the block "EnSL_DrvAddLReal_vx".
8014	Incorrect offset value The limits (0 - 19) of the "energyMeta.typeAddValue" array from which the six "REAL" values were read have been exceeded.	Reduce the offset value.

3.6 EnSL_DrvAddLReal_EM_vx: Acquire additional energy data of REAL type

3.6.1 Description of EnSL_DrvAddLReal_EM_vx

Description

The "EnSL_DrvAddLReal_EM_vx" function block makes available additional energy value of the type LREAL (64-bit), which are provided by the "EnSL_DrvAdv_EM_vx" block. You can make available for further use up to three different REAL values per created instance of the function block.

3.6 EnSL_DrvAddLReal_EM_vx: Acquire additional energy data of REAL type

The figure below shows the mode of operation of the "EnSL_DrvAddLReal_EM_vx" block:

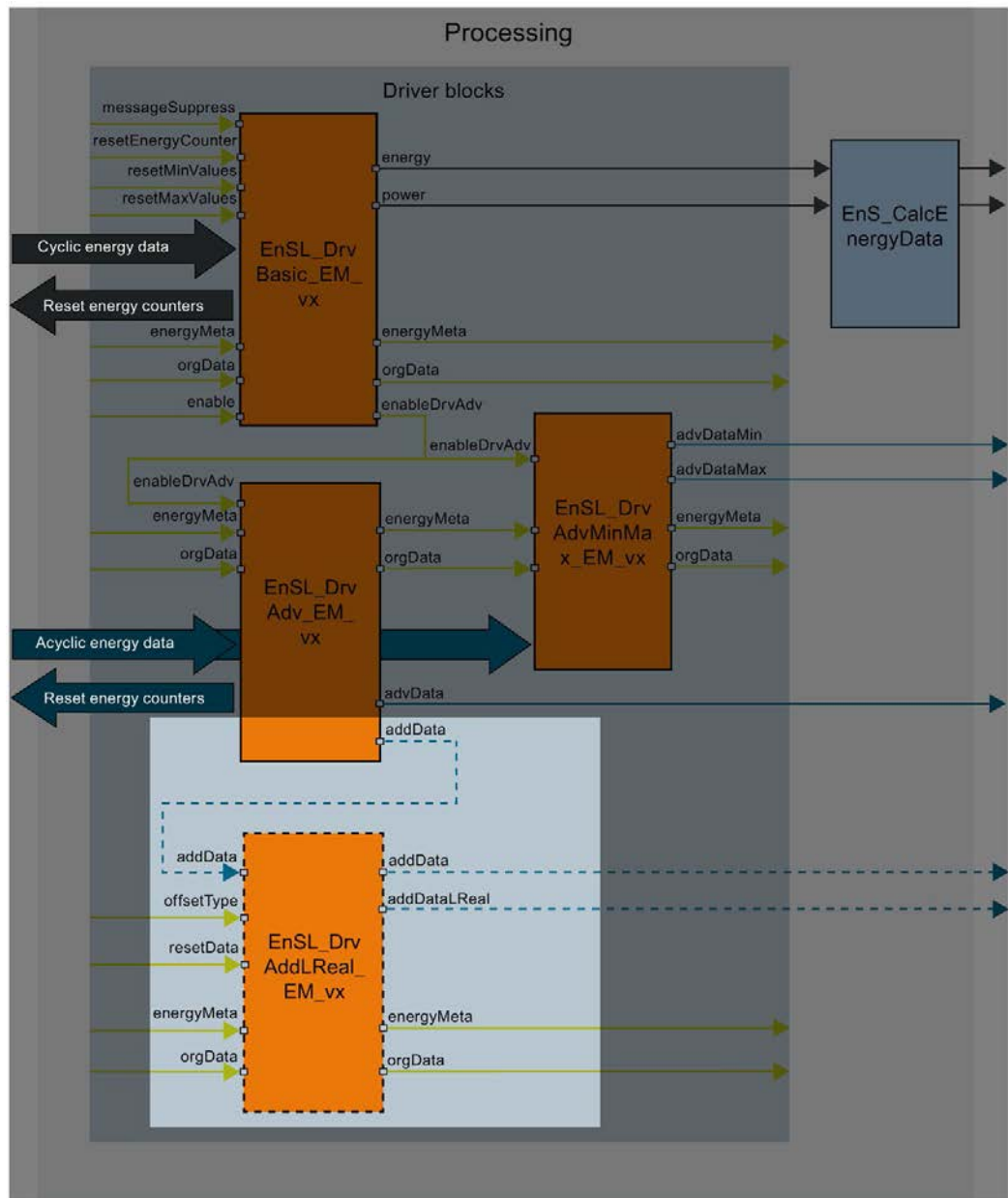

- Energy data via acyclic communication (read/write data record)
- Energy Meter blocks
- Parameter assignment data
- Required blocks
- Optional blocks

Startup

The block has no startup characteristics.

Reaction to error

When an error occurs, the output parameter "error" is set. The "Status (Page 41)" parameter contains additional error information.

Alarms

The block has no signaling characteristics.

3.6.2 EnSL_DrvAddLReal_EM_vx parameter

The table below shows the parameters of "EnSL_DrvAddLReal_EM_vx" block:

Parameter	Declaration	Data type	Preassigned value	Description
offsetType	Input	INT	0	Offset value for value in "energyMeta.typeAddValue"
addDataLReal	Output	EnS_typeEnergyAddLReal	-	Output of the values defined by "typeAddValue"
addData	InOut	EnSL_typeAddEM	-	Interface to "EnSL_DrvAdv_EM_vx" - must be connected
status	Output	WORD	16#00	Block status
energyMeta	InOut	EnS_typeEnergyMeta	-	Measuring-point-specific data

Settings at the "offsetType" parameter

The value at the "offsetType" input parameter refers to the "typeAddValue" value in the user-defined "EnS_typeEnergyMeta" data type. The default setting is "0". Enter a numerical value at the parameter "offsetType". The numerical value represents the position of a lower-level element of "typeAddValue". Up to three follow-on values are read from the Energy Meter starting at the specified numerical value.

If this range contains an invalid value, the error "16#8013" is output.

You can find an example for using the parameter "offsetType" in the section "EnSL_DrvAddReal_EM_vx parameter (Page 35)".

The table below shows the possible measured values in the "addDataLReal.actValue" output structure:

Value	Meaning	Data type	Unit
49	Total reactive energy inflow L1L2L3	LREAL	varh
50	Total reactive energy outflow L1L2L3	LREAL	varh
51	Total active energy inflow L1L2L3	LREAL	Wh
52	Total active energy inflow L1L2L3	LREAL	Wh

3.6.3 Status parameter

The table below shows the error codes that are generated at the "status" output parameter when errors occur:

Error code (W#16#...)	Description	Solution
8013	Incorrect type This block supports only the "LREAL" data type.	Select a "LREAL" parameter, or read this parameter with the block "EnSL_DrvAddReal_vx".
8014	Incorrect offset value	Reduce the offset value.

3.7 EnSL_DrvAdvMinMax_EM_vx: Acquire advanced minimum and maximum values

3.7.1 Description of EnSL_DrvAdvMinMax_EM_vx

The "EnSL_DrvAdvMinMax_EM_vx" block uses the acyclic data transfer of the Advanced energy data from Energy Meter. The advanced minimum and maximum values (e.g. minimum current, minimum voltage, minimum frequency) are transferred to the output structures at the "EnS_EnergyDataAdvMinMax" function block.

3.7 EnSL_DrvAdvMinMax_EM_vx: Acquire advanced minimum and maximum values

The figure below shows the mode of operation of the "EnSL_DrvAdvMinMax_EM_vx" block:

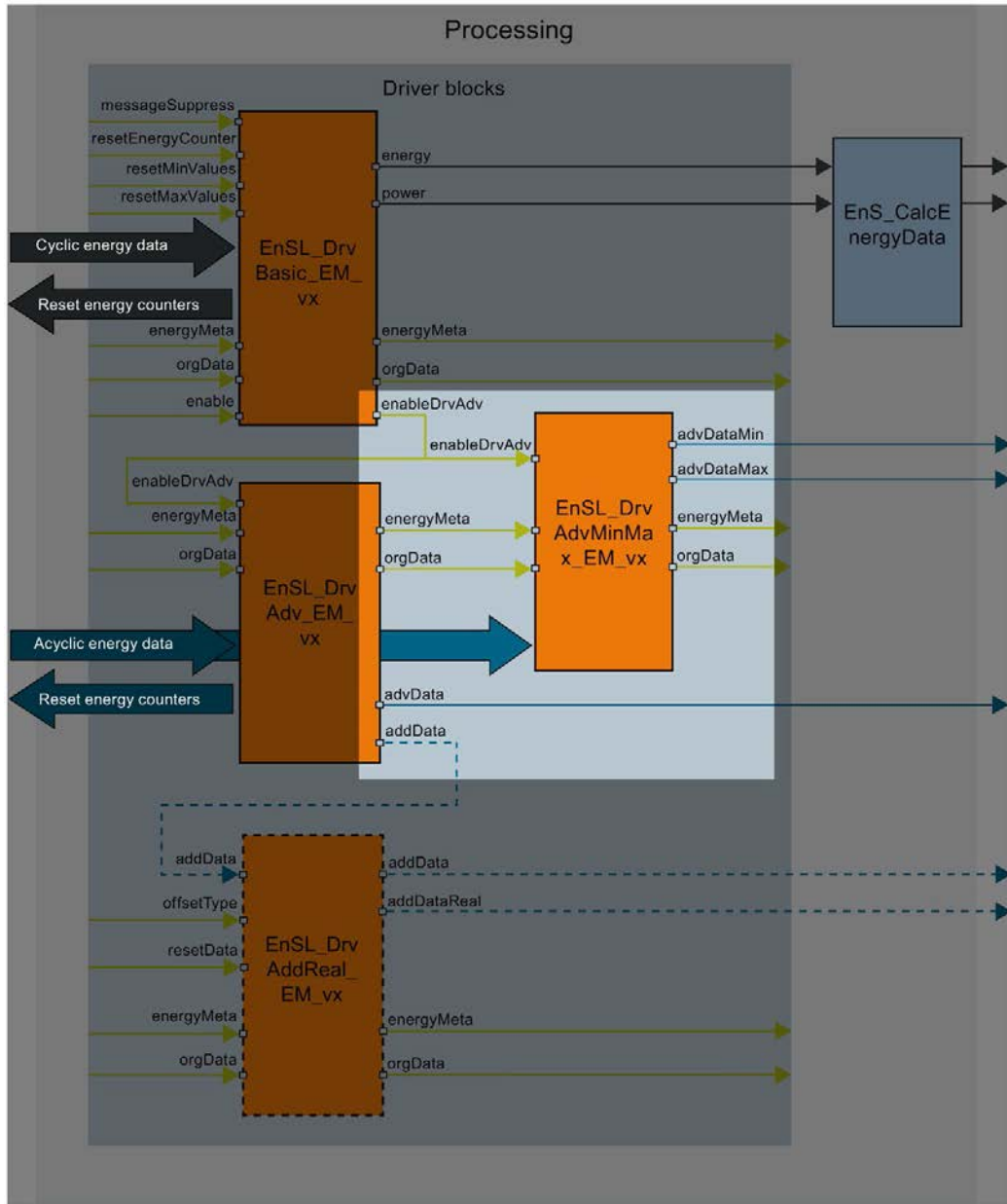

- Energy data via cyclic communication (process image)
- Energy data via acyclic communication (read/write data record)
- Parameter assignment data
- Energy Meter blocks
- Energy Suite blocks

3.7.2 EnSL_DrvAdvMinMax_EM_vx parameter

The table below shows the parameters of the "EnSL_DrvAdvMinMax_EM_vx" block that are relevant for the Energy Suite:

Parameter	Declaration	Data type	Preassigned value	Description
enableDrvAdv	Input	BOOL	FALSE	TRUE = Processing enable Must be linked to the "EnSL_DrvBasic_EM_vx" function block. When the connection to the Energy Meter is interrupted, all acyclic communicating driver blocks are disabled.
advDataMin	Output	EnS_typeEnergyAdv	-	Advanced measurement data record with minimum values Transferred to the "EnS_EnergyDataAdvMinMax" function block.
advDataMax	Output	EnS_typeEnergyAdv	-	Advanced measurement data record with maximum values Transferred to the "EnS_EnergyDataAdvMinMax" function block.
status	Output	WORD	-	Error status information (Page 43)
orgData	InOut	EnS_typeOrgData	-	Organization data
energyMeta	InOut	EnS_typeEnergyMeta	-	Measuring-point-specific data

3.7.3 Status parameter

The table below shows the error codes which are output when errors occur at the "status" output parameter of the block of the "EnSL_DrvAdvMinMax_EM_vx" block:

Error code (W#16#...)	Description	Solution
8002	"RDREC" advanced instruction timeout	Additional information on error correction is available in the description of the advanced instruction "RDREC". The error code of the instruction is contained in the "statusRDREC" parameter.
8003	Reading data from Energy Meter has failed.	

3.8 User-defined data types (UDTs) from Energy Meter

3.8.1 EnSL_typeAddEM

3.8.1.1 Description of EnSL_typeAddEM

The PLC data type "EnSL_typeAddEM" contains measured values which are transferred to the blocks "EnSL_DrvAddReal_EM_vx" and/or "EnSL_DrvAddLReal_EM_vx".

3.8.1.2 Structure of EnSL_typeAddEM

The table below shows the parameters of the PLC data type "EnSL_typeAddEM":

Parameter	Data type	Preassigned value	Description
ampUnbalVoltage	BYTE	-	Amplitude unbalance for voltage
ampUnbalCurrent	WORD	-	Amplitude unbalance for current
phaseAngle1	REAL	0.0	Phase angle L1
phaseAngle2	REAL	0.0	Phase angle L2
phaseAngle3	REAL	0.0	Phase angle L3
totAppEnergy	REAL	0.0	Total apparent energy L1L2L3
totReactEnergy	REAL	0.0	Total reactive energy L1L2L3
totActEnergy	REAL	0.0	Total active energy L1L2L3
totReactEnergyImport	REAL	0.0	Total reactive energy inflow L1L2L3
totReactEnergyExport	REAL	0.0	Total reactive energy outflow L1L2L3
totActEnergyImport	REAL	0.0	Total active energy inflow L1L2L3
totActEnergyExport	REAL	0.0	Total active energy inflow L1L2L3
totReactEnergyImp	LREAL	0.0	Total reactive energy inflow L1L2L3
totReactEnergyExp	LREAL	0.0	Total reactive energy outflow L1L2L3
totActEnergyImp	LREAL	0.0	Total active energy inflow L1L2L3
totActEnergyExp	LREAL	0.0	Total active energy inflow L1L2L3
status	WORD	-	Status of the process value
timestamp	DATE_AND_TIME	0	Time stamp

SENTRON PAC3200/4200

4.1 Description of SENTRON PAC3200/4200

SENTRON PAC3200/PAC4200, referred to as "PAC3200/4200" in the following, is a multifunction measuring device for measuring and displaying relevant system parameters in the low-voltage power distribution. PAC3200/4200 makes available the measured energy data (e.g. power, energy, voltage, current) at its PROFINET interface via the Switched Ethernet PROFINET communication module. The energy data can be read by the connected SIMATIC controller (for example, S7-1500) at the PROFINET interface. The following section describes the driver blocks that enable simplified and standardized communication.

Integration in TIA Portal hardware catalog

PAC3200/4200 can be connected via PROFINET IO in the TIA Portal. To configure the measurement hardware, you need a generic station description file (PROFINET IO: GSDML file). The GSDML file is designed only for use of the corresponding communication module with the relevant model of the PAC3200/4200.

You can find the corresponding general station description file for PAC3200/4200 in the Siemens Industry Online Support.

(<https://support.industry.siemens.com/cs/document/59840946/gsdml-file%3A-switched-ethernet-profinet-module?dti=0&lc=en-US>)

A specific hardware configuration has to be set in order to use PAC3200/4200 as energy data source in Energy Suite. You can find the required hardware configuration in the section "Hardware Configuration and Parameter Assignment (Page 48)".

Application

The driver blocks for PAC3200/4200 are contained in the global library "Energy Support Library".

The table below shows the driver blocks of PAC3200/4200:

Name	Function
EnSL_DrvBasic_PAC_vx	Driver block for PAC3200/4200 for basic energy data
EnSL_DrvAdv_PAC_vx	Driver block for PAC3200/4200 for advanced energy data
EnSL_DrvAdvMinMax_PAC_vx	Driver block for PAC3200/4200 for advanced minimum and maximum values
EnSL_DrvAddLReal_PAC_vx	Driver block for PAC3200/4200 for advanced energy data of type LREAL
EnSL_DrvAddREAL_PAC_vx	Driver block for PAC3200/4200 for advanced energy data of type REAL

4.2 Mode of operation of the driver blocks for SENTRON PAC3200/4200

The driver blocks read the energy data from PAC3200/4200 via cyclic or acyclic communication. You can find the general overview of the energy data processing in the section "Energy data processing based on the "IPO" principle (Page 14)".

4.2 Mode of operation of the driver blocks for SENTRON PAC3200/4200

The figure below shows the structure and the data flow of the PAC3200/4200 blocks:

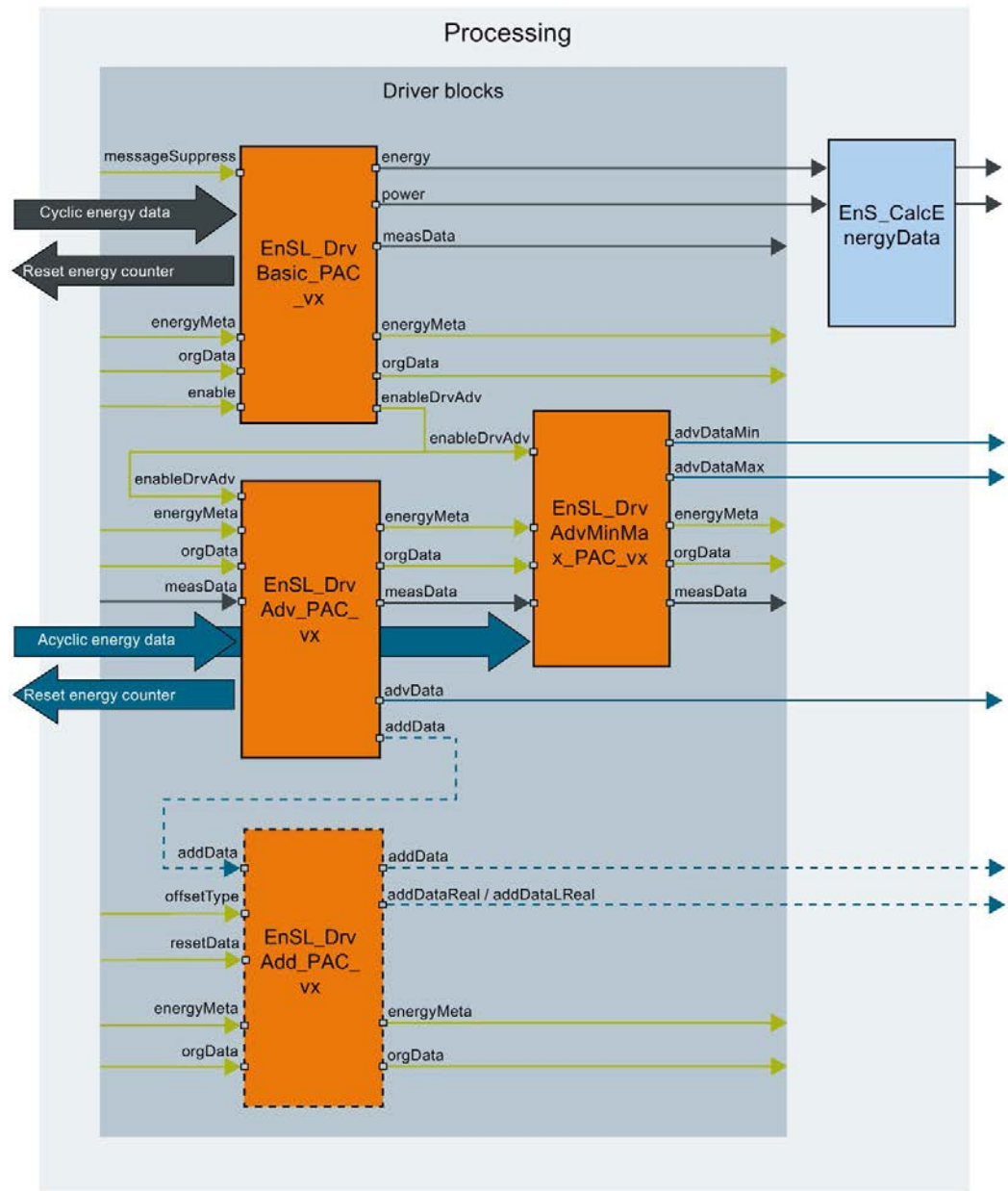

- Energy data via cyclic communication (process image)
- Energy data via acyclic communication (read/write data record)
- Parameter assignment data
- SENTRON PAC3200/PAC4200 blocks
- Energy Suite blocks
- Required blocks
- Optional blocks

4.3 EnSL_DrvBasic_PAC_vx: Acquire basic energy data

4.3.1 Description of EnSL_DrvBasic_PAC_vx

The "EnSL_DrvBasic_PAC_vx" block reads the basic energy data (momentary active energy and momentary active power) PAC3200/4200 and transmits this data to the "EnS_CalcEnergyData" and "EnSL_DrvAdv_PAC_vx" blocks.

The energy counters and the minimum and maximum values can be reset with the block using a positive edge at the corresponding input parameters.

A command is automatically executed in the startup of the block to switch to tariff 1. The block supports only the energy data of tariff 1.

The figure below shows the mode of operation of the "EnSL_DrvBasic_PAC_vx" block:

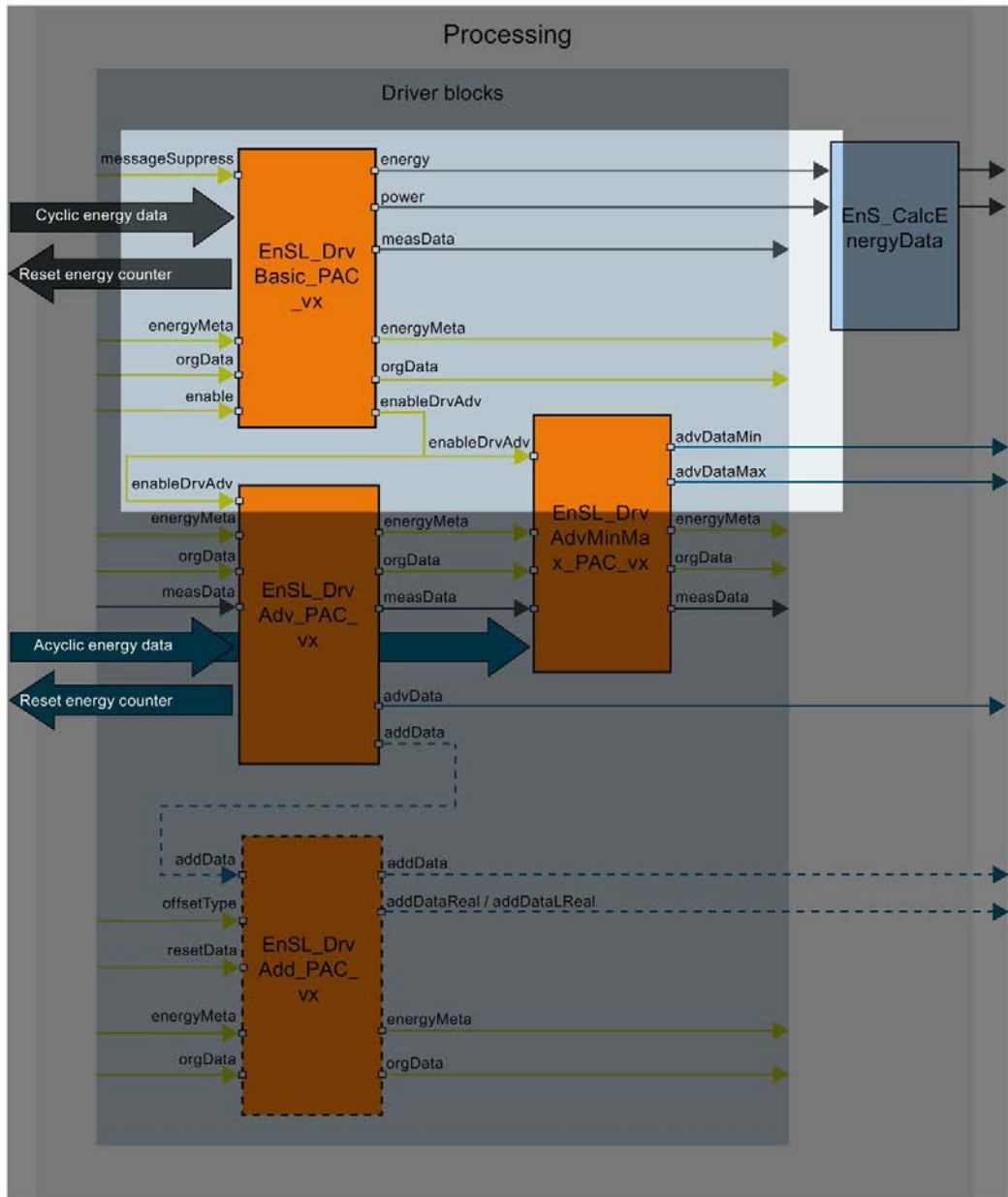

- Energy data via cyclic communication (process image)
- Energy data via acyclic communication (read/write data record)
- Parameter assignment data
- SENTRON PAC blocks
- Energy Suite blocks

Hardware configuration and parameter assignment

The measurement data are read cyclically by the PLC from the PAC3200/4200. The "EnSL_DrvBasic_PAC_vx" block requires the HW ID of the following submodule for this purpose:

- PMD diagnostics and status ①
- Total active power ②
- Active energy inflow tariff 1 (D) ③
- Active energy outflow tariff 1 (D) ④
- Control bytes ⑤

During the generation of the energy program, the hardware IDs are read and saved in "EnS_EnergyDataBasic.energyMeta".

The figure below show this configuration of the PAC3200/4200 in the device view:

Module	Rack	Slot	I address	Q address
▼ PAC4200	0	0		
▶ PN-IO	0	0 X1		
① PMD Diagnostics & Status	0	1	24...27	
② Total Active Power	0	2	28...31	
③ Act Energy Imp Tar 1(D)	0	3	32...39	
④ Act Energy Exp Tar 1(D)	0	4	40...47	
⑤ Control Bytes	0	5		2...3

4.3.2 EnSL_DrvBasic_PAC_vx parameter

The table below shows the parameters of the "EnSL_DrvBasic_PAC_vx" block that are relevant for the Energy Suite:

Parameter	Declaration	Data type	Preassigned value	Description
enable	Input	BOOL	FALSE	TRUE = Processing enable
messageSup- sageSup- press	Input	BOOL	FALSE	Message suppression
energy	Output	EnS_typeEnergyCounter	-	Momentary value of the active energy counter
power	Output	EnS_typeAnalogValue	-	Momentary value of the active power
measData	Output	EnSL_typeAdvPAC (Page 67)	-	Cyclic measured values that are read from the PAC3200/4200 and transferred to the "EnSL_DrvAdv_PAC_vx" block as advanced energy data.
status	Output	WORD	-	Error status information (Page 52)
orgData	InOut	EnS_typeOrgData	-	Organization data
energyMeta	InOut	EnS_typeEnergyMeta	-	Measuring-point-specific data Extract of relevant parameters: <ul style="list-style-type: none"> energyMeta.mode energyMeta.normFactorIn energyMeta.inputType energyMeta.connectionType energyMeta.overflowCntValue
enableDrvAdv	InOut	BOOL	FALSE	TRUE = Processing enable Must be linked to the "EnSL_DrvAdv_PAC_vx" and/or "EnSL_DrvAdvMinMax_PAC_vx" block. If the connection to the PAC3200/4200 is interrupted (status 16#8001), all acyclic communicating driver blocks are disabled.
deviceState	InOut	DWORD	-	Status of PAC3200/4200

4.3.3 Status parameter

The table below shows the error codes which are output when errors occur at the "status" output parameter of the "EnSL_DrvBasic_PAC_vx" block:

Error code (W#16#...)	Description	Solution
8001	Connection with PAC3200/4200 is interrupted / extended instruction "GETIO" has failed	Establish a connection to the measuring instrument. You can find additional information on error correction in the extended instruction "GETIO".
8008	"GETIO" and "SETIO" extended instructions have failed	You can find additional information on error correction in the description of the extended instruction "GETIO" and "SETIO". The error code of the instruction is contained in the parameter "statusGETIO" and "statusSETIO".
8011	Energy flow direction invalid	Enter a valid value at the parameter for energy flow direction
8020	The measuring instrument returns an error. Current is above 1.2 times the measuring range (for example, when the starting current of a motor is high) or the voltage is outside the measuring range.	Check the setting of the measuring current or the measuring voltage in PAC3200/4200 or use the appropriate current transformer or voltage transformer. At the same time, note the current-carrying capacity.

4.3.4 Alarms

If the connection to the PAC3200/4200 is interrupted (status 16#8xxx), an alarm is output via the advanced instruction "Program_Alarm".

The table below shows the alarms of the "EnSL_DrvBasic_PAC_vx" block:

Alarm block	Alarm text	Alarm class
Program_Alarm	Connection lost	With acknowledgment

The alarm can be changed and configured in WinCC.

When the driver block is used in Energy Suite the alarm can be suppressed centrally via the "EnS_Organization" function block.

4.4 EnSL_DrvAdv_PAC_vx: Acquire advanced energy data

4.4.1 Description of EnSL_DrvAdv_PAC_vx

The "EnSL_DrvAdv_PAC_vx" block uses the acyclic data transfer of the Advanced Energy data from PAC3200/4200. The advanced energy data (current, voltage, frequency etc.) are transferred to the output structure at the Energy Suite "EnS_EnergyDataAdv" function block.

The figure below shows the mode of operation of the "EnSL_DrvAdv_PAC_vx" block:

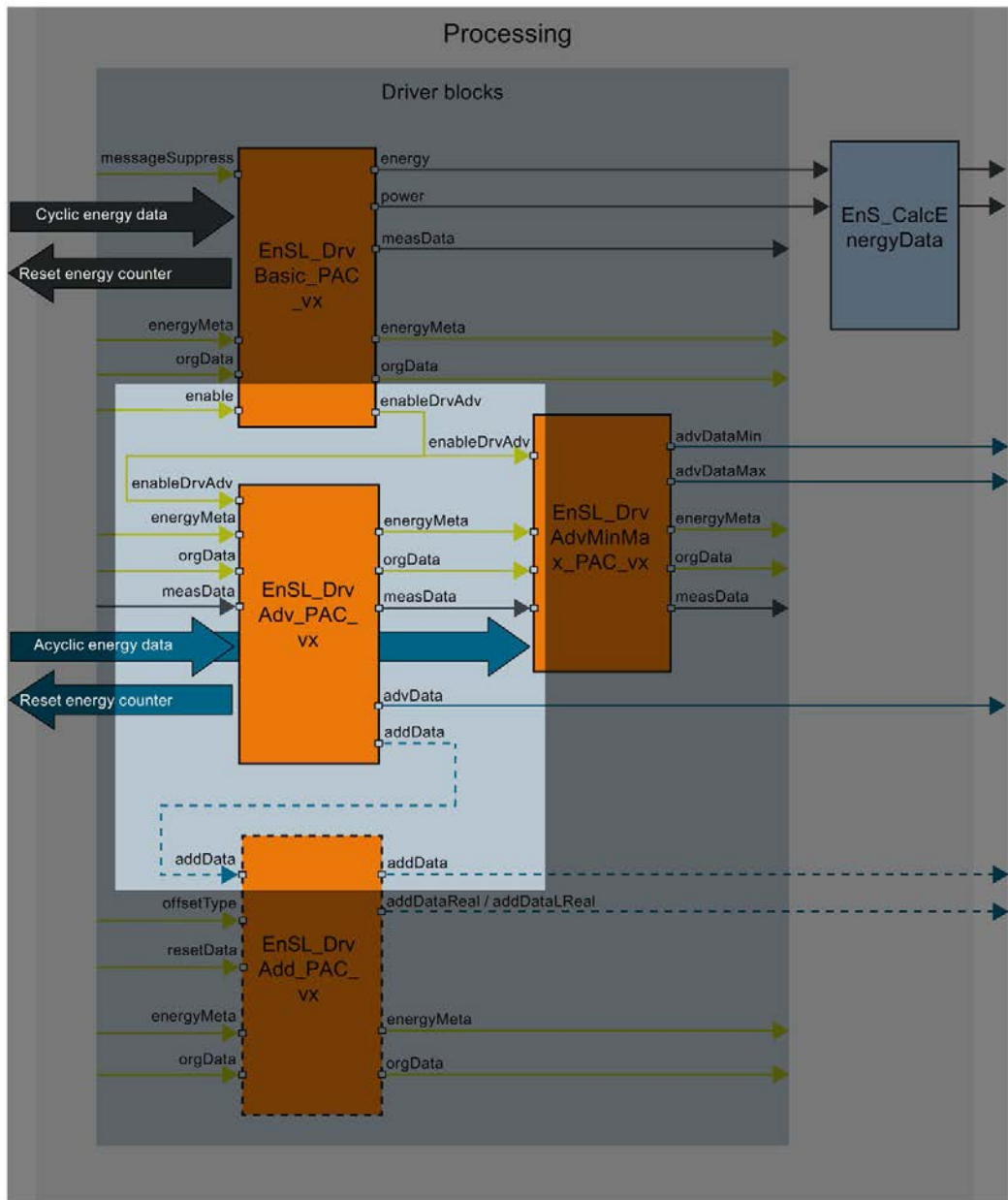

- Energy data via cyclic communication (process image)
- Energy data via acyclic communication (read/write data record)
- SENTRON PAC blocks
- Parameter assignment data
- Required blocks
- Optional blocks

4.4.2 EnSL_DrvAdv_PAC_vx parameter

The table below shows the parameters of the "EnSL_DrvAdv_PAC_vx" block that are relevant for the Energy Suite:

Parameter	Declaration	Data type	Default setting	Description
enableDrvAdv	Input	BOOL	FALSE	TRUE = Processing enable Must be linked to the "EnSL_DrvBasic_PAC_vx" function block. When the connection to the PAC3200/4200 is interrupted (status 16#8004), all acyclic communicating driver blocks are disabled.
addData	Output	EnSL_typeAddSENT RON (Page 68)	-	Data transfer for additional "EnSL_DrvAddReal_PAC_vx" and "EnSL_DrvAddLReal_PAC_vx" blocks. Contains: <ul style="list-style-type: none"> • 20 "LREAL" values • 20 "LREAL" values • 20 measured value addresses • 20 measured value lengths
advData	Output	EnS_typeEnergyAdv	-	Advanced measurement data record Transferred to the "EnS_EnergyDataAdv" function block.
status	Output	WORD	-	Error status information (Page 55)
measData	InOut	EnSL_typeAdvPAC (Page 67)		Cyclic measured values that are read from the PAC3200/PAC4200 and transferred to the "EnSL_DrvAdv_PAC_vx" block as advanced energy data.
energyMeta	InOut	EnS_typeEnergyMeta	-	Measuring-point-specific data

4.4.3 Status parameter

The table below shows the error codes which are output when errors occur at the "status" output parameter of the "EnSL_DrvAdv_PAC_vx" block:

Error code (W#16#...)	Description	Solution
8002	"RDREC" advanced instruction timeout	Additional information on error correction is available in the description of the advanced instruction "RDREC".
8003	Reading data from PAC3200/4200 has failed.	The error code of the instruction is contained in the "statusRDREC" parameter.
8004	"WRREC" advanced instruction timeout	Additional information on error correction is available in the description of the advanced instruction "WRREC".
8005	Writing data to PAC3200/4200 has failed.	The error code of the instruction is contained in the "statusWRREC" parameter.
8020	The measuring instrument returns an error. Current is above 1.2 times the measuring range (for example, when the starting current of a motor is high) or the voltage is outside the measuring range.	Check the setting of the measuring current or the measuring voltage in PAC3200/4200 or use the appropriate current transformer or voltage transformer. At the same time, note the current-carrying capacity.

4.5 EnSL_DrvAdvMinMax_PAC_vx: Acquire advanced minimum and maximum values

4.5.1 Description of EnSL_DrvAdvMinMax_PAC_vx

The "EnSL_DrvAdvMinMax_PAC_vx" block uses the acyclic data transfer of the Advanced Energy data from PAC3200/4200. The advanced minimum and maximum values (minimum current, minimum voltage, minimum frequency, etc.) are transferred to the output structures at the "EnS_EnergyDataAdvMinMax" function block.

4.5 EnSL_DrvAdvMinMax_PAC_vx: Acquire advanced minimum and maximum values

The figure below shows the mode of operation of the "EnSL_DrvAdvMinMax_PAC_vx" block:



- Energy data via cyclic communication (process image)
- Energy data via acyclic communication (read/write data record)
- Parameter assignment data
- SENTRON PAC blocks
- Energy Suite blocks

4.5.2 EnSL_DrvAdvMinMax_PAC_vx parameter

The table below shows the parameters of the "EnSL_DrvAdvMinMax_PAC_vx" block that are relevant for the Energy Suite:

Parameter	Declaration	Data type	Preassigned value	Description
enableDrvAdv	Input	BOOL	FALSE	TRUE = Processing enable Must be linked to the "EnSL_DrvBasic_PAC_vx" function block. When the connection to the PAC3200/PAC4200 is interrupted, all acyclic communicating driver blocks are disabled.
advDataMin	Output	EnS_typeEnergyAdv	-	Advanced measurement data record with minimum values Transferred to the "EnS_EnergyDataAdvMinMax" function block.
advDataMax	Output	EnS_typeEnergyAdv	-	Advanced measurement data record with maximum values Transferred to the "EnS_EnergyDataAdvMinMax" function block.
status	Output	WORD	-	Error status information (Page 58)
measData	InOut	EnSL_typeAdvPAC (Page 67)	-	Cyclic measured values that are read from the PAC3200/4200 and transferred to the "EnSL_DrvAdvMinMax_PAC_vx" block as advanced energy data.
orgData	InOut	EnS_typeOrgData	-	Organization data
energyMeta	InOut	EnS_typeEnergyMeta	-	Measuring-point-specific data

4.5.3 Status parameter

The table below shows the error codes which are output when errors occur at the "status" output parameter of the "EnSL_DrvAdvMinMax_PAC_vx" block:

Error code (W#16#...)	Description	Solution
8002	"RDREC" advanced instruction timeout	Additional information on error correction is available in the description of the advanced instruction "RDREC".
8003	Reading data from PAC3200/4200 has failed.	The error code of the instruction is contained in the "statusRDREC" parameter.
8004	"WRREC" advanced instruction timeout	Additional information on error correction is available in the description of the advanced instruction "WRREC".
8005	Writing data to PAC3200/4200 has failed.	The error code of the instruction is contained in the "statusWRREC" parameter.
8020	The measuring instrument returns an error. Current is above 1.2 times the measuring range (for example, when the starting current of a motor is high) or the voltage is outside the measuring range.	Check the setting of the measuring current or the measuring voltage in PAC3200/4200 or use the appropriate current transformer or voltage transformer. At the same time, note the current-carrying capacity.

4.6 EnSL_DrvAddReal_PAC_vx: Acquire additional energy data of the REAL type

4.6.1 Description of EnSL_DrvAddReal_PAC_vx

The "EnSL_DrvAddReal_PAC_vx" block makes available Additional measured values of the type REAL (32 Bit) via acyclic communication. You can read up to six different REAL values for each created instance of the block from PAC3200/4200.

4.6 EnSL_DrvAddReal_PAC_vx: Acquire additional energy data of the REAL type

The figure below shows the mode of operation of the "EnSL_DrvAddReal_PAC_vx" block:

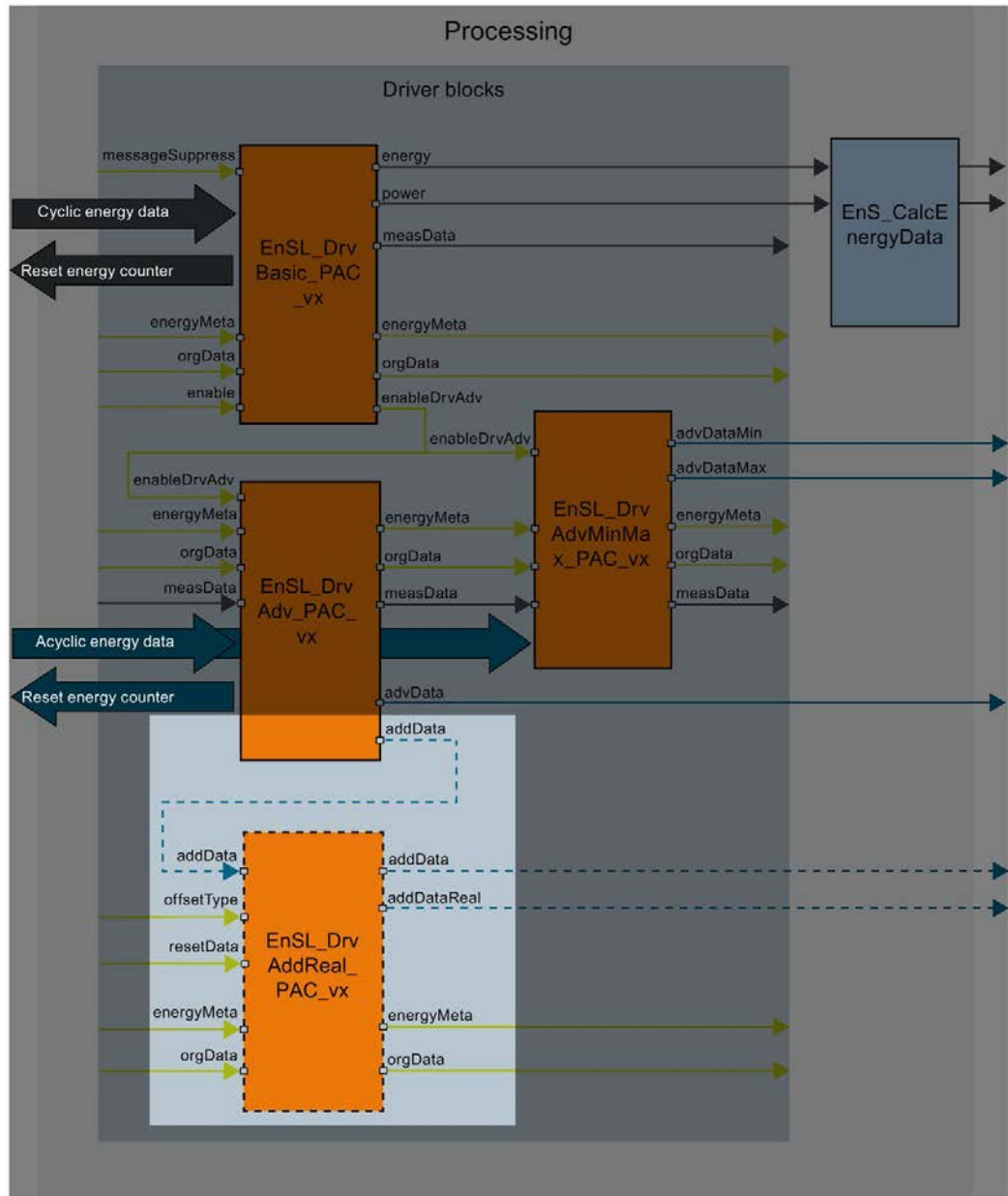

- Energy data via acyclic communication (read/write data record)
- Parameter assignment data
- SENTRON PAC blocks
- Required blocks
- Optional blocks

4.6.2 EnSL_DrvAddReal_PAC_vx parameter

The table below shows the parameters of the "EnSL_DrvAddReal_PAC_vx" block that are relevant for the Energy Suite:

Parameter	Declaration	Data type	Preasigned value	Description
offsetType	Input	UINT	0	Offset value in the "energyMeta.typeAddValue" array Specifies the numerical value (number) starting at which the six follow-on "REAL" values are read from the "energyMeta.typeAddValue" array.
addDataReal	Output	EnS_typeEnergyAddReal	-	Momentary "REAL" data record Contains up to six "REAL" values which are made available in the "addDataReal.actValue" output structure.
status	Output	WORD	-	Error status information (Page 64)
energyMeta	InOut	EnS_typeEnergyMeta	-	Measuring-point-specific data
addData	InOut	EnSL_typeAddSENTRON (Page 68)	-	Data transfer from the "EnSL_DrvAdv_PAC_vx" block Contains: <ul style="list-style-type: none"> • 20 "LREAL" values • 20 measured value addresses • 20 measured value lengths

Settings at the "offsetType" parameter

The value at the input parameter "offsetType" refers to the index of the array element "typeAddValue" of the user-defined data type "EnS_typeEnergyMeta". The default setting is "0". Enter a numerical value at the "offsetType" parameter (valid values: 0 - 19). The numerical value represents the position of a lower-level array element of "typeAddValue". Up to six follow-on values starting at the specified numerical value are read from PAC3200/4200.

Example of the "offsetType" parameter

The figure below shows the block call of "EnSL_DrvAddReal_PAC_vx":

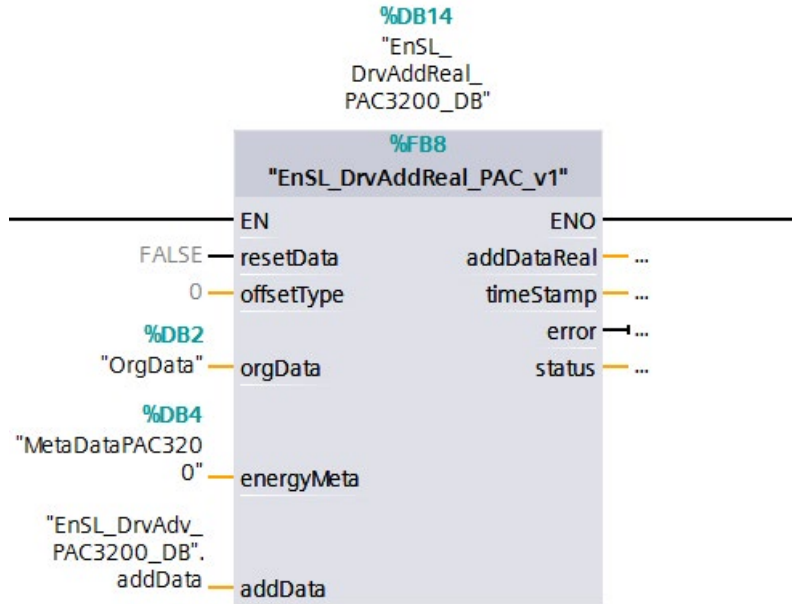

The value "0" is set at the "offsetType" parameter.

The figure below shows the entire "energyMeta.typeAddValue" array from the user-defined "EnS_typeEnergyMeta" data type:

Name	Data type	Start value
typeAddValue	Array[0..19] of UInt	
typeAddValue[0]	UInt	22
typeAddValue[1]	UInt	29
typeAddValue[2]	UInt	30
typeAddValue[3]	UInt	31
typeAddValue[4]	UInt	53
typeAddValue[5]	UInt	54
typeAddValue[6]	UInt	49
typeAddValue[7]	UInt	50
typeAddValue[8]	UInt	51
typeAddValue[9]	UInt	0
typeAddValue[10]	UInt	0
typeAddValue[11]	UInt	0
typeAddValue[12]	UInt	0
typeAddValue[13]	UInt	0
typeAddValue[14]	UInt	0
typeAddValue[15]	UInt	0
typeAddValue[16]	UInt	0
typeAddValue[17]	UInt	0
typeAddValue[18]	UInt	0
typeAddValue[19]	UInt	0

4.6 EnSL_DrvAddReal_PAC_vx: Acquire additional energy data of the REAL type

The "energyMeta.typeAddValue" array contains 20 elements of the type "UINT". Each of the elements has a start value which refers to the number of the measured value type. The measured value types can be arranged in any gap-less sequence in the "energyMeta.typeAddValue" array.

Because the "offsetType" parameter has the value "0", the following six measured values are written in the "REAL" data record:

- energyMeta.typeAddValue[0] = Start value 22: THD-R voltage L1 (-L2)
- energyMeta.typeAddValue[1] = Start value 29: Mean voltage UPh-N
- energyMeta.typeAddValue[2] = Start value 30: Mean voltage UPh-Ph
- energyMeta.typeAddValue[3] = Start value 31: Mean current Ph-Ph
- energyMeta.typeAddValue[4] = Start value 53: Amplitude unbalance for voltage
- energyMeta.typeAddValue[5] = Start value 54: Amplitude unbalance for current

The six values are output at the "addDataReal" output of the block "EnSL_DrvAddReal_PAC_vx" and written in the corresponding instance data block.

The figure below shows the offline view of the "addDataReal" output with the six "REAL" values:

Name	Data type	Start value
addDataReal	"EnS_typeEnergyAddReal"	
actValue	Array[0..5] of "EnS_typeAddValueReal"	
actValue[0]	"EnS_typeAddValueReal"	
value	Real	0.0
type	UInt	0
actValue[1]	"EnS_typeAddValueReal"	
value	Real	0.0
type	UInt	0
actValue[2]	"EnS_typeAddValueReal"	
actValue[3]	"EnS_typeAddValueReal"	
actValue[4]	"EnS_typeAddValueReal"	
actValue[5]	"EnS_typeAddValueReal"	

4.6 EnSL_DrvAddReal_PAC_vx: Acquire additional energy data of the REAL type

The table below shows the possible measured values for the "REAL" data record in the "addDataReal.actValue" output structure:

Number	Measured value type	Data type	Unit
22*	THD-R voltage L1 (-L2)	REAL	%
23*	THD-R voltage L2 (-L3)	REAL	%
24*	THD-R voltage L3 (-L1)	REAL	%
25*	THD-R current L1	REAL	%
26*	THD-R current L2	REAL	%
27*	THD-R current L3	REAL	%
29	Mean voltage UPh-N	REAL	V
30	Mean voltage UPh-Ph	REAL	V
31	Mean current Ph-Ph	REAL	A
36	Phase angle L1	REAL	°
37	Phase angle L2	REAL	°
38	Phase angle L3	REAL	°
53	Amplitude unbalance for voltage	REAL	%
54	Amplitude unbalance for current	REAL	%
76*	Max. THD-R voltage L1 (-L2)	REAL	%
77*	Max. THD-R voltage L2 (-L3)	REAL	%
78*	Max. THD-R voltage L3 (-L1)	REAL	%
79*	Max. THD-R current L1	REAL	%
80*	Max. THD-R current L2	REAL	%
81*	Max. THD-R current L3	REAL	%
83	Max. mean voltage UPh-N	REAL	V
84	Max. mean voltage UPh-Ph	REAL	V
85	Max. mean current	REAL	A
118	Min. mean voltage UPh-N	REAL	V
119	Min. mean voltage UPh-Ph	REAL	V
120	Min. mean current	REAL	A
127*	THD-R voltage L1-L2	REAL	%
128*	THD-R voltage L2-L3	REAL	%
129*	THD-R voltage L3-L1	REAL	%
130*	Max. THD-R voltage L1-L2	REAL	%
131*	Max. THD-R voltage L2-L3	REAL	%
132*	Max. THD-R voltage L3-L1	REAL	%

* Available only for "SENTRON PAC4200".

4.6.3 Status parameter

The table below shows the error codes which are output when errors occur at the "status" output parameter of the "EnSL_DrvAddReal_PAC_vx" block:

Error code (W#16#...)	Description	Solution
8013	Incorrect data type This block supports only the "REAL" data type.	Select a "REAL" parameter or read this parameter with the "EnSL_DrvAddLReal_PAC_vx" block.
8014	Incorrect offset value The limits (0 - 19) of the "energyMeta.typeAddValue" array from which the six "" values were read, have been exceeded.	Reduce the offset value.
8020	The measuring instrument returns an error. Current is above 1.2 times the measuring range (for example, when the starting current of a motor is high) or the voltage is outside the measuring range.	Check the setting of the measuring current or the measuring voltage in PAC3200/4200 or use the appropriate current transformer or voltage transformer. At the same time, note the current-carrying capacity.

4.7 EnSL_DrvAddLReal_PAC_vx: Acquire additional energy data of the type LREAL

4.7.1 Description of EnSL_DrvAddLReal_PAC_vx

The "EnSL_DrvAddLReal_PAC_vx" block makes available Additional measured values of the type REAL (64-bit) via acyclic communication. You can read up to three different "LREAL" values for each created instance of the block from PAC3200/4200.

4.7 EnSL_DrvAddLReal_PAC_vx: Acquire additional energy data of the type LREAL

The figure below shows the mode of operation of the "EnSL_DrvAddLReal_PAC_vx" block:

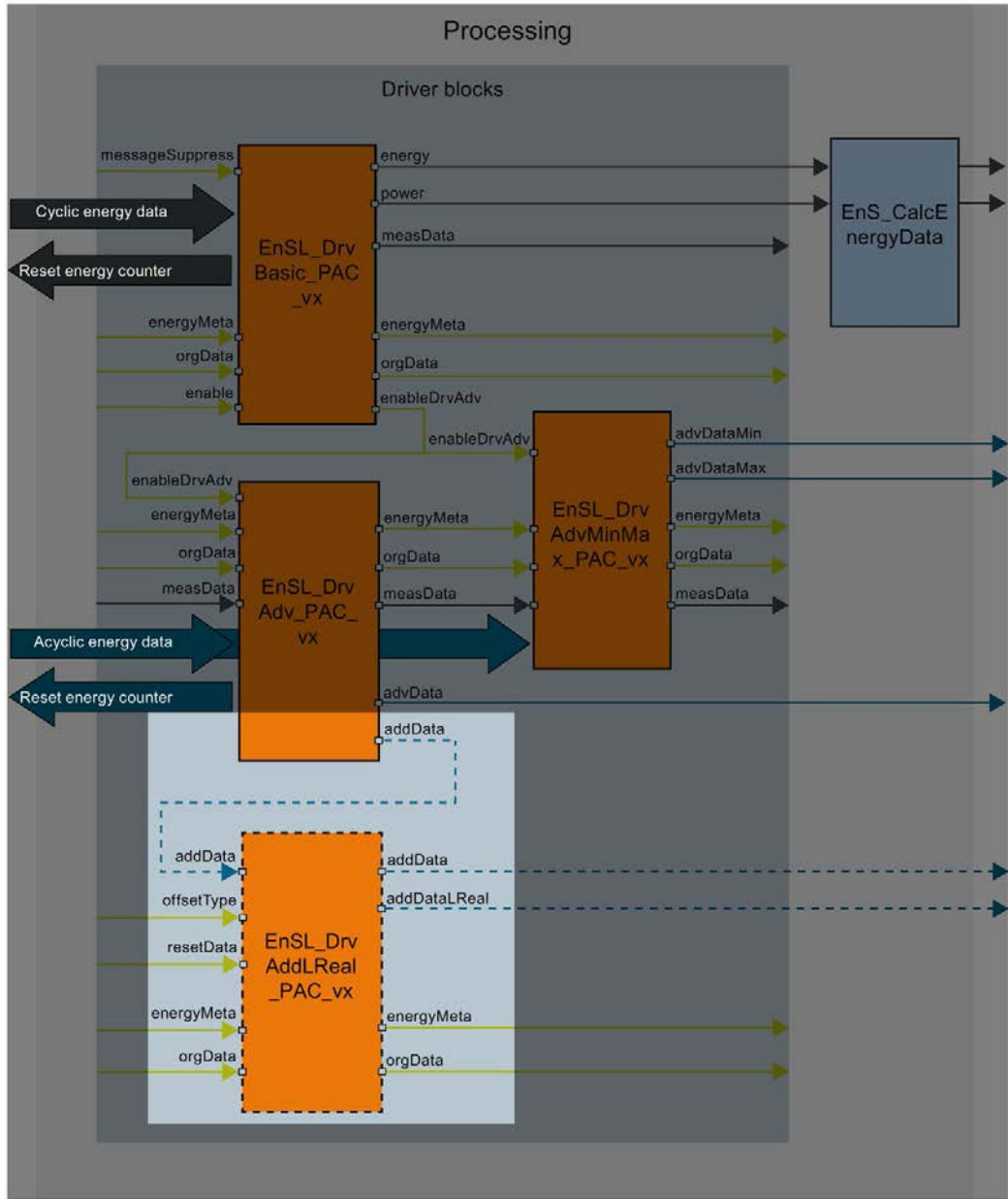

- Energy data via acyclic communication (read/write data record)
- SENTRON PAC blocks
- Parameter assignment data
- Required blocks
- Optional blocks

4.7.2 EnSL_DrvAddLReal_PAC_vx parameter

The table below shows the parameters of the "EnSL_DrvAddLReal_PAC_vx" block that are relevant for the Energy Suite:

Parameter	Declaration	Data type	Preassigned value	Description
offsetType	Input	UINT	0	Offset value in the array Specifies a numerical value (number) starting at which the three follow-on "LREAL" values are read from the "energyMeta.typeAddValue" array.
addDataLReal	Output	EnS_typeEnergyAddLReal	-	Momentary "LREAL" data record Contains three "LREAL" values, which are made available in the "addDataLReal.actValue" output structure
status	Output	WORD	-	Error status information (Page 67)
energyMeta	InOut	EnS_typeEnergyMeta	-	Measuring-point-specific data
addData	InOut	EnSL_typeAddSENTRON (Page 68)	-	Data transfer from the "EnSL_DrvAdv_PAC_vx" block Contains: <ul style="list-style-type: none"> • 20 "LREAL" values • 20 measured value addresses • 20 measured value lengths

Settings at the "offsetType" parameter

The value at the input parameter "offsetType" refers to the index of the array element "typeAddValue" of the user-defined data type "EnS_typeEnergyMeta". The default setting is "0". Enter a numerical value at the "offsetType" parameter (valid values: 0 - 19). The numerical value represents the position of a lower-level array element of "typeAddValue". Up to three follow-on values are read from the PAC3200/4200 starting at the specified numerical value.

You can find an example for using the parameter "offsetType" in the section "EnSL_DrvAddReal_PAC_vx parameter (Page 60)".

The table below shows the possible measured values for the "LREAL" data record in the "addDataLReal.actValue" output structure:

Number	Measured value type	Data type	Unit
49	Total reactive energy inflow (tariff 1)	LREAL	varh
50	Total reactive energy outflow (tariff 1)	LREAL	varh
51	Total active energy inflow (tariff 1)	LREAL	Wh
52	Total active energy outflow (tariff 1)	LREAL	Wh
125	Total apparent energy (tariff 1)	LREAL	VAh

4.7.3 Status parameter

The table below shows the error codes which are output when errors occur at the "status" output parameter of the "EnSL_DrvAddLReal_PAC_vx" block:

Error code (W#16#...)	Description	Solution
8013	Incorrect data type This block supports only the "LREAL" data type.	Select a "REAL" parameter or read this parameter with the "EnSL_DrvAddReal_PAC_vx" block.
8014	Incorrect offset value The limits (0 - 19) of the "energyMeta.typeAddValue" array, from which the three "LREAL" values were read, have been exceeded.	Reduce the offset value.
8020	The measuring instrument returns an error. Current is above 1.2 times the measuring range (for example, when the starting current of a motor is high) or the voltage is outside the measuring range.	Check the setting of the measuring current or the measuring voltage in PAC3200/4200 or use the appropriate current transformer or voltage transformer. At the same time, note the current-carrying capacity.

4.8 User-defined data types (UDTs) from SENTRON PAC3200/4200

4.8.1 EnSL_typeAdvPAC

4.8.1.1 Description of EnSL_typeAdvPAC

The PLC data type "EnSL_typeAdvPAC" contains advanced measured values which are transferred to the blocks "EnSL_DrvAdv_PAC_vx" and/or "EnSL_DrvAdvMinMax_PAC_vx".

4.8.1.2 Structure of EnSL_typeAdvPAC

The table below shows the parameters of the "EnSL_typeAdvPAC" PLC data type:

Parameter	Data type	Preassigned value	Description
totalActPower	REAL	0.0	Momentary total active power
actEnergyImpT1	LREAL	0.0	Active energy inflow tariff 1
actEnergyExpT1	LREAL	0.0	Active energy outflow tariff 1
status	WORD	16#0000	Error status information

4.8.2 EnSL_typeAddSENTRON

4.8.2.1 Description of EnSL_typeAddSENTRON

The PLC data type "EnSL_typeAddPAC" make available energy data for the blocks "EnSL_DrvAddReal_PAC_vx" and "EnSL_DrvAddLReal_PAC_vx".

4.8.2.2 Structure of EnSL_typeAddSENTRON

The table below shows the parameters of the PLC data type "EnSL_typeAddSENTRON":

Parameter	Data type	Preassigned value	Description
valueReal0	REAL	0.0	Measured value 0 at the "addData" parameter
...	REAL	0.0	...
valueReal19	REAL	0.0	Measured value 19 at the "addData" parameter
valueLReal0	LREAL	0.0	Measured value 0 at the "addData" parameter
...	LREAL	0.0	...
valueLReal19	LREAL	0.0	Measured value 19 at the "addData" parameter
valueAddress0	WORD	16#0000	Measured value address 0 at the "addData" parameter
...	WORD	16#0000	...
valueAddress19	WORD	16#0000	Measured value address 19 at the "addData" parameter
valueLegth0	INT	0	Measured value length 0 at the "addData" parameter
...	INT	0	...
valueLength19	INT	0	Measured value length 19 at the "addData" parameter
status	WORD	16#0000	Error status information

SENTRON 3VA

5.1 Description of SENTRON 3VA

The molded-case circuit breaker SENTRON 3VA with ETU of the 8th row, subsequently called "3VA", and a COM060 communication module, is an intelligent protection device MCCB (Molded Case Circuit Breaker) with measuring function for measuring relevant system parameters in the low-voltage power distribution. To do this, the 3VA makes available the measured energy data (e.g. power, energy, voltage current) at its PROFINET interface via the COM800 or COM100 data concentrator with Switched Ethernet PROFINET communication expansion module. The energy data can be read by the connected SIMATIC controller (for example, S7-1500) at the PROFINET interface. The following section describes the driver blocks that enable simplified and standardized communication.

Integration in TIA Portal hardware catalog

3VA can be connected via PROFINET IO in the TIA Portal. To configure the hardware, you need a generic station description file (PROFINET IO: GSDML file). The GSDML file is designed only for use of the corresponding communication expansion module with the relevant model of the COM800 and/or COM100 data concentrator.

You can find the corresponding general station description file in the Siemens Industry Online Support (<https://support.industry.siemens.com/cs/?lc=en-VWV>).

A specific hardware configuration has to be set in order to use 3VA as energy data source in Energy Suite. You can find the required hardware configuration in the section "Hardware Configuration and Parameter Assignment (Page 72)".

Application

The supplied driver blocks for 3VA are contained in the global library of the "Energy Support Library".

The table below shows the driver blocks of 3VA:





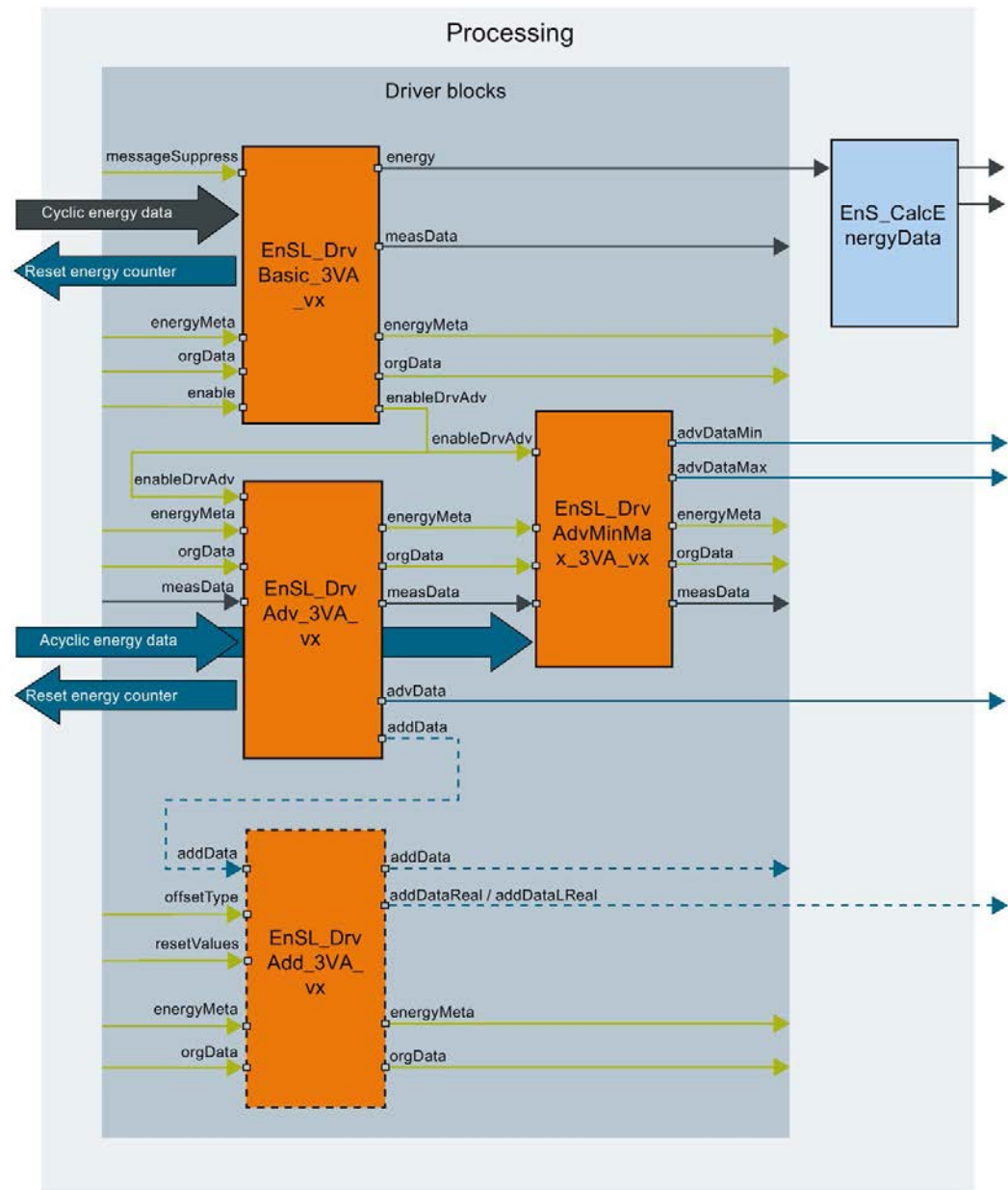

Name	Function
EnSL_DrvBasic_3VA_vx	Driver block for 3VA for basic energy data
EnSL_DrvAdv_3VA_vx	Driver block for 3VA for advanced energy data
EnSL_DrvAdvMinMax_3VA_vx	Driver block for 3VA for advanced minimum and maximum values
EnSL_DrvAddLReal_3VA_vx	Driver block for 3VA for additional energy data of the LREAL type
EnSL_DrvAddREAL_3VA_vx	Driver block for 3VA for additional energy data of the REAL type

5.2 Mode of operation of the driver blocks for SENTRON 3VA

The driver blocks read the energy data from 3VA via cyclic or acyclic communication. You can find the general overview of the energy data processing in the section "Energy data processing based on the "IPO" principle (Page 14)".

The figure below shows the structure and the data flow of the 3VA blocks:



-  Energy data via cyclic communication (process image)
-  Energy data via acyclic communication (read/write data record)
-  Parameter assignment data
-  SENTRON 3VA blocks
-  Energy Suite blocks
-  Required blocks
-  Optional blocks

5.3 EnSL_DrvBasic_3VA_vx: Acquire basic energy data

5.3.1 Description of EnSL_DrvBasic_3VA_vx

The "EnSL_DrvBasic_3VA_vx" block reads the basic energy data (momentary active energy) from 3VA and transfer this to the "EnS_CalcEnergyData" and "EnSL_DrvAdv_3VA_vx" blocks.

The minimum and maximum values can be reset with the block using a positive edge at the corresponding input parameter.

The switching commands "On", "Off" and "Acknowledge trip" can also be issued via the block if a motorized operating mechanism with spring energy store (SEO) is installed.

The figure below shows the mode of operation of the "EnSL_DrvBasic_3VA_vx" block:

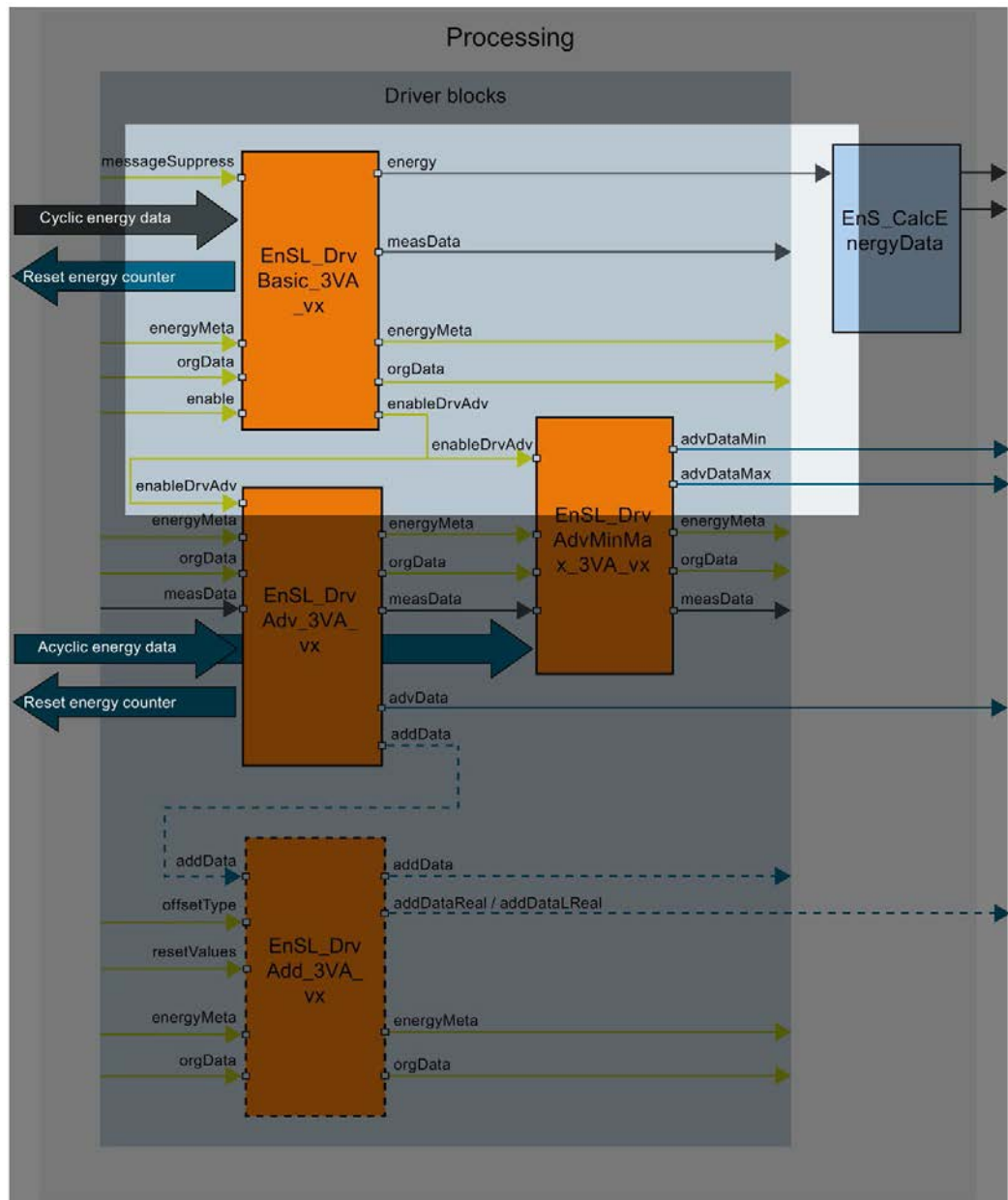

- Energy data via cyclic communication (process image)
- Energy data via acyclic communication (read/write data record)
- Parameter assignment data
- SENTRON 3VA blocks
- Energy Suite blocks

Hardware configuration and parameter assignment

The measurement data are read cyclically by the PLC from the 3VA. The "EnSL_DrvBasic_3VA_vx" block requires the HW ID of the following submodule for this purpose:

- COM100 / COM800 ①
- Switch_X ②
- Control / status bytes ③
- Basic type 5 ④

During the generation of the energy program, the hardware IDs are read and saved in "EnS_EnergyDataBasic.energyMeta".

The figure below shows the configuration of the 3VA in the device view:

Module	Rack	Slot	I address	Q address
① COM800	0	0		
▶ PN-IO	0	0 X1		
② Breaker_1	0	1		
COM 060	0	1 1		
③ Breaker Control/Status	0	1 2	64...65	64...65
④ Basic Type 5	0	1 3	66...89	

5.3.2 EnSL_DrvBasic_3VA_vx parameter

The table below shows the parameters of the "EnSL_DrvBasic_3VA_vx" block that are relevant for the Energy Suite:

Parameter	Declaration	Data type	Preassigned value	Description
enable	Input	BOOL	FALSE	TRUE = Processing enable
messageSuppress	Input	BOOL	FALSE	TRUE = Alarm suppression
energy	Input	EnS_typeEnergyCounter	-	Momentary value of the active energy counter
measData	Output	EnSL_typeAdv3VA (Page 90)	-	Cyclic measured values that are read from the 3VA and transferred to the "EnSL_DrvAdv_3VA_vx" block as advanced energy data.
status	Output	WORD	-	Error status information (Page 75)
orgData	InOut	EnS_typeOrgData	-	Organization data
energyMeta	InOut	EnS_typeEnergyMeta	-	Measuring-point-specific data Extract of relevant parameters: <ul style="list-style-type: none"> • energyMeta.mode • energyMeta.normFactorIn • energyMeta.inputType • energyMeta.connectionType • energyMeta.overflowCntValue

5.3.3 Status parameter

The table below shows the error codes which are output when errors occur at the "status" output parameter of the "EnSL_DrvBasic_3VA_vx" block:

Error code (W#16#...)	Description	Solution
8001	Connection with 3VA is interrupted / extended instruction "GETIO" has failed	Establish a connection to the measuring instrument. You can find additional information on error correction in the extended instruction "GETIO".
8004	Extended instruction "WRREC" timeout.	You can find additional information on error correction in the description of the extended instruction "WRREC". The error code of the instruction is contained in the "statusWRREC" parameter.
8005	Writing data to 3VA has failed.	
8008	"GETIO" extended instruction has failed	You can find additional information on error correction in the extended instruction "GETIO". The error code of the instruction is contained in the "statusGETIO" parameter.
8011	Energy flow direction invalid	Enter a valid value at the parameter for energy flow direction
8020	The measuring instrument returns an error. The switch has tripped or load shedding is active.	Check and correct the reason 3VA was tripped.

5.3.4 Alarms

If the connection to the 3VA is interrupted (status 16#8xxx), an alarm is output via the advanced instruction "Program_Alarm".

The table below shows the alarms of the "EnSL_DrvBasic_3VA_vx" block:

Alarm block	Alarm text	Alarm class
Program_Alarm	Connection lost	With acknowledgment

The alarm can be changed and configured in WinCC.

When the driver block is used in the Energy Suite, the alarm via the "EnS_Organization" function block can be centrally suppressed.

5.4 EnSL_DrvAdv_3VA_vx: Acquire advanced energy data

5.4.1 Description of EnSL_DrvAdv_3VA_vx

The "EnSL_DrvAdv_3VA_vx" block uses the acyclic data transfer of the Advanced Energy data from 3VA. The advanced energy data (for example, current, voltage, frequency) are transferred to the output structure at the "EnS_EnergyDataAdv" function block.

The figure below shows the mode of operation of the "EnSL_DrvAdv_3VA_vx" block:

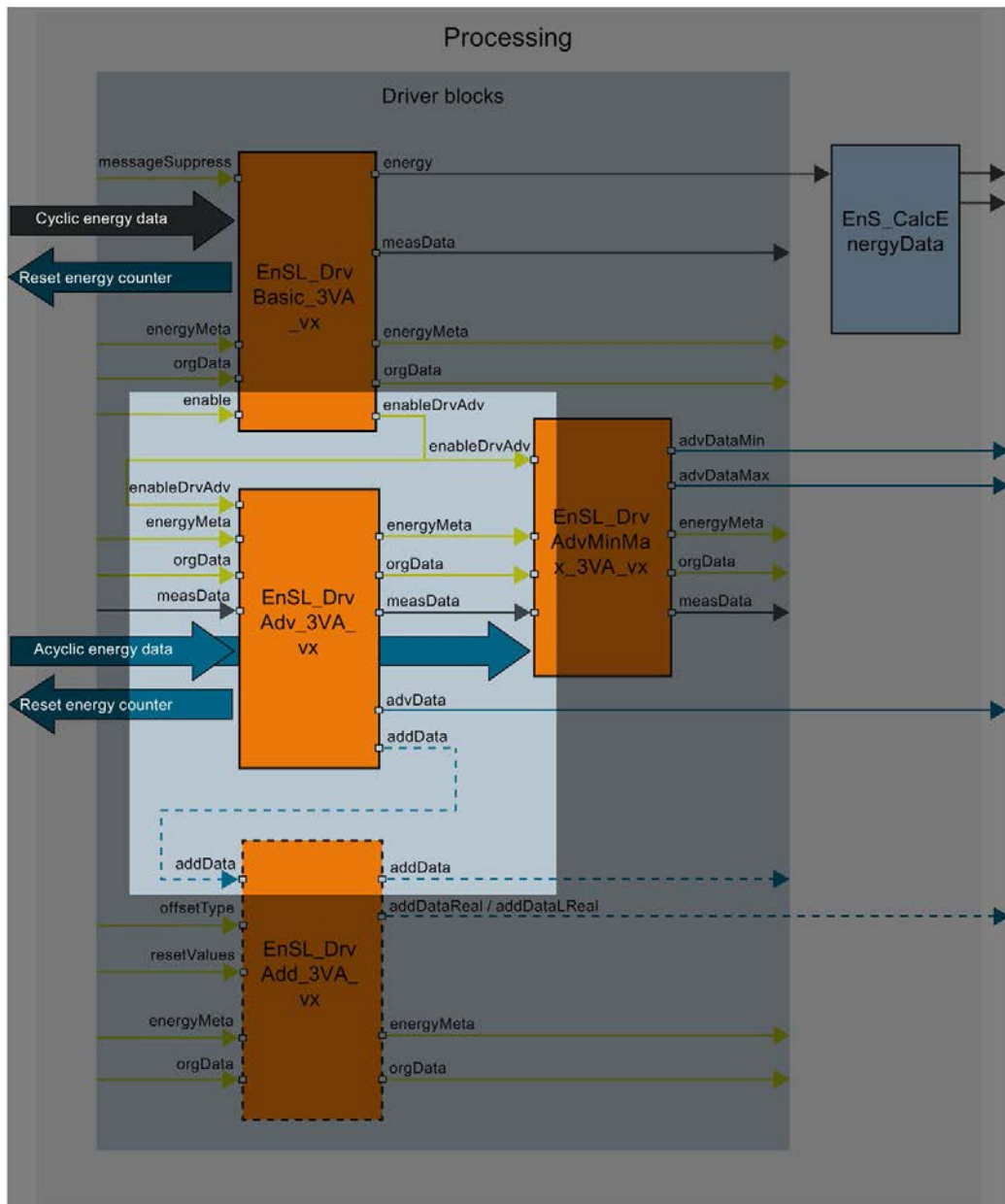

- Energy data via cyclic communication (process image)
- Energy data via acyclic communication (read/write data record)
- SENTRON 3VA blocks
- Energy Suite blocks
- Parameter assignment data
- Required blocks
- Optional blocks

5.4.2 EnSL_DrvAdv_3VA_vx parameter

The table below shows the parameters of the "EnSL_DrvAdv_3VA_vx" block that are relevant for the Energy Suite:

Parameter	Declaration	Data type	Preassigned value	Description
enableDrvAdv	Input	BOOL	FALSE	TRUE = Processing enable
addData	Output	EnSL_typeAddSENTRON (Page 91)	-	Data transfer for additional "EnSL_DrvAddReal_3VA_vx" and "EnSL_DrvAddLReal_3VA_vx" blocks. Contains: <ul style="list-style-type: none"> • 20 "LREAL" values • 20 "LREAL" values • 20 measured value addresses • 20 measured value lengths
advData	Output	EnS_typeEnergyAdv	-	Advanced measurement data record Transferred to the "EnS_EnergyDataAdv" function block.
status	Output	WORD	-	Error status information (Page 77)
energyMeta	InOut	EnS_typeEnergyMeta	-	Measuring-point-specific data

5.4.3 Status parameter

The following table shows the error codes that are generated at the "status" output parameter of the "EnSL_DrvAdv_3VA_vx" function block when errors occur:

Error code (W#16#...)	Description	Solution
8002	"RDREC" advanced instruction timeout	Additional information on error correction is available in the description of the advanced instruction "RDREC". The error code of the instruction is contained in the "statusRDREC" parameter.
8003	Reading data from 3VA has failed.	
8004	"WRREC" advanced instruction timeout	Additional information on error correction is available in the description of the advanced instruction "WRREC". The error code of the instruction is contained in the "statusWRREC" parameter.
8005	Writing data to 3VA has failed.	
8020	The measuring instrument returns an error. The switch has tripped or load shedding is active.	Check and correct the reason 3VA was tripped.

5.5 EnSL_DrvAdvMinMax_3VA_vx: Acquire advanced minimum and maximum values

5.5.1 Description of EnSL_DrvAdvMinMax_3VA_vx

The "EnSL_DrvAdvMinMax_3VA_vx" block uses the acyclic data transfer of the Advanced Energy data from 3VA. The advanced minimum and maximum values (e.g. minimum current, minimum voltage, minimum frequency) are transferred to the output structures at the "EnS_EnergyDataAdvMinMax" function block.

5.5 EnSL_DrvAdvMinMax_3VA_vx: Acquire advanced minimum and maximum values

The figure below shows the mode of operation of the "EnSL_DrvAdvMinMax_3VA_vx" block:

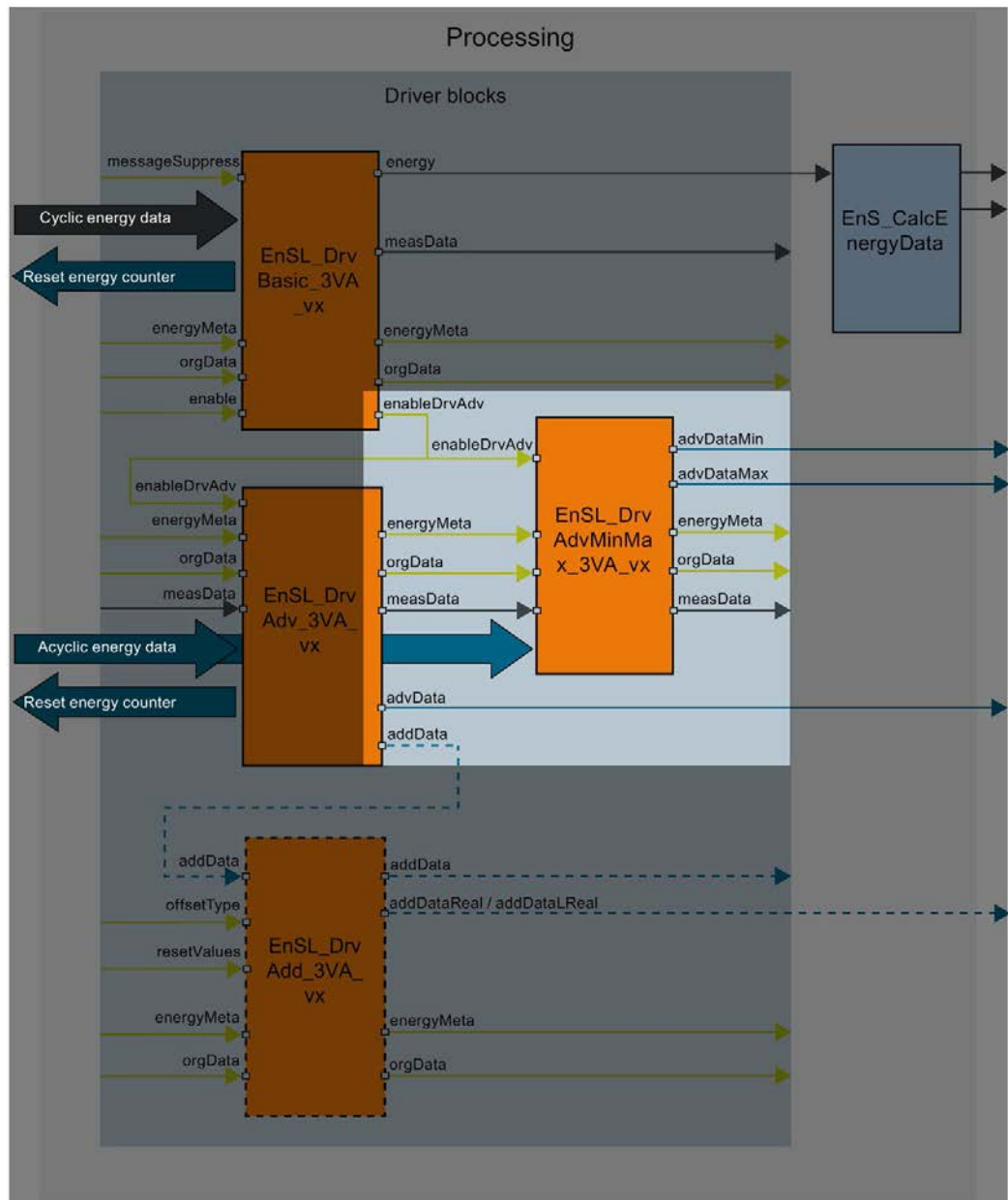

- Energy data via cyclic communication (process image)
- Energy data via acyclic communication (read/write data record)
- Parameter assignment data
- SENTRON 3VA blocks
- Energy Suite blocks

5.5.2 EnSL_DrvAdvMinMax_3VA_vx parameter

The table below shows the parameters of the "EnSL_DrvAdvMinMax_3VA_vx" block that are relevant for the Energy Suite:

Parameter	Declaration	Data type	Preassigned value	Description
enableDrvAdv	Input	BOOL	FALSE	TRUE = Processing enable
advDataMin	Output	EnS_typeEnergyAdv	-	Advanced measurement data record with minimum values Transferred to the "EnS_EnergyDataAdvMinMax" function block.
advDataMax	Output	EnS_typeEnergyAdv	-	Advanced measurement data record with maximum values Transferred to the "EnS_EnergyDataAdvMinMax" function block.
status	Output	WORD	-	Error status information (Page 80)
measData	InOut	EnSL_typeAdv3VA (Page 90)	-	Cyclic measured values that are read from the 3VA and transferred to the "EnSL_DrvAdvMinMax_3VA_vx" block as advanced energy data .
orgData	InOut	EnS_typeOrgData	-	Organization data
energyMeta	InOut	EnS_typeEnergyMeta	-	Measuring-point-specific data

5.5.3 Status parameter

The table below shows the error codes which are output when errors occur at the "status" output parameter of the "EnSL_DrvAdvMinMax_3VA_vx" block:

Error code (W#16#...)	Description	Solution
8002	"RDREC" advanced instruction timeout	Additional information on error correction is available in the description of the advanced instruction "RDREC". The error code of the instruction is contained in the "statusRDREC" parameter.
8003	Reading data from 3VA has failed.	
8004	"WRREC" advanced instruction timeout	Additional information on error correction is available in the description of the advanced instruction "WRREC". The error code of the instruction is contained in the "statusWRREC" parameter.
8005	Writing data to 3VA has failed.	
8020	The measuring instrument returns an error. The switch has tripped or load shedding is active.	Check and correct the reason 3VA was tripped.

5.6 EnSL_DrvAddLReal_3VA_vx: Acquire additional energy data of REAL type

5.6.1 Description of EnSL_DrvAddLReal_3VA_vx

The "EnSL_DrvAddLReal_3VA_vx" block makes available Additional measured values of the type "LREAL" (64-bit) via acyclic communication. From 3VA, you can read up to three different "LREAL" values for each created instance of the block.

5.6 EnSL_DrvAddLReal_3VA_vx: Acquire additional energy data of REAL type

The figure below shows the mode of operation of the "EnSL_DrvAddLReal_3VA_vx" block:

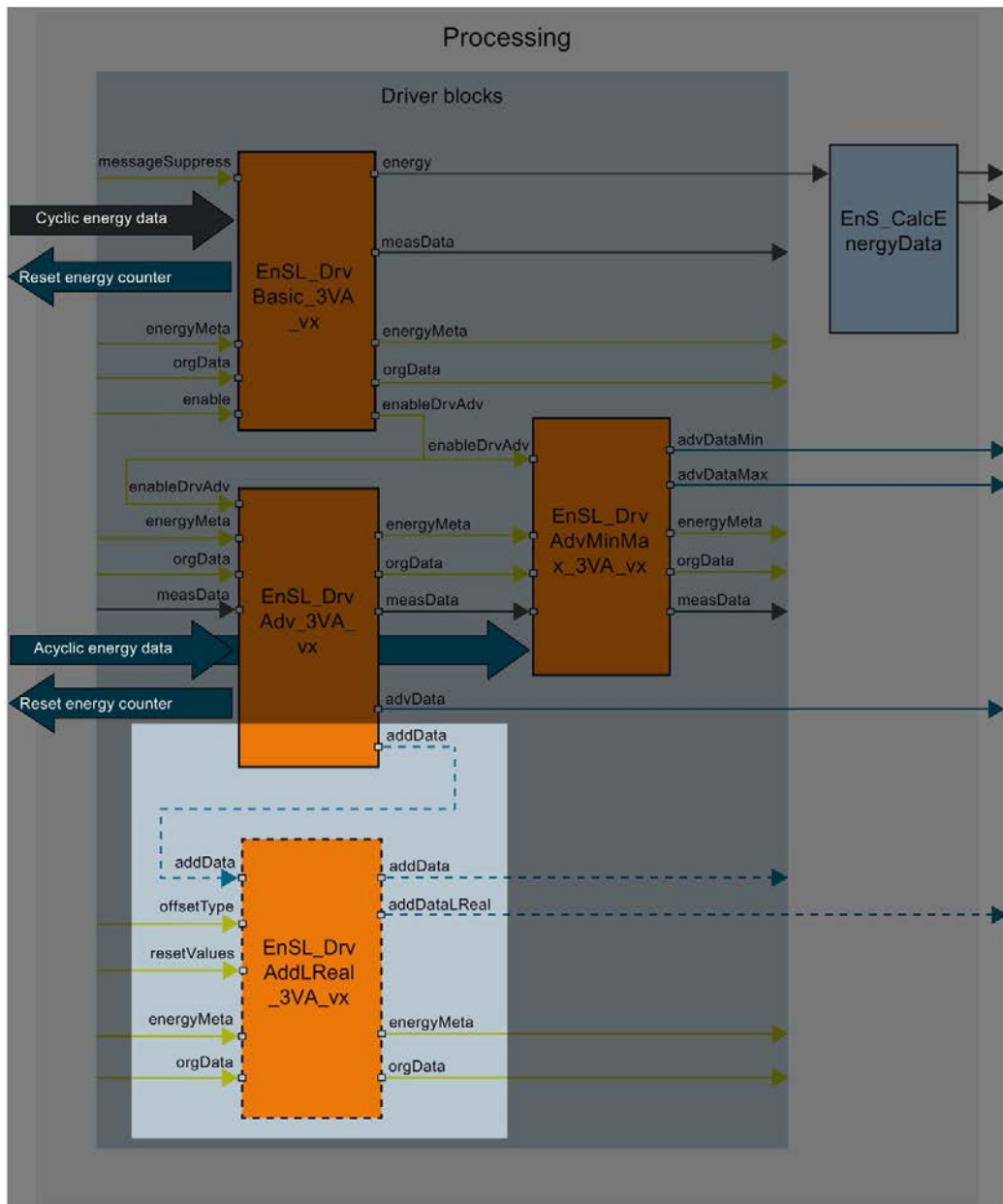

- Energy data via acyclic communication (read/write data record)
- Parameter assignment data
- SENTRON 3VA blocks
- Required blocks
- Optional blocks

5.6.2 EnSL_DrvAddLReal_3VA_vx parameter

The table below shows the parameters of the "EnSL_DrvAddLReal_3VA_vx" block that are relevant for the Energy Suite:

Parameter	Declaration	Data type	Preassigned value	Description
offsetType	Input	UINT	0	Offset value in the "energyMeta.typeAddValue" array Specifies a numerical value (number) starting at which the three follow-on "LREAL" values are read from the "energyMeta.typeAddValue" array.
addDataLReal	Output	EnS_typeEnergyAddLReal	-	Momentary "LREAL" data record Contains three "LREAL" values, which are made available in the "addDataLReal.actValue" output structure
energyMeta	InOut	EnS_typeEnergyMeta	-	Measuring-point-specific data
status	Output	WORD	-	Error status information (Page 84)
addData	InOut	EnSL_typeAddSENTRON (Page 90)	-	Data transfer from the "EnSL_DrvAdv_3VA_vx" block Contains: <ul style="list-style-type: none"> • 20 "LREAL" values • 20 measured value addresses • 20 measured value lengths

Settings at the "offsetType" parameter

The value at the input parameter "offsetType" refers to the index of the array element "typeAddValue" of the user-defined data type "EnS_typeEnergyMeta". The default setting is "0". Enter a numerical value at the "offsetType" parameter (valid values: 0 - 19). The numerical value represents the position of a lower-level array element of "typeAddValue". Up to three follow-on values are read from the 3VA starting at the specified numerical value.

You can find an example for using the parameter "offsetType" in the section "EnSL_DrvAddReal_3VA_vx parameter (Page 86)".

The table below shows the possible measured values in the "addDataLReal.actValue" output structure:

Number	Measured value type	Data type	Unit
49	Total reactive energy inflow	LREAL	varh
50	Total reactive energy outflow	LREAL	varh
51	Total active energy inflow	LREAL	Wh
52	Total active energy outflow	LREAL	Wh
125	Total apparent energy	LREAL	VAh

5.6.3 Status parameter

The table below shows the error codes which are output when errors occur at the "status" output parameter of the "EnSL_DrvAddLReal_3VA_vx" block:

Error code (W#16#...)	Description	Solution
8013	Incorrect data type This block supports only the "LREAL" data type.	Select a "REAL" parameter or read this parameter with the "EnSL_DrvAddReal_3VA_vx" block.
8014	Incorrect offset value The limits (0 - 19) of the "energyMeta.typeAddValue" array, from which the three "LREAL" values were read, have been exceeded.	Reduce the offset value.
8020	The measuring instrument returns an error. The switch has tripped or load shedding is active.	Check and correct the reason 3VA was tripped.

5.7 EnSL_DrvAddReal_3VA_vx: Acquire additional energy data of REAL type

5.7.1 Description of EnSL_DrvAddReal_3VA_vx

The "EnSL_DrvAddReal_3VA_vx" block makes available Additional measured values of the type "REAL" (32-bit) via acyclic communication. You can read up to six different REAL values for each created instance of the block from the 3VA.

5.7 EnSL_DrvAddReal_3VA_vx: Acquire additional energy data of REAL type

The figure below shows the mode of operation of the "EnSL_DrvAddReal_3VA_vx" block:

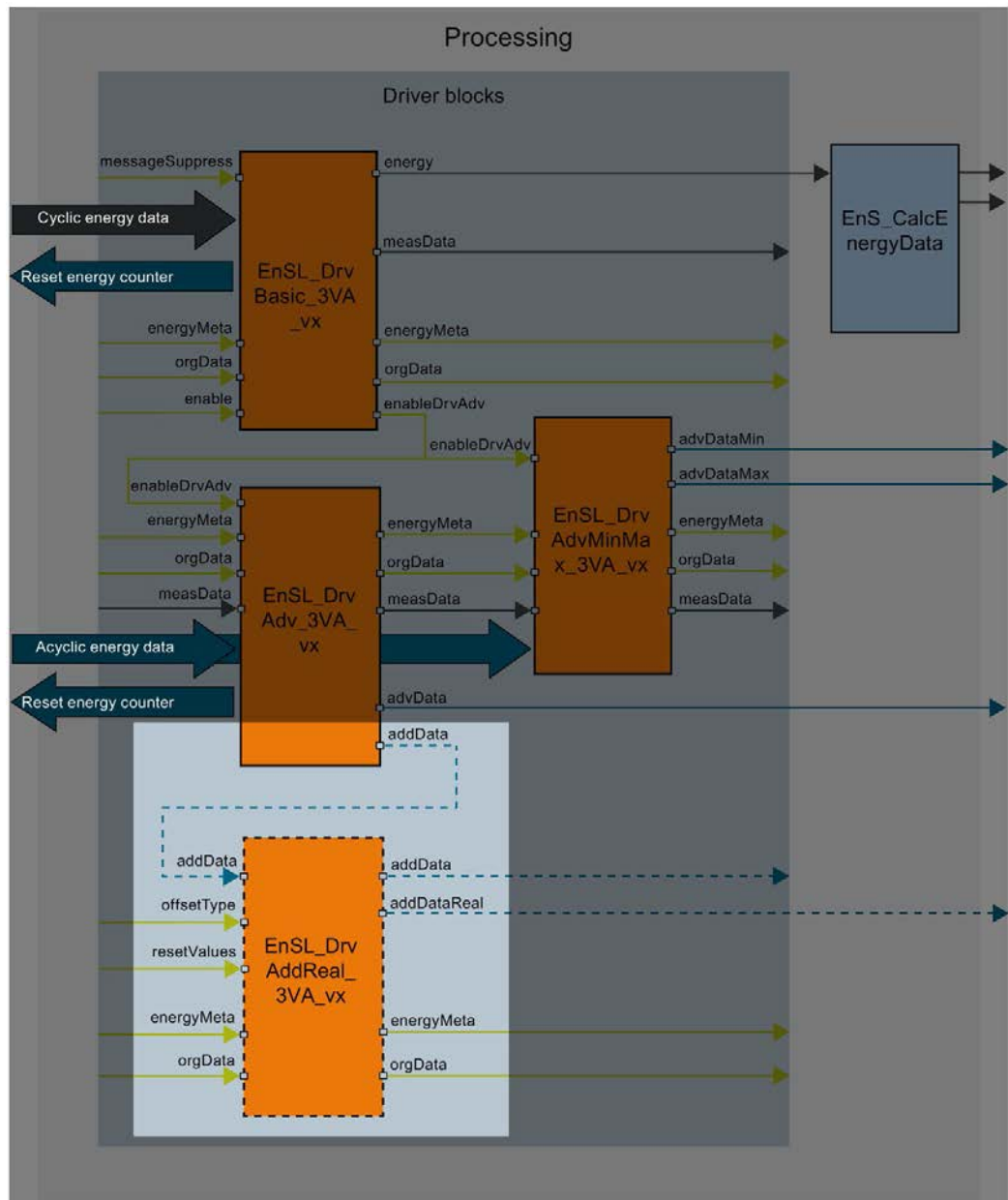

5.7.2 EnSL_DrvAddReal_3VA_vx parameter

The table below shows the parameters of the "EnSL_DrvAddReal_3VA_vx" block that are relevant for the Energy Suite:

Parameter	Declaration	Data type	Preassigned value	Description
offsetType	Input	UINT	0	Offset value in the "energyMeta.typeAddValue" array Specifies the numerical value (number) starting at which the six follow-on "REAL" values are read from the "energyMeta.typeAddValue" array.
addDataReal	Output	EnS_typeEnergyAddReal	-	Momentary "REAL" data record Contains up to six "REAL" values which are made available in the "addDataReal.actValue" output structure.
status	Output	WORD	-	Error status information (Page 90)
addData	InOut	EnSL_typeAddSENTRON (Page 90)	-	Data transfer from the "EnSL_DrvAdv_3VA_vx" block Contains: <ul style="list-style-type: none"> • 20 "LREAL" values • 20 measured value addresses • 20 measured value lengths
energyMeta	InOut	EnS_typeEnergyMeta	-	Measuring-point-specific data

Settings at the "offsetType" parameter

The value at the input parameter "offsetType" refers to the index of the array element "typeAddValue" of the user-defined data type "EnS_typeEnergyMeta". The default setting is "0". Enter a numerical value at the "offsetType" parameter (valid values: 0 - 19). The numerical value represents the position of a lower-level array element of "typeAddValue". Up to six follow-on values starting at the specified numerical value are read from 3VA.

Example of the "offsetType" parameter

The figure below shows the block call of "EnSL_DrvAddReal_3VA_vx":

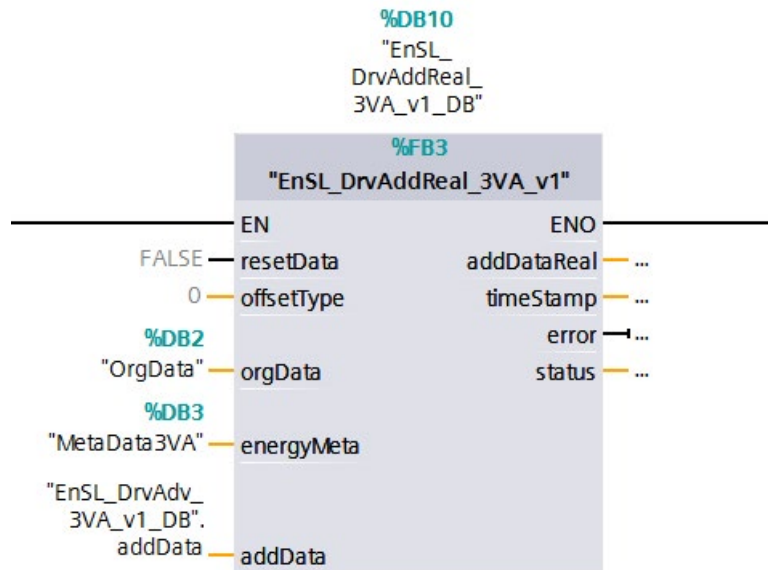

The value "0" is set at the "offsetType" parameter.

The figure below shows the entire "energyMeta.typeAddValue" array from the user-defined "EnS_typeEnergyMeta" data type:

Name	Data type	Start value
typeAddValue	Array[0..19] of UInt	
typeAddValue[0]	UInt	22
typeAddValue[1]	UInt	29
typeAddValue[2]	UInt	30
typeAddValue[3]	UInt	31
typeAddValue[4]	UInt	53
typeAddValue[5]	UInt	54
typeAddValue[6]	UInt	49
typeAddValue[7]	UInt	50
typeAddValue[8]	UInt	51
typeAddValue[9]	UInt	0
typeAddValue[10]	UInt	0
typeAddValue[11]	UInt	0
typeAddValue[12]	UInt	0
typeAddValue[13]	UInt	0
typeAddValue[14]	UInt	0
typeAddValue[15]	UInt	0
typeAddValue[16]	UInt	0
typeAddValue[17]	UInt	0
typeAddValue[18]	UInt	0
typeAddValue[19]	UInt	0

5.7 EnSL_DrvAddReal_3VA_vx: Acquire additional energy data of REAL type

The "energyMeta.typeAddValue" array contains 20 elements of the type "UINT". Each of the elements has a start value which refers to the number of the measured value type. The measured value types can be arranged in any gap-less sequence in the "energyMeta.typeAddValue" array.

Because the "offsetType" parameter has the value "0", the following six measured values are written in the "REAL" data record:

- energyMeta.typeAddValue[0] = Start value 22: THD-R voltage L1 (-L2)
- energyMeta.typeAddValue[1] = Start value 29: Mean voltage UPh-N
- energyMeta.typeAddValue[2]= Start value 30: Mean voltage UPh-Ph
- energyMeta.typeAddValue[3]= Start value 31: Mean current Ph-Ph
- energyMeta.typeAddValue[4] = Start value 53: Amplitude unbalance for voltage
- energyMeta.typeAddValue[5] = Start value 54: Amplitude unbalance for current

The six values are output at the "addDataReal" output of the "EnSL_DrvAddReal_PAC_vx" block and written in the corresponding instance data block.

The figure below shows the offline view of the "addDataReal" output with the six "REAL" values:

Name	Data type	Start value
addDataReal	"EnS_typeEnergyAddReal"	
actValue	Array[0..5] of "EnS_typeAddValueReal"	
actValue[0]	"EnS_typeAddValueReal"	
value	Real	0.0
type	UInt	0
actValue[1]	"EnS_typeAddValueReal"	
value	Real	0.0
type	UInt	0
actValue[2]	"EnS_typeAddValueReal"	
actValue[3]	"EnS_typeAddValueReal"	
actValue[4]	"EnS_typeAddValueReal"	
actValue[5]	"EnS_typeAddValueReal"	

5.7 EnSL_DrvAddReal_3VA_vx: Acquire additional energy data of REAL type

The table below shows the possible measured values for the "REAL" data record in the "addDataReal.actValue" output structure:

Number	Measured value type	Data type	Unit
22	THD-R voltage L1 (-L2)	REAL	%
23	THD-R voltage L2 (-L3)	REAL	%
24	THD-R voltage L3 (-L1)	REAL	%
25	THD-R current L1	REAL	%
26	THD-R current L2	REAL	%
27	THD-R current L3	REAL	%
29	Mean voltage UPh-N	REAL	V
30	Mean voltage UPh-Ph	REAL	V
31	Mean current Ph-Ph	REAL	A
53	Amplitude unbalance for voltage	REAL	%
54	Amplitude unbalance for current	REAL	%
76	Max. THD-R voltage L1 (-L2)	REAL	%
77	Max. THD-R voltage L2 (-L3)	REAL	%
78	Max. THD-R voltage L3 (-L1)	REAL	%
79	Max. THD-R current L1	REAL	%
80	Max. THD-R current L2	REAL	%
81	Max. THD-R current L3	REAL	%
83	Max. mean voltage UPh-N	REAL	V
84	Max. mean voltage UPh-Ph	REAL	V
85	Max. mean current	REAL	A
118	Min. mean voltage UPh-N	REAL	V
119	Min. mean voltage UPh-Ph	REAL	V
120	Min. mean current	REAL	A
127	THD-R voltage L1-L2	REAL	%
128	THD-R voltage L2-L3	REAL	%
129	THD-R voltage L3-L1	REAL	%
130	Max. THD-R voltage L1-L2	REAL	%
131	Max. THD-R voltage L2-L3	REAL	%
132	Max. THD-R voltage L3-L1	REAL	%
133	Phase with the highest current	REAL	A
134	Neutral conductor current	REAL	A
135	Ground-fault current	REAL	A
136	Maximum phase current	REAL	A
137	Maximum neutral conductor current	REAL	A
138	Minimum neutral conductor current	REAL	A

5.7.3 Status parameter

The table below shows the error codes which are output when errors occur at the "status" output parameter of the "EnSL_DrvAddReal_3VA_vx" block:

Error code (W#16#...)	Description	Solution
8013	Incorrect data type This block supports only the "REAL" data type.	Select a "REAL" parameter or read this parameter with the "EnSL_DrvAddLReal_3VA_vx" block.
8014	Incorrect offset value The limits (0 - 19) of the "energyMeta.typeAddValue" array from which the six "" values were read, have been exceeded.	Reduce the offset value.
8020	The measuring instrument returns an error. The switch has tripped or load shedding is active.	Check and correct the reason 3VA was tripped.

5.8 User-defined data types (UDTs) from 3VA

5.8.1 EnSL_typeAdv3VA

5.8.1.1 Description of EnSL_typeAdv3VA

The PLC data type "EnSL_typeAdv3VA" contains measured values which are transferred to the blocks "EnSL_DrvAdv_3VA_vx" and/or "EnSL_DrvAdvMinMax_3VA_vx".

5.8.1.2 Structure of EnSL_typeAdv3VA

The table below shows the parameters of the PLC data type "EnSL_typeAdv3VA":

Parameter	Data type	Preassigned value	Description
current1	REAL	0	Current L1
current2	REAL	0	Current L2
current3	REAL	0	Current L3
conductorHighestCurrent	REAL	0	Phase with the highest current
neutralCurrent	REAL	0	Neutral conductor current
actEnergyImp	REAL	0	Active energy inflow
status	WORD	-	Error status information

5.8.2 EnSL_typeAddSENTRON

5.8.2.1 Description of EnSL_typeAddSENTRON

The PLC data type "EnSL_typeAddSENTRON" makes available energy data for the blocks "EnSL_DrvAddReal_3VA_vx" and "EnSL_DrvAddLReal_3VA_vx".

5.8.2.2 Structure of EnSL_typeAddSENTRON

The table below shows the parameters of the PLC data type "EnSL_typeAdd3VA":

Parameter	Data type	Preassigned value	Description
valueReal0	REAL	0.0	Measured value 0 at the "addData" parameter
...	REAL	0.0	...
valueReal19	REAL	0.0	Measured value 19 at the "addData" parameter
valueLReal0	LREAL	0.0	Measured value 0 at the "addData" parameter
...	LREAL	0.0	...
valueLReal19	LREAL	0.0	Measured value 19 at the "addData" parameter
valueAddress0	WORD	16#0000	Measured value address 0 at the "addData" parameter
...	WORD	16#0000	...
valueAddress19	WORD	16#0000	Measured value address 19 at the "addData" parameter
valueLegth0	INT	0	Measured value length 0 at the "addData" parameter
...	INT	0	...
valueLength19	INT	0	Measured value length 19 at the "addData" parameter
status	WORD	16#0000	Error status information

SINAMICS AC/AC

6.1 Description of SINAMICS

With SINAMICS, Siemens offers you a platform ideally suited for the demanding requirements of the low voltage, direct voltage and medium-voltage area. The complete, integrated drive series covers all performance levels and is characterized by a high degree of flexibility, functionality and efficiency. The extensive portfolio impresses with integrated engineering, easy connection to the automation system and comprehensive safety functions. SINAMICS offer the correct connector for each application, power and performance.

Integration in TIA Portal hardware catalog

In the Energy Suite environment, SINAMICS is configured using the device master data file (PROFINET IO: GSDML file) in the hardware configuration. You can find the corresponding device master data file at Siemens Industry Online Support (<https://support.industry.siemens.com/cs/?lc=en-WW>).

A specific hardware configuration has to be set in order to use SINAMICS as energy data source in Energy Suite. You can find the required hardware configuration in the section "Hardware Configuration and Parameter Assignment (Page 93)".

Application

The AC/AC converters of the SINAMICS series, referred to as "SINAMICS" in the following, supported by the driver block "EnSL_DrvBasic_Sina_vx", are integrated in the Energy Suite environment via PROFINET IO in the TIA Portal.

Recommendation:

Commission the SINAMICS using the "Startdrive" tool. To do this, create the SINAMICS in a separate project and configure it. Then load the SINAMICS in the converter.

You can find more information on configuration in the documentation of the SINAMICS used.

The supplied driver blocks for SINAMICS are contained in the global library of the "Energy Support Library".

The table below show the driver block for SINAMICS:

Name	Function
EnSL_DrvBasic_Sina_vx	Driver block for SINAMICS AC/AC devices for basic energy data

6.2 Mode of operation of the driver blocks for AC/AC converters of the SINAMICS series

The driver block reads the energy data from the SINAMICS via cyclic and acyclic communication. You can find the general overview of the energy data processing in the section "Energy data processing based on the "IPO" principle (Page 14)".

The figure below shows the structure and the data flow of the SINAMICS block:

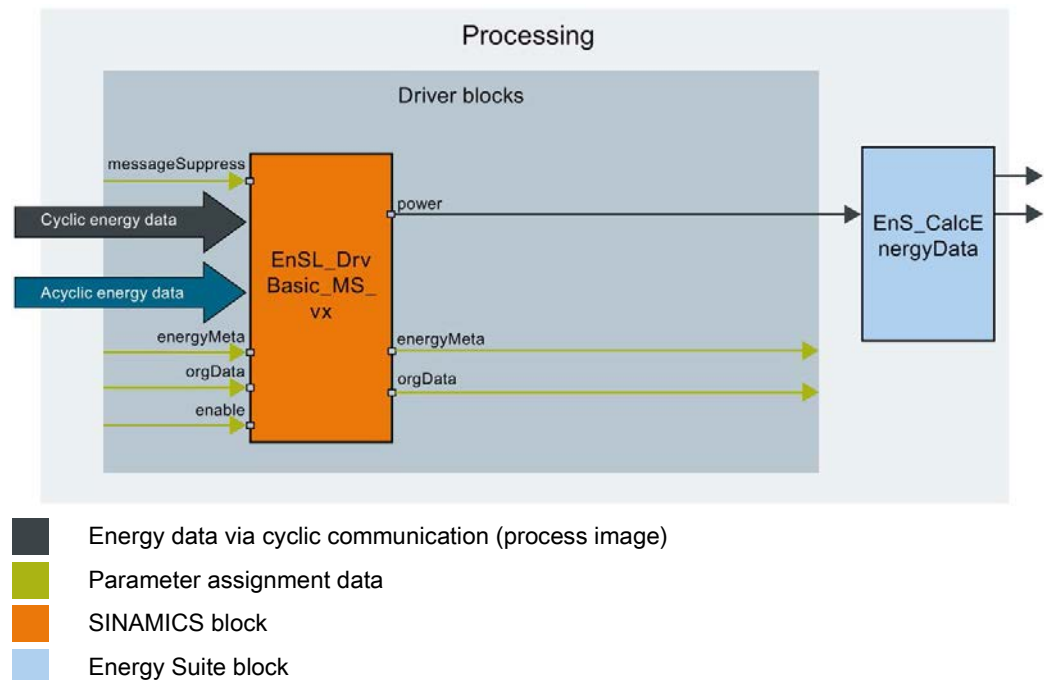

6.3 EnSL_DrvBasic_Sina_vx: Acquire basic energy data

6.3.1 Description of EnSL_DrvBasic_Sina_vx

The "EnSL_DrvBasic_Sina_vx" driver block reads the basic energy data from the SINAMICS and transfers the basic energy values to the "EnS_CalcEnergyData" block. These basic energy data are: Momentary active power.

The figure below shows the mode of operation of the "EnSL_DrvBasic_Sina_vx" block:

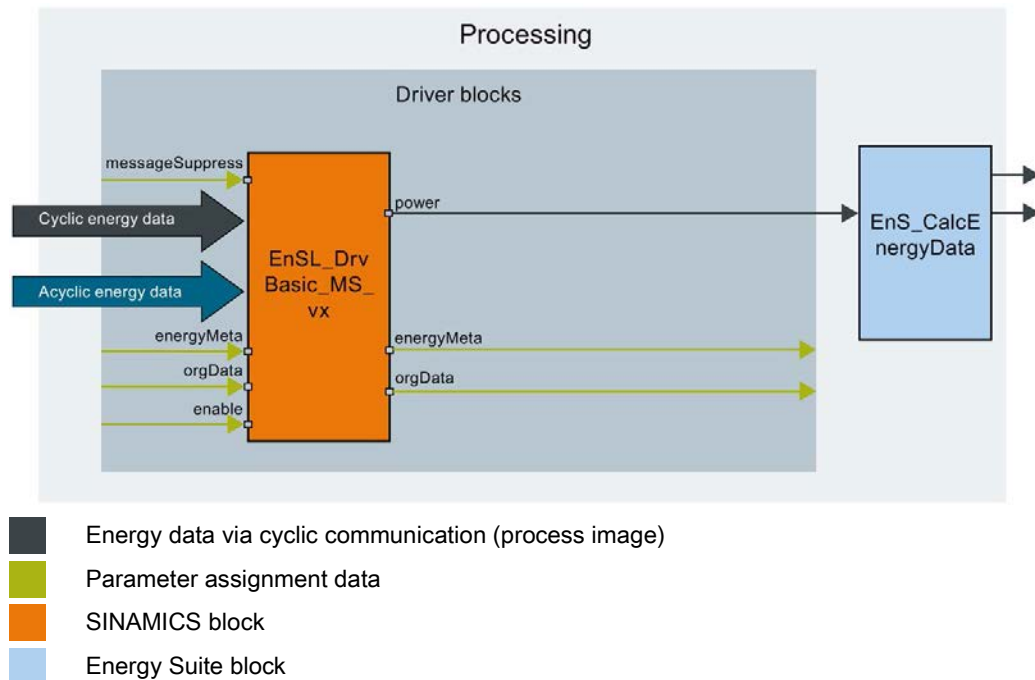

Hardware configuration and parameter assignment

The DQ ID of the drive is required at the "axisID" input of the "EnSL_DrvBasic_Sina_vx" driver block. The DQ ID contains the object number with which each drive object can be addressed. The DQ ID of the drive is read with the "Startdrive" tool from the CU parameters 101 and 978. For the SINAMICS of the device series G120, G130 and G150, the default value "1" of the parameter "axisID" is sufficient. For other SINAMICS device families, assign the value for the DQ ID to the parameter "axisID". Program the assignment in a block that was not generated during the generation of the energy program.

The measurement data are transferred cyclic from SINAMICS to the CPU via the process image. The "Additional data, PZD-2/2" telegram is required at a slot in the device overview for this purpose. The telegram is available in the hardware catalog when the "Filter" check box is selected under "Submodule".

Use the "Startdrive" tool to assign the parameters for the following settings:

The setting "r82[2]CO: "Active power value" is needed in the "PROFIdrive transmission direction settings". You can find the transmission direction settings in the project tree of the frequency converter under "Parameter" > Inspector window > "Function view" tab > "Communication" navigation area > Transmission direction > "PROFIdrive".

6.3.2 EnSL_DrvBasic_PAC_vx parameter

The table below shows the parameters of the ""EnSL_DrvBasic_Sina_vx"" block that related to the Energy Suite:

Parameter	Declaration	Data type	Preassigned value	Description
enable	Input	BOOL	FALSE	Processing enable
messageSup-press	Input	BOOL	FALSE	Message suppression
startAcyc	Input	BOOL	FALSE	TRUE = blocks passes through the startup routine again without restart of the CPU
power	Output	EnS_typeAnalogValue	-	Momentary value of the active power
status	Output	WORD	16#0000	Block status
orgData	InOut	EnS_typeOrgData	-	Organization data
energyMeta	InOut	EnS_typeEnergyMeta	-	Measuring-point-specific data

6.3.3 Status parameter

The table below shows the error codes that are output when errors occur at the "status" output parameter of the "EnSL_DrvBasic_Sina_vx" block:

Error code (W#16#...)	Description	Solution
8001	Connection with SINAMICS is interrupted / extended instruction "GETIO_PART" has failed	Establish a connection to the device. You can find additional information on error correction in the description of the extended instruction "GETIO_PART".
8002	"RDREC" extended instruction timeout	You can find additional information on error correction in the description of the extended instruction "RDREC".
8003	Reading data from SINAMICS has failed.	
8004	"WRREC" extended instruction timeout	You can find additional information on error correction in the description of the extended instruction "WRREC".
8005	Writing data to SINAMICS has failed.	
8008	"GETIO_PART" and "SETIO_PART" extended instructions have failed	You can find additional information on error correction in the description of the extended instruction "GETIO_PART" and "SETIO_PART". The error code of the instruction is contained in the "statusGETIO" and "statusSETIO" parameters.
8011	Energy flow direction invalid	Enter a valid value at the parameter for the energy flow direction.
8020	An error has occurred executing the startup routine	Launch the startup routine again with the "startAcyc" parameter. If the error occurs again, contact Customer Support or your Siemens representative.
8021	"axisID" parameter <= 0	You can find the DQ ID of the individual drive objects in the CU parameter 101 or 978.

6.3.4 Alarms

The alarms are generated with the "Program_Alarm" instruction. You can find additional information on "Program_Alarm" in the online help of the TIA Portal information system under "Advanced instructions > Alarms".

The table below shows the alarms of the function block "EnSL_DrvBasic_Sina_vx":

Alarm block	Alarm text	Alarm class
Program_Alarm	Connection lost	With acknowledgment

The message can be changed.

The alarm can be suppressed with "messageSuppress" or overridden with "orgData.messageSuppress" of the "EnS_Organization" function block.

SIMOCODE pro V PN

7.1 Description of SIMOCODE pro V PN

SIMOCODE pro V PN is a flexible, modular motor management system for motors with constant speed in the low-voltage range. The SIMOCODE pro V PN makes the measured energy data (power, energy, voltage, current etc.) available at its communications interface. The energy data can be read by the connected SIMATIC controller (for example, S7-1500) at the communications interface. The following section describes the driver blocks which enable simplified and standardized communication.

Integration in TIA Portal hardware catalog

The SIMOCODE pro V PN, also referred to as "SIMOCODE pro V" in the following, can be connected via PROFINET IO in the TIA Portal . To configure the hardware, use the user interface integrated in the TIA Portal.

A specific hardware configuration has to be set in order to use SIMOCODE pro V as energy data source in Energy Suite. You can find the required hardware configuration in the section "Hardware Configuration and Parameter Assignment (Page 99)".

Application

The supplied driver blocks for SIMOCODE pro V are contained in the global library of the "Energy Support Library".

The table below shows the driver blocks of SIMOCODE pro V:

Name	Function
EnSL_DrvBasic_SMCproV_vx	Driver block for SIMOCODE pro V for basic energy data
EnSL_DrvAdv_SMCproV_vx	Driver block for SIMOCODE pro V for advanced energy data
EnSL_DrvAdvMinMax_SMCproV_vx	Driver block for SIMOCODE pro V for advanced minimum and maximum values
EnSL_DrvAddReal_SMCproV_vx	Driver block for SIMOCODE pro V for additional energy data of the REAL type

7.2 Mode of operation of the driver blocks for SIMOCODE pro V

The driver blocks read the energy data from SIMOCODE pro V via cyclic or acyclic communication. You can find the general overview of the energy data processing in the section "Energy data processing based on the "IPO" principle (Page 14)".

The figure below shows the structure and the data flow of the SIMOCODE pro V blocks:

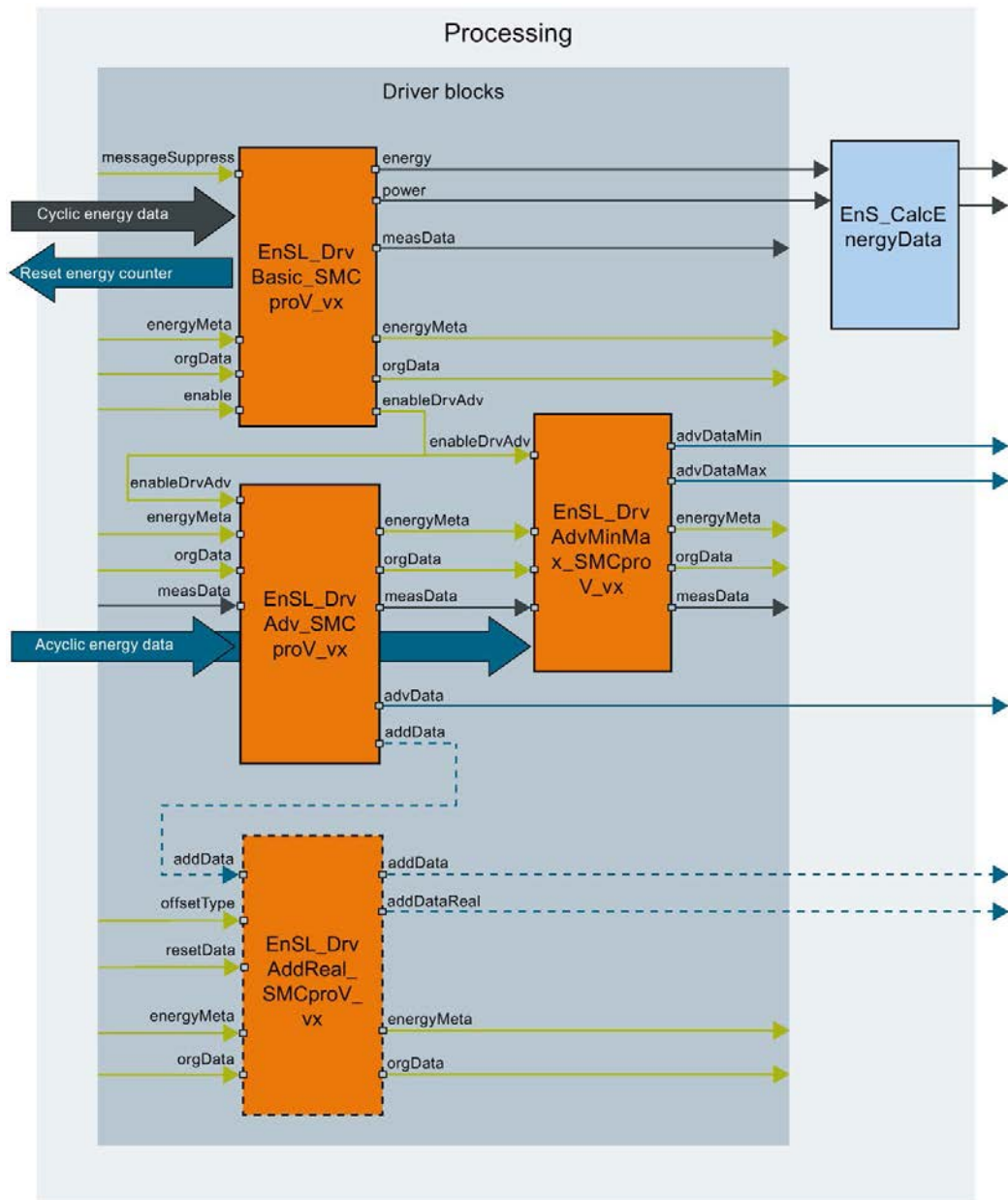

- Energy data via cyclic communication (process image)
- Energy data via acyclic communication (read/write data record)
- Parameter assignment data
- SIMOCODE pro V blocks
- Energy Suite blocks
- Required blocks
- Optional blocks

7.3 EnSL_DrvBasic_SMCproV_vx: Acquire basic energy data

7.3.1 Description of EnSL_DrvBasic_SMCproV_vx

The "EnSL_DrvBasic_SMCproV_vx" block reads the basic energy data (momentary active energy and momentary active power) from SIMOCODE pro V via the process image and transmits this data to the "EnS_CalcEnergyData" and "EnSL_DrvAdv_SMCproV_vx" blocks.

The figure below shows the mode of operation of the "EnSL_DrvBasic_SMCproV_vx" block:

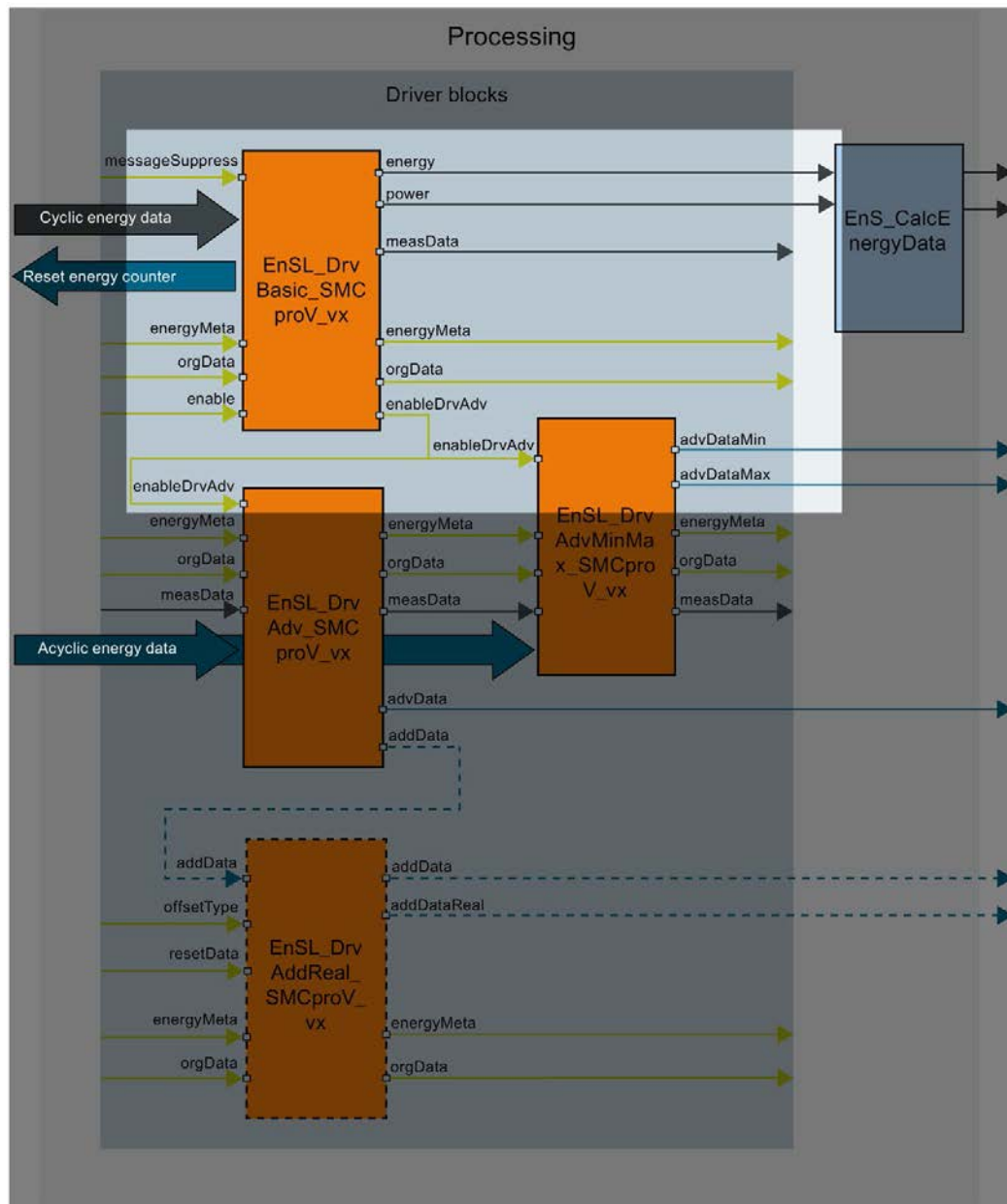

- Energy data via cyclic communication (process image)
- Energy data via acyclic communication (read/write data record)
- Parameter assignment data
- SIMOCODE pro V blocks
- Energy Suite blocks

Hardware configuration and parameter assignment

To transfer the energy data from SIMOCODE via the cyclic process data, replace the default current measuring module "IM 0.3 - 3A" set in your application by SIMOCODE with the corresponding IUM current/voltage measuring module, e.g. "IUM 10 – 100A".

The following figure shows the "IM 0.3 - 3A" current measuring module set by default:

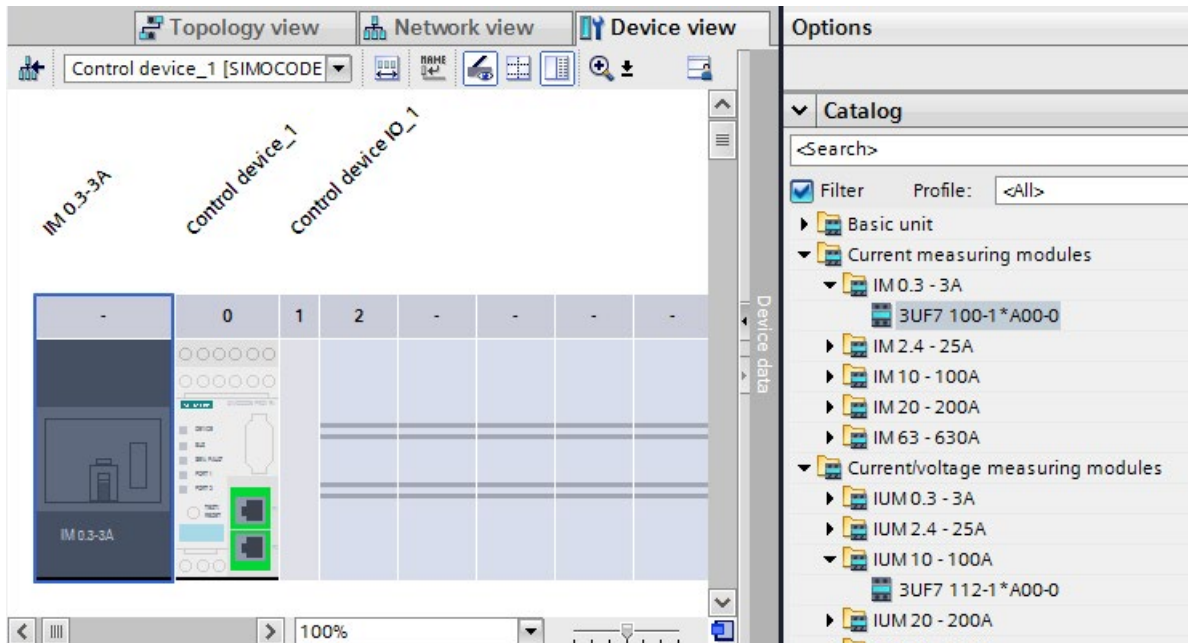

The figure below shows the corresponding IUM current/voltage detection module, e.g. "IUM 10 – 100A" in your application:

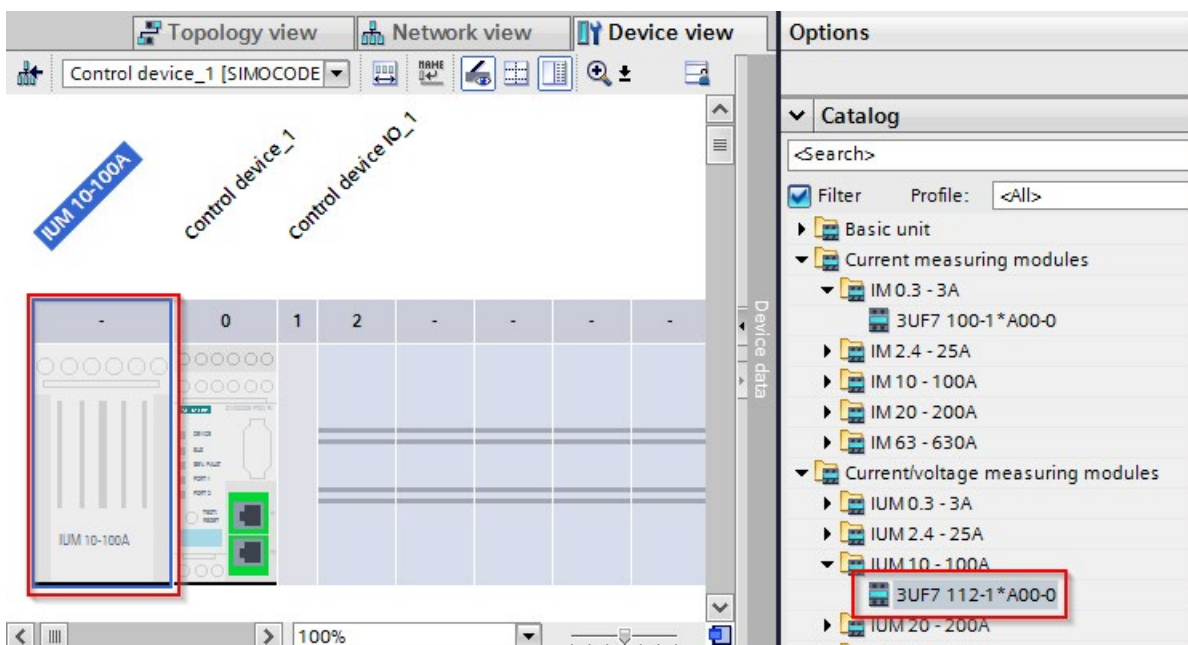

For communication via PROFINET IO, select basic type 3 at the SIMOCODE pro V in the inspector window "Properties" under "General > Module parameters > PROFINET parameters".

The following figure shows this parameter assignment:

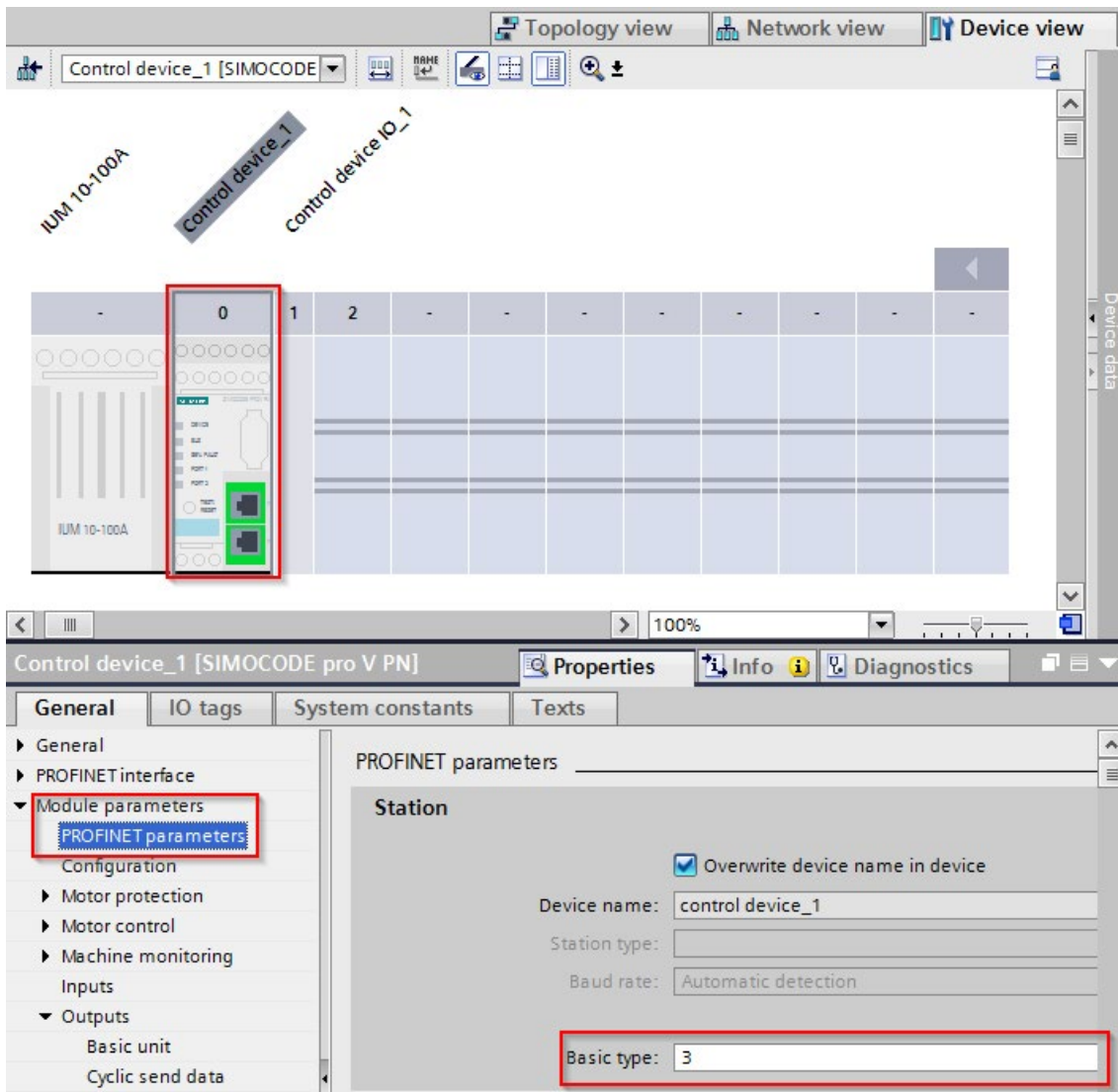

You can configure the selection of the cyclic energy data in the inspector window "Properties" under "General > Module parameters > Outputs > Cyclic send data". You configure the cyclic send data in the following sequence at the positions shown in the following figure:

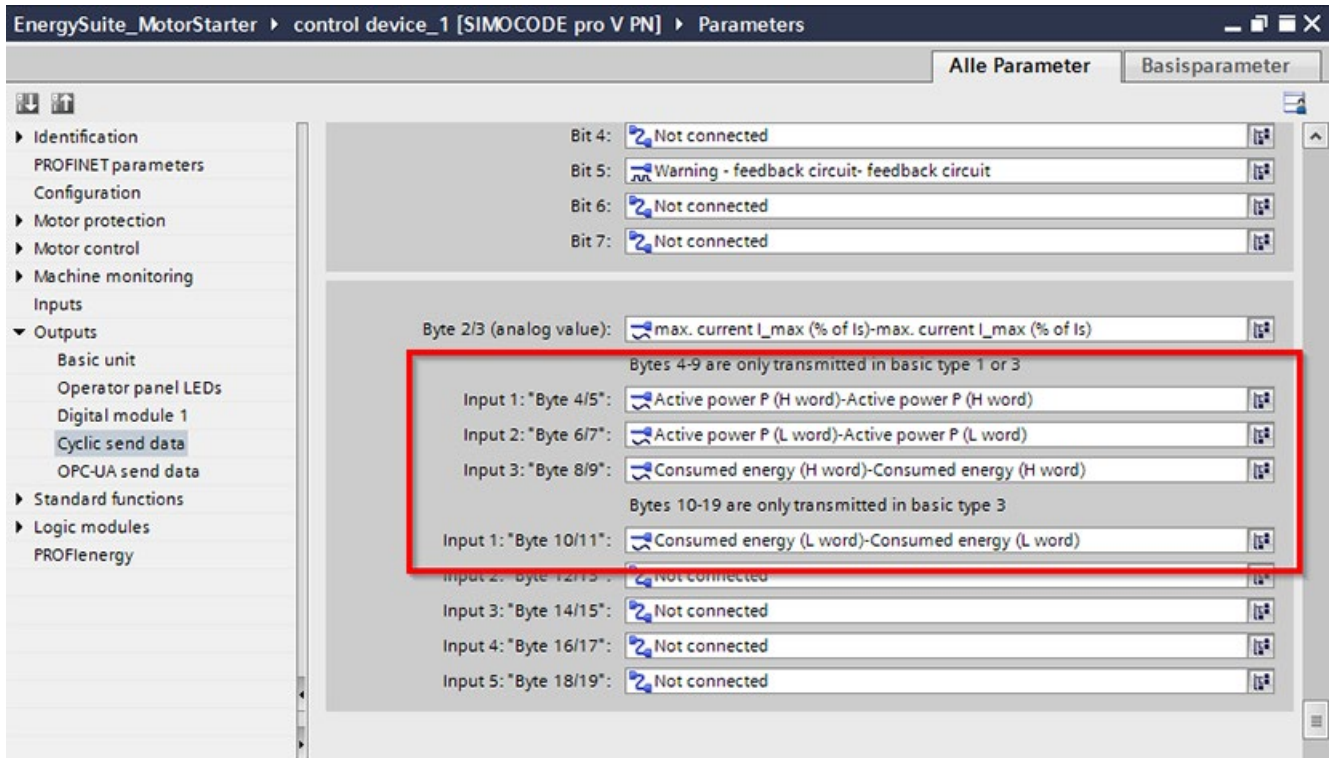

7.3.2 EnSL_DrvBasic_SMCproV_vx parameter

The table below shows the parameters of the "EnSL_DrvBasic_SMCproV_vx" block that are relevant for the Energy Suite:

Parameter	Declaration	Data type	Preassigned value	Description
enable	Input	BOOL	FALSE	TRUE = Processing enable
messageSup-press	Input	BOOL	FALSE	TRUE = Alarm suppression
energy	Output	EnS_typeEnergyCounter	-	Momentary value of the active energy counter
power	Output	EnS_typeAnalogValue	-	Momentary value of the active power
measData	Output	EnSL_typeAdvSMCproV (Page 115)	-	Cyclic measured values which are read from SIMOCODE pro V and transferred to the "EnSL_DrvAdv_3VA_vx" block as advanced energy data.
status	Output	WORD	-	Error status information (Page 104)
orgData	InOut	EnS_typeOrgData	-	Organization data
energyMeta	InOut	EnS_typeEnergyMeta	-	Measuring-point-specific data Extract of relevant parameters: <ul style="list-style-type: none"> energyMeta.mode energyMeta.normFactorIn energyMeta.inputType energyMeta.connectionType energyMeta.overflowCntValue

7.3.3 Status parameter

The table below shows the error codes which are output when errors occur at the "status" output parameter of the "EnSL_DrvBasic_SMCproV_vx" block:

Error code (W#16#...)	Description	Solution
8001	Connection with SIMOCODE pro V is interrupted / extended instruction "GETIO" has failed	Establish a connection to the measuring instrument. You can find additional information on error correction in the extended instruction "GETIO".
8002	Extended instruction "RDREC" timeout.	You can find additional information on error correction in the description of the extended instruction "RDREC".
8003	Reading data from SIMOCODE pro V has failed.	The error code of the instruction is contained in the "statusRDREC" parameter.
8004	Extended instruction "WRREC" timeout.	You can find additional information on error correction in the description of the extended instruction "WRREC".
8005	Writing data to SIMOCODE pro V has failed.	The error code of the instruction is contained in the "statusWRREC" parameter.
8008	Extended instruction "GETIO" has failed.	You can find additional information on error correction in the extended instruction "GETIO". The error code of the instruction is contained in the "statusGETIO" parameter.
8011	Energy flow direction invalid	Enter a valid value at the parameter for energy flow direction.

7.3.4 Alarms

If the connection to the SIMOCODE pro V is interrupted (status 16#8004), an alarm is output via the advanced instruction "Program_Alarm".

The table below shows the alarms of the "EnSL_DrvBasic_SMCproV_vx" block:

Alarm block	Alarm text	Alarm class
Program_Alarm	Connection lost	With acknowledgment

The alarm can be changed and configured in WinCC.

When the driver block is used in the Energy Suite , the alarm via the "EnS_Organization" function block can be centrally suppressed.

7.4 EnSL_DrvAdv_SMCproV_vx: Acquire advanced energy data

7.4.1 Description of EnSL_DrvAdv_SMCproV_vx

The "EnSL_DrvAdv_SMCproV_vx" block uses the acyclic data transfer of the Advanced energy data from SIMOCODE pro V. The advanced energy data (for example, phase currents, line conductor/phase voltages, power factor) are transferred to the output structure at the "EnS_EnergyDataAdv" function block.

The figure below shows the mode of operation of the "EnSL_DrvAdv_SMCproV_vx" block:

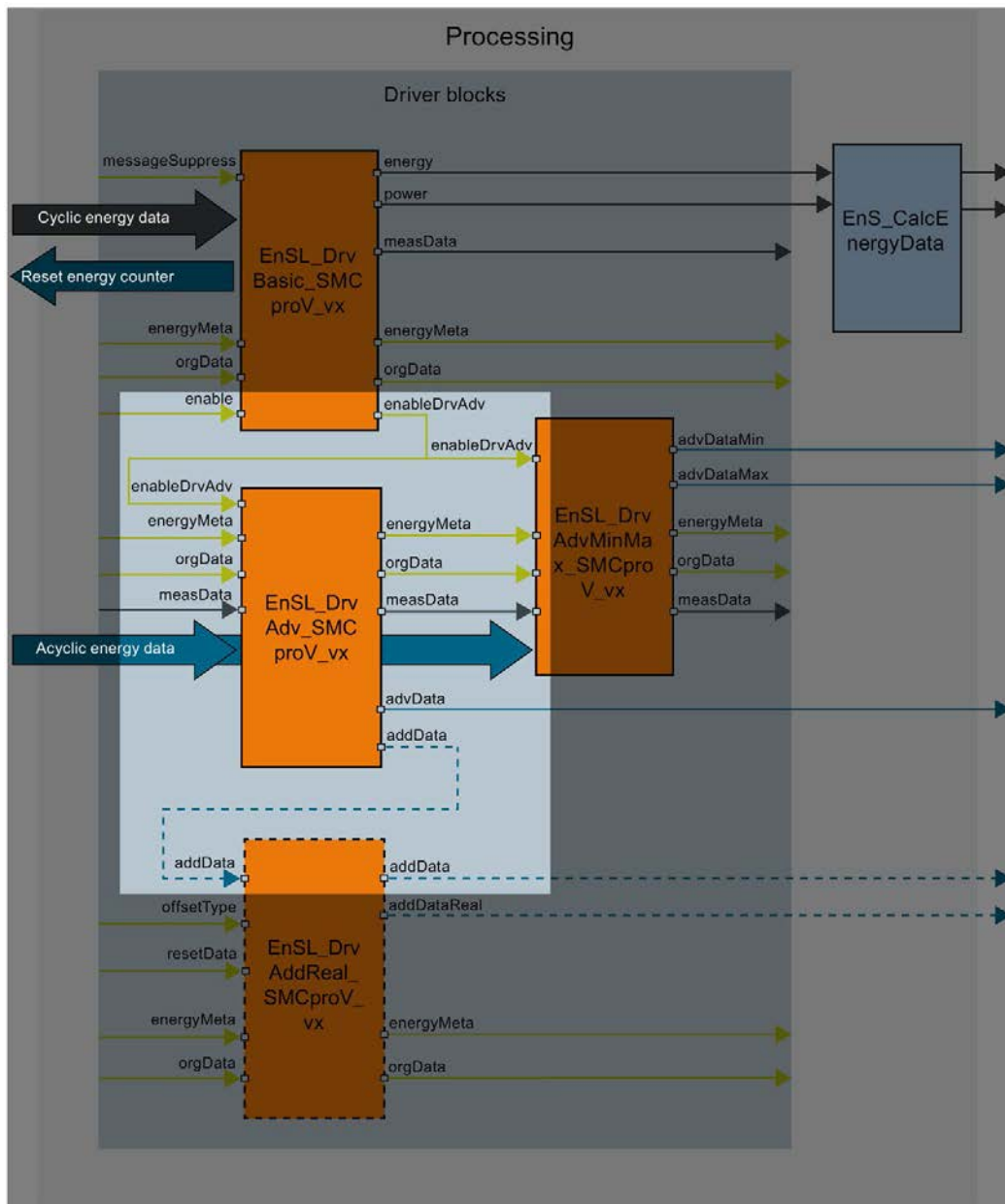

- Energy data via cyclic communication (process image)
- Energy data via acyclic communication (read/write data record)
- Parameter assignment data
- SIMOCODE pro V blocks
- Energy Suite blocks
- Required blocks
- Optional blocks

7.4.2 EnSL_DrvAdv_SMCproV_vx parameter

The table below shows the parameters of the "EnSL_DrvAdv_SMCproV_vx" block that are relevant for the Energy Suite:

Parameter	Declaration	Data type	Preassigned value	Description
enableDrvAdv	Input	BOOL	FALSE	TRUE = Processing enable Must be connected to the block "EnSL_DrvBasic_SMCproV_vx". If the connection to the SIMOCODE pro V is interrupted, all acyclic communicating driver blocks are disabled.
addData	Output	EnSL_typeAddSMCproV (Page 116)	-	Data transfer for the additional "EnSL_DrvAddReal_SMCproV_vx" block.
advData	Output	EnS_typeEnergyAdv	-	Advanced measurement data record Transferred to the "EnS_EnergyDataAdv" function block.
status	Output	WORD	16#0000	Error status information (Page 107)
energyMeta	InOut	EnS_typeEnergyMeta	-	Measuring-point-specific data

7.4.3 Status parameter

The following table shows the error codes that are generated at the "status" output parameter of the "EnSL_DrvAdv_SMCproV_vx" function block when errors occur:

Error code (W#16#...)	Description	Solution
8002	"RDREC" advanced instruction timeout	Additional information on error correction is available in the description of the advanced instruction "RDREC". The error code of the instruction is contained in the "statusRDREC" parameter.
8003	Reading data from SIMOCODE pro V has failed.	

7.5 EnSL_DrvAdvMinMax_SMCproV_vx: Acquire advanced minimum and maximum values

7.5.1 Description of EnSL_DrvAdvMinMax_SMCproV_vx

The "EnSL_DrvAdvMinMax_SMCproV_vx" block uses the acyclic data transfer of the Advanced energy data from SIMOCODE pro V. The advanced minimum and maximum values (for example, minimum current, minimum voltage) are transferred to the output structures at the "EnS_EnergyDataAdvMinMax" function block.

The figure below shows the mode of operation of the "EnSL_DrvAdvMinMax_SMCproV_vx" block:

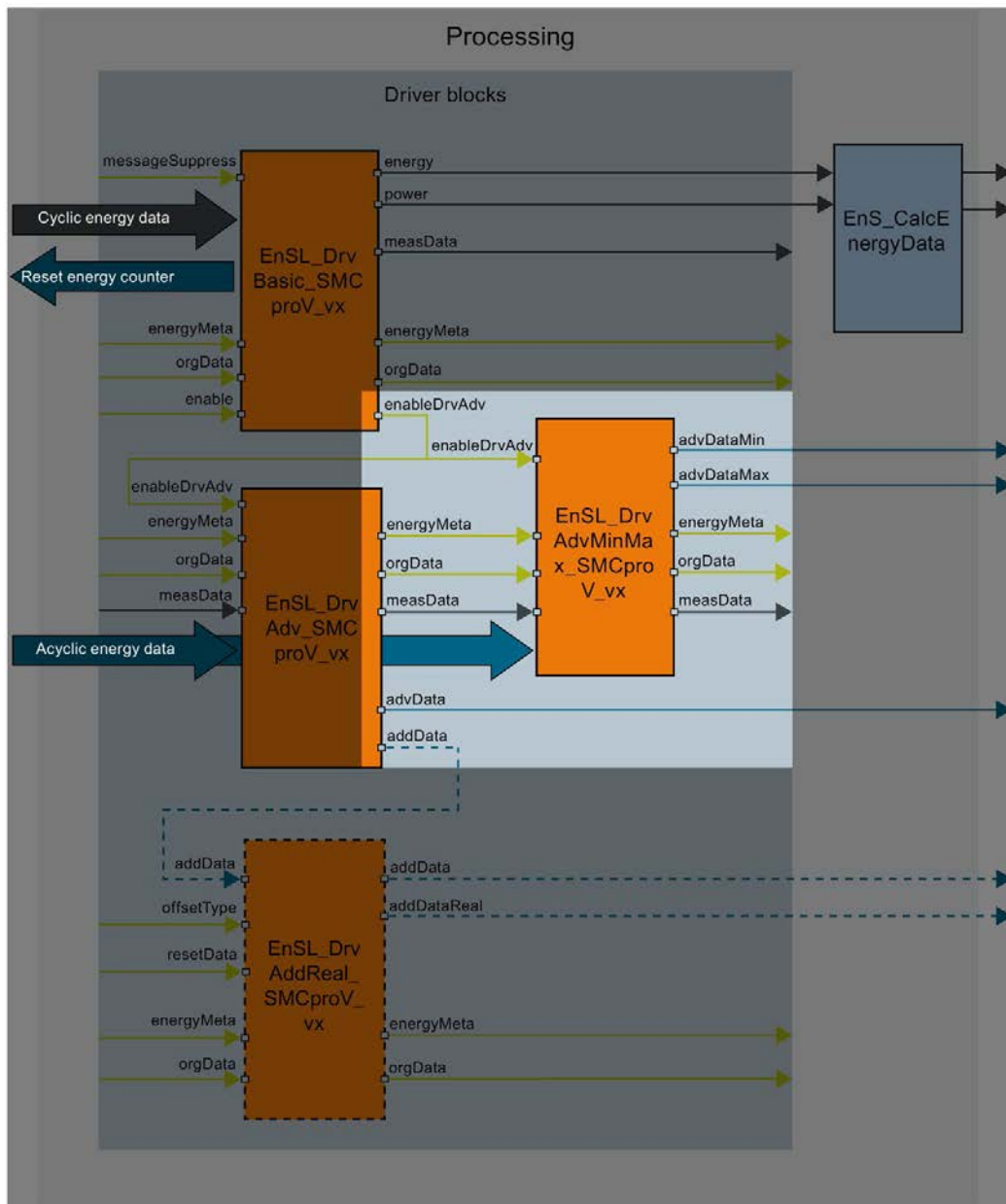

- Energy data via cyclic communication (process image)
- Energy data via acyclic communication (read/write data record)
- Parameter assignment data
- SIMOCODE pro V blocks
- Energy Suite blocks

7.5.2 EnSL_DrvAdvMinMax_SMCproV_vx parameter

The table below shows the parameters of the "EnSL_DrvAdvMinMax_3RR24_vx" block that are relevant for the Energy Suite:

Parameter	Declaration	Data type	Preassigned value	Description
enableDrvAdv	Input	BOOL	FALSE	TRUE = Processing enable Must be linked to the "EnSL_DrvBasic_SMCproV_vx" function block. If the connection to the SIMOCODE pro V is interrupted, all acyclic communicating driver blocks are disabled.
advDataMin	Output	EnS_typeEnergyAdv	-	Advanced measurement data record with minimum values Transferred to the "EnS_EnergyDataAdvMinMax" function block.
advDataMax	Output	EnS_typeEnergyAdv	-	Advanced measurement data record with maximum values Transferred to the "EnS_EnergyDataAdvMinMax" function block.
status	Output	WORD	-	Error status information (Page 109)
measData	InOut	EnSL_typeAdvSMCproV (Page 115)	-	Cyclic measured values which are read from SIMOCODE pro V and transferred to the "EnSL_DrvAdv_SMCproV_vx" block as advanced energy data.
orgData	InOut	EnS_typeOrgData	-	Organization data
energyMeta	InOut	EnS_typeEnergyMeta	-	Measuring-point-specific data

7.5.3 Status parameter

The table below shows the error codes which are output when errors occur at the "status" output parameter of the "EnSL_DrvAdvMinMax_SMCproV_vx" block:

Error code (W#16#...)	Description	Solution
8002	"RDREC" advanced instruction timeout	Additional information on error correction is available in the description of the advanced instruction "RDREC". The error code of the instruction is contained in the "statusRDREC" parameter.
8003	Reading data from 3VA has failed.	

7.6 EnSL_DrvAddReal_SMCproV_vx: Acquire additional energy data of REAL type

7.6.1 Description of EnSL_DrvAddReal_SMCproV_vx

The "EnSL_DrvAddReal_SMCproV_vx" block makes available Additional measured values of the type "REAL" (32-bit) via acyclic communication. You can read up to six different REAL values for each created instance of the block from SIMOCODE pro V .

7.6 EnSL_DrvAddReal_SMCproV_vx: Acquire additional energy data of REAL type

The figure below shows the mode of operation of the "EnSL_DrvAddReal_SMCproV_vx" block:

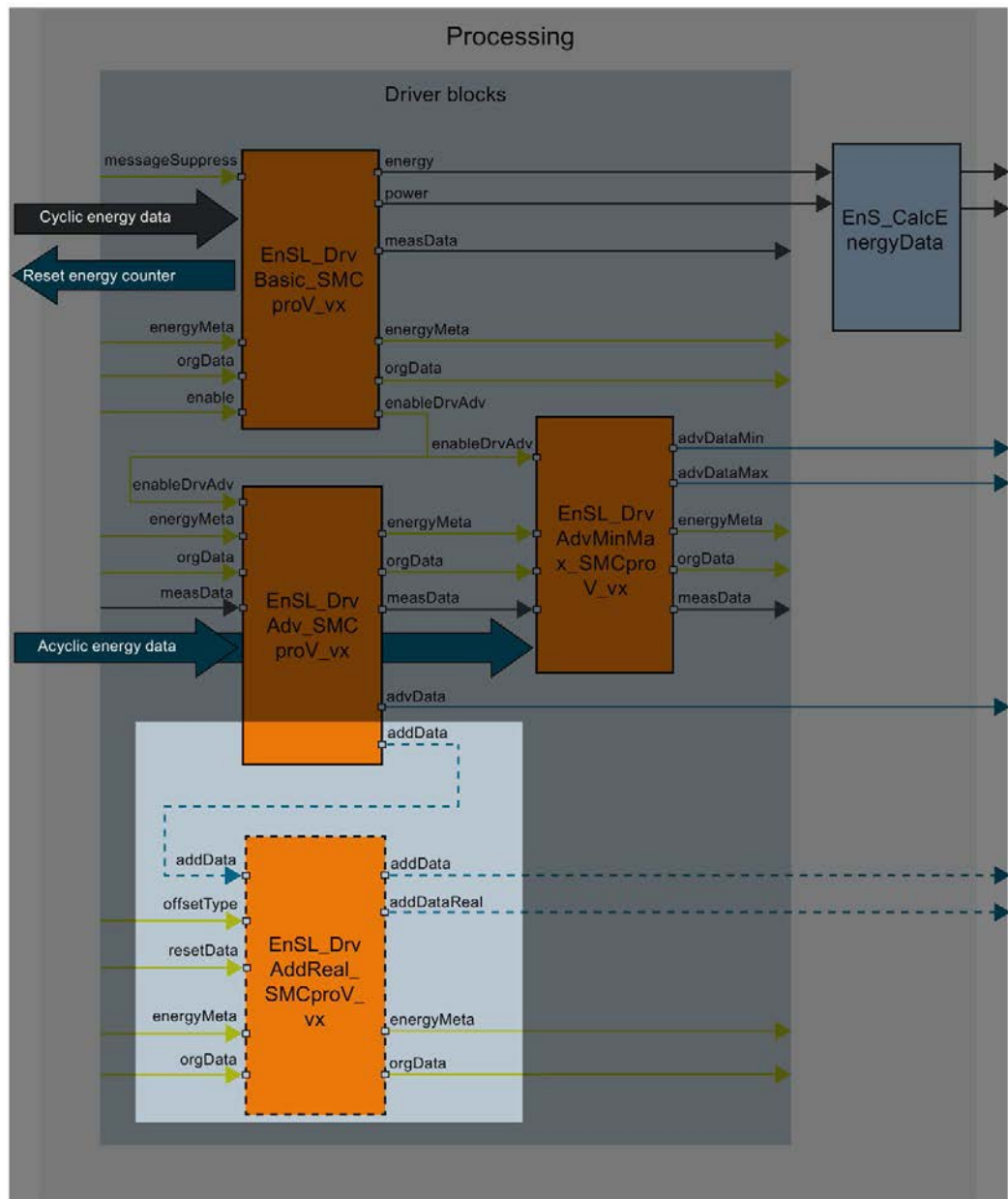

- █ Energy data via acyclic communication (read/write data record)
- █ Parameter assignment data
- █ SIMOCODE pro V blocks
- Required blocks
- Optional blocks

7.6.2 EnSL_DrvAddReal_SMCproV_vx parameter

The table below shows the parameters of the "EnSL_DrvAddReal_SMCproV_vx" block that are relevant for the Energy Suite:

Parameter	Declaration	Data type	Preassigned value	Description
offsetType	Input	INT	0	Offset value in the "energyMeta.typeAddValue" array Specifies the numerical value (number) starting at which the six follow-on "REAL" values are read from the "energyMeta.typeAddValue" array.
addDataReal	Output	EnS _typeEnergyAddReal	-	Momentary "REAL" data record Contains up to six "REAL" values which are made available in the "addDataReal.actValue" output structure.
status	Output	WORD	-	Error status information (Page 115)
addData	InOut	EnSL _typeAddSMCproV (Page 116)	-	Data transfer from the "EnSL_DrvAdv_SMCproV_vx" block
energyMeta	InOut	EnS _typeEnergyMeta	-	Measuring-point-specific data

Settings at the "offsetType" parameter

The value at the input parameter "offsetType" refers to the index of the array element "typeAddValue" of the user-defined data type "EnS_typeEnergyMeta". The default setting is "0". Enter a numerical value at the "offsetType" parameter (valid values: 0 - 19). The numerical value represents the position of a lower-level array element of "typeAddValue". Up to six follow-on values starting at the specified numerical value are read from SMCproV.

Example of the "offsetType" parameter

The figure below shows the block call of "EnSL_DrvAddReal_SMCproV_vx":

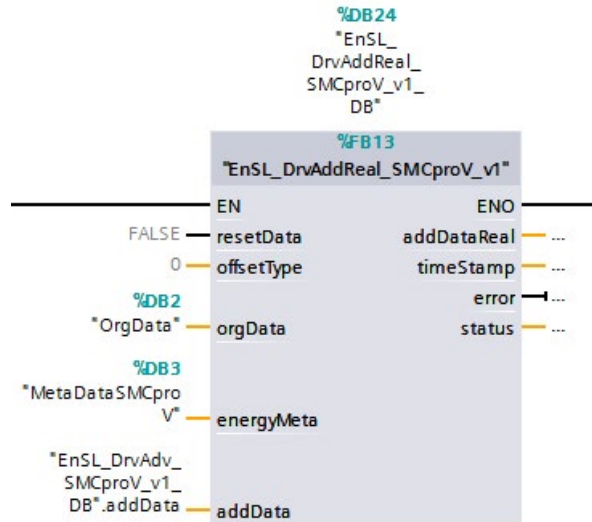

The value "0" is set at the "offsetType" parameter.

The figure below shows the entire "energyMeta.typeAddValue" array from the user-defined "EnS_typeEnergyMeta" data type:

Name	Data type	Start value
typeAddValue	Array[0..19] of UInt	
typeAddValue[0]	UInt	54
typeAddValue[1]	UInt	136
typeAddValue[2]	UInt	0
typeAddValue[3]	UInt	0
typeAddValue[4]	UInt	0
typeAddValue[5]	UInt	0
typeAddValue[6]	UInt	0
typeAddValue[7]	UInt	0
typeAddValue[8]	UInt	0
typeAddValue[9]	UInt	0
typeAddValue[10]	UInt	0
typeAddValue[11]	UInt	0
typeAddValue[12]	UInt	0
typeAddValue[13]	UInt	0
typeAddValue[14]	UInt	0
typeAddValue[15]	UInt	0
typeAddValue[16]	UInt	0
typeAddValue[17]	UInt	0
typeAddValue[18]	UInt	0
typeAddValue[19]	UInt	0

The "energyMeta.typeAddValue" array contains 20 elements of the type "UINT". Each of the elements has a start value which refers to the number of the measured value type. The measured value types can be arranged in any gap-less sequence in the "energyMeta.typeAddValue" array.

7.6 EnSL_DrvAddReal_SMCproV_vx: Acquire additional energy data of REAL type

Because the "offsetType" parameter has the value "0", the following two measured values are written in the "REAL" data record:

energyMeta.typeAddValue[0] = Start value 54: Amplitude unbalance for current

energyMeta.typeAddValue[1] = Start value 136: Max. conductor current

These two values are output at the "addDataReal" output of the block "EnSL_DrvAddReal_SMCproV_vx" and written in the corresponding instance data block.

The figure below shows the offline view of the "addDataReal" output with the two "REAL" values:

Name	Data type	Start value
addDataReal	"EnS_typeEnergyAddReal"	
actValue	Array[0..5] of "EnS_typeAddValueReal"	
actValue[0]	"EnS_typeAddValueReal"	
value	Real	0.0
type	UInt	0
actValue[1]	"EnS_typeAddValueReal"	
value	Real	0.0
type	UInt	0
actValue[2]	"EnS_typeAddValueReal"	
actValue[3]	"EnS_typeAddValueReal"	
actValue[4]	"EnS_typeAddValueReal"	
actValue[5]	"EnS_typeAddValueReal"	

The table below shows the possible measured values in the "addDataReal.actValue" output structure:

Number	Measured value type	Data type	Unit
54	Amplitude unbalance for current	REAL	%
136	Max. conductor current	REAL	A

7.6.3 Status parameter

The table below shows the error codes which are output when errors occur at the "status" output parameter of the "EnSL_DrvAddReal_SMCproV_vx" block:

Error code (W#16#...)	Description	Solution
8002	"RDREC" advanced instruction timeout	Additional information on error correction is available in the description of the advanced instruction "RDREC". The error code of the instruction is contained in the "statusRDREC" parameter.
8003	Reading data from SIMOCODE pro V has failed.	
8013	Incorrect data type This block supports only the "REAL" data type.	Select a "REAL" parameter.
8014	Incorrect offset value The limits (0 - 19) of the "energyMeta.typeAddValue" array from which the six "" values were read, have been exceeded.	Reduce the offset value.

7.7 User-defined data types (UDTs) of SIMOCODE pro V

7.7.1 EnSL_typeAdvSMCproV

7.7.1.1 Description of EnSL_typeAdvSMCproV

The PLC data type "EnSL_typeAdvSMCproV" contains measured values which are transferred to the block "EnSL_DrvAdv_SMCproV_vx".

7.7.1.2 Structure of EnSL_typeAdvSMCproV

The table below shows the parameters of the PLC data type "EnSL_typeAdvSMCproV":

Parameter	Data type	Preassigned value	Description
totalActPower	REAL	0.0	Momentary active power
actEnergyImp	REAL	0.0	Momentary active energy
status	WORD	-	Status of the process value

7.7.2 EnSL_typAddSMCproV

7.7.2.1 Description of EnSL_typeAddSMCproV

The PLC data type "EnSL_typeAddSMCproV" contains measured values which are transferred to the blocks "EnSL_DrvAddReal_SMCproV_vx".

7.7.2.2 Structure of EnSL_typeAddSMCproV

The table below shows the parameters of the PLC data type "EnSL_typeAddSMCproV":

Parameter	Data type	Preassigned value	Description
ampUnbalCurrent	BYTE	-	Amplitude unbalance current
maxConCurrent	WORD	-	Maximum active current
setCurent	REAL	0.0	Current setting
timeStamp	REAL	0.0	Time stamp
status	WORD	-	Status of the process value

ET 200SP/M200D Motor Starter

8.1 Description of ET 200SP/M200D Motor Starter

The SIMATIC ET 200SP Motor Starter and M200D Motor Starter, referred to below as "motor starter", monitor your plant, switch of a consumer, or reliably activate a switch. When using different applications – whether logistics systems, production machinery or machine tools – rely on the performance of the motor starter and the optimum protection of your motors and consumers.

Integration in TIA Portal hardware catalog

The motor starter can be integrated via PROFINET IO into the TIA Portal. To configure the hardware, use the user interface integrated in the TIA Portal.

A specific hardware configuration has to be set in order to use the motor starter as energy data source in Energy Suite. You can find the required hardware configuration in the section "Hardware Configuration and Parameter Assignment (Page 119)".

Application

The supplied driver block for motor starters is contained in the global library of the "Energy Support Library".

The following table shows the driver block for motor starters:

Name	Function
EnSL_DrvBasic_MS_vx	Driver block for SIMATIC ET 200SP Motor Starter and M200D Motor Starter

8.2 Mode of operation of the driver blocks for ET 200SP/M200D Motor Starters

The driver block reads the energy data from the motor starter using cyclic and acyclic communication. You can find the general overview of the energy data processing in the section "Energy data processing based on the "IPO" principle (Page 14)".

The following figure shows the structure and data flow of the motor starter block:

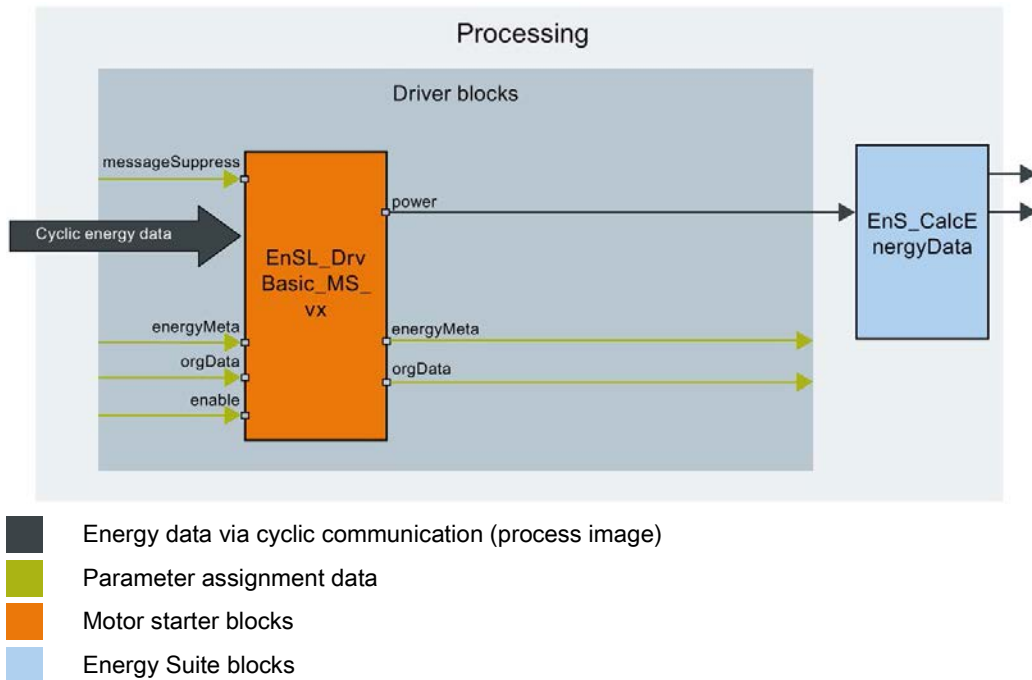

8.3 EnSL_DrvBasic_MS_vx: Acquiring basic energy data

8.3.1 Description of EnSL_DrvBasic_MS_vx

The "EnSL_DrvBasic_MS_vx" driver block reads the basic energy data from the motor starter and transfer this basic energy data to the "EnS_CalcEnergyData" block. This basic energy data is: Current power consumption.

The following figure shows the mode of operation of the "EnSL_DrvBasic_MS_vx" block:

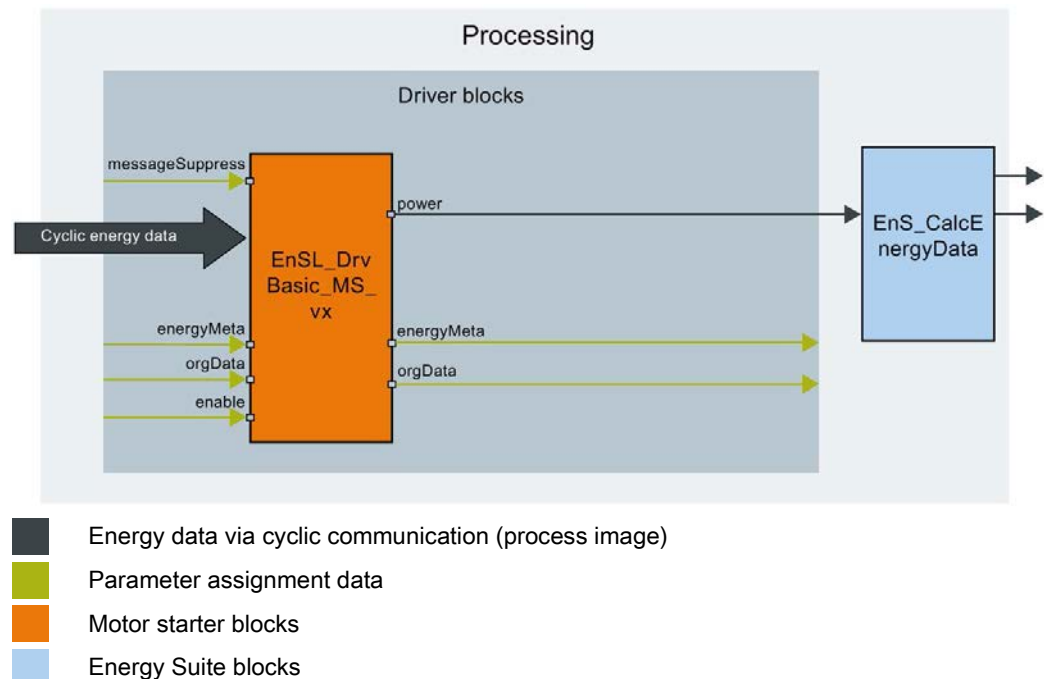

Hardware configuration and parameter assignment

The measured data are transferred cyclically via the process image from the motor starter to the CPU.

The following figure shows the configuration of the SIMATIC ET 200SP Motor Starter in the device overview:

Device overview				
Module	Type	Article number	Firmware	
▼ IO device	IM 155-6 PN HF	6ES7 155-6AU00-0CNO	V3.3	
▶ PROFINET interface	PROFINET interface			
RS 0.3 - 1A HF 3DI/LC_1	RS 0.3 - 1A HF 3DI/LC	3RK1 308-0BB00-0CP0	V1.0	

The following figure shows the HW ID of the SIMATIC ET 200SP Motor Starter in the Inspector window "System constants":

Name	Typ	HW-Kennung
IO-Device~RS_0_3_-_1A_HF_3DI_LC_1	Hw_SubModule	276

The PROFINET communication module is also required for the M200D Motor Starter. You can find this in the hardware catalog under "Drives & Starters > SIRIUS Motor Starters and Soft Starters > M200D Motor Starter > Communication Module".

The figure below shows the configuration of the MD200D Motor Starter in the device overview:

Device overview				
Module	Type	Article no.	Firmware	
▼ M200D PN-Kommunikationsmodul	M200D PN communication module	3RK1 335-0AS01-0AA0	V41.0	
▶ PROFINET-Schnittstelle_1	PROFINET interface			
▼ Starter	RSte 4DI/2DO/BO 2A	3RK1 395-6KS41-3AD5	V1.0	

The following figure shows the HW ID of the MD200D Motor Starter in the Inspector window "System constants":

Name	Typ	HW-Kennung
Starter_1-Proxy	Hw_SubModule	280

- When you use the SIMATIC ET 200SP Motor Starter, enter the value "0" at the "decPeriphery" parameter.
- When you use the M200D Motor Starter, enter the value "1" at the "decPeriphery" parameter.
- If the actual voltage of the motor starter differs from the voltage value of 230 V for single-phase systems or 400 V for three-phase systems, enter the actual voltage value of the motor starter at the "voltage" parameter.
- If the cos phi value of the motor differs from 0.8, enter the actual cos phi value of the motor starter at the "cosPhi" parameter.

Note

For dynamic voltages and dynamic cos phi of the motor starter, the static value at the "voltage" or "cosPhi" is corrupt.

In such cases, use a tag which is assigned to the dynamic voltage or dynamic cos phi of the motor starter and is interconnected to the "voltage" or "cosPhi" parameter.

8.3.2 EnSL_DrvBasic_MS_vx parameter

The table below shows the parameters relevant to Energy Suite from the "EnSL_DrvBasic_MS_vx" block:

Parameter	Declaration	Data type	Preassigned value	Description
enable	Input	BOOL	FALSE	Processing enable
messageSup-press	Input	BOOL	FALSE	Message suppression
startAcyc	Input	BOOL	FALSE	TRUE = blocks passes through the startup routine again without restart of the CPU
power	Output	EnS_typeAnalogValue	-	Momentary value of the active power
status	Output	WORD	16#0000	Block status
orgData	InOut	EnS_typeOrgData	-	Organization data
energyMeta	InOut	EnS_typeEnergyMeta	-	Measuring-point-specific data

8.3.3 Status parameter

The table below shows the error codes that are generated at the "status" output parameter of the "EnSL_DrvBasic_MS_vx" block when errors occur:

Error code (W#16#...)	Description	Solution
8001	Connection with the motor starter is interrupted / extended instruction "GETIO" has failed.	Establish a connection to the device. You can find additional information on error correction in the extended instruction "GETIO".
8002	Extended instruction "RDREC" timeout.	You can find additional information on error correction in the description of the extended instruction "RDREC".
8003	Reading data from the motor starter has failed.	
8004	Extended instruction "WRREC" timeout.	You can find additional information on error correction in the description of the extended instruction "WRREC".
8005	Writing data to motor starter has failed.	
8008	Extended instruction "GETIO" has failed.	You can find additional information on error correction in the extended instruction "GETIO". The error code of the instruction is contained in the "statusGETIO" parameter.
8015	Incorrect distributed I/O selected.	Specify the I/O used.
8016	"voltage" < 0.0 or "cosPhi" <= 0 or "cosPhi" > 1.	Specify a valid value for "voltage" and/or "cosPhi".
8020	The device signals an error (see device status). Possible causes: Incorrect data has been read from motor starter.	Reading is repeated until it is successful.

8.3.4 Alarms

The alarms are generated with the "Program_Alarm" instruction. You can find additional information on "Program_Alarm" in the online help of the TIA Portal information system under "Advanced instructions > Alarms".

The following table shows the messages of the "EnSL_DrvBasic_MS_vx" function block:

Alarm block	Alarm text	Alarm class
Program_Alarm	Connection lost	With acknowledgment

The message can be changed.

The alarm can be suppressed with "messageSuppress" or overridden with "orgData.messageSuppress" of the "EnS_Organization" function block.

3RW44 Soft Starter

9.1 Description of 3RW44 Soft Starter

The 3RW44 Soft Starter, referred to below as "soft starter", limits the starting current and the starting torque of the motor. Both mechanical loads and supply voltage failures can be reliably avoided with this starter. The motor voltage is thereby reduced by phase shift and increased from an adjustable starting voltage to the mains voltage within a ramp time. The motor is adapted to the load response of the production machine by stepless control of the power supply.

The soft starter supplies the measured energy data (e.g. power, energy, voltage, current) to its communication interface. The energy data can be read by the connected SIMATIC controller (for example, S7-1500) at the communications interface. The following section describes S7 function blocks with driver functionality that enable simplified and standardized communication.

Integration in TIA Portal hardware catalog

The soft starter can be integrated via PROFINET IO into the TIA Portal. To configure the hardware, use the user interface integrated in the TIA Portal.

A specific hardware configuration has to be set in order to use the soft starter as energy data source in Energy Suite. You can find the required hardware configuration in the section "Hardware Configuration and Parameter Assignment (Page 125)".

Application

The supplied driver block from the soft starter for is contained in the global library of the "Energy Support Library".

The table below show the driver block from the soft starter:

Name	Function
EnSL_DrvBasic_3RW44_vx	Driver block for soft starter for basic energy data

9.2 Mode of operation of the driver blocks for 3RW44 Soft Starter

The driver block reads the energy data from the soft starter using cyclic and acyclic communication. You can find the general overview of the energy data processing in the section "Energy data processing based on the "IPO" principle (Page 14)". The following figure shows the structure and data flow of the soft starter block:

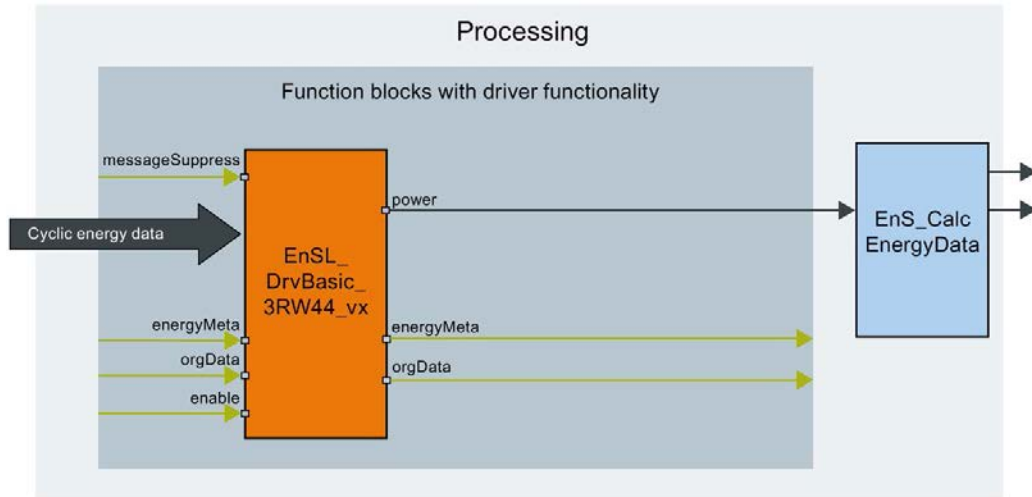

- Energy data via cyclic communication (process image)
- Parameter assignment data
- Soft starter blocks
- Energy Suite blocks

9.3 EnSL_DrvBasic_3RW44_vx: Acquiring basic energy data

9.3.1 Description EnSL_DrvBasic_3RW44_vx:

The "EnSL_DrvBasic_3RW44_vx" driver block reads the basic energy data from the soft starter and transfers the basic energy data to the "EnS_CalcEnergyData" block. This basic energy data is: Momentary power consumption.

The figure below shows the mode of operation of the "EnSL_DrvBasic_3RW44_vx" block:

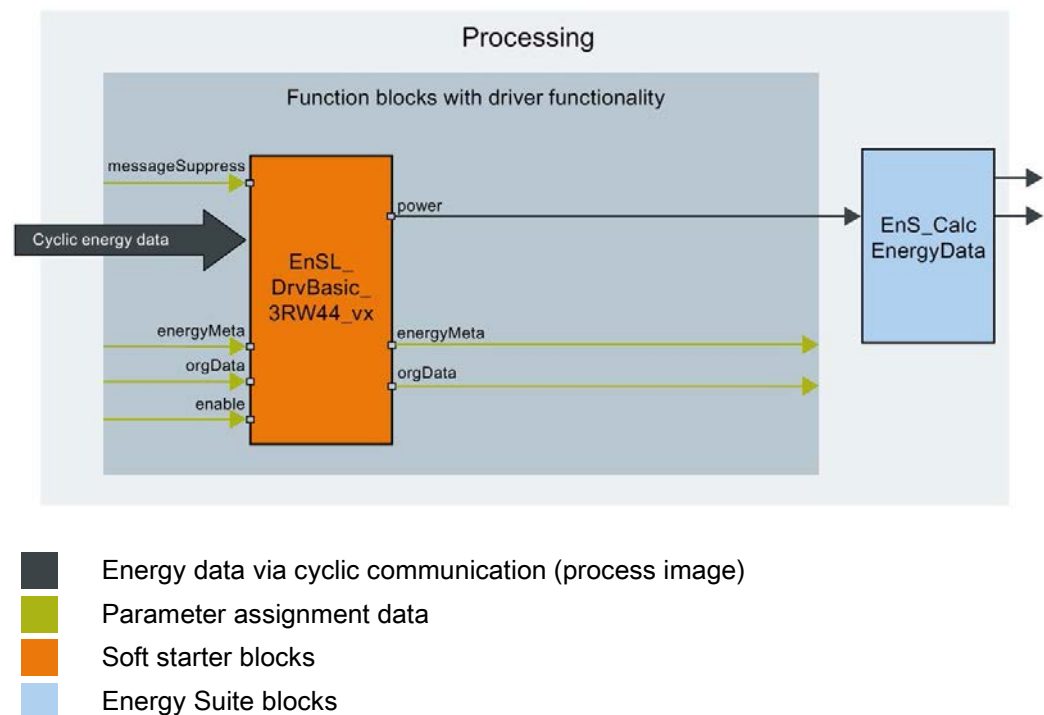

Hardware configuration and parameter assignment

The measured data are transferred cyclically via the process image from the soft starter to the CPU.

The PROFINET communication module is also required for the soft starter. You can find this in the hardware catalog under "Drives & Starters > SIRIUS Motor Starters and Soft Starters > Soft Starter > Communication Module".

The figure below shows the configuration of the soft starter in the device overview:

Device overview						
Module	I address	Q address	Type	Article no.	Firmware	
<ul style="list-style-type: none"> ▼ 3RW PN communication module_1 ▶ PROFINET interface_1 			3RW PN communication module	3RW4900-0NC00	V2.0	
Starter_1			DSSte 4DI/4DO 29A	3RW4 422-*BC**	V1.11	

The following figure shows the employed hardware identifier of the soft starter in the Inspector window "System constants":

Name	Typ	HW-ID
Starter_1~Proxy	Hw_SubModule	258

If the actual voltage of the soft starter differs from the voltage value of 400 V, enter the actual voltage value of the soft starter at the "voltage" parameter.

If the cos phi value of the motor differs from 0.8, enter the actual cos phi value of the soft starter at the "cosPhi" parameter.

Note

For dynamic voltages and dynamic cos phi of the soft starter, the static value at the "voltage" or "cosPhi" is corrupt.

In such cases, use a tag which is assigned to the dynamic voltage or dynamic cos phi of the soft starter and is interconnected to the "voltage" or "cosPhi" parameter.

9.3.2 Parameter EnSL_DrvBasic_3RW44_vx

The table below shows the parameters relevant to Energy Suite from the "EnSL_DrvBasic_3RW44_vx" block:

Parameter	Declaration	Data type	Preassigned value	Description
enable	Input	BOOL	FALSE	Processing enable
messageSuppress	Input	BOOL	FALSE	Alarm suppression
startAcyc	Input	BOOL	FALSE	TRUE = blocks passes through the startup routine again without restart of the CPU
power	Output	EnS_typeAnalogValue	-	Momentary value of the active power
status	Output	WORD	16#0000	Block status
orgData	InOut	EnS_typeOrgData	-	Organization data
energyMeta	InOut	EnS_typeEnergyMeta	-	Measuring-point-specific data

9.3.3 Parameter status

The table below shows the error codes that are output when errors occur at the "status" output parameter of the "EnSL_DrvBasic_3RW44_vx" block:

Error code (W#16#...)	Description	Solution
8001	Connection with the soft starter is interrupted / extended instruction "GETIO" has failed.	Establish a connection to the device. You can find additional information on error correction in the extended instruction "GETIO".
8002	Extended instruction "RDREC" timeout.	You can find additional information on error correction in the extended instruction "RDREC".
8003	Reading data from the soft starter has failed.	
8004	Extended instruction "WRREC" timeout.	You can find additional information on error correction in the extended instruction "WRREC".
8005	Writing data to soft starter has failed.	
8008	Extended instruction "GETIO" has failed.	You can find additional information on error correction in the extended instruction "GETIO". The error code of the instruction is contained in the "statusGETIO" parameter.
8016	"voltage" < 0.0 or "cosPhi" <= 0 or "cosPhi" > 1.	Specify a valid value for "voltage" and/or "cosPhi".
8020	The device signals an error (see device status). Possible causes: Incorrect data has been read from soft starter.	Reading is repeated until it is successful.

9.3.4 Alarms

The alarms are generated with the "Program_Alarm" instruction. You can find additional information on "Program_Alarm" in the online help of the TIA Portal information system under "Advanced instructions > Alarms".

The following table shows the alarms of the "EnSL_DrvBasic_3RW44_vx" function block:

Alarm block	Alarm text	Alarm class
Program_Alarm	Connection lost	With acknowledgment

The alarm can be changed.

The alarm can be suppressed with "messageSuppress" or overridden with "orgData.messageSuppress" of the "EnS_Organization" function block.